



Table of Contents

COMMERCIAL PRODUCTS

Parallel Speaker Wire	1
SPT Zip Cord	1
Alarm and Security Cables	
Burglar Alarm	2
Unshielded Multi-Conductor	2 - 4
Intercom Cable	
Unshielded Solid Pairs	5
Sound and Intercom Cable	
Unshielded Stranded Pairs	5
Shielded Pairs	6
Unshielded Solid Pairs	7
Audio and Data Cable	
Shielded Pairs	7
Shielded Multi-Conductor	8 - 9
Fire Alarm Cable	
Parallel	10
Shielded Multi-Conductor	10
Unshielded Multi-Conductor	11
Inside Telephone Multi-Pair	
Category 1 Unshielded Pairs	12
Category 1 Overall Shield	13
Category 3 Unshielded Pairs	14
Category 4 Unshielded Pairs	15
Category 5 Unshielded Pairs	16
Category 5 Overall Shield	17
Air Plenum	
Unshielded Multi-Conductor	18
Shielded Multi-Conductor	19
Shielded Pairs	20
Inside Telephone Multi-Pair Category 1 Unshielded Pairs	20 - 21
Inside Telephone Multi-Pair Category 1 Overall Shield	21
Inside Telephone Multi-Pair Category 3 Unshielded Pairs	22
Inside Telephone Multi-Pair Category 4 Unshielded Pairs	23
Inside Telephone Multi-Pair Category 5 Unshielded Pairs	24
Inside Telephone Multi-Pair Category 5 Overall Shield	25
Sound and Intercom Shielded Pairs	26
Unshielded Fire Alarm Cable	26
Shielded Fire Alarm Cable	27
Microminim [®]	
Ultra-Flex Micro-Miniature Wire & Cable	27

California

1959 East Cashdan Street, Rancho Dominguez, CA 90220
(310) 609-1811 • (800) 326-0006 • FAX: (310) 609-1862
E-Mail: salesrd@std-wire.com

Arizona

3120 West Thomas Road, Bldg. #801, Phoenix, AZ 85017
(602) 269-2501 • (800) 325-6478 • FAX: (602) 278-7134
E-Mail: salesphx@std-wire.com



Standard Wire & Cable Co.

Coaxial Cable	
Commercial Type	28
Air Plenum	29
CATV-CCTV	30
Thinnet	30
Precision Video	31
Twinax Cable	31
National Electric Code	32
Color Code Charts	33
Traffic Signal Cable	
Cal-Trans Loop Detector Lead-In Cable	34
Inductance Loop Detector Wire DETECTA-DUCT®	34
Retractable Cords	
Flexoprene®	35
PVC Communication & Electronic Control Cords	36
Heavy Duty Outdoor Use - Communication & Electronic Control Cords	36
Shielded Communication Cords	37
Test Lead	37
Rubber Portable Flexible Cord	
Type SJ	38
Electric Welding Cable Flexoprene®	38
Neoprene® Portable Flexible Cord	
Type SO	39
Types SVO & SJO	39
Polyvinylchloride (PVC) Insulated UL/CSA Hook-Up Wire	
UL Style 1007, CSA TR-64	40
UL Style 1015, CSA TEW	40
UL Style 1028, CSA TEW	41
UL Style 1061, CSA AWM	41
Appliance Lead Wire for High Temperature	
TAGT/TGGT	42
Appliance, Fixture, Apparatus, and Motor Lead Wire	
SRML	43

MIL SPEC PRODUCTS

Instrumentation Control Cable	44 - 45
Instrumentation Control Cable with Overall Shield	46 - 47
Multiple Pair Control Cable, Each Pair Shielded	48 - 49
Tinned Copper Flexible Braid QQ-B-575	50
Bare Solid Soft Drawn Copper Wire QQ-W-343	51
Tinned Solid Soft Drawn Copper Wire QQ-W-343	51
Electrical & Electronic Instrument Wire	
MIL-W-16878/1	52
MIL-W-16878/2	52
MIL-W-16878/17	52
MIL-W-16878/18	52
MIL-W-16878/3	53
MIL-W-16878/19	53

California

1959 East Cashdan Street, Rancho Dominguez, CA 90220
(310) 609-1811 • (800) 326-0006 • FAX: (310) 609-1862
E-Mail: salesrd@std-wire.com

Arizona

3120 West Thomas Road, Bldg. #801, Phoenix, AZ 85017
(602) 269-2501 • (800) 325-6478 • FAX: (602) 278-7134
E-Mail: salesphx@std-wire.com



Standard Wire & Cable Co.

Shielded & Jacketed Electrical & Electronic Instrument Wire		
Single Conductor	54	
Two Conductor	55	
Three Conductor	56	
Four Conductor	57	
Extruded Teflon® Hook-Up Wire		
MIL-W-16878E/4 Type E	58	
MIL-W-16878E/5 Type EE	59	
MIL-W-16878E/6 Type ET	60	
MIL-W-16878 Rev. F Supersession of Duplicate Strandings to MIL-W-22759	61	
MIL-W-16878 Cable Designation		
Specification Number	62	
Conductor Material	63	
Color Code	63	
Conductor Size	63	
Conductor Stranding	63	
Class H Shielded & Jacketed Miniature Cables		
Single Conductor	64	
Two Conductor	65	
Three Conductor	65	
Four Conductor	66	
MIL-C-13486		
Type I, Class A Cable, Special Purpose, Electrical, Low Tension	67	
Flexible Strand		
Pigtail	68	
Special Purpose Miniature Flexible Cables		68
Antenna Wire		69
Test Lead Wire		
Stanflex®	69	
MIL-W-8777C (ASG) MS 25471 (ASG)		70
MS 27110 (ASG)		71
MIL-W-25038/1		72
MIL-W-25038/3		72
MIL-W-22759/1		73
MIL-W-22759/2		73
MIL-W-22759/3		74
MIL-W-22759/4 MS 90294		75
MIL-W-22759/5		76
MIL-W-22759/6		76
MIL-W-22759/7		77
MIL-W-22759/8		77
MIL-W-22759/9		78
MIL-W-22759/10		78
MIL-W-22759/11		79
MIL-W-22759/12		79
MIL-W-22759/16		80
MIL-W-22759/18		80
MIL-W-22759/20		81
MIL-W-22759/21		81
MIL-W-22759/22		82
MIL-W-22759/23		82
MIL-W-22759/32		83

California

1959 East Cashdan Street, Rancho Dominguez, CA 90220
 (310) 609-1811 • (800) 326-0006 • FAX: (310) 609-1862
 E-Mail: salesrd@std-wire.com

Arizona

3120 West Thomas Road, Bldg. #801, Phoenix, AZ 85017
 (602) 269-2501 • (800) 325-6478 • FAX: (602) 278-7134
 E-Mail: salesphx@std-wire.com



Standard Wire & Cable Co.

MIL-W-22759/33	83
MIL-W-22759/34	84
MIL-W-22759/35	84
MIL-W-22759/41	85
MIL-W-22759/42	85
MIL-W-22759/43	86
MIL-W-22759/44	86
MIL-W-22759/45	87
MIL-W-22759/46	87
MIL-W-22759/80A	88
MIL-W-22759/81A	88
MIL-W-22759/82A	89
MIL-W-22759/83A	89
MIL-W-22759/84A	90
MIL-W-22759/85A	90
MIL-W-22759/86A	91
MIL-W-22759/87A	92
MIL-W-22759/88A	93
MIL-W-22759/89A	94
MIL-W-22759/90A	94
MIL-W-22759/91A	95
MIL-W-22759/92A	95
MIL-W-81044/9	96
MIL-W-81044/12	97
MIL-W-81044/13	97
MIL-W-81381/7	98
MIL-W-81381/8	98
MIL-W-81381/9	99
MIL-W-81381/11	99
MIL-W-81381/12	100
MIL-W-81381/13	100
MIL-W-81381/17	101
MIL-W-81381/21	101
MIL-W-81381/22	102
Military Cable Designation (M27500)	
Cable Description	103
Table I - Basic Wire Specifications	104
Table IA - Shield Material	104
Table IB - Jacket Material and Color	105
Table II - Allowable Shield and Jacket Materials	106
Table IIIC - Color of Insulation for Identification	106
Table IIIA - Circuit Identification Colors	107
Table IIIB - Circuit Identification Colors	107
Coaxial Cable	
Theory and Application	108
Definitions	109
Table 1 - Inner Conductors	110
Table 2 - Outer Conductors	111
Table 3 - Primary Dielectrics	111
Protective Coverings	112
Table 4 - Jackets	112
Table 5 - Dielectric Properties	112

California

1959 East Cashdan Street, Rancho Dominguez, CA 90220
(310) 609-1811 • (800) 326-0006 • FAX: (310) 609-1862
E-Mail: salesrd@std-wire.com

Arizona

3120 West Thomas Road, Bldg. #801, Phoenix, AZ 85017
(602) 269-2501 • (800) 325-6478 • FAX: (602) 278-7134
E-Mail: salesphx@std-wire.com



Standard Wire & Cable Co.

Manufacturing	115
M17 Cable Descriptions	116 - 124
RG/U Cable Descriptions	125 - 138
Coax Cable Cross-Reference	139 - 140
Attenuation - M17/	141 - 143
Attenuation - RG	144 - 150

HEAT SHRINKABLE PRODUCTS

Heat Shrinkable Products	
Medium/Heavy Wall Tubing	151
Wrap Around Sleeves	151
Cable End Caps	151
Transition Boots	151
Cable Breakout Boots	151
Adhesive and Mastic Tapes	151
Shrink Tubing	151
Ratio Grommets	151
Cable Entry Seals	151
Ratio Tubing	151
Motor Connection Kits	151
Military Heavy Wall Tubing	
Heavy Wall Splice Tubing - Military/Industrial OEM Grade	152
Commercial Heavy Wall Tubing	152
Commercial Medium Wall Tubing	153
Wrap Around Sleeves	
XWSA	153
Military/Industrial Grade End Caps	
Heat Shrinkable End Caps With or Without Sealant & Valves	154
Transition Boot	
Strain Relief & Boots for Harness Systems	155
Right Angle	156
Low-Profile	157
with Lip	158
Ratio Cable Breakout Boot	159
Cable Breakout Boot	160-161
HRSR High-Ratio Sphincter Ring	162-164
Very Flexible Sealing Tape XTPA 080	165
Shrink Tube	
MIL-I-23053/1 (SWCPLD-100)	166
MIL-I-23053/4 (SWCPLSRDW-100)	167
MIL-I-23053/4 (SWCPLDW-100)	168
MIL-I-23053/4 (SWCPLDW-104)	169
MIL-I-23053/5 (SWCPLF-100)	170
MIL-I-23053/5 (SWCPLF-103)	171
MIL-I-23053/5 (SWCPLF-104)	172

California

1959 East Cashdan Street, Rancho Dominguez, CA 90220
 (310) 609-1811 • (800) 326-0006 • FAX: (310) 609-1862
 E-Mail: salesrd@std-wire.com

Arizona

3120 West Thomas Road, Bldg. #801, Phoenix, AZ 85017
 (602) 269-2501 • (800) 325-6478 • FAX: (602) 278-7134
 E-Mail: salesphx@std-wire.com



Standard Wire & Cable Co.

MIL-I-23053/6 (SWCPLSR-100)	173
MIL-I-23053/8 (KYNAR®)	174
MIL-I-23053/13 (VITON®)	175
MIL-I-23053/16 (SWCPLD-101)	176
Technical Data & Conversion Tables	
Recovered Wall Thickness	177
Temperature Conversions	177
Mathematical Formulas	
Circumference of Circle	177
Diameter of Circle	177
Area of Circle	177
Area of Triangle	177
Area of Parallelogram	177
Surface Area of Sphere	177
Volume of Sphere	177
Volume of Prism or Cylinder	177
Volume of Pyramid or Cone	177
Conversion Tables and Equivalencies	
Fractional Inches & Millimeters	178
Decimal Equivalents of Millimeters	178
Area	178
Length	178
Weight	178
Volume	178
Shrink Tube Usage Requirement Table	179 - 180

CABLE HOLDING PRODUCTS

Cable and Hose Clamps	
Adhesive Cable Clamp	181
Adhesive Cable Clip	181
Cable Clip	181
Push Mount Cable Clamp	181
Adhesive Ribbon Cable Clamp	181
Coax Cable Clip	181
Siding Clip	181
Ribbon Cable Clip	181
Snapper Hose Clamp	181
Latch Duct	182
Wiring Duct	182
Spiralwrap	182
Fiber Optic Duct	183
Cable Ties	
Adhesive Cable Tie Mount	183
Mounting Cable Ties	183
Standard Cable Ties	183

California

1959 East Cashdan Street, Rancho Dominguez, CA 90220
 (310) 609-1811 • (800) 326-0006 • FAX: (310) 609-1862
 E-Mail: salesrd@std-wire.com

Arizona

3120 West Thomas Road, Bldg. #801, Phoenix, AZ 85017
 (602) 269-2501 • (800) 325-6478 • FAX: (602) 278-7134
 E-Mail: salesphx@std-wire.com



Standard Wire & Cable Co.

FIBER OPTIC PRODUCTS

Fiber Optic Cable	
Theory and Construction	184
Systems Components	184
Fundamental Principle	185
Fiber Types	185
Cable Construction Considerations	185
Transmission Considerations	186
Simplex & Duplex Cables	
UL Type OFNR	187
UL Type OFNP	187
Distribution Cables	
UL Type OFNR	188
UL Type OFNP	189
Breakout Cables	
UL Type OFNP	190
UL Type OFNR	191
Loose Tube Cables	
UL Type OFNR Outdoor	192 - 193
UL Type OFNR Indoor/Outdoor	194

REFERENCE MATERIAL

Comparison Chart UL Wires & Cables	195 - 199
Comparison Chart	200 - 213
Cable Design Formulas	
Weight of Conductor	214
Weight of Insulation	214
Weight of Jacket	214
Weight of Tape	214
Total Weight of Cabled Conductor	214
Cabling Factors	214
Percent of Shield Coverage	215
Diameter of Shield	215
Property Values (nominal)	215
Twisting Loss	215
Weight of Shield	215
Glossary of Wire & Cable Terminology	216 - 250
Decimal Equivalents	251
Conversion Table of Temperatures	252 - 253
Wire Data - Solid Bare Copper	254 - 255
Wire Data - Stranded Tinned Copper	256 - 258
Trademarks	259
Index of Catalog Numbers	260 - 270
Index	271 - 280
Terms and Conditions	inside back cover

*Standard Wire & Cable Co. assumes no obligation or liability for any information given herein.
All such information herein furnished at buyer's or reader's risk.*

California

1959 East Cashdan Street, Rancho Dominguez, CA 90220
(310) 609-1811 • (800) 326-0006 • FAX: (310) 609-1862
E-Mail: salesrd@std-wire.com

Arizona

3120 West Thomas Road, Bldg. #801, Phoenix, AZ 85017
(602) 269-2501 • (800) 325-6478 • FAX: (602) 278-7134
E-Mail: salesphx@std-wire.com



Standard Wire & Cable Co.

Parallel Speaker Wire

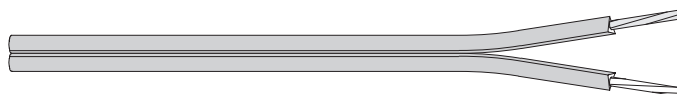

CONDUCTOR: Stranded bare copper except clear which has 1 BC and 1 TC conductor. COLOR: Clear, brown, white*.
 VOLTAGE: 150 V
 UL: CL2

INSULATION: PVC 60° C.

CONSTRUCTION: Parallel.

USES: For use as speaker wire, burglar alarm, and internal wiring in compliance with the National Electric Code, NEC article 725 type CL2.

Catalog No.	No. of Cond.	AWG Size	Stranding	Nominal O.D.		Weight	
				(in)	(mm)	(lbs / 1000 ft)	(kgs / km)
402-2	2	24	7/32	0.060 x 0.122	1.52 x 3.10	6	9
402-8	2	22	7/30	0.065 x 0.140	1.65 x 3.56	8	12
402-14	2	20	10/30	0.075 x 0.150	1.91 x 3.81	11	16
402-16	2	18	16/30	0.085 x 0.165	2.16 x 4.19	15	22
402-29	2	16	26/30	0.095 x 0.185	2.41 x 4.70	21	31
402-34	2	14	41/30	0.110 x 0.220	2.79 x 5.59	31	46

* Custom colors available.

SPT Zip Cord



CONDUCTOR: Stranded bare copper. COLOR: Gray, brown, white, black.

INSULATION: PVC 60° C*. VOLTAGE: 300 V

CONSTRUCTION: Parallel. UL LISTED: Listed.

USES: This duplex cord is often used as audio cable, speaker cable, and in many other applications. This product has good flexibility and is highly versatile for various uses, including lamp cord.

Catalog No.	No. of Cond.	AWG Size	Stranding	SPT	Nominal O.D.		Weight	
					(in)	(mm)	(lbs / 1000 ft)	(kgs / km)
709-2	2	18	41	SPT-1	0.110 x 0.207	2.79 x 5.26	21	31
709-7	2	18	41	SPT-2	0.142 x 0.265	3.61 x 6.73	25	37
709-14	2	16	65	SPT-2	0.155 x 0.295	3.94 x 7.49	38	57

* Also available in 105° C.

California

1959 East Cashdan Street, Rancho Dominguez, CA 90220
 (310) 609-1811 • (800) 326-0006 • FAX: (310) 609-1862
 E-Mail: salesrd@std-wire.com

Arizona

3120 West Thomas Road, Bldg. #801, Phoenix, AZ 85017
 (602) 269-2501 • (800) 325-6478 • FAX: (602) 278-7134
 E-Mail: salesphx@std-wire.com



Standard Wire & Cable Co.

Alarm and Security Cables Burglar Alarm



CONDUCTOR: Solid bare copper. COLOR: Beige, brown, gray, white*.
 INSULATION: PVC VOLTAGE: 300 V / 150 V
 CONSTRUCTION: Parallel conductors. UL: CM / CL2 / CL3 (R)
 JACKET: PVC

USES: For use as burglar alarm wire and as telephone station wire. Good for surface installation, can be stapled to various surfaces in factories, commercial buildings, and homes in compliance with the National Electric Code, NEC article 725 type CL3 or NEC article 800 type CM, as applicable.

Catalog No.	No.** of Cond.	AWG Size	Jacket Thickness		Nominal O. D.		Color Code	Put Up (ft)	Weight	
			(in)	(mm)	(in)	(mm)			(lbs / 1000 ft)	(kgs / km)
400-4A	2	22	0.017	0.432	0.120	3.05	Red, green	1,000	9	13
400-8A	4	22	0.017	0.432	0.145	3.68	Red, green, yellow, black	1,000	15	22

Alarm and Security Cables Unshielded Multi-Conductor



CONDUCTOR: Solid bare copper. COLOR: Gray*.
 INSULATION: PVC VOLTAGE: 300 V / 150 V
 CONSTRUCTION: Unshielded, cabled. UL: CM / CL2 / CL3 (R)
 JACKET: PVC

USES: Public address systems, burglar alarm systems, unbalanced intercom systems, interconnecting cables, remote control circuits, and low voltage relay control systems in compliance with the National Electric Code, NEC article 725 type CL3 or NEC article 800 type CM, as applicable.

Catalog No.	No.** of Cond.	AWG Size	Insulation Thickness		Jacket Thickness		Nominal O. D.		Color Code	Put Up (ft)	Weight	
			(in)	(mm)	(in)	(mm)	(in)	(mm)			(lbs / 1000 ft)	(kgs / km)
1326-13BCA	6	22	0.010	0.254	0.020	0.508	0.180	4.57	Chart 1 Pg. 33	1,000	25	37
1326-14BCA	8	22	0.010	0.254	0.020	0.508	0.203	5.16	Chart 1 Pg. 33	1,000	30	45
1326-16BCA	10	22	0.010	0.254	0.020	0.508	0.224	5.69	Chart 1 Pg. 33	1,000	40	60
1326-17BCA	12	22	0.010	0.254	0.020	0.508	0.235	5.97	Chart 1 Pg. 33	1,000	46	68

* Custom jacket colors available.

** Consult Standard Wire & Cable Co.'s sales department for conductor counts not listed.

California

1959 East Cashdan Street, Rancho Dominguez, CA 90220
 (310) 609-1811 • (800) 326-0006 • FAX: (310) 609-1862
 E-Mail: salesrd@std-wire.com

Arizona

3120 West Thomas Road, Bldg. #801, Phoenix, AZ 85017
 (602) 269-2501 • (800) 325-6478 • FAX: (602) 278-7134
 E-Mail: salesphx@std-wire.com



Standard Wire & Cable Co.

Alarm and Security Cables Unshielded Multi-Conductor



CONDUCTOR: Stranded bare copper.
 INSULATION: PVC
 CONSTRUCTION: Unshielded, cabled.
 JACKET: PVC

COLOR: Gray*.
 VOLTAGE: 300 V / 150 V
 UL: CM / CL2 / CL3 (R)

USES: Public address systems, burglar alarm systems, unbalanced intercom systems, interconnecting cables, remote control circuits, instrumentation, and low voltage relay control systems in compliance with the National Electric Code, NEC article 725 type CL3 or NEC article 800 type CM, as applicable.

Catalog No.	No.** of Cond.	AWG Size	Stranding	Insulation Thickness		Jacket Thickness		Nominal O.D.		Color Code	Put Up (ft)	Weight	
				(in)	(mm)	(in)	(mm)	(in)	(mm)			(lbs / 1000 ft)	(kgs / km)
400-4BC	2	22	7/30	0.008	0.203	0.020	0.508	0.130	3.30	Chart 1 Pg. 33	1,000	12	18
400-8BC	4	22	7/30	0.008	0.203	0.020	0.508	0.160	4.06	Chart 1 Pg. 33	1,000	19	28
1326-3BC	5	22	7/30	0.008	0.203	0.020	0.508	0.170	4.32	Chart 1 Pg. 33	1,000	22	33
1326-13BC	6	22	7/30	0.008	0.203	0.020	0.508	0.175	4.45	Chart 1 Pg. 33	1,000	27	40
1326-14BC	8	22	7/30	0.008	0.203	0.020	0.508	0.195	4.95	Chart 1 Pg. 33	1,000	34	51
1326-16BC	10	22	7/30	0.008	0.203	0.020	0.508	0.210	5.33	Chart 1 Pg. 33	1,000	41	61
1326-17BC	12	22	7/30	0.008	0.203	0.020	0.508	0.230	5.84	Chart 1 Pg. 33	1,000	48	71
400-9BC	2	20	10/30	0.010	0.254	0.020	0.508	0.162	4.11	Chart 1 Pg. 33	1,000	16	24
400-16BC	2	18	16/30	0.010	0.254	0.020	0.508	0.182	4.62	Chart 1 Pg. 33	1,000	21	31
400-20BC	4	18	16/30	0.010	0.254	0.020	0.508	0.210	5.33	Chart 1 Pg. 33	1,000	36	54

** Consult Standard Wire & Cable Co.'s sales department for conductor counts not listed.

Alarm and Security Cables Unshielded Multi-Conductor



CONDUCTOR: Stranded tinned copper.
 INSULATION: PVC
 CONSTRUCTION: Unshielded, cabled.
 JACKET: PVC

COLOR: Gray*.
 VOLTAGE: 300 V / 150 V
 UL: CM / CL2 / CL3 (R)

USES: Public address systems, burglar alarm systems, unbalanced intercom systems, interconnecting cables, remote control circuits, instrumentation, and low voltage relay control systems in compliance with the National Electric Code, NEC article 725 type CL3 or NEC article 800 type CM, as applicable.

* Custom jacket colors available.

California

1959 East Cashdan Street, Rancho Dominguez, CA 90220
 (310) 609-1811 • (800) 326-0006 • FAX: (310) 609-1862
 E-Mail: salesrd@std-wire.com

Arizona

3120 West Thomas Road, Bldg. #801, Phoenix, AZ 85017
 (602) 269-2501 • (800) 325-6478 • FAX: (602) 278-7134
 E-Mail: salesphx@std-wire.com



Standard Wire & Cable Co.

Alarm and Security Cables (cont.) Unshielded Multi-Conductor

Catalog No.	No.** of Cond.	AWG Size	Stranding	Insulation Thickness		Jacket Thickness		Nominal O. D.		Color Code	Put Up (ft)	Weight	
				(in)	(mm)	(in)	(mm)	(in)	(mm)			(lbs / 1000 ft)	(kgs / km)
400-4	2	22	7/30	0.010	0.254	0.020	0.508	0.146	3.71	Chart 1 Pg. 33	1,000	12	18
400-5	3	22	7/30	0.010	0.254	0.020	0.508	0.154	3.91	Chart 1 Pg. 33	1,000	15	22
400-8	4	22	7/30	0.010	0.254	0.020	0.508	0.167	4.24	Chart 1 Pg. 33	1,000	19	28
1326-3	5	22	7/30	0.010	0.254	0.020	0.508	0.180	4.57	Chart 1 Pg. 33	1,000	22	33
1326-13	6	22	7/30	0.010	0.254	0.020	0.508	0.195	4.95	Chart 1 Pg. 33	1,000	27	40
1326-14	8	22	7/30	0.010	0.254	0.020	0.508	0.225	5.72	Chart 1 Pg. 33	1,000	34	51
1326-16	10	22	7/30	0.010	0.254	0.020	0.508	0.245	6.22	Chart 1 Pg. 33	1,000	41	61
1326-17	12	22	7/30	0.010	0.254	0.020	0.508	0.252	6.40	Chart 1 Pg. 33	1,000	48	71
1326-18	15	22	7/30	0.010	0.254	0.020	0.508	0.279	7.09	Chart 2 Pg. 33	1,000	58	86
1326-20	20	22	7/30	0.010	0.254	0.020	0.508	0.308	7.82	Chart 2 Pg. 33	1,000	74	110
1326-25	25	22	7/30	0.010	0.254	0.025	0.635	0.354	8.99	Chart 2 Pg. 33	1,000	93	138
400-9	2	20	10/30	0.010	0.254	0.020	0.508	0.162	4.11	Chart 1 Pg. 33	1,000	17	25
400-10	3	20	10/30	0.010	0.254	0.020	0.508	0.171	4.34	Chart 1 Pg. 33	1,000	23	34
400-11	4	20	10/30	0.010	0.254	0.020	0.508	0.186	4.72	Chart 1 Pg. 33	1,000	26	39
400-16	2	18	16/30	0.010	0.254	0.020	0.508	0.182	4.62	Chart 1 Pg. 33	1,000	21	31
400-17	3	18	16/30	0.010	0.254	0.020	0.508	0.193	4.90	Chart 1 Pg. 33	1,000	28	42
400-20	4	18	16/30	0.010	0.254	0.020	0.508	0.210	5.33	Chart 1 Pg. 33	1,000	36	54
1327-5	5	18	16/30	0.010	0.254	0.020	0.508	0.229	5.82	Chart 1 Pg. 33	1,000	44	65
1327-6	6	18	16/30	0.010	0.254	0.020	0.508	0.239	6.07	Chart 1 Pg. 33	1,000	51	76
1327-7	7	18	16/30	0.010	0.254	0.020	0.508	0.249	6.32	Chart 1 Pg. 33	1,000	59	88
1327-8	8	18	16/30	0.010	0.254	0.025	0.635	0.272	6.91	Chart 1 Pg. 33	1,000	68	101
1327-9	9	18	16/30	0.010	0.254	0.025	0.635	0.295	7.49	Chart 1 Pg. 33	1,000	76	113
1327-10	10	18	16/30	0.010	0.254	0.025	0.635	0.305	7.75	Chart 1 Pg. 33	1,000	85	126
1327-12	12	18	16/30	0.010	0.254	0.025	0.635	0.332	8.43	Chart 1 Pg. 33	1,000	98	146
1327-15	15	18	16/30	0.010	0.254	0.030	0.762	0.379	9.63	Chart 2 Pg. 33	1,000	124	185
1327-19	19	18	16/30	0.010	0.254	0.030	0.762	0.398	10.1	Chart 2 Pg. 33	1,000	153	228
1327-25	25	18	16/30	0.010	0.254	0.030	0.762	0.475	12.1	Chart 2 Pg. 33	1,000	198	295
400-25	2	16	26/30	0.015	0.381	0.020	0.508	0.225	5.72	Chart 1 Pg. 33	1,000	30	45
400-26	3	16	26/30	0.015	0.381	0.020	0.508	0.240	6.10	Chart 1 Pg. 33	1,000	42	62
400-27	4	16	26/30	0.015	0.381	0.025	0.635	0.268	6.81	Chart 1 Pg. 33	1,000	54	80
400-30	2	14	19/27	0.015	0.381	0.020	0.508	0.256	6.50	Chart 1 Pg. 33	1,000	41	61

** Consult Standard Wire & Cable Co.'s sales department for conductor counts not listed.

California

1959 East Cashdan Street, Rancho Dominguez, CA 90220
(310) 609-1811 • (800) 326-0006 • FAX: (310) 609-1862
E-Mail: salesrd@std-wire.com

Arizona

3120 West Thomas Road, Bldg. #801, Phoenix, AZ 85017
(602) 269-2501 • (800) 325-6478 • FAX: (602) 278-7134
E-Mail: salesphx@std-wire.com



Standard Wire & Cable Co.

Intercom Cable Unshielded Solid Pairs



CONDUCTOR: Solid bare copper.
 INSULATION: PVC
 JACKET: PVC
 CONSTRUCTION: Conductors paired and pairs cabled. Pairs have tight twists and are varied to eliminate cross talk.

COLOR: White.
 VOLTAGE: 300 V / 150 V
 UL: CM / CL2 / CL3 (R)

USES: For special intercom cable in compliance with the National Electric Code, NEC article 725 type CL3 or NEC article 800 type CM, as applicable.

Catalog No.	No. of Pairs	AWG Size	Insulation Thickness		Jacket Thickness		Nominal O. D.		Color Code	Put Up (ft)	Weight	
			(in)	(mm)	(in)	(mm)	(in)	(mm)			(lbs / 1000 ft)	(kgs / km)
401-3C	3	22	0.008	0.203	0.020	0.508	0.212	5.38	1st pair red-red/white, 2nd pair black-black/white, 3rd pair orange-orange/white	1,000	27	40

Sound and Intercom Cable Unshielded Stranded Pairs



CONDUCTOR: Stranded tinned copper.
 INSULATION: PVC
 JACKET: PVC
 CONSTRUCTION: Conductors paired and pairs cabled. Insulation has high resistance to crushing and cold flow.

COLOR: Gray.
 VOLTAGE: 300 V / 150 V
 UL: CM / CL2 / CL3 (R)

USES: Used extensively for sound systems and intercom systems in compliance with the National Electric Code, NEC article 725 type CL3 or NEC article 800 type CM, as applicable. Completely color coded cable providing positive pair and conductor identification.

Catalog No.	No. of Pairs	AWG Size	Stranding	Insulation Thickness		Jacket Thickness		Nominal O. D.		Color Code	Put Up (ft)	Weight	
				(in)	(mm)	(in)	(mm)	(in)	(mm)			(lbs / 1000 ft)	(kgs / km)
401-1B	1	22	7/30	0.010	0.254	0.020	0.508	0.188	4.78	Chart 3 Pg. 33	1,000	14	21
401-2B	2	22	7/30	0.010	0.254	0.020	0.508	0.220	5.59	Chart 3 Pg. 33	1,000	22	33
401-3B	3	22	7/30	0.010	0.254	0.020	0.508	0.232	5.89	Chart 3 Pg. 33	1,000	29	43
401-4B	4	22	7/30	0.010	0.254	0.020	0.508	0.254	6.45	Chart 3 Pg. 33	1,000	36	54
401-6B	6	22	7/30	0.010	0.254	0.020	0.508	0.293	7.44	Chart 3 Pg. 33	1,000	50	74
401-9B	9	22	7/30	0.010	0.254	0.020	0.508	0.342	8.69	Chart 3 Pg. 33	1,000	71	106
401-11B	11	22	7/30	0.010	0.254	0.025	0.635	0.380	9.65	Chart 3 Pg. 33	1,000	90	134
401-15B	15	22	7/30	0.010	0.254	0.025	0.635	0.416	10.6	Chart 3 Pg. 33	1,000	114	170
401-19B	19	22	7/30	0.010	0.254	0.025	0.635	0.494	12.5	Chart 3 Pg. 33	1,000	168	250
401-27B	27	22	7/30	0.010	0.254	0.030	0.762	0.545	13.8	Chart 3 Pg. 33	1,000	200	298
401-51B	51	22	7/30	0.010	0.254	0.030	0.762	0.675	17.1	Chart 3 Pg. 33	1,000	355	528
401-2N	2	18	16/30	0.010	0.254	0.020	0.508	0.283	7.19	Chart 3 Pg. 33	1,000	40	60
401-3N	3	18	16/30	0.010	0.254	0.020	0.508	0.300	7.62	Chart 3 Pg. 33	1,000	56	83
401-6N	6	18	16/30	0.010	0.254	0.025	0.635	0.388	9.86	Chart 3 Pg. 33	1,000	104	155
401-9N	9	18	16/30	0.010	0.254	0.025	0.635	0.455	11.6	Chart 3 Pg. 33	1,000	149	222
401-15N	15	18	16/30	0.010	0.254	0.030	0.762	0.559	14.2	Chart 3 Pg. 33	1,000	244	363

California

1959 East Cashdan Street, Rancho Dominguez, CA 90220
 (310) 609-1811 • (800) 326-0006 • FAX: (310) 609-1862
 E-Mail: salesrd@std-wire.com

Arizona

3120 West Thomas Road, Bldg. #801, Phoenix, AZ 85017
 (602) 269-2501 • (800) 325-6478 • FAX: (602) 278-7134
 E-Mail: salesphx@std-wire.com



Standard Wire & Cable Co.

Sound and Intercom Cable Shielded Pairs



CONDUCTOR: Solid and stranded tinned copper. COLOR: Gray.
 INSULATION: PVC VOLTAGE: 300 V / 150 V
 JACKET: PVC UL: CM / CL2 / CL3 (R)
 CONSTRUCTION: Conductors paired and pairs individually shielded with stranded tinned copper drain wire.

USES: Used extensively for sound systems and intercom systems in compliance with the National Electric Code, NEC article 725 type CL3 or NEC article 800 type CM, as applicable. Completely color coded cable providing positive pair and conductor identification.

Catalog No.	No. of Pairs	AWG Size	Stranding	Insulation Thickness		Jacket Thickness		Nominal O. D.		Color Code	Put Up (ft)	Weight	
				(in)	(mm)	(in)	(mm)	(in)	(mm)			(lbs / 1000 ft)	(kgs / km)
405-2A	2	22	7/30	0.010	0.254	0.020	0.508	0.210	5.33	Chart 3 Pg. 33	1,000	21	31
405-3A	3	22	7/30	0.010	0.254	0.020	0.508	0.228	5.79	Chart 3 Pg. 33	1,000	28	42
405-6A	6	22	7/30	0.010	0.254	0.020	0.508	0.289	7.34	Chart 3 Pg. 33	1,000	50	74
405-9A	9	22	7/30	0.010	0.254	0.020	0.508	0.341	8.66	Chart 3 Pg. 33	1,000	72	107
405-11A	11	22	7/30	0.010	0.254	0.025	0.635	0.380	9.65	Chart 3 Pg. 33	1,000	90	134
405-15A	15	22	7/30	0.010	0.254	0.025	0.635	0.424	10.8	Chart 3 Pg. 33	1,000	116	173
405-19A	19	22	7/30	0.010	0.254	0.025	0.635	0.453	11.5	Chart 3 Pg. 33	1,000	145	216
405-27A	27	22	7/30	0.010	0.254	0.030	0.762	0.544	13.8	Chart 3 Pg. 33	1,000	202	301
405-51A	51	22	7/30	0.010	0.254	0.030	0.762	0.800	20.3	Chart 3 Pg. 33	1,000	400	595
405-2B	2	22	Solid	0.010	0.254	0.020	0.508	0.210	5.33	Chart 3 Pg. 33	1,000	21	31
405-3B	3	22	Solid	0.010	0.254	0.020	0.508	0.228	5.79	Chart 3 Pg. 33	1,000	28	42
405-6B	6	22	Solid	0.010	0.254	0.020	0.508	0.289	7.34	Chart 3 Pg. 33	1,000	50	74
405-9B	9	22	Solid	0.010	0.254	0.020	0.508	0.341	8.66	Chart 3 Pg. 33	1,000	72	107
405-11B	11	22	Solid	0.010	0.254	0.025	0.635	0.380	9.65	Chart 3 Pg. 33	1,000	90	134
405-15B	15	22	Solid	0.010	0.254	0.025	0.635	0.424	10.8	Chart 3 Pg. 33	1,000	116	173
405-19B	19	22	Solid	0.010	0.254	0.025	0.635	0.453	11.5	Chart 3 Pg. 33	1,000	145	216
405-27B	27	22	Solid	0.010	0.254	0.030	0.762	0.544	13.8	Chart 3 Pg. 33	1,000	202	301
405-51B	51	22	Solid	0.010	0.254	0.030	0.762	0.800	20.3	Chart 3 Pg. 33	1,000	400	595
405-3G	3	18	16/30	0.010	0.254	0.020	0.508	0.296	7.52	Chart 3 Pg. 33	1,000	56	83
405-6G	6	18	16/30	0.010	0.254	0.025	0.635	0.380	9.65	Chart 3 Pg. 33	1,000	106	158
405-9G	9	18	16/30	0.010	0.254	0.025	0.635	0.459	11.7	Chart 3 Pg. 33	1,000	160	238
405-15G	15	18	16/30	0.010	0.254	0.030	0.762	0.550	14.0	Chart 3 Pg. 33	1,000	275	409

California

1959 East Cashdan Street, Rancho Dominguez, CA 90220
 (310) 609-1811 • (800) 326-0006 • FAX: (310) 609-1862
 E-Mail: salesrd@std-wire.com

Arizona

3120 West Thomas Road, Bldg. #801, Phoenix, AZ 85017
 (602) 269-2501 • (800) 325-6478 • FAX: (602) 278-7134
 E-Mail: salesphx@std-wire.com



Standard Wire & Cable Co.

Sound and Intercom Cable Unshielded Solid Pairs



CONDUCTOR: Solid tinned copper. COLOR: Gray.
 INSULATION: PVC VOLTAGE: 300 V / 150 V
 JACKET: PVC UL: CM / CL2 / CL3 (R)
 CONSTRUCTION: Conductors paired and pairs cabled.

USES: Used extensively for sound systems and intercom systems in compliance with the National Electric Code, NEC article 725 type CL3 or NEC article 800 type CM, as applicable. Completely color coded cable providing positive pair and conductor identification.

Catalog No.	No. of Pairs	AWG Size	Insulation Thickness		Jacket Thickness		Nominal O. D.		Color Code	Put Up (ft)	Weight	
			(in)	(mm)	(in)	(mm)	(in)	(mm)			(lbs / 1000 ft)	(kgs / km)
401-1	1	22	0.010	0.254	0.020	0.508	0.136	3.45	Chart 3 Pg. 33	1,000	11	16
401-2	2	22	0.010	0.254	0.020	0.508	0.202	5.13	Chart 3 Pg. 33	1,000	20	30
401-3	3	22	0.010	0.254	0.020	0.508	0.213	5.41	Chart 3 Pg. 33	1,000	26	39
401-4	4	22	0.010	0.254	0.020	0.508	0.233	5.92	Chart 3 Pg. 33	1,000	33	49
401-6	6	22	0.010	0.254	0.020	0.508	0.268	6.81	Chart 3 Pg. 33	1,000	45	67
401-9	9	22	0.010	0.254	0.020	0.508	0.312	7.92	Chart 3 Pg. 33	1,000	64	95
401-11	11	22	0.010	0.254	0.020	0.508	0.338	8.59	Chart 3 Pg. 33	1,000	76	113
401-15	15	22	0.010	0.254	0.025	0.635	0.379	9.63	Chart 3 Pg. 33	1,000	102	152
401-19	19	22	0.010	0.254	0.025	0.635	0.405	10.3	Chart 3 Pg. 33	1,000	126	187
401-27	27	22	0.010	0.254	0.030	0.762	0.494	12.5	Chart 3 Pg. 33	1,000	179	266
401-51	51	22	0.010	0.254	0.030	0.762	0.640	16.3	Chart 3 Pg. 33	1,000	345	513

Audio and Data Cable Shielded Pairs



CONDUCTOR: Stranded tinned copper. COLOR: Gray.
 INSULATION: Polypropylene. VOLTAGE: 300 V / 150 V
 JACKET: PVC UL: CM / CL2 / CL3 (R)
 CONSTRUCTION: Pairs twisted on a common axis with reversed shields and common tinned copper drain wire. 100% aluminum polyester foil shield.

USES: Used for audio, data, and instrumentation in compliance with the National Electric Code, NEC article 725 type CL3 or NEC article 800 type CM, as applicable. Completely color coded cable providing positive pair and conductor identification.

Catalog No.	No. of Pairs	AWG Size	Stranding	Insulation Thickness		Jacket Thickness		Nominal O. D.		Color Code	Put Up (ft)	Weight	
				(in)	(mm)	(in)	(mm)	(in)	(mm)			(lbs / 1000 ft)	(kgs / km)
405-2AG	2	22	7/30	0.008	0.203	0.020	0.508	0.175	4.45	1st pair red-black, 2nd pair green-white	1,000	19	28

California

1959 East Cashdan Street, Rancho Dominguez, CA 90220
 (310) 609-1811 • (800) 326-0006 • FAX: (310) 609-1862
 E-Mail: salesrd@std-wire.com

Arizona

3120 West Thomas Road, Bldg. #801, Phoenix, AZ 85017
 (602) 269-2501 • (800) 325-6478 • FAX: (602) 278-7134
 E-Mail: salesphx@std-wire.com



Standard Wire & Cable Co.

Audio and Data Cable Shielded Multi-Conductor



CONDUCTOR: Stranded tinned copper. VOLTAGE: 300 V / 150 V
 INSULATION: PVC COLOR CODE: Red & black shielded,
 JACKET: PVC white & green unshielded.
 COLOR: Gray. UL: CM / CL2 / CL3 (R)

CONSTRUCTION: Two conductors and drain wire under shield, two conductors outside of shield placed in interstices.

USES: Used extensively for sound systems, intercom systems, and instrumentation in compliance with the National Electric Code, NEC article 725 type CL3 or NEC article 800 type CM, as applicable.

Catalog No.	No. of Cond.	AWG Size	Stranding	Insulation Thickness		Jacket Thickness		Nominal O. D.		Put Up (ft)	Weight	
				(in)	(mm)	(in)	(mm)	(in)	(mm)		(lbs / 1000 ft)	(kgs / km)
504-25A	4	22	7/30	0.010	0.254	0.020	0.508	0.132	3.35	1,000	18	27

Audio and Data Cable Shielded Multi-Conductor



CONDUCTOR: Stranded tinned copper. VOLTAGE: 600 V / 300 V / 150 V
 INSULATION: Polyethylene. UL: CM / CL2 / CL3 (R)
 JACKET: PVC UL STYLE: 2106, 600 V
 COLOR: Gray.

CONSTRUCTION: Conductors cabled. Overall shield of 100% aluminum polyester foil with a stranded tinned copper drain wire.

USES: Used extensively for sound systems, instrumentation, and traffic signal in compliance with the National Electric Code, NEC article 725 type CL3 or NEC article 800 type CM, as applicable.

Catalog No.	No. of Cond.	AWG Size	Stranding	Drain Wire AWG	Insulation Thickness		Jacket Thickness		Nominal O. D.		Color Code	Put Up (ft)	Weight	
					(in)	(mm)	(in)	(mm)	(in)	(mm)			(lbs / 1000 ft)	(kgs / km)
504-74AB	2	16	19/29	18	0.031	0.787	0.032	0.813	0.304	7.72	Black, clear	1,000	55	82
504-75AB	3	16	19/29	18	0.031	0.787	0.032	0.813	0.338	8.59	Black, red, clear	1,000	70	104
504-87AB	2	14	19/27	16	0.032	0.813	0.040	1.016	0.340	8.64	Black, clear	1,000	68	101
504-90AB	2	12	19/25	14	0.037	0.940	0.040	1.016	0.400	10.2	Black, clear	1,000	100	149

California

1959 East Cashdan Street, Rancho Dominguez, CA 90220
 (310) 609-1811 • (800) 326-0006 • FAX: (310) 609-1862
 E-Mail: salesrd@std-wire.com

Arizona

3120 West Thomas Road, Bldg. #801, Phoenix, AZ 85017
 (602) 269-2501 • (800) 325-6478 • FAX: (602) 278-7134
 E-Mail: salesphx@std-wire.com



Standard Wire & Cable Co.

Audio and Data Cable Shielded Multi-Conductor



CONDUCTOR: Solid and stranded tinned copper.
INSULATION: PVC

JACKET: PVC
COLOR: Gray*.
VOLTAGE: 300 V / 150 V
UL: CM / CL2 / CL3 (R)

CONSTRUCTION: Conductors cabled. Overall shield of 100% aluminum polyester foil with a stranded tinned copper drain wire.

USES: Used extensively for remote signaling circuits, broadcast systems, sound systems, intercom systems, audio systems, and instrumentation in compliance with the National Electric Code, NEC article 725 type CL3 or NEC article 800 type CM, as applicable.

Catalog No.	No.** of Cond.	AWG Size	Stranding	Drain Wire AWG	Insulation Thickness		Jacket Thickness		Nominal O. D.		Color Code	Put Up (ft)	Weight	
					(in)	(mm)	(in)	(mm)	(in)	(mm)			(lbs / 1000 ft)	(kgs / km)
504-8A	2	24	7/30	24	0.008	0.203	0.020	0.508	0.125	3.18	Chart 1 Pg. 33	1,000	10	15
504-14A	2	22	Solid	22	0.008	0.203	0.020	0.508	0.130	3.30	Chart 1 Pg. 33	1,000	12	18
504-15A	2	22	7/30	22	0.008	0.203	0.020	0.508	0.130	3.30	Chart 1 Pg. 33	1,000	14	21
504-20A	3	22	7/30	22	0.008	0.203	0.020	0.508	0.150	3.81	Chart 1 Pg. 33	1,000	16	24
504-24A	4	22	7/30	22	0.008	0.203	0.020	0.508	0.165	4.19	Chart 1 Pg. 33	1,000	18	27
1326-13A	6	22	7/30	22	0.008	0.203	0.020	0.508	0.190	4.83	Chart 1 Pg. 33	1,000	24	36
1326-14A	8	22	7/30	22	0.008	0.203	0.020	0.508	0.210	5.33	Chart 1 Pg. 33	1,000	29	43
1326-16A	10	22	7/30	22	0.008	0.203	0.020	0.508	0.230	5.84	Chart 1 Pg. 33	1,000	35	52
1326-17A	12	22	7/30	22	0.008	0.203	0.020	0.508	0.250	6.35	Chart 1 Pg. 33	1,000	41	61
504-34A	2	20	10/30	22	0.010	0.254	0.020	0.508	0.150	3.81	Chart 1 Pg. 33	1,000	16	24
504-49A	3	20	10/30	22	0.010	0.254	0.020	0.508	0.160	4.06	Chart 1 Pg. 33	1,000	20	30
504-67A	2	18	16/30	20	0.015	0.381	0.030	0.762	0.175	4.45	Chart 1 Pg. 33	1,000	23	34
504-71A	3	18	16/30	20	0.015	0.381	0.030	0.762	0.190	4.83	Chart 1 Pg. 33	1,000	31	46
504-72A	4	18	16/30	20	0.015	0.381	0.030	0.762	0.200	5.08	Chart 1 Pg. 33	1,000	37	55
1327-6A	6	18	16/30	20	0.015	0.381	0.030	0.762	0.285	7.24	Chart 1 Pg. 33	1,000	54	80
504-74A	2	16	26/30	18	0.015	0.381	0.030	0.762	0.210	5.33	Chart 1 Pg. 33	1,000	34	51

* Custom jacket colors available.

** Consult Standard Wire & Cable Co.'s sales department for conductor counts not listed.

California

1959 East Cashdan Street, Rancho Dominguez, CA 90220
(310) 609-1811 • (800) 326-0006 • FAX: (310) 609-1862
E-Mail: salesrd@std-wire.com

Arizona

3120 West Thomas Road, Bldg. #801, Phoenix, AZ 85017
(602) 269-2501 • (800) 325-6478 • FAX: (602) 278-7134
E-Mail: salesphx@std-wire.com



Standard Wire & Cable Co.

Fire Alarm Cable Parallel



CONDUCTOR: Solid bare copper. COLOR: Red, white* - marking surface print.
 INSULATION: PVC VOLTAGE: 300 V
 CONSTRUCTION: Flat parallel. UL: FPL (R)

USES: Used extensively for low energy communication and safety control wiring in compliance with the National Fire Protective Association and the National Electric Code, NEC article 760 type FPL.

Catalog No.	No. of Cond.	AWG Size	Insulation Thickness		Nominal O. D.		Put Up (ft)	Weight	
			(in)	(mm)	(in)	(mm)		(lbs / 1000 ft)	(kgs / km)
402-23	2	18	0.031	0.787	0.110 x 0.213	2.79 x 5.41	1,000	20	30
402-32	2	16	0.031	0.787	0.115 x 0.230	2.92 x 5.84	1,000	26	39
402-35	2	14	0.031	0.787	0.128 x 0.256	3.25 x 6.50	1,000	36	54

* Custom colors available.

Fire Alarm Cable Shielded Multi-Conductor



CONDUCTOR: Solid bare copper. COLOR: Red*.
 INSULATION: PVC VOLTAGE: 300 V
 JACKET: PVC UL: FPL (R)

CONSTRUCTION: Conductors cabled. Overall shield of 100% aluminum polyester foil with a stranded tinned copper drain wire.

USES: Used extensively for low energy communication and safety control wiring in compliance with the National Fire Protective Association and the National Electric Code, NEC article 760 type FPL.

Catalog No.	No.** of Cond.	AWG Size	Insulation Thickness		Jacket Thickness		Nominal O. D.		Color Code	Put Up (ft)	Weight	
			(in)	(mm)	(in)	(mm)	(in)	(mm)			(lbs / 1000 ft)	(kgs / km)
504-67FA	2	18	0.010	0.254	0.025	0.635	0.171	4.34	Chart 5 Pg. 33	1,000	22	33
504-72FA	4	18	0.010	0.254	0.025	0.635	0.196	4.98	Chart 5 Pg. 33	1,000	35	52
504-74FA	2	16	0.010	0.254	0.025	0.635	0.198	5.03	Chart 5 Pg. 33	1,000	29	43
504-75FA	4	16	0.010	0.254	0.025	0.635	0.222	5.64	Chart 5 Pg. 33	1,000	50	74
504-87FA	2	14	0.015	0.381	0.025	0.635	0.245	6.22	Chart 5 Pg. 33	1,000	46	68
504-89FA	4	14	0.015	0.381	0.025	0.635	0.285	7.24	Chart 5 Pg. 33	1,000	55	82
504-90FA	2	12	0.015	0.381	0.025	0.635	0.275	6.99	Chart 5 Pg. 33	1,000	58	86
504-94FA	4	12	0.015	0.381	0.025	0.635	0.325	8.26	Chart 5 Pg. 33	1,000	107	159

* Custom jacket colors available.

** Consult Standard Wire & Cable Co.'s sales department for conductor counts not listed.

California

1959 East Cashdan Street, Rancho Dominguez, CA 90220
 (310) 609-1811 • (800) 326-0006 • FAX: (310) 609-1862
 E-Mail: salesrd@std-wire.com

Arizona

3120 West Thomas Road, Bldg. #801, Phoenix, AZ 85017
 (602) 269-2501 • (800) 325-6478 • FAX: (602) 278-7134
 E-Mail: salesphx@std-wire.com



Standard Wire & Cable Co.

Fire Alarm Cable Unshielded Multi-Conductor



CONDUCTOR: Solid bare copper.
 INSULATION: PVC
 JACKET: PVC

COLOR: Red*.
 VOLTAGE: 300 V
 UL: FPL (R)

CONSTRUCTION: Conductors cabled.

USES: Used extensively for low energy communication and safety control wiring in compliance with the National Fire Protective Association and the National Electric Code, NEC article 760 type FPL.

Catalog No.	No.** of Cond.	AWG Size	Insulation Thickness		Jacket Thickness		Nominal O. D.		Color Code	Put Up (ft)	Weight	
			(in)	(mm)	(in)	(mm)	(in)	(mm)			(lbs / 1000 ft)	(kgs / km)
400-8FA	4	22	0.010	0.254	0.025	0.635	0.159	4.04	Chart 5 Pg. 33	1,000	19	28
1326-12FA	6	22	0.010	0.254	0.025	0.635	0.185	4.70	Chart 5 Pg. 33	1,000	25	37
1326-16FA	10	22	0.010	0.254	0.025	0.635	0.229	5.82	Chart 5 Pg. 33	1,000	38	57
400-16FA	2	18	0.010	0.254	0.025	0.635	0.171	4.34	Chart 5 Pg. 33	1,000	20	30
400-20FA	4	18	0.010	0.254	0.025	0.635	0.196	4.98	Chart 5 Pg. 33	1,000	33	49
1327-12FA	6	18	0.010	0.254	0.025	0.635	0.230	5.84	Chart 5 Pg. 33	1,000	48	71
1327-14FA	8	18	0.010	0.254	0.025	0.635	0.266	6.76	Chart 5 Pg. 33	1,000	62	92
400-25FA	2	16	0.010	0.254	0.025	0.635	0.182	4.62	Chart 5 Pg. 33	1,000	24	36
400-27FA	4	16	0.010	0.254	0.025	0.635	0.212	5.38	Chart 5 Pg. 33	1,000	43	64
400-30FA	2	14	0.015	0.381	0.025	0.635	0.208	5.28	Chart 5 Pg. 33	1,000	35	52
400-34FA	4	14	0.015	0.381	0.025	0.635	0.350	8.89	Chart 5 Pg. 33	1,000	75	112
400-38FA	2	12	0.015	0.381	0.025	0.635	0.320	8.13	Chart 5 Pg. 33	1,000	57	85

* Custom jacket colors available.

** Consult Standard Wire & Cable Co.'s sales department for conductor counts not listed.

California

1959 East Cashdan Street, Rancho Dominguez, CA 90220
 (310) 609-1811 • (800) 326-0006 • FAX: (310) 609-1862
 E-Mail: salesrd@std-wire.com

Arizona

3120 West Thomas Road, Bldg. #801, Phoenix, AZ 85017
 (602) 269-2501 • (800) 325-6478 • FAX: (602) 278-7134
 E-Mail: salesphx@std-wire.com



Standard Wire & Cable Co.

Inside Telephone Multi-Pair Category 1 Unshielded Pairs



CONDUCTOR: Solid bare copper. **COLOR:** Gray, beige.*
INSULATION: PVC **VOLTAGE:** 300 V
JACKET: PVC **UL:** CM or CMR

CONSTRUCTION: Twisted pairs, varying lays to minimize cross talk, each pair is banded with insulation color mating conductor, nylon rip cord, cabled. Mutual capacitance 36.0 pF/ft. maximum, DC resistance 28.6 ohms/1,000 ft. maximum.

USES: Inside wiring runs and connector cable assemblies for multi-line installations such as PBX systems in compliance with the National Electric Code, NEC article 800 type CM or CMR. Completely color coded cable providing positive pair and conductor identification. Voice and low-speed data applications.

Catalog No.	No. of Pairs	AWG Size	Insulation Thickness		Jacket Thickness		Nominal O. D.		Color Code	Put Up (ft)	Weight	
			(in)	(mm)	(in)	(mm)	(in)	(mm)			(lbs / 1000 ft)	(kgs / km)
401-2F	2	24	0.006	0.152	0.015	0.381	0.120	3.05	Chart 4 Pg. 33	1,000	8	12
401-3F	3	24	0.006	0.152	0.015	0.381	0.140	3.56	Chart 4 Pg. 33	1,000	13	19
401-4F	4	24	0.006	0.152	0.015	0.381	0.160	4.06	Chart 4 Pg. 33	1,000	16	24
401-6F	6	24	0.006	0.152	0.015	0.381	0.180	4.57	Chart 4 Pg. 33	1,000	22	33
401-12F	12	24	0.006	0.152	0.015	0.381	0.240	6.10	Chart 4 Pg. 33	1,000	41	61
401-25F	25	24	0.006	0.152	0.015	0.381	0.330	8.38	Chart 4 Pg. 33	1,000	81	121
401-50F	50	24	0.006	0.152	0.020	0.508	0.470	11.9	Chart 4 Pg. 33	1,000	156	232
401-75F	75	24	0.006	0.152	0.020	0.508	0.570	14.5	Chart 4 Pg. 33	1,000	234	348
401-100F	100	24	0.006	0.152	0.020	0.508	0.650	16.5	Chart 4 Pg. 33	1,000	307	457

* Custom jacket colors available.

California

1959 East Cashdan Street, Rancho Dominguez, CA 90220
 (310) 609-1811 • (800) 326-0006 • FAX: (310) 609-1862
 E-Mail: salesrd@std-wire.com

Arizona

3120 West Thomas Road, Bldg. #801, Phoenix, AZ 85017
 (602) 269-2501 • (800) 325-6478 • FAX: (602) 278-7134
 E-Mail: salesphx@std-wire.com



Standard Wire & Cable Co.

Inside Telephone Multi-Pair Category 1 Overall Shield



CONDUCTOR: Solid bare copper.
 INSULATION: PVC
 JACKET: PVC

COLOR: Gray, beige.*
 VOLTAGE: 300 V
 UL: CM or CMR

CONSTRUCTION: Twisted pairs, varying lays to minimize cross talk, each pair is banded with insulation color mating conductor, nylon rip cord, cabled. Overall shield of 100% aluminum polyester foil with solid tinned copper drain wire. Mutual capacitance 36.0 pF/ft. maximum, DC resistance 28.6 ohms/1,000 ft. maximum.

USES: Inside wiring runs and connector cable assemblies for multi-line installations such as PBX systems in compliance with the National Electric Code, NEC article 800 type CM or CMR. Completely color coded cable providing positive pair and conductor identification. Voice and low-speed data applications.

Catalog No.	No. of Pairs	AWG Size	Insulation Thickness		Jacket Thickness		Nominal O. D.		Color Code	Put Up (ft)	Weight	
			(in)	(mm)	(in)	(mm)	(in)	(mm)			(lbs / 1000 ft)	(kgs / km)
401-3FS	3	24	0.006	0.152	0.015	0.381	0.140	3.56	Chart 4 Pg. 33	1,000	14	21
401-4FS	4	24	0.006	0.152	0.015	0.381	0.160	4.06	Chart 4 Pg. 33	1,000	18	27
401-6FS	6	24	0.006	0.152	0.015	0.381	0.180	4.57	Chart 4 Pg. 33	1,000	24	36
401-12FS	12	24	0.006	0.152	0.015	0.381	0.240	6.10	Chart 4 Pg. 33	1,000	42	62
401-25FS	25	24	0.006	0.152	0.015	0.381	0.330	8.38	Chart 4 Pg. 33	1,000	82	122

* Custom jacket colors available.

California

1959 East Cashdan Street, Rancho Dominguez, CA 90220
 (310) 609-1811 • (800) 326-0006 • FAX: (310) 609-1862
 E-Mail: salesrd@std-wire.com

Arizona

3120 West Thomas Road, Bldg. #801, Phoenix, AZ 85017
 (602) 269-2501 • (800) 325-6478 • FAX: (602) 278-7134
 E-Mail: salesphx@std-wire.com



Standard Wire & Cable Co.

Inside Telephone Multi-Pair Category 3 Unshielded Pairs



CONDUCTOR: Solid bare copper. COLOR: Gray, beige*.
 INSULATION: PVC VOLTAGE: 300 V
 JACKET: PVC UL: CM or CMR

CONSTRUCTION: Twisted pairs, varying lays to minimize cross talk, each pair is banded with insulation color mating conductor, nylon rip cord, cabled. Category 3 cables are produced to the requirements of EIA/TIA-568, Commercial Building Telecommunications Wiring Standard for horizontal cabling. Swept tested up to 16 MHz.

USES: Applications supported include IEEE 802.3 10-Base-T, Ethernet on UTP, and other applications up to and including 10 Mbps data transmission rates. This is the lowest performance level cable recommended by EIA/TIA-568 for voice or data use.

ELECTRICAL SPECIFICATIONS:

Requirement	Test Frequency	Nominal	Specification
Mutual Capacitance:	1 KHz	17.0 pF / ft	20.0 pF / ft max.
Conductor DCR:	DC	26.7 ohms / 1,000 ft	28.6 ohms / 1,000 ft max.
Characteristic Impedance:	1-16 MHz	100 ohms	100 ± 15 ohms

Frequency	Attenuation Max.		Near End Cross Talk Max.		Return Loss Max. (db)
	(db / 1000 ft)	(db / 100 m)	(db / 1000 ft)	(db / 100 m)	
0.772	6.8	2.2	66	22	12
1.0	7.8	2.6	62	20	12
4.0	17	5.6	49	16	12
8.0	26	8.5	43	14	12
10.0	30	9.8	40	13	12
16.0	40	13	35	11	10

Catalog No.	No. of Pairs	AWG Size	Insulation Thickness		Jacket Thickness		Nominal O. D.		Color Code	Put Up (ft)	Weight	
			(in)	(mm)	(in)	(mm)	(in)	(mm)			(lbs / 1000 ft)	(kgs / km)
401-2F-C3	2	24	0.009	0.229	0.018	0.457	0.155	3.94	Chart 4 Pg. 33	1,000	12	18
401-3F-C3	3	24	0.009	0.229	0.018	0.457	0.165	4.19	Chart 4 Pg. 33	1,000	16	24
401-4F-C3	4	24	0.009	0.229	0.018	0.457	0.180	4.57	Chart 4 Pg. 33	1,000	20	30
401-6F-C3	6	24	0.009	0.229	0.018	0.457	0.230	5.84	Chart 4 Pg. 33	1,000	31	46
401-8F-C3	8	24	0.009	0.229	0.018	0.457	0.250	6.35	Chart 4 Pg. 33	1,000	40	60
401-12F-C3	12	24	0.009	0.229	0.018	0.457	0.310	7.87	Chart 4 Pg. 33	1,000	66	98
401-25F-C3	25	24	0.009	0.229	0.018	0.457	0.425	10.8	Chart 4 Pg. 33	1,000	110	164
401-100F-C3	100	24	0.009	0.229	0.018	0.457	0.838	21.3	Chart 4 Pg. 33	1,000	412	613

* Custom jacket colors available.

California

1959 East Cashdan Street, Rancho Dominguez, CA 90220
 (310) 609-1811 • (800) 326-0006 • FAX: (310) 609-1862
 E-Mail: salesrd@std-wire.com

Arizona

3120 West Thomas Road, Bldg. #801, Phoenix, AZ 85017
 (602) 269-2501 • (800) 325-6478 • FAX: (602) 278-7134
 E-Mail: salesphx@std-wire.com



Standard Wire & Cable Co.

Inside Telephone Multi-Pair Category 4 Unshielded Pairs



CONDUCTOR: Solid bare copper.
 INSULATION: Polyolefin.
 JACKET: PVC

COLOR: Gray, beige*.
 VOLTAGE: 300 V
 UL: CM or CMR

CONSTRUCTION: Twisted pairs, varying lays to minimize cross talk, each pair is banded with insulation color mating conductor, nylon rip cord, cabled. These cables meet the requirements of EIA/TIA TSB-36 Category 4, and NEMA WC63 Low Loss specifications. Swept tested up to 20 MHz.

USES: Applications supported include IEEE 802.5 16 Mbps UTP, 16 Mbps Token Ring, and other high-speed LAN applications up to and including 20 Mbps data transmission rates. This is the lowest performance level considered as Data Grade UTP.

ELECTRICAL SPECIFICATIONS:

Requirement	Test Frequency	Nominal	Specification
Mutual Capacitance:	1 KHz	15.2 pF / ft	17.0 pF / ft max.
Conductor DCR:	DC	26.7 ohms / 1,000 ft	28.6 ohms / 1,000 ft max.
Characteristic Impedance:	1-20 MHz	100 ohms	100 ± 15 ohms

Frequency	Attenuation Max.		Near End Cross Talk Max.		Return Loss Max. (db)
	(db / 1000 ft)	(db / 100 m)	(db / 1000 ft)	(db / 100 m)	
0.772	5.7	1.9	58	19	21
1.0	6.5	2.1	56	18	21
4.0	13	4.3	47	15	21
8.0	19	6.2	42	14	21
10.0	22	7.2	41	13	21
16.0	27	8.9	38	12	19
20.0	31	10	36	12	18

Catalog No.	No. of Pairs	AWG Size	Insulation Thickness		Jacket Thickness		Nominal O. D.		Color Code	Put Up (ft)	Weight	
			(in)	(mm)	(in)	(mm)	(in)	(mm)			(lbs / 1000 ft)	(kgs / km)
401-2F-C4	2	24	0.007	0.178	0.018	0.457	0.180	4.57	Chart 4 Pg. 33	1,000	17	25
401-3F-C4	3	24	0.007	0.178	0.018	0.457	0.190	4.83	Chart 4 Pg. 33	1,000	20	30
401-4F-C4	4	24	0.007	0.178	0.018	0.457	0.205	5.21	Chart 4 Pg. 33	1,000	22	33
401-6F-C4	6	24	0.007	0.178	0.018	0.457	0.238	6.05	Chart 4 Pg. 33	1,000	30	45
401-8F-C4	8	24	0.007	0.178	0.018	0.457	0.251	6.38	Chart 4 Pg. 33	1,000	37	55
401-12F-C4	12	24	0.007	0.178	0.018	0.457	0.299	7.59	Chart 4 Pg. 33	1,000	51	76
401-25F-C4	25	24	0.007	0.178	0.018	0.457	0.423	10.7	Chart 4 Pg. 33	1,000	108	161

* Custom jacket colors available.

California

1959 East Cashdan Street, Rancho Dominguez, CA 90220
 (310) 609-1811 • (800) 326-0006 • FAX: (310) 609-1862
 E-Mail: salesrd@std-wire.com

Arizona

3120 West Thomas Road, Bldg. #801, Phoenix, AZ 85017
 (602) 269-2501 • (800) 325-6478 • FAX: (602) 278-7134
 E-Mail: salesphx@std-wire.com



Standard Wire & Cable Co.

Inside Telephone Multi-Pair Category 5 Unshielded Pairs



CONDUCTOR: Solid bare copper. COLOR: Gray, beige*.
 INSULATION: Polyolefin. VOLTAGE: 300 V
 JACKET: PVC UL: CM or CMR
 CONSTRUCTION: Twisted pairs, varying lays to minimize cross talk, each pair is banded with insulation color mating conductor, nylon rip cord, cabled. These cables meet the requirements of EIA/TIA TSB-36 Category 5, and NEMA WC63 Extended Frequency specifications. Swept tested up to 100 MHz.

USES: Applications supported include ANSI X3T9.5 100 Mbps TP-PMD standard under development, 100 Mbps TPDDI or CDDI (FDDI on UTP), as well as 16 Mbps Token Ring, and other high-speed LAN applications up to and including 100 Mbps data transmission rates. This is the highest level available UTP or Data Grade UTP.

ELECTRICAL SPECIFICATIONS:

Requirement	Test Frequency	Nominal	Specification
Mutual Capacitance:	1 KHz	14.5 pF / ft	10.0 pF / ft max.
Conductor DCR:	DC	26.7 ohms / 1,000 ft	28.6 ohms / 1,000 ft max.
Characteristic Impedance:	1-100 MHz	100 ohms	100 ± 15 ohms

Frequency	Attenuation Max.		Near End Cross Talk Max.		Return Loss Max. (db)
	(db / 1000 ft)	(db / 100 m)	(db / 1000 ft)	(db / 100 m)	
0.772	5.5	1.8	64	21	23
1.0	6.3	2.1	62	20	23
4.0	13	4.3	53	17	23
8.0	18	5.9	48	16	23
10.0	20	6.6	47	15	23
16.0	25	8.2	44	14	23
20.0	28	9.2	42	14	23
25.0	32	10	41	13	22
31.25	36	12	40	13	21
62.5	52	17	35	11	8
100.0	67	22	32	10	16

Catalog No.	No. of Pairs	AWG Size	Insulation Thickness		Jacket Thickness		Nominal O. D.		Color Code	Put Up (ft)	Weight	
			(in)	(mm)	(in)	(mm)	(in)	(mm)			(lbs / 1000 ft)	(kgs / km)
401-2F-C5	2	24	0.008	0.203	0.025	0.635	0.181	4.60	Chart 4 Pg. 33	1,000	15	22
401-3F-C5	3	24	0.008	0.203	0.025	0.635	0.190	4.83	Chart 4 Pg. 33	1,000	18	27
401-4F-C5	4	24	0.008	0.203	0.025	0.635	0.205	5.21	Chart 4 Pg. 33	1,000	22	33
401-6F-C5	6	24	0.008	0.203	0.025	0.635	0.233	5.92	Chart 4 Pg. 33	1,000	30	45
401-8F-C5	8	24	0.008	0.203	0.025	0.635	0.253	6.43	Chart 4 Pg. 33	1,000	36	54
401-12F-C5	12	24	0.008	0.203	0.025	0.635	0.304	7.72	Chart 4 Pg. 33	1,000	52	77
401-25F-C5	25	24	0.008	0.203	0.035	0.889	0.427	10.8	Chart 4 Pg. 33	1,000	107	159

* Custom jacket colors available.

California

1959 East Cashdan Street, Rancho Dominguez, CA 90220
 (310) 609-1811 • (800) 326-0006 • FAX: (310) 609-1862
 E-Mail: salesrd@std-wire.com

Arizona

3120 West Thomas Road, Bldg. #801, Phoenix, AZ 85017
 (602) 269-2501 • (800) 325-6478 • FAX: (602) 278-7134
 E-Mail: salesphx@std-wire.com



Standard Wire & Cable Co.

Inside Telephone Multi-Pair Category 5 Overall Shield

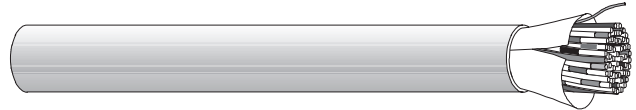

CONDUCTOR: Solid bare copper.

COLOR: Gray, beige.*

INSULATION: Polyolefin.

VOLTAGE: 300 V

JACKET: PVC

UL: CM or CMR

CONSTRUCTION: Twisted pairs, varying lays to minimize cross talk, each pair is banded with insulation color mating conductor, nylon rip cord, cabled. Overall shield of 100% aluminum polyester foil with solid tinned copper drain wire. These cables meet the requirements of EIA/TIA TSB-36 Category 5, and NEMA WC63 Extended Frequency specifications. Swept tested up to 100 MHz.

USES: Applications supported include ANSI X3T9.5 100 Mbps TP-PMD standard under development, 100 Mbps TPDDI or CDDI (FDDI on UTP), as well as 16 Mbps Token Ring, and other high-speed LAN applications up to and including 100 Mbps data transmission rates. This is the highest level available UTP or Data Grade UTP.

ELECTRICAL SPECIFICATIONS:

Requirement	Test Frequency	Nominal	Specification
Mutual Capacitance:	1 KHz	14.5 pF / ft	10.0 pF / ft max.
Conductor DCR:	DC	26.7 ohms / 1,000 ft	28.6 ohms / 1,000 ft max.
Characteristic Impedance:	1-100 MHz	100 ohms	100 ± 15 ohms

Frequency	Attenuation Max.		Near End Cross Talk Max.		Return Loss Max. (db)
	(db / 1000 ft)	(db / 100 m)	(db / 1000 ft)	(db / 100 m)	
0.772	5.5	1.8	64	21	23
1.0	6.3	2.1	62	20	23
4.0	13	4.3	53	17	23
8.0	18	5.9	48	16	23
10.0	20	6.6	47	15	23
16.0	25	8.2	44	14	23
20.0	28	9.2	42	14	23
25.0	32	10	41	13	22
31.25	36	12	40	13	21
62.5	52	17	35	11	8
100.0	67	22	32	10	16

Catalog No.	No. of Pairs	AWG Size	Insulation Thickness		Jacket Thickness		Nominal O. D.		Color Code	Put Up (ft)	Weight	
			(in)	(mm)	(in)	(mm)	(in)	(mm)			(lbs / 1000 ft)	(kgs / km)
401-2FS-C5	2	24	0.011	0.279	0.025	0.635	0.180	4.57	Chart 4 Pg. 33	1,000	16	24
401-3FS-C5	3	24	0.011	0.279	0.025	0.635	0.190	4.83	Chart 4 Pg. 33	1,000	19	28
401-4FS-C5	4	24	0.011	0.279	0.025	0.635	0.220	5.59	Chart 4 Pg. 33	1,000	24	36
401-6FS-C5	6	24	0.011	0.279	0.025	0.635	0.250	6.35	Chart 4 Pg. 33	1,000	32	48
401-8FS-C5	8	24	0.011	0.279	0.025	0.635	0.311	7.90	Chart 4 Pg. 33	1,000	41	61
401-12FS-C5	12	24	0.011	0.279	0.025	0.635	0.320	8.13	Chart 4 Pg. 33	1,000	58	86
401-25FS-C5	25	24	0.011	0.279	0.035	0.889	0.500	12.7	Chart 4 Pg. 33	1,000	114	170

* Custom jacket colors available.

California

1959 East Cashdan Street, Rancho Dominguez, CA 90220
(310) 609-1811 • (800) 326-0006 • FAX: (310) 609-1862
E-Mail: salesrd@std-wire.com

Arizona

3120 West Thomas Road, Bldg. #801, Phoenix, AZ 85017
(602) 269-2501 • (800) 325-6478 • FAX: (602) 278-7134
E-Mail: salesphx@std-wire.com



Standard Wire & Cable Co.

Air Plenum Unshielded Multi-Conductor



CONDUCTOR: Stranded copper. COLOR: White*.
 INSULATION: Teflon® FEP, Halar® ECTFE, JACKET: Teflon® 200° C, ECTFE 150° C, or low smoke PVC. PVDF copolymer 125° C, or low smoke PVC 75° C.
 VOLTAGE: 150 V
 CONSTRUCTION: Conductors cabled. UL: CL2P

USES: For use in air plenums without conduit for audio systems, intercom systems, computer systems, and low energy communication and safety control wiring in compliance with the National Fire Protective Association and the National Electric Code, NEC article 725 type CL2P.

Catalog No.	No.** of Cond.	AWG Size	Insulation Thickness		Jacket Thickness		Nominal O. D.		Color Code	Put Up (ft)	Weight	
			(in)	(mm)	(in)	(mm)	(in)	(mm)			(lbs / 1000 ft)	(kgs / km)
400-4PL	2	22	0.008	0.203	0.020	0.508	0.120	3.05	Chart 1 Pg. 33	1,000	8	12
400-5PL	3	22	0.008	0.203	0.020	0.508	0.145	3.68	Chart 1 Pg. 33	1,000	10	15
400-8PL	4	22	0.008	0.203	0.020	0.508	0.160	4.06	Chart 1 Pg. 33	1,000	12	18
1326-3PL	5	22	0.008	0.203	0.020	0.508	0.165	4.19	Chart 1 Pg. 33	1,000	14	21
1326-13PL	6	22	0.008	0.203	0.020	0.508	0.175	4.45	Chart 1 Pg. 33	1,000	16	24
400-16PL	2	18	0.008	0.203	0.020	0.508	0.150	3.81	Chart 1 Pg. 33	1,000	16	24
400-17PL	3	18	0.008	0.203	0.020	0.508	0.190	4.83	Chart 1 Pg. 33	1,000	21	31
400-20PL	4	18	0.008	0.203	0.020	0.508	0.205	5.21	Chart 1 Pg. 33	1,000	28	42
1327-5PL	5	18	0.008	0.203	0.020	0.508	0.230	5.84	Chart 1 Pg. 33	1,000	32	48
1327-6PL	6	18	0.008	0.203	0.020	0.508	0.240	6.10	Chart 1 Pg. 33	1,000	42	62
1327-7PL	7	18	0.008	0.203	0.020	0.508	0.260	6.60	Chart 1 Pg. 33	1,000	50	74
1327-8PL	8	18	0.008	0.203	0.020	0.508	0.275	6.99	Chart 1 Pg. 33	1,000	60	89
400-25PL	2	16	0.008	0.203	0.020	0.508	0.165	4.19	Chart 1 Pg. 33	1,000	26	39
400-27PL	4	16	0.008	0.203	0.020	0.508	0.230	5.84	Chart 1 Pg. 33	1,000	29	43

* Custom jacket colors available.

** Consult Standard Wire & Cable Co.'s sales department for conductor counts not listed.

Teflon® is a trademark of the DuPont de Nemours Co.

Halar® is a trademark of the Allied Chemical Co.

California

1959 East Cashdan Street, Rancho Dominguez, CA 90220
 (310) 609-1811 • (800) 326-0006 • FAX: (310) 609-1862
 E-Mail: salesrd@std-wire.com

Arizona

3120 West Thomas Road, Bldg. #801, Phoenix, AZ 85017
 (602) 269-2501 • (800) 325-6478 • FAX: (602) 278-7134
 E-Mail: salesphx@std-wire.com



Standard Wire & Cable Co.

Air Plenum Shielded Multi-Conductor



CONDUCTOR: Stranded copper. COLOR: White*.
 INSULATION: Teflon® FEP, Halar® ECTFE, JACKET: Teflon® 200° C, ECTFE 150° C, PVDF copolymer 125° C, or low smoke PVC.
 VOLTAGE: 150 V UL: CL2P

CONSTRUCTION: Conductors cabled. Overall shield of 100% aluminum polyester foil with a stranded tinned copper drain wire.

USES: For use in air plenums without conduit for audio systems, intercom systems, computer systems, and low energy communication and safety control wiring in compliance with the National Fire Protective Association and the National Electric Code, NEC article 725 type CL2P.

Catalog No.	No.** of Cond.	AWG Size	Insulation Thickness		Jacket Thickness		Nominal O. D.		Color Code	Put Up (ft)	Weight	
			(in)	(mm)	(in)	(mm)	(in)	(mm)			(lbs / 1000 ft)	(kgs / km)
504-15APL	2	22	0.008	0.203	0.020	0.508	0.130	3.30	Chart 1 Pg. 33	1,000	13	19
504-20APL	3	22	0.008	0.203	0.020	0.508	0.140	3.56	Chart 1 Pg. 33	1,000	16	24
504-25APL	4	22	0.008	0.203	0.020	0.508	0.150	3.81	Chart 1 Pg. 33	1,000	19	28
1326-3APL	5	22	0.008	0.203	0.020	0.508	0.160	4.06	Chart 1 Pg. 33	1,000	23	34
1326-13APL	6	22	0.008	0.203	0.020	0.508	0.175	4.45	Chart 1 Pg. 33	1,000	26	39
1326-14APL	8	22	0.008	0.203	0.020	0.508	0.200	5.08	Chart 1 Pg. 33	1,000	33	49
1326-16APL	10	22	0.008	0.203	0.020	0.508	0.220	5.59	Chart 1 Pg. 33	1,000	39	58
504-67APL	2	18	0.008	0.203	0.020	0.508	0.170	4.32	Chart 1 Pg. 33	1,000	23	34
504-71APL	3	18	0.008	0.203	0.020	0.508	0.180	4.57	Chart 1 Pg. 33	1,000	28	42
504-72APL	4	18	0.008	0.203	0.020	0.508	0.195	4.95	Chart 1 Pg. 33	1,000	37	55
1327-5APL	5	18	0.008	0.203	0.020	0.508	0.210	5.33	Chart 1 Pg. 33	1,000	44	65
1327-6APL	6	18	0.008	0.203	0.020	0.508	0.230	5.84	Chart 1 Pg. 33	1,000	51	76
1327-7APL	7	18	0.008	0.203	0.020	0.508	0.235	5.97	Chart 1 Pg. 33	1,000	58	86
1327-8APL	8	18	0.008	0.203	0.020	0.508	0.265	6.73	Chart 1 Pg. 33	1,000	65	97
504-74APL	2	16	0.008	0.203	0.020	0.508	0.185	4.70	Chart 1 Pg. 33	1,000	30	45
504-75APL	3	16	0.008	0.203	0.020	0.508	0.195	4.95	Chart 1 Pg. 33	1,000	39	58
504-76APL	4	16	0.008	0.203	0.020	0.508	0.210	5.33	Chart 1 Pg. 33	1,000	49	73

* Custom jacket colors available.

** Consult Standard Wire & Cable Co.'s sales department for conductor counts not listed.

Teflon® is a trademark of the DuPont de Nemours Co.

Halar® is a trademark of the Allied Chemical Co.

California

1959 East Cashdan Street, Rancho Dominguez, CA 90220
 (310) 609-1811 • (800) 326-0006 • FAX: (310) 609-1862
 E-Mail: salesrd@std-wire.com

Arizona

3120 West Thomas Road, Bldg. #801, Phoenix, AZ 85017
 (602) 269-2501 • (800) 325-6478 • FAX: (602) 278-7134
 E-Mail: salesphx@std-wire.com



Standard Wire & Cable Co.

Air Plenum Shielded Pairs



CONDUCTOR: Stranded copper. COLOR: White*.
 INSULATION: Teflon® FEP, Halar® ECTFE, JACKET: Teflon® 200° C, ECTFE 150° C,
 or low smoke PVC. PVDF copolymer 125° C, or low
 VOLTAGE: 150 V smoke PVC 75° C.
 UL: CL2P

CONSTRUCTION: Conductors paired and pairs individually shielded with common stranded tinned copper drain wire.

USES: For use in air plenums without conduit for audio systems, computer systems, and low energy communication and safety control wiring in compliance with the National Fire Protective Association and the National Electric Code, NEC article 725 type CL2P.

Catalog No.	No. of Pairs	AWG Size	Insulation Thickness		Jacket Thickness		Nominal O. D.		Color Code	Put Up (ft)	Weight	
			(in)	(mm)	(in)	(mm)	(in)	(mm)			(lbs / 1000 ft)	(kgs / km)
405-2AGP	2	22	0.006	0.152	0.015	0.381	0.185	4.70	1st pair red-black, 2nd pair green-white	1,000	20	30

Air Plenum Inside Telephone Multi-Pair Category 1 Unshielded Pairs

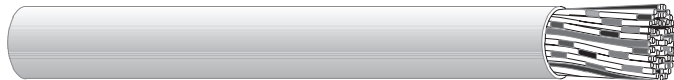

CONDUCTOR: Solid bare copper. COLOR: Gray, beige.*
 INSULATION: Low smoke PVC. JACKET: Low smoke PVC 75° C.
 VOLTAGE: 300 V UL: CMP

CONSTRUCTION: Twisted pairs, varying lays to minimize cross talk, each pair is banded with insulation color mating conductor, nylon rip cord, cabled. Mutual capacitance 36.0 pF/ft. maximum, DC resistance 28.6 ohms/1,000 ft. maximum.

USES: For use in air plenums without conduit for inside wiring runs and connector cable assemblies for multi-line installations such as PBX systems in compliance with the National Fire Protective Association and the National Electric Code, NEC article 800 type CMP. Voice and low-speed data applications.

* Custom jacket colors available.

Teflon® is a trademark of the DuPont de Nemours Co.

Halar® is a trademark of the Allied Chemical Co.

California

1959 East Cashdan Street, Rancho Dominguez, CA 90220
 (310) 609-1811 • (800) 326-0006 • FAX: (310) 609-1862
 E-Mail: salesrd@std-wire.com

Arizona

3120 West Thomas Road, Bldg. #801, Phoenix, AZ 85017
 (602) 269-2501 • (800) 325-6478 • FAX: (602) 278-7134
 E-Mail: salesphx@std-wire.com



Standard Wire & Cable Co.

Air Plenum (cont.)

Inside Telephone Multi-Pair Category 1 Unshielded Pairs

Catalog No.	No. of Pairs	AWG Size	Insulation Thickness		Jacket Thickness		Nominal O. D.		Color Code	Put Up (ft)	Weight	
			(in)	(mm)	(in)	(mm)	(in)	(mm)			(lbs / 1000 ft)	(kgs / km)
401-2FP	2	24	0.006	0.152	0.015	0.381	0.120	3.05	Chart 4 Pg. 33	1,000	8	12
401-3FP	3	24	0.006	0.152	0.015	0.381	0.140	3.56	Chart 4 Pg. 33	1,000	13	19
401-4FP	4	24	0.006	0.152	0.015	0.381	0.160	4.06	Chart 4 Pg. 33	1,000	16	24
401-6FP	6	24	0.006	0.152	0.015	0.381	0.180	4.57	Chart 4 Pg. 33	1,000	22	33
401-12FP	12	24	0.006	0.152	0.015	0.381	0.240	6.10	Chart 4 Pg. 33	1,000	41	61
401-25FP	25	24	0.006	0.152	0.015	0.381	0.330	8.38	Chart 4 Pg. 33	1,000	81	121
401-50FP	50	24	0.006	0.152	0.018	0.457	0.450	11.4	Chart 4 Pg. 33	1,000	156	232
401-75FP	75	24	0.006	0.152	0.018	0.457	0.525	13.3	Chart 4 Pg. 33	1,000	234	348
401-100FP	100	24	0.006	0.152	0.018	0.457	0.785	19.9	Chart 4 Pg. 33	1,000	307	457

Air Plenum

Inside Telephone Multi-Pair Category 1 Overall Shield



CONDUCTOR: Solid bare copper.
 INSULATION: Low smoke PVC.
 VOLTAGE: 300 V

COLOR: Gray, beige.*
 JACKET: Low smoke PVC 75° C.
 UL: CMP

CONSTRUCTION: Twisted pairs, varying lays to minimize cross talk, each pair is banded with insulation color mating conductor, nylon rip cord, cabled. Overall shield of 100% aluminum polyester foil with solid tinned copper drain wire. Mutual capacitance 36.0 pF/ft. maximum, DC resistance 28.6 ohms/1,000 ft. maximum.

USES: For use in air plenums without conduit for inside wiring runs and connector cable assemblies for multi-line installations such as PBX systems in compliance with the National Fire Protective Association and the National Electric Code, NEC article 800 type CMP. Voice and low-speed data applications.

Catalog No.	No. of Pairs	AWG Size	Insulation Thickness		Jacket Thickness		Nominal O. D.		Color Code	Put Up (ft)	Weight	
			(in)	(mm)	(in)	(mm)	(in)	(mm)			(lbs / 1000 ft)	(kgs / km)
401-3FPS	3	24	0.006	0.152	0.015	0.381	0.145	3.68	Chart 4 Pg. 33	1,000	18	27
401-4FPS	4	24	0.006	0.152	0.015	0.381	0.165	4.19	Chart 4 Pg. 33	1,000	24	36
401-6FPS	6	24	0.006	0.152	0.015	0.381	0.185	4.70	Chart 4 Pg. 33	1,000	32	48
401-12FPS	12	24	0.006	0.152	0.015	0.381	0.245	6.22	Chart 4 Pg. 33	1,000	55	82
401-25FPS	25	24	0.006	0.152	0.015	0.381	0.335	8.51	Chart 4 Pg. 33	1,000	112	167

* Custom jacket colors available.

California

1959 East Cashdan Street, Rancho Dominguez, CA 90220
 (310) 609-1811 • (800) 326-0006 • FAX: (310) 609-1862
 E-Mail: salesrd@std-wire.com

Arizona

3120 West Thomas Road, Bldg. #801, Phoenix, AZ 85017
 (602) 269-2501 • (800) 325-6478 • FAX: (602) 278-7134
 E-Mail: salesphx@std-wire.com



Standard Wire & Cable Co.

Air Plenum Inside Telephone Multi-Pair Category 3 Unshielded Pairs



CONDUCTOR: Solid bare copper. COLOR: Gray, beige.*
 INSULATION: Low smoke PVC. VOLTAGE: 300 V
 JACKET: Low smoke PVC 75° C. UL: CMP
 CONSTRUCTION: Twisted pairs, varying lays to minimize cross talk, each pair is banded with insulation color mating conductor, nylon rip cord, cabled. Category 3 cables are produced to the requirements of EIA/TIA-568, Commercial Building Telecommunications Wiring Standard for horizontal cabling. Swept tested up to 16 MHz.

USES: Applications supported include IEEE 802.3 10-Base-T, Ethernet on UTP, and other applications up to and including 10 Mbps data transmission rates. This is the lowest performance level cable recommended by EIA/TIA-568 for voice or data use.

ELECTRICAL SPECIFICATIONS:

Requirement	Test Frequency	Nominal	Specification
Mutual Capacitance:	1 KHz	17.0 pF / ft	20.0 pF / ft max.
Conductor DCR:	DC	26.7 ohms / 1,000 ft	28.6 ohms / 1,000 ft max.
Characteristic Impedance:	1-16 MHz	100 ohms	100 ± 15 ohms

Frequency	Attenuation Max.		Near End Cross Talk Max.		Return Loss Max. (db)
	(db / 1000 ft)	(db / 100 m)	(db / 1000 ft)	(db / 100 m)	
0.772	6.8	2.2	66	22	12
1.0	7.8	2.6	62	20	12
4.0	17	5.6	49	16	12
8.0	26	8.5	43	14	12
10.0	30	9.8	40	13	12
16.0	40	13	35	11	10

Catalog No.	No. of Pairs	AWG Size	Insulation Thickness		Jacket Thickness		Nominal O. D.		Color Code	Put Up (ft)	Weight	
			(in)	(mm)	(in)	(mm)	(in)	(mm)			(lbs / 1000 ft)	(kgs / km)
401-2FP-C3	2	24	0.008	0.203	0.018	0.457	0.144	3.66	Chart 4 Pg. 33	1,000	10	15
401-3FP-C3	3	24	0.008	0.203	0.018	0.457	0.153	3.89	Chart 4 Pg. 33	1,000	14	21
401-4FP-C3	4	24	0.008	0.203	0.018	0.457	0.169	4.29	Chart 4 Pg. 33	1,000	17	25
401-6FP-C3	6	24	0.008	0.203	0.018	0.457	0.198	5.03	Chart 4 Pg. 33	1,000	25	37
401-8FP-C3	8	24	0.008	0.203	0.018	0.457	0.220	5.59	Chart 4 Pg. 33	1,000	32	48
401-12FP-C3	12	24	0.008	0.203	0.018	0.457	0.263	6.68	Chart 4 Pg. 33	1,000	47	70
401-25FP-C3	25	24	0.008	0.203	0.018	0.457	0.382	9.70	Chart 4 Pg. 33	1,000	95	141
401-100FP-C3	100	24	0.008	0.203	0.018	0.457	0.748	19.0	Chart 4 Pg. 33	1,000	383	570

* Custom jacket colors available.

California

1959 East Cashdan Street, Rancho Dominguez, CA 90220
 (310) 609-1811 • (800) 326-0006 • FAX: (310) 609-1862
 E-Mail: salesrd@std-wire.com

Arizona

3120 West Thomas Road, Bldg. #801, Phoenix, AZ 85017
 (602) 269-2501 • (800) 325-6478 • FAX: (602) 278-7134
 E-Mail: salesphx@std-wire.com



Standard Wire & Cable Co.

Air Plenum Inside Telephone Multi-Pair Category 4 Unshielded Pairs



CONDUCTOR: Solid bare copper. COLOR: Gray, beige*.
 INSULATION: FEP VOLTAGE: 300 V
 JACKET: Low smoke PVC 75° C / copolymer. UL: CMP

CONSTRUCTION: Twisted pairs, varying lays to minimize cross talk, each pair is banded with insulation color mating conductor, nylon rip cord, cabled. These cables meet the requirements of EIA/TIA TSB-36 Category 4, and NEMA WC63 Low Loss specifications. Swept tested up to 20 MHz.

USES: Applications supported include IEEE 802.5 16 Mbps UTP, 16 Mbps Token Ring, and other high-speed LAN applications up to and including 20 Mbps data transmission rates. This is the lowest performance level considered as Data Grade UTP.

ELECTRICAL SPECIFICATIONS:

Requirement	Test Frequency	Nominal	Specification
Mutual Capacitance:	1 KHz	15.2 pF / ft	17.0 pF / ft max.
Conductor DCR:	DC	26.7 ohms / 1,000 ft	28.6 ohms / 1,000 ft max.
Characteristic Impedance:	1-20 MHz	100 ohms	100 ± 15 ohms

Frequency	Attenuation Max.		Near End Cross Talk Max.		Return Loss Max. (db)
	(db / 1000 ft)	(db / 100 m)	(db / 1000 ft)	(db / 100 m)	
0.772	5.7	1.9	58	19	21
1.0	6.5	2.1	56	18	21
4.0	13	4.3	47	15	21
8.0	19	6.2	42	14	21
10.0	22	7.2	41	13	21
16.0	27	8.9	38	12	19
20.0	31	10	36	12	18

Catalog No.	No. of Pairs	AWG Size	Insulation Thickness		Jacket Thickness		Nominal O. D.		Color Code	Put Up (ft)	Weight	
			(in)	(mm)	(in)	(mm)	(in)	(mm)			(lbs / 1000 ft)	(kgs / km)
401-2FP-C4	2	24	0.006	0.152	0.018	0.457	0.140	3.56	Chart 4 Pg. 33	1,000	11	16
401-3FP-C4	3	24	0.006	0.152	0.018	0.457	0.148	3.76	Chart 4 Pg. 33	1,000	14	21
401-4FP-C4	4	24	0.006	0.152	0.018	0.457	0.170	4.32	Chart 4 Pg. 33	1,000	18	27
401-6FP-C4	6	24	0.006	0.152	0.018	0.457	0.193	4.90	Chart 4 Pg. 33	1,000	26	39
401-8FP-C4	8	24	0.006	0.152	0.018	0.457	0.223	5.66	Chart 4 Pg. 33	1,000	35	52
401-12FP-C4	12	24	0.006	0.152	0.018	0.457	0.277	7.04	Chart 4 Pg. 33	1,000	52	77
401-25FP-C4	25	24	0.006	0.152	0.018	0.457	0.387	9.83	Chart 4 Pg. 33	1,000	113	168

* Custom jacket colors available.

California

1959 East Cashdan Street, Rancho Dominguez, CA 90220
 (310) 609-1811 • (800) 326-0006 • FAX: (310) 609-1862
 E-Mail: salesrd@std-wire.com

Arizona

3120 West Thomas Road, Bldg. #801, Phoenix, AZ 85017
 (602) 269-2501 • (800) 325-6478 • FAX: (602) 278-7134
 E-Mail: salesphx@std-wire.com



Standard Wire & Cable Co.

Air Plenum Inside Telephone Multi-Pair Category 5 Unshielded Pairs



CONDUCTOR: Solid bare copper. COLOR: Gray, beige.*
 INSULATION: FEP VOLTAGE: 300 V
 JACKET: Low smoke PVC 75° C / copolymer. UL: CMP

CONSTRUCTION: Twisted pairs, varying lays to minimize cross talk, each pair is banded with insulation color mating conductor, nylon rip cord, cabled. These cables meet the requirements of EIA/TIA TSB-36 Category 5, and NEMA WC63 Extended Frequency specifications. Swept tested up to 100 MHz.

USES: Applications supported include ANSI X3T9.5 100 Mbps TP-PMD standard under development, 100 Mbps TPDDI or CDDI (FDDI on UTP), as well as 16 Mbps Token Ring, and other high-speed LAN applications up to and including 100 Mbps data transmission rates. This is the highest level available UTP or Data Grade UTP.

ELECTRICAL SPECIFICATIONS:

Requirement	Test Frequency	Nominal	Specification
Mutual Capacitance:	1 KHz	14.5 pF / ft	10.0 pF / ft max.
Conductor DCR:	DC	26.7 ohms / 1,000 ft	28.6 ohms / 1,000 ft max.
Characteristic Impedance:	1-100 MHz	100 ohms	100 ± 15 ohms

Frequency	Attenuation Max.		Near End Cross Talk Max.		Return Loss Max. (db)
	(db / 1000 ft)	(db / 100 m)	(db / 1000 ft)	(db / 100 m)	
0.772	5.5	1.8	64	21	23
1.0	6.3	2.1	62	20	23
4.0	13	4.3	53	17	23
8.0	18	5.9	48	16	23
10.0	20	6.6	47	15	23
16.0	25	8.2	44	14	23
20.0	28	9.2	42	14	23
25.0	32	10	41	13	22
31.25	36	12	40	13	21
62.5	52	17	35	11	18
100.0	67	22	32	10	16

Catalog No.	No. of Pairs	AWG Size	Insulation Thickness		Jacket Thickness		Nominal O. D.		Color Code	Put Up (ft)	Weight	
			(in)	(mm)	(in)	(mm)	(in)	(mm)			(lbs / 1000 ft)	(kgs / km)
401-2FP-C5	2	24	0.007	0.178	0.015	0.381	0.147	3.73	Chart 4 Pg. 33	1,000	11	16
401-3FP-C5	3	24	0.007	0.178	0.015	0.381	0.156	3.96	Chart 4 Pg. 33	1,000	15	22
401-4FP-C5	4	24	0.007	0.178	0.015	0.381	0.170	4.32	Chart 4 Pg. 33	1,000	23	34
401-6FP-C5	6	24	0.007	0.178	0.015	0.381	0.198	5.03	Chart 4 Pg. 33	1,000	28	42
401-8FP-C5	8	24	0.007	0.178	0.015	0.381	0.208	5.28	Chart 4 Pg. 33	1,000	36	54
401-12FP-C5	12	24	0.007	0.178	0.015	0.381	0.249	6.32	Chart 4 Pg. 33	1,000	55	82
401-25FP-C5	25	24	0.007	0.178	0.020	0.508	0.397	10.1	Chart 4 Pg. 33	1,000	115	171

* Custom jacket colors available.

California

1959 East Cashdan Street, Rancho Dominguez, CA 90220
 (310) 609-1811 • (800) 326-0006 • FAX: (310) 609-1862
 E-Mail: salesrd@std-wire.com

Arizona

3120 West Thomas Road, Bldg. #801, Phoenix, AZ 85017
 (602) 269-2501 • (800) 325-6478 • FAX: (602) 278-7134
 E-Mail: salesphx@std-wire.com



Standard Wire & Cable Co.

Air Plenum Inside Telephone Multi-Pair Category 5 Overall Shield



CONDUCTOR: Solid bare copper.
 INSULATION: FEP
 JACKET: Low smoke PVC 75° C /
 copolymer.

COLOR: Gray, beige*.
 VOLTAGE: 300 V
 UL: CMP

CONSTRUCTION: Twisted pairs, varying lays to minimize cross talk, each pair is banded with insulation color mating conductor, nylon rip cord, cabled. Overall shield of 100% aluminum polyester foil with solid tinned copper drain wire. These cables meet the requirements of EIA/TIA TSB-36 Category 5, and NEMA WC63 Extended Frequency specifications. Swept tested up to 100 MHz.

USES: Applications supported include ANSI X3T9.5 100 Mbps TP-PMD standard under development, 100 Mbps TPDDI or CDDI (FDDI on UTP), as well as 16 Mbps Token Ring, and other high-speed LAN applications up to and including 100 Mbps data transmission rates. This is the highest level available UTP or Data Grade UTP.

ELECTRICAL SPECIFICATIONS:

Requirement	Test Frequency	Nominal	Specification
Mutual Capacitance:	1 KHz	14.5 pF / ft	10.0 pF / ft max.
Conductor DCR:	DC	26.7 ohms / 1,000 ft	28.6 ohms / 1,000 ft max.
Characteristic Impedance:	1-100 MHz	100 ohms	100 ± 15 ohms

Frequency	Attenuation Max.		Near End Cross Talk Max.		Return Loss Max. (db)
	(db / 1000 ft)	(db / 100 m)	(db / 1000 ft)	(db / 100 m)	
0.772	5.5	1.8	64	21	23
1.0	6.3	2.1	62	20	23
4.0	13	4.3	53	17	23
8.0	18	5.9	48	16	23
10.0	20	6.6	47	15	23
16.0	25	8.2	44	14	23
20.0	28	9.2	42	14	23
25.0	32	10	41	13	22
31.25	36	12	40	13	21
62.5	52	17	35	11	18
100.0	67	22	32	10	16

Catalog No.	No. of Pairs	AWG Size	Insulation Thickness		Jacket Thickness		Nominal O. D.		Color Code	Put Up (ft)	Weight	
			(in)	(mm)	(in)	(mm)	(in)	(mm)			(lbs / 1000 ft)	(kgs / km)
401-2FPS-C5	2	24	0.011	0.279	0.025	0.635	0.180	4.57	Chart 4 Pg. 33	1,000	16	24
401-3FPS-C5	3	24	0.011	0.279	0.025	0.635	0.190	4.83	Chart 4 Pg. 33	1,000	19	28
401-4FPS-C5	4	24	0.011	0.279	0.025	0.635	0.210	5.33	Chart 4 Pg. 33	1,000	24	36
401-6FPS-C5	6	24	0.011	0.279	0.025	0.635	0.250	6.35	Chart 4 Pg. 33	1,000	32	48
401-8FPS-C5	8	24	0.011	0.279	0.025	0.635	0.311	7.90	Chart 4 Pg. 33	1,000	41	61
401-12FPS-C5	12	24	0.011	0.279	0.025	0.635	0.320	8.13	Chart 4 Pg. 33	1,000	58	86
401-25FPS-C5	25	24	0.011	0.279	0.035	0.889	0.500	12.7	Chart 4 Pg. 33	1,000	114	170

* Custom jacket colors available.

California

1959 East Cashdan Street, Rancho Dominguez, CA 90220
 (310) 609-1811 • (800) 326-0006 • FAX: (310) 609-1862
 E-Mail: salesrd@std-wire.com

Arizona

3120 West Thomas Road, Bldg. #801, Phoenix, AZ 85017
 (602) 269-2501 • (800) 325-6478 • FAX: (602) 278-7134
 E-Mail: salesphx@std-wire.com



Standard Wire & Cable Co.

Air Plenum Sound and Intercom Shielded Pairs



CONDUCTOR: Stranded bare copper. COLOR: White*.
 INSULATION: Teflon® FEP, Halar® ECTFE, JACKET: Teflon® 200° C, ECTFE 150° C,
 or low smoke PVC. PVDF copolymer 125° C, or low
 VOLTAGE: 150 V smoke PVC 75° C.
 UL: CL2P

CONSTRUCTION: Conductors paired and pairs individually shielded with stranded tinned copper drain wire.

USES: For use in air plenums without conduit for audio, intercom, computer systems, and low energy communication and safety control wiring in compliance with the National Fire Protective Association and the National Electric Code, NEC article 725 type CL2P.

Catalog No.	No.** of Pairs	AWG Size	Insulation Thickness		Jacket Thickness		Nominal O.D.		Color Code	Put Up (ft)	Weight	
			(in)	(mm)	(in)	(mm)	(in)	(mm)			(lbs / 1000 ft)	(kgs / km)
405-2APL	2	22	0.006	0.152	0.015	0.381	0.197	5.00	Chart 3 Pg. 33	1,000	20	30
405-3APL	3	22	0.006	0.152	0.015	0.381	0.211	5.36	Chart 3 Pg. 33	1,000	21	31
405-6APL	6	22	0.006	0.152	0.015	0.381	0.266	6.76	Chart 3 Pg. 33	1,000	24	36

Air Plenum Unshielded Fire Alarm Cable



CONDUCTOR: Solid bare copper. COLOR: Red*.
 INSULATION: Teflon® FEP, Halar® ECTFE, JACKET: Teflon® 200° C, ECTFE 150° C,
 or low smoke PVC. PVDF copolymer 125° C, or low
 VOLTAGE: 300 V smoke PVC 75° C.
 CONSTRUCTION: Conductors cabled. UL: FPLP

USES: For use in air plenums without conduit for fire alarm systems in compliance with the National Fire Protective Association and the National Electric Code, NEC article 760 type FPLP.

Catalog No.	No.** of Cond.	AWG Size	Insulation Thickness		Jacket Thickness		Nominal O. D.		Color Code	Put Up (ft)	Weight	
			(in)	(mm)	(in)	(mm)	(in)	(mm)			(lbs / 1000 ft)	(kgs / km)
400-16FPL	2	18	0.010	0.254	0.013	0.330	0.140	3.56	Chart 5 Pg. 33	1,000	18	27
400-20FPL	4	18	0.010	0.254	0.013	0.330	0.165	4.19	Chart 5 Pg. 33	1,000	32	48
1327-6FPL	6	18	0.010	0.254	0.013	0.330	0.205	5.21	Chart 5 Pg. 33	1,000	46	68
1327-8FPL	8	18	0.010	0.254	0.013	0.330	0.220	5.59	Chart 5 Pg. 33	1,000	60	89
400-25FPL	2	16	0.010	0.254	0.013	0.330	0.170	4.32	Chart 5 Pg. 33	1,000	26	39

*Custom jacket colors available.

** Consult Standard Wire & Cable Co.'s sales department for pair/conductor counts not listed.

Teflon® is a trademark of the DuPont de Nemours Co.

Halar® is a trademark of the Allied Chemical Co.

California

1959 East Cashdan Street, Rancho Dominguez, CA 90220
 (310) 609-1811 • (800) 326-0006 • FAX: (310) 609-1862
 E-Mail: salesrd@std-wire.com

Arizona

3120 West Thomas Road, Bldg. #801, Phoenix, AZ 85017
 (602) 269-2501 • (800) 325-6478 • FAX: (602) 278-7134
 E-Mail: salesphx@std-wire.com



Standard Wire & Cable Co.

Air Plenum Shielded Fire Alarm Cable



CONDUCTOR: Solid bare copper. COLOR: Red.
 INSULATION: Teflon® FEP, Halar® ECTFE, JACKET: Teflon® 200° C, ECTFE 150° C,
 or low smoke PVC. PVDF copolymer 125° C, or low
 VOLTAGE: 300 V smoke PVC 75° C.
 UL: FPLP

CONSTRUCTION: Conductors cabled. Overall shield of 100% aluminum polyester foil with a stranded tinned copper drain wire.

USES: For use in air plenums without conduit for fire alarm systems in compliance with the National Fire Protective Association and the National Electric Code, NEC article 760 type FPLP.

Catalog No.	No. of Cond.	AWG Size	Insulation Thickness		Jacket Thickness		Nominal O. D.		Color Code	Put Up (ft)	Weight	
			(in)	(mm)	(in)	(mm)	(in)	(mm)			(lbs / 1000 ft)	(kgs / km)
504-67FAP	2	18	0.010	0.254	0.013	0.330	0.150	3.81	Chart 1 Pg. 33	1,000	22	33
504-72FAP	4	18	0.010	0.254	0.013	0.330	0.180	4.57	Chart 1 Pg. 33	1,000	36	54
504-74FAP	2	16	0.010	0.254	0.013	0.330	0.170	4.32	Chart 1 Pg. 33	1,000	31	46

Teflon® is a trademark of the DuPont de Nemours Co.

Halar® is a trademark of the Allied Chemical Co.

Microminim® Ultra-Flex Micro-Miniature Wire & Cable

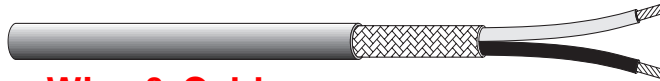

INSULATION: A special compound of synthetic resin which has been formulated for maximum flexibility and dielectric reliability.

USES: Essentially for use as instrument lead wire (sensors, guidance controls, etc.)

Catalog No.	No. of Cond.	AWG Size	Stranding	Nominal Diameter		Nominal Diameter Over Shield		Nominal Diameter Over Jacket		Weight	
				(in)	(mm)	(in)	(mm)	(in)	(mm)	(lbs / 1000 ft)	(kgs / km)
503-6B	1	29	16/40 TC	0.064	1.63	0.076	1.93	0.090	2.29	4.20	6.25
503-6C	1	29	16/40 TC	0.046	1.17	0.058	1.47	0.072	1.83	3.50	5.21
801-10	1	29	51/46 BC	0.030	0.762	N/A				0.75	1.12
503-7C	1	29	51/46 BC	0.030	0.762	0.042	1.07	0.058	1.47	2.30	3.42
402-1F	2	29	51/46 BC	0.060	1.52	N/A				1.50	2.23
504-1B	2	29	51/46 BC	0.060	1.52	0.072	1.83	0.086	2.18	4.30	6.40
504-2B	3	29	51/46 BC	0.066	1.68	0.078	1.98	0.092	2.34	4.50	6.70
801-30	1	26	66/44 BC	0.042	1.07	N/A				1.40	2.08
503-9C	1	26	66/44 BC	0.042	1.07	0.054	1.37	0.069	1.75	2.80	4.17
504-5B	2	26	66/44 BC	0.084	2.13	0.096	2.44	0.106	2.69	6.00	8.93
504-6B	3	26	66/44 BC	0.092	2.34	0.104	2.64	0.114	2.90	7.30	10.9
801-45	1	24	41/40 TC	0.056	1.42	N/A				2.50	3.72

Electrical data furnished upon request. Standard color is gray. Other colors available upon request.

Microminim® is a trademark of Standard Wire & Cable Co.

California

1959 East Cashdan Street, Rancho Dominguez, CA 90220
 (310) 609-1811 • (800) 326-0006 • FAX: (310) 609-1862
 E-Mail: salesrd@std-wire.com

Arizona

3120 West Thomas Road, Bldg. #801, Phoenix, AZ 85017
 (602) 269-2501 • (800) 325-6478 • FAX: (602) 278-7134
 E-Mail: salesphx@std-wire.com



Standard Wire & Cable Co.

Coaxial Cable Commercial Type



CONSTRUCTION: Stranded or solid, bare or tinned, copper or copper-clad steel conductor, polyethylene, semisolid polyethylene, polyethylene foam dielectric, bare or tinned copper braid shield.

JACKET: PVC

USES: For use in the interconnection of data processing equipment, information systems, LAN's, CATV, CCTV, MATV, and two-way radio in compliance with the National Electric Code, NEC article 725 type CL2 or UL 1354 and UL 1478.

Catalog No.	Type	Nom. Imp. (ohms)	Nom. Cap. (pF / ft) (pF / m)		Inner Cond. Size/Type	Vel. of Prop.	Dielectric Material	Dielectric Diameter (in) (mm)		Shield	Jacket	Nominal O.D. (in) (mm)		UL Style / NEC Type	Put Up (ft)	Weight (lbs / 1000 ft) (kgs / km)	
507-8	RG8/U	52	29.5	8.99	7/21 BC	66%	PE	0.285	7.24	95% BC braid	PVC, black	0.405	10.3	1354	1,000	105	156
507-8A	RG8A/U	52	29.5	8.99	7/21 BC	66%	PE	0.285	7.24	95% BC braid	PVC IIA, black	0.405	10.3	1354	1,000	103	153
507-8F	RG8/U	50	26	7.9	7/21 BCCS	78%	PE foam	0.285	7.24	80% BC braid	PVC, black	0.405	10.3	1354	1,000	100	149
507-8P	RG8/U	52	29.5	8.99	7/21 BCCS	66%	PE	0.285	7.24	80% BC braid	PVC, black	0.405	10.3	1354	1,000	100	149
507-11	RG11/U	75	20.5	6.25	7/26 TC	66%	PE	0.285	7.24	95% BC braid	PVC, black	0.405	10.3	1354	1,000	97	144
507-11A	RG11A/U	75	20.5	6.25	7/26 TC	66%	PE	0.285	7.24	95% BC braid	PVC IIA, black	0.405	10.3	1354	1,000	97	144
507-11F	RG11/U	75	17.3	5.27	14 AWG BC	78%	PE foam	0.285	7.24	80% BC braid	PVC, black	0.405	10.3	1354	1,000	93	138
507-11P	RG11/U	75	20.5	6.25	7/26 TC	66%	PE	0.285	7.24	80% BC braid	PVC, black	0.405	10.3	1354	1,000	93	138
507-58	RG58/U	53.5	28.5	8.69	20 AWG BC	66%	PE	0.116	2.95	95% TC braid	PVC, black	0.195	4.95	1354	1,000	27	40
507-58A	RG58A/U	50	30	9.1	19/33 TC	66%	PE	0.116	2.95	95% TC braid	PVC, black	0.195	4.95	1354	1,000	27	40
507-58C	RG58C/U	50	30	9.1	19/33 TC	66%	PE	0.116	2.95	95% TC braid	PVC IIA, black	0.195	4.95	N/A	1,000	26	39
507-58P	RG58/U	53.5	28.5	8.69	20 AWG BC	66%	PE	0.116	2.95	80% TC braid	PVC, black	0.195	4.95	1354	1,000	27	40
507-59	RG59/U	73	21.0	6.40	22 AWG BCCS	66%	PE	0.144	3.66	95% BC braid	PVC, black	0.242	6.15	1354 CL2	1,000	41	61
507-59AF	RG59A/U	75	17.3	5.27	20 AWG BCCS	78%	PE foam	0.146	3.71	95% BC braid	PVC, black	0.242	6.15	1354 CL2	1,000	32	48
507-59BF	RG59/U	75	17.3	5.27	20 AWG BC	78%	PE foam	0.146	3.71	95% BC braid	PVC, black	0.242	6.15	1354 CL2	1,000	31	46
507-59P	RG59/U	73	21.0	6.40	22 AWG BCCS	66%	PE	0.144	3.66	80% BC braid	PVC, black	0.242	6.15	1354 CL2	1,000	28	42
507-62	RG62/U	93	13.5	4.11	22 AWG BCCS	84%	Semisolid PE	0.144	3.66	95% BC braid	PVC, black	0.242	6.15	1478 CL2	1,000	37	55
507-62A	RG62A/U	93	13.5	4.11	22 AWG BCCS	84%	Semisolid PE	0.144	3.66	95% BC braid	PVC IIA, black	0.242	6.15	1478 CL2	1,000	35	52
507-62AP	RG62A/U	93	13.5	4.11	22 AWG BCCS	84%	Semisolid PE	0.144	3.66	80% BC braid	PVC, black	0.242	6.15	1478 CL2	1,000	35	52

California

1959 East Cashdan Street, Rancho Dominguez, CA 90220
 (310) 609-1811 • (800) 326-0006 • FAX: (310) 609-1862
 E-Mail: salesrd@std-wire.com

Arizona

3120 West Thomas Road, Bldg. #801, Phoenix, AZ 85017
 (602) 269-2501 • (800) 325-6478 • FAX: (602) 278-7134
 E-Mail: salesphx@std-wire.com



Standard Wire & Cable Co.

Coaxial Cable Air Plenum



CONSTRUCTION: Stranded or solid, bare or tinned, copper or copper-clad steel conductor, FEP and FEP foam dielectric, bare or tinned copper braid shield, and/or aluminum mylar shield(s).

JACKET: Teflon® 200° C, ECTFE 150° C, PVDF copolymer 125° C, or low smoke PVC 75° C.

USES: For use in air plenums without conduit for the interconnection of data processing equipment, information systems, LAN's, CATV, CCTV, MATV, and two-way radio in compliance with the National Fire Protective Association and the National Electric Code, NEC article 725 type CL2P.

Catalog No.	Type	Nom. Imp. (ohms)	Nom. Cap.		Inner Cond. Size/Type	Vel. of Prop.	Dielectric Material	Dielectric Diameter		Shield	Nominal O. D.		Put Up (ft)	Weight	
			(pF / ft)	(pF / m)				(in)	(mm)		(in)	(mm)		(lbs / 1000 ft)	(kgs / km)
507-6FAP	RG6/U	75.00	16.50	5.029	18 AWG BCCS	82%	FEP foam	0.170	4.32	AL/MY, 80% AL braid	0.243	6.17	1,000	40.0	59.5
507-6FBP	RG6/U	75.00	16.50	5.029	18 AWG BC	82%	FEP foam	0.170	4.32	AL/MY, 80% AL braid	0.243	6.17	1,000	40.0	59.5
507-6QP	RG6/U	75.00	16.50	5.029	18 AWG BCCS	82%	FEP foam	0.170	4.32	AL/MY, 60% Al braid, AL/MY, 40% AL braid	0.273	6.93	1,000	57.0	84.8
507-6QBP	RG6/U	75.00	16.90	5.151	18 AWG BC	82%	FEP foam	0.170	4.32	AL/MY, 60% Al braid, AL/MY, 40% AL braid	0.273	6.93	1,000	57.0	84.8
507-58PL	RG58/U	53.50	27.00	8.230	20AWG BC	69%	FEP	0.112	2.84	95% BC braid	0.178	4.52	1,000	27.0	40.2
507-58APL	RG58A/U	50.00	29.50	8.992	20AWG 19/33 TC	69%	FEP	0.110	2.79	95% TC braid	0.166	4.22	1,000	27.0	40.2
507-58PTN	RG58 Thinner	50.00	29.50	7.620	20AWG 19/32 TC	78%	FEP foam	0.100	2.54	95% TC braid, AL/MY	0.165	4.19	1,000	27.0	40.2
507-59FAP	RG59/U	75.00	16.90	5.151	20 AWG BC	82%	FEP foam	0.170	4.32	AL/MY, 80% AL braid	0.213	5.41	1,000	38.0	56.5
507-59PL	RG59/U	75.00	16.00	4.877	20AWG BCCS	82%	FEP foam	0.140	3.56	95% BC braid	0.200	5.08	1,000	32.0	47.6
507-62APL	RG62A/U	93.00	12.80	3.901	22AWG BCCS	84%	FEP foam	0.144	3.66	95% BC braid	0.200	5.08	1,000	40.0	59.5

Teflon® is a trademark of the DuPont de Nemours Co.

California

1959 East Cashdan Street, Rancho Dominguez, CA 90220
(310) 609-1811 • (800) 326-0006 • FAX: (310) 609-1862
E-Mail: salesrd@std-wire.com

Arizona

3120 West Thomas Road, Bldg. #801, Phoenix, AZ 85017
(602) 269-2501 • (800) 325-6478 • FAX: (602) 278-7134
E-Mail: salesphx@std-wire.com



Standard Wire & Cable Co.

Coaxial Cable CATV-CCTV



CONSTRUCTION: Solid bare copper or copper-clad steel conductors, polyethylene foam dielectric, aluminum braid, and aluminum polyester foil shields.

JACKET: PVC

USES: For use in CATV, CCTV, and MATV systems in compliance with the National Electric Code, NEC article 725 type CL2.

Catalog No.	Type	Nom. Imp. (ohms)	Nom. Cap.		Inner Cond. Size/Type	Vel. of Prop.	Dielectric Material	Dielectric Diameter		Shield	Jacket	Nominal O.D.		Put Up (ft)	Weight	
			(pF / ft)	(pF / m)				(in)	(mm)			(in)	(mm)		(lbs / 1000 ft)	(kgs / km)
507-6F	RG6/U	75	17.3	5.27	18 AWG BCCS	78%	PE foam	0.182	4.62	40% AL braid, AL/MY	PVC, black, white	0.270	6.86	1,000	30	45
507-6FA	RG6/U	75	17.3	5.27	18 AWG BCCS	78%	PE foam	0.182	4.62	60% AL braid, AL/MY	PVC, black, white	0.270	6.86	1,000	34	51
507-6FBC	RG6/U	75	17.3	5.27	18 AWG BC	78%	PE foam	0.182	4.62	60% AL braid, AL/MY	PVC, black, white	0.270	6.86	1,000	34	51
507-6Q	RG6/U	75	16.2	4.94	18 AWG BCCS	78%	PE foam	0.180	4.57	40% AL braid, 60% AL braid, + two AL/MY	PVC, black, white	0.302	7.67	1,000	59	88
507-6QBC	RG6/U	75	16.2	4.94	18 AWG BC	78%	PE foam	0.180	4.57	40% AL braid, 60% AL braid, + two AL/MY	PVC, black, white	0.302	7.67	1,000	59	88
507-59F	RG59/U	75	17.5	5.33	20 AWG BCCS	78%	PE foam	0.146	3.71	40% AL braid, AL/MY	PVC, black, white	0.242	6.15	1,000	22	33
507-59FA	RG59/U	75	17.5	5.33	20 AWG BCCS	78%	PE foam	0.146	3.71	60% AL braid, AL/MY	PVC, black, white	0.242	6.15	1,000	25	37
507-59Q	RG59/U	75	16.2	4.94	20 AWG BCCS	78%	PE foam	0.146	3.71	40% AL braid, 60% AL braid, + two AL/MY	PVC, black, white	0.272	6.91	1,000	33	49

Coaxial Cable Thinnet



CONSTRUCTION: Stranded tinned copper conductor, polyethylene foam dielectric, tinned copper braid, and aluminum polyester foil shields.

JACKET: PVC

USES: For use in the interconnection of data processing equipment, information systems, LAN's, CATV, CCTV, MATV, and two-way radio in compliance with the National Electric Code, NEC article 725 type CL2, IEEE 802.3.

Catalog No.	Type	Nom. Imp. (ohms)	Nom. Cap.		Inner Cond. Size/Type	Vel. of Prop.	Dielectric Material	Dielectric Diameter		Shield	Jacket	Nominal O. D.		Put Up (ft)	Weight	
			(pF / ft)	(pF / m)				(in)	(mm)			(in)	(mm)		(lbs / 1000 ft)	(kgs / km)
507-58TN	RG58C/U Thinnet	50	27	8.2	19/32 TC	78%	PE foam	0.102	2.59	95% TC braid, AL/MY	PVC, black, gray	0.183	4.65	1,000	19	28

California

1959 East Cashdan Street, Rancho Dominguez, CA 90220
 (310) 609-1811 • (800) 326-0006 • FAX: (310) 609-1862
 E-Mail: salesrd@std-wire.com

Arizona

3120 West Thomas Road, Bldg. #801, Phoenix, AZ 85017
 (602) 269-2501 • (800) 325-6478 • FAX: (602) 278-7134
 E-Mail: salesphx@std-wire.com



Standard Wire & Cable Co.

Coaxial Cable Precision Video

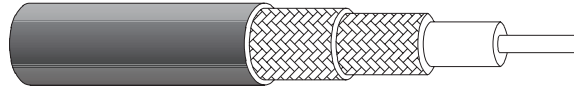

CONSTRUCTION: Solid bare copper conductor, solid polyethylene dielectric, tinned copper braid shields.

JACKET: PVC or polyethylene.

USES: For use in the interconnection of video signal transmission equipment in television stations in compliance with the National Electric Code, NEC article 725 type CL2, where applicable.

Catalog No.	Nom. Imp. (ohms)	Nom. Cap.		Inner Cond. Size / Type	Vel. of Prop.	Dielectric Material	Dielectric Diameter		Shield	Jacket	Nominal O.D.		UL Style / NEC Type	Put Up (ft)	Weight	
		(pF / ft)	(pF / m)				(in)	(mm)			(in)	(mm)			(lbs / 1000 ft)	(kgs / km)
507-6P	75	21	6.4	20 AWG BC	66%	PE	0.198	5.03	98% TC double braid	PVC, gray	0.305	7.75	CL2	1,000	76	113
507-6PV	75	21	6.4	20 AWG BC	66%	PE	0.198	5.03	96% TC double braid	polyethylene, black, blue	0.305	7.75	N/A	1,000	74	110

Coaxial Cable Twinax Cable

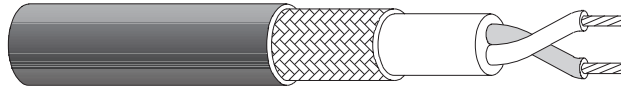

CONSTRUCTION: Stranded bare or tinned copper conductors, solid polyethylene dielectric, twisted core assembly, aluminum polyester foil shields, and tinned copper braid with stranded tinned copper drain wire.

JACKET: PVC

USES: For use in standard computer peripheral interconnection in baseband networks performing up to 10 Mbps in compliance with the National Electric Code, NEC article 800 type CM.

Catalog No.	Nom. Imp. (ohms)	Nom. Cap.		No. of Cond.	Inner Cond. Size / Type	Vel. of Prop.	Dielectric Material	Shield	Jacket	Nominal O.D.		Put Up (ft)	Weight	
		(pF / ft)	(pF / m)							(in)	(mm)		(lbs / 1000 ft)	(kgs / km)
504-40	78	19.8	6.04	2	20 AWG 7/28 TC	66%	PE	93% TC braid	PVC, blue	0.24	6.1	1,000	40	60
504-42	100	15.4	4.69	2	20 AWG 7/28 one TC one BC	66%	PE	95% TC braid	PVC, black	0.33	8.4	1,000	62	92
504-7	124	12.4	3.78	2	25 AWG 7/33 TC	66%	PE	AL/MY, stranded TC drain wire	PVC, blue	0.242	6.15	1,000	26	39

California

1959 East Cashdan Street, Rancho Dominguez, CA 90220
(310) 609-1811 • (800) 326-0006 • FAX: (310) 609-1862
E-Mail: salesrd@std-wire.com

Arizona

3120 West Thomas Road, Bldg. #801, Phoenix, AZ 85017
(602) 269-2501 • (800) 325-6478 • FAX: (602) 278-7134
E-Mail: salesphx@std-wire.com



Standard Wire & Cable Co.

National Electric Code

The 1990 National Electric Code set forth a new category and organization of multipurpose cables. These fall into articles 725, 760, and 800. The diagram below summarizes the new categories and organization. Solid lines with arrows indicate substitution may be made in the direction of the arrow. Dashed lines with arrows indicate substitution with restrictions may be made in the direction of the arrow.

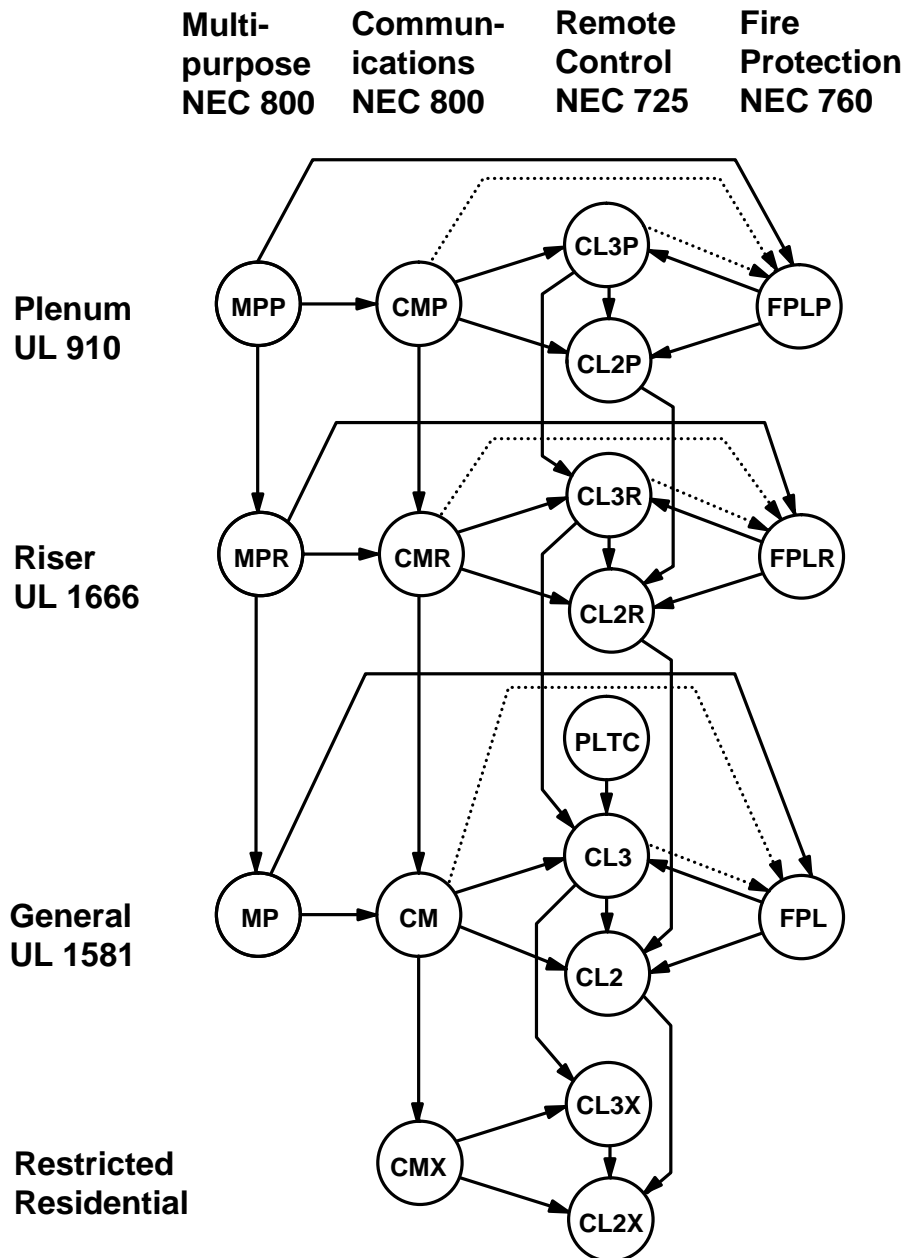

Note that local fire marshals enforce their municipal codes in accordance with their local laws. Awareness of these local codes is essential.

California

1959 East Cashdan Street, Rancho Dominguez, CA 90220
(310) 609-1811 • (800) 326-0006 • FAX: (310) 609-1862
E-Mail: salesrd@std-wire.com

Arizona

3120 West Thomas Road, Bldg. #801, Phoenix, AZ 85017
(602) 269-2501 • (800) 325-6478 • FAX: (602) 278-7134
E-Mail: salesphx@std-wire.com



Color Code Charts

COLOR CODE CHART NO. 1	
COND.	COLOR
1	Black
2	Red
3	White
4	Green
5	Brown
6	Blue
7	Orange
8	Yellow
9	Purple
10	Gray
11	Pink
12	Tan

COLOR CODE CHART NO. 2			
COND.	COLOR	COND.	COLOR
1	Black	26	Orange / Black / White
2	White	27	Blue / Black / White
3	Red	28	Black / Red / Green
4	Green	29	White / Red / Green
5	Orange	30	Red / Black / Green
6	Blue	31	Green / Black / Orange
7	White / Black	32	Orange / Black / Green
8	Red / Black	33	Blue / White / Orange
9	Green / Black	34	Black / White / Orange
10	Orange / Black	35	White / Red / Orange
11	Blue / Black	36	Orange / White / Blue
12	Black / White	37	White / Red / Blue
13	Red / White	38	Black / White / Green
14	Green / White	39	White / Black / Green
15	Blue / White	40	Red / White / Green
16	Black / Red	41	Green / White / Blue
17	White / Red	42	Orange / Red / Green
18	Orange / Red	43	Blue / Red / Green
19	Blue / Red	44	Black / White / Blue
20	Red / Green	45	White / Black / Blue
21	Orange / Green	46	Red / White / Blue
22	Black / White / Red	47	Green / Orange / Red
23	White / Black / Red	48	Orange / Red / Blue
24	Red / Black / White	49	Blue / Red / Orange
25	Green / Black / White	50	Black / Orange / Red

COLOR CODE CHART NO. 3			
PAIR	COLOR	PAIR	COLOR
1	Black with Red	27	Brown with Yellow
2	Black with White	28	Purple with Red
3	Black with Green	29	Purple with White
4	Black with Blue	30	Purple with Green
5	Black with Brown	31	Purple with Blue
6	Black with Yellow	32	Purple with Brown
7	Black with Orange	33	Purple with Yellow
8	Red with Green	34	Purple with Orange
9	Red with White	35	Purple with Slate
10	Red with Blue	36	Purple with Black
11	Red with Yellow	37	Slate with Red
12	Red with Brown	38	Slate with White
13	Red with Orange	39	Slate with Green
14	Green with Blue	40	Slate with Blue
15	Green with White	41	Slate with Brown
16	Green with Brown	42	Slate with Yellow
17	Green with Orange	43	Slate with Orange
18	Green with Yellow	44	Slate with Black
19	White with Blue	45	White / Black with Red
20	White with Brown	46	White / Black with Green
21	White with Orange	47	White / Black with Blue
22	White with Yellow	48	White / Black with Brown
23	Blue with Brown	49	White / Black with Yellow
24	Blue with Orange	50	White / Black with Orange
25	Blue with Yellow	51	White / Black with Purple
26	Brown with Orange		

COLOR CODE CHART NO. 4 (RING BAND)			
PAIR	COLOR	PAIR	COLOR
1	White-Blue paired with Blue-White	14	Black-Brown paired with Brown-Black
2	White-Orange paired with Orange-White	15	Black-Slate paired with Slate-Black
3	White-Green paired with Green-White	16	Yellow-Blue paired with Blue-Yellow
4	White-Brown paired with Brown-White	17	Yellow-Orange paired with Orange-Yellow
5	White-Slate paired with Slate-White	18	Yellow-Green paired with Green-Yellow
6	Red-Blue paired with Blue-Red	19	Yellow-Brown paired with Brown-Yellow
7	Red-Orange paired with Orange-Red	20	Yellow-Slate paired with Slate-Yellow
8	Red-Green paired with Green-Red	21	Violet-Blue paired with Blue-Violet
9	Red-Brown paired with Brown-Red	22	Violet-Orange paired with Orange-Violet
10	Red-Slate paired with Slate-Red	23	Violet-Green paired with Green-Violet
11	Black-Blue paired with Blue-Black	24	Violet-Brown paired with Brown-Violet
12	Black-Orange paired with Orange-Black	25	Violet-Slate paired with Slate-Violet
13	Black-Green paired with Green-Black		

COLOR CODE CHART NO. 5	
COND.	COLOR
1	Black
2	Red
3	Brown
4	Blue
5	Orange
6	Yellow
7	Violet
8	Pink
9	Tan
10	Gray

COLOR CODE CHART NO. 6 (MIL-STD-681D)	
ID NO.	BASE COLOR
0	Black
1	Brown
2	Red
3	Orange
4	Yellow
5	Green
6	Blue
7	Violet
8	Gray
9	White

California

1959 East Cashdan Street, Rancho Dominguez, CA 90220
 (310) 609-1811 • (800) 326-0006 • FAX: (310) 609-1862
 E-Mail: salesrd@std-wire.com

Arizona

3120 West Thomas Road, Bldg. #801, Phoenix, AZ 85017
 (602) 269-2501 • (800) 325-6478 • FAX: (602) 278-7134
 E-Mail: salesphx@std-wire.com



Standard Wire & Cable Co.

Traffic Signal Cable Cal-Trans Loop Detector Lead-In Cable



CONDUCTOR: Stranded tinned copper. JACKET: High-density polyethylene, black.
 INSULATION: Polyethylene.
 CONSTRUCTION: Aluminum polyester shield with 20 AWG stranded tinned copper drain wire. Interior moisture penetration filler of nonhygroscopic polypropylene in type B cables.
 USES: Loop detector lead-in cable, from the pull box adjacent to the loop to the field terminals in the cabinet. Meets Cal-Trans specifications.

Catalog No.	Type	AWG Size	Stranding	Insulation Thickness		Moisture Barrier	Jacket Thickness		Nominal O. D.		Put Up (ft)	Weight	
				(in)	(mm)		(in)	(mm)	(in)	(mm)		(lbs / 1000 ft)	(kgs / km)
504-74B	B	16	19/29	0.020	0.508	yes	0.035	0.889	0.310	7.87	2,500	37	55
504-74C	C	16	19/29	0.020	0.508	no	0.035	0.889	0.285	7.24	2,500	34	51

Consult Standard Wire & Cable Co.'s sales department for other traffic signal and IMSA cables.

Traffic Signal Cable Inductance Loop Detector Wire DETECTA-DUCT®



CONDUCTOR: Stranded bare copper. JACKET: PVC 105° C.
 INSULATION: PVC / nylon (THHN). COLOR: Black, orange.
 CONSTRUCTION: THHN wire loosely encased in a tube of polyvinylchloride. VOLTAGE: 600 V
 USES: Traffic signal inductance loop detector wire. Meets both Cal-Trans type 2 and IMSA Spec. No. 51-5 requirements. Detecta-Duct® is a trademark of Standard Wire & Cable Co., the originator of tubed loop wire.

Catalog No.	AWG Size	Stranding	Insulation Thickness PVC		Insulation Thickness Nylon		Jacket Thickness		Nominal I. D.		Nominal O. D.		Put Up (ft)	Weight	
			(in)	(mm)	(in)	(mm)	(in)	(mm)	(in)	(mm)	(in)	(mm)		(lbs / 1000 ft)	(kgs / km)
903-1	14	19/27	0.015	0.381	0.004	0.102	0.03	0.76	0.19	4.8	0.250	6.35	2,500	28	42
903-2*	14	19/27	0.015	0.381	0.004	0.102	0.03	0.76	0.15	3.8	0.210	5.33	2,500	26	39

* Cal-Trans reduced diameter cable.

Detecta-Duct® is a trademark of Standard Wire & Cable Co.

California

1959 East Cashdan Street, Rancho Dominguez, CA 90220
 (310) 609-1811 • (800) 326-0006 • FAX: (310) 609-1862
 E-Mail: salesrd@std-wire.com

Arizona

3120 West Thomas Road, Bldg. #801, Phoenix, AZ 85017
 (602) 269-2501 • (800) 325-6478 • FAX: (602) 278-7134
 E-Mail: salesphx@std-wire.com



Standard Wire & Cable Co.

Retractable Cords Flexoprene®

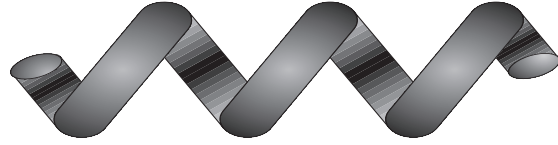

CONDUCTOR: Stranded bare copper.

INSULATION: Rubber.

TEMPERATURE: 90° C.

USES: Any power cable that requires mobility such as truck trailers and magnetic cranes.

CONSTRUCTION: Multi-conductor stranded, length 48 in. retracted, 20 ft. extended. Also available in lengths of 12, 24, and 36 in.

Catalog No.	No. of Cond.	AWG Size	Stranding	UL Type	Max. Working Voltage	Cond. Amp Rating	Cable O.D.		Coil O.D.		Weight	
							(in)	(mm)	(in)	(mm)	(lbs / 48 in)	(kgs / 12.2 cm)
18 AWG												
710-1	2	18	41/34	SVO	300	7	0.260	6.60	7/8	22.2	1.3	1.9
710-2	2	18	41/34	SJO	300	7	0.320	8.13	1-3/16	30.2	1.8	2.7
710-3	3	18	41/34	SJO	300	7	0.350	8.89	1-3/8	34.9	2.3	3.4
710-3A	3	18	41/34	SVO	300	7	0.275	6.99	1	25.4	1.5	2.2
710-3B	3	18	41/34	SO	600	7	0.425	10.8	1-9/16	39.7	3.3	4.9
710-4	4	18	41/34	SJO	300	5.6	0.385	9.78	1-7/16	36.5	2.5	3.7
710-4B	4	18	41/34	SO	600	5.6	0.465	11.8	1-5/8	41.3	4.0	6.0
710-17	5	18	41/34	SJO	300	5.6	0.440	11.2	1-5/8	41.3	3.8	5.7
710-18	7	18	41/34	SJO	300	4.9	0.500	12.7	1-7/8	47.6	5.0	7.4
710-18B	10	18	41/34	SO	600	4.9	0.650	16.5	2-3/8	60.3	7.2	11
710-18E	15	18	41/34	SVO	300	4.7	0.575	14.6	2-1/8	54.0	6.8	10
16 AWG												
710-5	2	16	65/34	SJO	300	10	0.360	9.14	1-3/8	34.9	2.3	3.4
710-6	3	16	65/34	SJO	300	10	0.390	9.91	1-7/16	36.5	2.9	4.3
710-7	3	16	65/34	SJO	300	8	0.425	10.8	1-1/2	38.1	3.6	5.4
710-8	4	16	65/34	SO	600	10	0.470	11.9	1-13/16	46.0	3.9	5.8
710-9	4	16	65/34	SO	600	8	0.500	12.7	1-7/8	47.6	4.3	6.4
710-10	5	16	65/34	SO	600	8	0.540	13.7	2-1/8	54.0	5.5	8.2
710-20	6	16	65/34	SO	600	7	0.545	13.8	2	50.8	5.7	8.5
710-20B	8	16	65/34	SO	600	7	0.626	15.9	2-1/2	63.5	8.25	12.3
710-21	1	14	41/30	SO	600	7	0.600	15.2	2-1/4	57.2	6.7	10
	6	16	65/34									
14 AWG												
710-11	2	14	41/30	SO	600	15	0.540	13.7	2-1/8	54.0	4.6	6.8
710-12	3	14	41/30	SO	600	15	0.560	14.2	2-1/8	54.0	5.7	8.5
710-13	4	14	41/30	SO	600	12	0.605	15.4	2-1/4	57.2	6.6	9.8
710-21B	7	14	41/30	SO	600	10	0.720	18.3	2-7/8	73.0	11.0	16.4
12 AWG												
710-15	3	12	65/30	SO	600	20	0.635	16.1	2-3/8	60.3	7.3	11
710-16	4	12	65/30	SO	600	16	0.678	17.2	2-3/8	60.3	8.7	13
710-22	7	12	65/30	SO	600	16	0.775	19.7	2-5/8	66.7	13.0	19.3
10 AWG												
710-22E	4	10	104/30	SO	600	20	0.745	18.9	2-3/4	69.9	13.2	19.6

®Flexoprene is a trademark of Standard Wire & Cable Co.

California

1959 East Cashdan Street, Rancho Dominguez, CA 90220
(310) 609-1811 • (800) 326-0006 • FAX: (310) 609-1862
E-Mail: salesrd@std-wire.com

Arizona

3120 West Thomas Road, Bldg. #801, Phoenix, AZ 85017
(602) 269-2501 • (800) 325-6478 • FAX: (602) 278-7134
E-Mail: salesphx@std-wire.com



Standard Wire & Cable Co.

Retractable Cords

PVC Communication & Electronic Control Cords

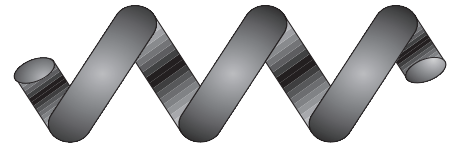

CONDUCTOR: Stranded tinned copper.
 VOLTAGE: 120 V maximum.
 CONSTRUCTION: Multi-conductor stranded, PVC jacket, length 48 in. retracted, 20 ft. extended. Also available in lengths of 12, 24, and 36 in.

Catalog No.	AWG Size	No. of Cond.	Stranding	Retracted Length		Cable O.D.		Coil O.D.		Weight	
				(in)	(mm)	(in)	(mm)	(in)	(mm)	(lbs / 48 in)	(kgs / 12.2 cm)
712-8	23	2	21/36	48	1,219	0.180	4.57	5/8	15.9	0.36	0.54
712-9	23	3	21/36	48	1,219	0.190	4.83	11/16	17.5	0.54	0.80
712-10	23	4	21/36	48	1,219	0.200	5.08	11/16	17.5	0.60	0.89
712-11	23	5	21/36	48	1,219	0.215	5.46	3/4	19.1	0.62	0.92
712-12	23	6	21/36	48	1,219	0.225	5.72	7/8	22.2	0.81	1.2
712-13	23	7	21/36	48	1,219	0.240	6.10	7/8	22.2	0.90	1.3
712-14	23	8	21/36	48	1,219	0.245	6.22	7/8	22.2	0.94	1.4
712-16	23	10	21/36	48	1,219	0.280	7.11	15/16	23.8	1.06	1.58
712-18	23	12	21/36	48	1,219	0.285	7.24	1	25.4	1.30	1.93
712-21	23	15	21/36	48	1,219	0.310	7.87	1-1/16	17.5	1.60	2.38

Retractable Cords

Heavy Duty Outdoor Use - Communication & Electronic Control Cords

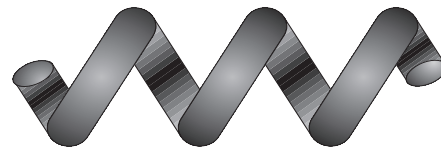

CONDUCTOR: Stranded tinned copper.
 VOLTAGE: 120 V maximum.
 CONSTRUCTION: Multi-conductor stranded, TPE jacket, length 48 in. retracted, 20 ft. extended. Also available in lengths of 12, 24, and 36 in.

Catalog No.	AWG Size	No. of Cond.	Stranding	Retracted Length		Cable O.D.		Coil O.D.		Weight	
				(in)	(mm)	(in)	(mm)	(in)	(mm)	(lbs / 48 in)	(kgs / 12.2 cm)
711-8	23	2	21/36	48	1,219	0.180	4.57	5/8	15.9	0.36	0.54
711-9	23	3	21/36	48	1,219	0.190	4.83	11/16	17.5	0.54	0.80
711-10	23	4	21/36	48	1,219	0.200	5.08	11/16	17.5	0.60	0.89
711-11	23	5	21/36	48	1,219	0.215	5.46	3/4	19.1	0.62	0.92
711-12	23	6	21/36	48	1,219	0.225	5.72	7/8	22.2	0.81	1.2
711-13	23	7	21/36	48	1,219	0.240	6.10	7/8	22.2	0.90	1.3
711-14	23	8	21/36	48	1,219	0.245	6.22	7/8	22.2	0.94	1.4
711-16	23	10	21/36	48	1,219	0.280	7.11	15/16	23.8	1.06	1.58
711-18	23	12	21/36	48	1,219	0.285	7.24	1	25.4	1.30	1.93
711-21	23	15	21/36	48	1,219	0.310	7.87	1-1/16	17.5	1.60	2.38

California

1959 East Cashdan Street, Rancho Dominguez, CA 90220
 (310) 609-1811 • (800) 326-0006 • FAX: (310) 609-1862
 E-Mail: salesrd@std-wire.com

Arizona

3120 West Thomas Road, Bldg. #801, Phoenix, AZ 85017
 (602) 269-2501 • (800) 325-6478 • FAX: (602) 278-7134
 E-Mail: salesphx@std-wire.com



Standard Wire & Cable Co.

Retractable Cords Shielded Communication Cords

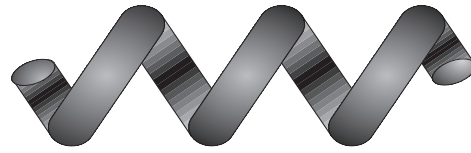

CONDUCTOR: Stranded tinned copper.
 INSULATION: Polypropylene.
 VOLTAGE: 300 V

USES: Shielded communication applications.

CONSTRUCTION: Multi-conductor, shielded and unshielded, 711 series = TPE jacketed, 712 series = PVC jacketed. Length 48 in. retracted, 20 ft. extended. Also available in lengths of 12, 24, and 36 in.

Catalog No.	AWG Size	No. of Cond.	Stranding	Retracted Length		Cable O.D.		Coil O.D.		Weight	
				(in)	(mm)	(in)	(mm)	(in)	(mm)	(lbs / 48 in)	(kgs / 12.2 cm)
711-1	23	1 (shielded)	21/36	48	1,219	0.165	4.19	5/8	15.9	0.41	0.61
711-2	23	2 (shielded)	21/36	48	1,219	0.210	5.33	3/4	19.1	0.72	1.1
711-3	23	3	21/36	48	1,219	0.205	5.21	3/4	19.1	0.69	1.0
		(1 shielded, 2 unshielded)									
711-4	23	4	21/36	48	1,219	0.230	5.84	7/8	22.2	0.96	1.4
		(2 shielded, 2 unshielded)									
712-1	23	1 (shielded)	21/36	48	1,219	0.165	4.19	5/8	15.9	0.41	0.61
712-2	23	2 (shielded)	21/36	48	1,219	0.210	5.33	3/4	19.1	0.72	1.1
712-3	23	3	21/36	48	1,219	0.205	5.21	3/4	19.1	0.69	1.0
		(1 shielded, 2 unshielded)									
712-4	23	4	21/36	48	1,219	0.230	5.84	7/8	22.2	0.96	1.4
		(2 shielded, 2 unshielded)									

Retractable Cords Test Lead

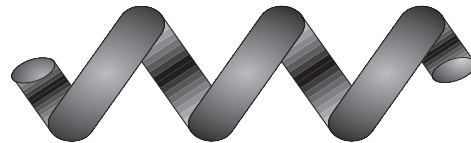

CONDUCTOR: Stranded tinned copper.
 COLOR: Black, red.
 INSULATION: TPE.
 VOLTAGE: 5 KV

CONSTRUCTION: Length 24 in. retracted, 12 ft. extended.

Catalog No.	AWG Size	No. of Cond.	Stranding	Retracted Length		Cable O.D.		Coil O.D.		Color	Weight	
				(in)	(mm)	(in)	(mm)	(in)	(mm)		(lbs / 24 in)	(kgs / 6.1 cm)
710-23	20	1	41/36	24	610	0.165	4.19	5/8	15.9	Black	0.20	0.30
710-24	20	1	41/36	24	610	0.165	4.19	5/8	15.9	Red	0.20	0.30

California

1959 East Cashdan Street, Rancho Dominguez, CA 90220
 (310) 609-1811 • (800) 326-0006 • FAX: (310) 609-1862
 E-Mail: salesrd@std-wire.com

Arizona

3120 West Thomas Road, Bldg. #801, Phoenix, AZ 85017
 (602) 269-2501 • (800) 325-6478 • FAX: (602) 278-7134
 E-Mail: salesphx@std-wire.com



Standard Wire & Cable Co.

Rubber Portable Flexible Cord Type SJ



CONDUCTOR: 2, 3, and 4 conductors of stranded bare copper. VOLTAGE: 300 V
 INSULATION: Rubber. JACKET: Black rubber.
 CONSTRUCTION: Flexible, portable power cord. Conductors cabled with fillers. Tough, resilient black rubber jacket.

Catalog No.	AWG Size	Stranding	No. of Cond.	Nominal Diameter		Weight		Ampere Capacity
				(in)	(mm)	(lbs / 1000 ft)	(kgs / km)	
702-3	18	16/30	2	0.300	7.62	54	80	10
702-5	18	16/30	3	0.330	8.38	70	104	10
702-7	18	16/30	4	0.360	9.14	92	137	7
702-9	16	26/30	2	0.325	8.26	66	98	13
702-11	16	26/30	3	0.355	9.02	89	132	13
702-13	16	26/30	4	0.395	10.0	112	167	10
702-15	14	65/30	2	0.370	9.40	87	129	18
702-17	14	65/30	3	0.390	9.91	106	158	18
702-19	14	65/30	4	0.415	10.5	144	214	15

Electric Welding Cable Flexoprene®



CONDUCTOR: Extra flexible bare copper strands. VOLTAGE: 600 V
 JACKET: Black Flexoprene®.
 CONSTRUCTION: Separator, smooth black Flexoprene® jacket. Conforms to ASTM designation D-752.

Catalog No.	AWG Size	Amps Rating	Stranding	Nominal Diameter		Weight	
				(in)	(mm)	(lbs / 1000 ft)	(kgs / km)
701-4	6	75	256/30	0.370	9.40	145	216
701-6	4	100	413/30	0.420	10.7	200	298
701-8	2	200	651/30	0.490	12.4	300	446
701-10	1	250	840/30	0.511	13.0	357	531
701-12	1/0	300	1,059/30	0.586	14.9	451	671
701-14	2/0	375	1,323/30	0.629	16.0	554	824
701-16	3/0	450	1,666/30	0.691	17.6	690	1,027
701-18	4/0	550	2,107/30	0.803	20.4	892	1,327

®Flexoprene is a trademark of Standard Wire & Cable Co.

California

1959 East Cashdan Street, Rancho Dominguez, CA 90220
 (310) 609-1811 • (800) 326-0006 • FAX: (310) 609-1862
 E-Mail: salesrd@std-wire.com

Arizona

3120 West Thomas Road, Bldg. #801, Phoenix, AZ 85017
 (602) 269-2501 • (800) 325-6478 • FAX: (602) 278-7134
 E-Mail: salesphx@std-wire.com



Standard Wire & Cable Co.

Neoprene® Portable Flexible Cord Type SO



CONDUCTOR: 2, 3, and 4 conductors of stranded bare copper.

UL LISTED: Listed.

JACKET: Resilient, black Neoprene®.

INSULATION: Rubber.

VOLTAGE: 600 V

CONSTRUCTION: Flexible, rubber insulated portable power cord, cabled with fillers, color coded.

Catalog No.	AWG Size	Stranding	No. of Cond.	Nominal Diameter		Approximate Weight		Ampere Capacity
				(in)	(mm)	(lbs / 1000 ft)	(kgs / km)	
703-2	18	16/30	2	0.345	8.76	75	112	10
703-4	18	16/30	3	0.365	9.27	87	129	10
703-6	18	16/30	4	0.390	9.91	102	152	7
703-8	16	26/30	2	0.370	9.40	78	116	13
703-10	16	26/30	3	0.390	9.91	105	156	13
703-12	16	26/30	4	0.415	10.5	120	179	10
703-14	14	41/30	2	0.500	12.7	151	225	18
703-16	14	41/30	3	0.530	13.5	176	262	18
703-18	14	41/30	4	0.570	14.5	210	312	15
703-20	12	65/30	2	0.575	14.6	201	299	25
703-22	12	65/30	3	0.600	15.2	235	350	25
703-24	12	65/30	4	0.650	16.5	292	434	20
703-26	10	104/30	2	0.625	15.9	245	365	30
703-28	10	104/30	3	0.660	16.8	307	457	30
703-30	10	104/30	4	0.710	18.0	360	536	25

Neoprene® Portable Flexible Cord Types SVO & SJO



CONDUCTOR: 2, 3, and 4 conductors of stranded bare copper.

UL LISTED: Listed.

JACKET: Resilient, black Neoprene®.

INSULATION: Rubber.

VOLTAGE: 300 V

CONSTRUCTION: Flexible, rubber insulated light-duty power cord, cabled with fillers, color coded.

Catalog No.	AWG Size	Stranding	No. of Cond.	Nominal Diameter		Approximate Weight		Ampere Capacity	Type
				(in)	(mm)	(lbs / 1000 ft)	(kgs / km)		
703-1	18	41/30	2	0.245	6.22	41	61	10	SVO
703-1A	18	41/30	3	0.255	6.48	50	74	10	SVO
703-3	18	16/30	2	0.295	7.49	56	83	10	SJO
703-5	18	16/30	3	0.320	8.13	72	107	10	SJO
703-7	18	16/30	4	0.355	9.02	96	143	7	SJO
703-9	16	26/30	2	0.320	8.13	69	103	13	SJO
703-11	16	26/30	3	0.345	8.76	92	137	13	SJO
703-13	16	26/30	4	0.385	9.78	116	173	10	SJO
703-15	14	41/30	2	0.350	8.89	92	137	18	SJO
703-17	14	41/30	3	0.380	9.65	112	167	18	SJO
703-19	14	41/30	4	0.415	10.5	136	202	15	SJO
703-20A	12	65/30	2	0.425	10.8	146	217	25	SJO
703-22A	12	65/30	3	0.450	11.4	189	281	25	SJO

Neoprene® is a trademark of the DuPont de Nemours Co.

California

1959 East Cashdan Street, Rancho Dominguez, CA 90220
(310) 609-1811 • (800) 326-0006 • FAX: (310) 609-1862
E-Mail: salesrd@std-wire.com

Arizona

3120 West Thomas Road, Bldg. #801, Phoenix, AZ 85017
(602) 269-2501 • (800) 325-6478 • FAX: (602) 278-7134
E-Mail: salesphx@std-wire.com



Standard Wire & Cable Co.

Polyvinylchloride (PVC) Insulated UL/CSA Hook-Up Wire

UL Style 1007, CSA TR-64



UL Listed



CSA Listed

CONDUCTOR: Tinned copper.*
VOLTAGE: 300 V

INSULATION: 1/64" PVC, -40° C to 80° C.

USES: Internal appliance and electronic wiring. Resistant to moisture, oil, solvents, and fungus. Passes VW-1 Vertical Flame Test.

Catalog No.	AWG Size	Stranding	Nominal Wall Thickness		Insulation Nominal O.D.		Weight	
			(in)	(mm)	(in)	(mm)	(lbs / 1000 ft)	(kgs / km)
857-1	24	Solid	1/64	0.397	0.052	1.32	2.6	3.9
857-3	22	Solid	1/64	0.397	0.059	1.50	3.6	5.4
857-5	20	Solid	1/64	0.397	0.065	1.65	5.1	7.6
857-2	24	7/32	1/64	0.397	0.056	1.42	2.8	4.2
857-4	22	7/30	1/64	0.397	0.062	1.57	3.9	5.8
857-6	20	10/30	1/64	0.397	0.071	1.80	5.0	7.4
857-8	18	16/30	1/64	0.397	0.081	2.06	7.8	12
857-10	16	26/30	1/64	0.397	0.092	2.34	10.9	16.2

UL Style 1015, CSA TEW

CONDUCTOR: Tinned copper.*
VOLTAGE: 600 V

INSULATION: 1/32" PVC, -40° C to 105° C.

USES: Internal appliance and electronic wiring. Resistant to moisture, oil, solvents, and fungus. Passes VW-1 Vertical Flame Test and is self-extinguishing.

Catalog No.	AWG Size	Stranding	Nominal Wall Thickness		Insulation Nominal O.D.		Weight	
			(in)	(mm)	(in)	(mm)	(lbs / 1000 ft)	(kgs / km)
865-2	24	7/32	1/32	0.794	0.087	2.21	5.10	7.59
865-4	22	7/30	1/32	0.794	0.094	2.39	6.30	9.37
865-6	20	10/30	1/32	0.794	0.102	2.59	7.60	11.3
865-8	18	16/30	1/32	0.794	0.113	2.87	10.1	15.0
865-10	16	26/30	1/32	0.794	0.124	3.15	14.4	21.4
865-12	14	41/30	1/32	0.794	0.138	3.51	20.1	29.9
865-14	12	65/30	1/32	0.794	0.158	4.01	29.6	44.0
865-16	10	105/30	1/32	0.794	0.184	4.67	42.2	62.8

*Available in solid or stranded and bare or tinned copper conductors.

California

1959 East Cashdan Street, Rancho Dominguez, CA 90220
(310) 609-1811 • (800) 326-0006 • FAX: (310) 609-1862
E-Mail: salesrd@std-wire.com

Arizona

3120 West Thomas Road, Bldg. #801, Phoenix, AZ 85017
(602) 269-2501 • (800) 325-6478 • FAX: (602) 278-7134
E-Mail: salesphx@std-wire.com



Standard Wire & Cable Co.

UL Style 1028, CSA TEW

CONDUCTOR: Tinned copper.*
VOLTAGE: 600 V

INSULATION: 3/64" PVC, -40° C to 105° C.

USES: Internal wiring of appliances where exposed to temperatures not exceeding 105° C. Resistant to moisture, oil, solvents, and fungus and is self-extinguishing. PVC compound to resist deformation under load. Business machine wire and computer hook-up wire for internal wiring.

Catalog No.	AWG Size	Stranding	Nominal Wall Thickness		Insulated Nominal O.D.		Weight	
			(in)	(mm)	(in)	(mm)	(lbs / 1000 ft)	(kgs / km)
869-4	22	7/30	3/64	1.19	0.124	3.15	9.40	14.0
869-6	20	10/30	3/64	1.19	0.132	3.35	11.0	16.4
869-8	18	16/30	3/64	1.19	0.144	3.66	13.9	20.7
869-10	16	26/30	3/64	1.19	0.156	3.96	18.2	27.1
869-12	14	41/30	3/64	1.19	0.174	4.42	24.3	36.2
869-14	12	65/30	3/64	1.19	0.190	4.83	33.7	50.1
869-15	10	105/30	3/64	1.19	0.215	5.46	48.0	71.4
869-18	8	133/29	3/64	1.19	0.262	6.65	77.0	115

UL Style 1061, CSA AWM

CONDUCTOR: Tinned copper.*
VOLTAGE: 300 V

INSULATION: 0.009" semirigid PVC, -40° C to 80° C.

USES: Business machine wire and computer hook-up wire for internal wiring. Resistant to moisture, oil, solvents, and fungus and is self-extinguishing. PVC compound to resist deformation under load.

Catalog No.	AWG Size	Stranding	Nominal Wall Thickness		Insulated Nominal O.D.		Weight	
			(in)	(mm)	(in)	(mm)	(lbs / 1000 ft)	(kgs / km)
875-2	26	7/34	0.009	0.23	0.038	0.97	1.4	2.1
875-4	24	7/32	0.009	0.23	0.041	1.04	2.1	3.1
875-6	22	7/30	0.009	0.23	0.048	1.22	3.1	4.6
875-8	20	7/28	0.009	0.23	0.057	1.45	4.6	6.8
875-10	20	10/30	0.009	0.23	0.058	1.47	4.4	6.5
875-14	18	16/30	0.009	0.23	0.072	1.83	5.9	8.8
875-16	16	26/30	0.009	0.23	0.084	2.13	9.1	13.5
875-1	26	Solid	0.009	0.23	0.036	0.91	1.2	1.8
875-3	24	Solid	0.009	0.23	0.040	1.02	1.9	2.8
875-5	22	Solid	0.009	0.23	0.047	1.19	3.0	4.5
875-7	20	Solid	0.009	0.23	0.056	1.42	4.5	6.7

*Available in solid or stranded and bare or tinned copper conductors.

California

1959 East Cashdan Street, Rancho Dominguez, CA 90220
(310) 609-1811 • (800) 326-0006 • FAX: (310) 609-1862
E-Mail: salesrd@std-wire.com

Arizona

3120 West Thomas Road, Bldg. #801, Phoenix, AZ 85017
(602) 269-2501 • (800) 325-6478 • FAX: (602) 278-7134
E-Mail: salesphx@std-wire.com



Standard Wire & Cable Co.

Appliance Lead Wire for High Temperature TAGT/TGGT

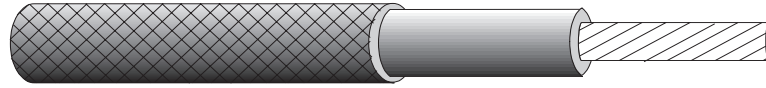

UL Listed



CSA Listed

CONDUCTOR: Stranded nickel-clad copper.
CONSTRUCTION: Fused TFE Teflon® tape, high temperature barrier and Teflon® impregnated glass braid for flame and moisture resistance.
VOLTAGE: 600 V
TEMPERATURE: 250° C.

USES: This product has excellent flexibility and stripability qualities as well as ability to resist abrasion, flame, moisture, and chemicals.

Catalog No.	AWG Size	Stranding	Nominal O.D.		Weight	
			(in)	(mm)	(lbs / 1000 ft)	(kgs / km)
1126-24	22	7/30	0.090	2.29	8	12
1126-44	20	10/30	0.100	2.54	10	15
1126-54	18	16/30	0.110	2.79	13	19
1126-71	16	26/30	0.120	3.05	18	27
1126-77	14	41/30	0.140	3.56	24	36
1126-84	12	65/30	0.160	4.06	34	51
1126-88	10	105/30	0.185	4.70	51	76
1126-90	8	133/29	0.230	5.84	65	97
1126-92	6	133/27	0.285	7.24	114	170
1126-94	4	133/25	0.340	8.64	168	250
1126-96	2	133/23	0.410	10.4	246	366
1126-98	1	259/25	0.470	11.9	320	476
1126-110	1/0	259/24	0.515	13.1	392	583
1126-120	2/0	259/23	0.570	14.5	490	729
1126-130	3/0	259/22	0.625	15.9	599	891
1126-140	4/0	259/21	0.690	17.5	746	1,110

Teflon® is a trademark of the DuPont de Nemours Co.

California

1959 East Cashdan Street, Rancho Dominguez, CA 90220
 (310) 609-1811 • (800) 326-0006 • FAX: (310) 609-1862
 E-Mail: salesrd@std-wire.com

Arizona

3120 West Thomas Road, Bldg. #801, Phoenix, AZ 85017
 (602) 269-2501 • (800) 325-6478 • FAX: (602) 278-7134
 E-Mail: salesphx@std-wire.com



Standard Wire & Cable Co.

Appliance, Fixture, Apparatus, and Motor Lead Wire SRML

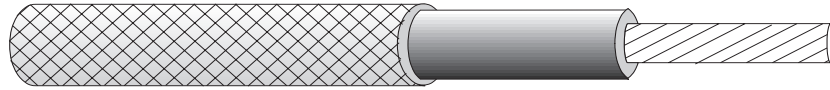

UL Listed



CSA Listed

CONDUCTOR: Stranded tinned copper. **INSULATION:** Extruded silicone rubber, glass braid, 150° C / 200° C.
VOLTAGE: 600 V

COLOR: Black, white*

PROPERTIES: Heat stable to 200° C; flexible down to -90° C; unaffected by severe thermal cycling; resists aging under heat and outdoors; unaffected by ultraviolet radiation; resists moisture and chemicals; highly flame-retardant; unaffected by ozone and corona.

USES: Ideally suited for use in areas where temperatures range from -90° C to 200° C. Can be used near ranges, furnaces, or other types of heating elements. Even soldering heat won't cause the insulation to melt or peel. Can be used where very low temperatures are a factor and won't harden or crack, even when flexed after lengthy aging and exposure.

Catalog No.	AWG Size	Stranding	Insulation Wall		Nominal O.D.		Ampacity 30° C (86° F)	Weight	
			(in)	(mm)	(in)	(mm)		(lbs / 1000 ft)	(kgs / km)
1130-9	18	16/30	2/64	0.794	0.130	3.30	24	12	18
1130-12	16	26/30	2/64	0.794	0.140	3.56	30	16	24
1130-15	14	41/30	2/64	0.794	0.160	4.06	40	22	33
1130-18	12	65/30	2/64	0.794	0.180	4.57	55	32	48
1130-21	10	105/30	3/64	1.191	0.230	5.84	75	62	92
1130-24	8	133/29	4/64	1.588	0.316	8.03	115	90	134
1130-27	6	133/27	4/64	1.588	0.362	9.19	154	140	208
1130-30	4	133/25	4/64	1.588	0.417	10.6	205	205	305
1130-33	2	133/23	4/64	1.588	0.486	12.3	280	300	446
1130-36	1	259/25	5/64	1.984	0.585	14.9	325	400	595
1130-39	1/0	259/24	5/64	1.984	0.631	16.0	385	480	714
1130-42	2/0	259/23	5/64	1.984	0.684	17.4	450	620	923
1130-45	3/0	259/22	5/64	1.984	0.743	18.9	520	760	1,131
1130-48	4/0	259/21	5/64	1.984	0.804	20.4	600	890	1,324

* Custom jacket colors available.

California

1959 East Cashdan Street, Rancho Dominguez, CA 90220
(310) 609-1811 • (800) 326-0006 • FAX: (310) 609-1862
E-Mail: salesrd@std-wire.com

Arizona

3120 West Thomas Road, Bldg. #801, Phoenix, AZ 85017
(602) 269-2501 • (800) 325-6478 • FAX: (602) 278-7134
E-Mail: salesphx@std-wire.com



Standard Wire & Cable Co.

Instrumentation Control Cable



CONDUCTORS: Stranded tinned copper. **CODED:** Numbered consecutively in black on white.
INSULATION: 0.010" semirigid, -55° C to 105° C **CABLED:** Round with fillers where needed.
 PVC Type "B" to MIL-W-16878D. **JACKET:** Black flexible PVC, -40° C to 105° C
VOLTAGE: 600 V
USES: Interconnecting cables for electronic equipment, telemetering, and instrumentation control. Resistant to flame, moisture, and many oils and chemicals.

24 AWG Conductors, 7/32 stranding (32 pF / ft between adjacent conductors)								22 AWG Conductors, 7/30 stranding (35 pF / ft between adjacent conductors)						
No. of Cond.	Catalog No.	Jacket Thickness		Cable O.D.		Weight		Catalog No.	Jacket Thickness		Cable O.D.		Weight	
		(in)	(mm)	(in)	(mm)	(lbs / 1000 ft)	(kgs / km)		(in)	(mm)	(in)	(mm)	(lbs / 1000 ft)	(kgs / km)
2	5001	0.025	0.635	0.143	3.63	11	16	5101	0.025	0.635	0.155	3.94	12	18
3	5002	0.025	0.635	0.150	3.81	13	19	5102	0.025	0.635	0.163	4.14	16	24
4	5003	0.025	0.635	0.162	4.11	16	24	5103	0.025	0.635	0.176	4.47	19	28
5	5004	0.025	0.635	0.174	4.42	18	27	5104	0.025	0.635	0.190	4.83	23	34
6	5005	0.025	0.635	0.187	4.75	22	33	5105	0.025	0.635	0.205	5.21	28	42
7	5006	0.025	0.635	0.187	4.75	24	36	5106	0.025	0.635	0.205	5.21	30	45
8	5007	0.025	0.635	0.201	5.11	26	39	5107	0.025	0.635	0.221	5.61	33	49
9	5008	0.025	0.635	0.214	5.44	30	45	5108	0.025	0.635	0.236	5.99	39	58
10	5009	0.025	0.635	0.231	5.87	32	48	5109	0.025	0.635	0.255	6.48	41	61
11	5010	0.025	0.635	0.231	5.87	35	52	5110	0.025	0.635	0.255	6.48	44	65
12	5011	0.025	0.635	0.238	6.05	37	55	5111	0.025	0.635	0.263	6.68	47	70
13	5012	0.025	0.635	0.249	6.32	40	60	5112	0.025	0.635	0.276	7.01	52	77
14	5013	0.025	0.635	0.249	6.32	42	62	5113	0.025	0.635	0.276	7.01	54	80
15	5014	0.025	0.635	0.263	6.68	46	68	5114	0.025	0.635	0.291	7.39	59	88
20	5015	0.025	0.635	0.289	7.34	58	86	5115	0.030	0.762	0.331	8.41	77	115
25	5016	0.030	0.762	0.329	8.36	74	110	5116	0.030	0.762	0.365	9.27	96	143
30	5017	0.030	0.762	0.347	8.81	84	125	5117	0.035	0.889	0.396	10.1	113	168
35	5018	0.035	0.889	0.383	9.73	101	150	5118	0.035	0.889	0.425	10.8	132	196
40	5019	0.035	0.889	0.397	10.1	111	165	5119	0.040	1.02	0.451	11.5	150	223
45	5020	0.040	1.02	0.437	11.1	135	201	5120	0.040	1.02	0.485	12.3	172	256
50	5021	0.040	1.02	0.455	11.6	146	217	5121	0.045	1.14	0.516	13.1	191	284
60	5022	0.040	1.02	0.481	12.2	169	251	5122	0.045	1.14	0.545	13.8	222	330
70	5023	0.045	1.14	0.535	13.6	199	296	5123	0.050	1.27	0.605	15.4	261	388
80	5024	0.050	1.27	0.564	14.3	222	330	5124	0.050	1.27	0.627	15.9	292	434
90	5025	0.050	1.27	0.589	15.0	247	368	5125	0.050	1.27	0.655	16.6	326	485
100	5026	0.050	1.27	0.633	16.1	273	406	5126	0.055	1.40	0.715	18.2	368	548
110	5027	0.050	1.27	0.652	16.6	299	445	5127	0.055	1.40	0.737	18.7	403	600
120	5028	0.050	1.27	0.665	16.9	318	473	5128	0.055	1.40	0.751	19.1	430	640

All dimensions are nominal.

California

1959 East Cashdan Street, Rancho Dominguez, CA 90220
 (310) 609-1811 • (800) 326-0006 • FAX: (310) 609-1862
 E-Mail: salesrd@std-wire.com

Arizona

3120 West Thomas Road, Bldg. #801, Phoenix, AZ 85017
 (602) 269-2501 • (800) 325-6478 • FAX: (602) 278-7134
 E-Mail: salesphx@std-wire.com



Standard Wire & Cable Co.

Instrumentation Control Cable



CONDUCTORS: Stranded tinned copper. **CODED:** Numbered consecutively in black on white.
INSULATION: 0.010" semirigid, -55° C to 105° C
 PVC Type "B" to MIL-W-16878D. **CABLED:** Round with fillers where needed.
VOLTAGE: 600 V **JACKET:** Black flexible PVC, -40° C to 105° C.
USES: Interconnecting cables for electronic equipment, telemetering, and instrumentation control. Resistant to flame, moisture, and many oils and chemicals.

20 AWG Conductor, 7/28 stranding (38 pF / ft between adjacent conductors)								18 AWG Conductor, 7/26 stranding (41 pF / ft between adjacent conductors)						
No. of Cond.	Catalog No.	Jacket Thickness		Cable O.D.		Weight		Catalog No.	Jacket Thickness		Cable O.D.		Weight	
		(in)	(mm)	(in)	(mm)	(lbs / 1000 ft)	(kgs / km)		(in)	(mm)	(in)	(mm)	(lbs / 1000 ft)	(kgs / km)
2	5201	0.025	0.635	0.171	4.34	16	24	5301	0.025	0.635	0.191	4.85	22	33
3	5202	0.025	0.635	0.181	4.60	22	33	5302	0.025	0.635	0.202	5.13	29	43
4	5203	0.025	0.635	0.196	4.98	27	40	5303	0.025	0.635	0.220	5.59	37	55
5	5204	0.025	0.635	0.211	5.36	33	49	5304	0.025	0.635	0.239	6.07	46	68
6	5205	0.025	0.635	0.229	5.82	39	58	5305	0.025	0.635	0.259	6.58	55	82
7	5206	0.025	0.635	0.229	5.82	42	62	5306	0.025	0.635	0.259	6.58	60	89
8	5207	0.025	0.635	0.247	6.27	48	71	5307	0.025	0.635	0.280	7.11	68	101
9	5208	0.025	0.635	0.265	6.73	55	82	5308	0.025	0.635	0.301	7.65	79	118
10	5209	0.025	0.635	0.287	7.29	59	88	5309	0.030	0.762	0.337	8.56	84	125
11	5210	0.025	0.635	0.287	7.29	65	97	5310	0.030	0.762	0.337	8.56	97	144
12	5211	0.025	0.635	0.297	7.54	69	103	5311	0.030	0.762	0.348	8.84	101	150
13	5212	0.030	0.762	0.321	8.15	78	116	5312	0.030	0.762	0.365	9.27	112	167
14	5213	0.030	0.762	0.321	8.15	82	122	5313	0.030	0.762	0.365	9.27	116	173
15	5214	0.030	0.762	0.339	8.61	89	132	5314	0.035	0.889	0.395	10.0	131	195
20	5215	0.035	0.889	0.383	9.73	118	176	5315	0.040	1.02	0.446	11.3	169	251
25	5216	0.035	0.889	0.423	10.7	145	216	5316	0.040	1.02	0.493	12.5	206	307
30	5217	0.040	1.02	0.457	11.6	171	254	5317	0.045	1.14	0.531	13.5	250	372
35	5218	0.045	1.14	0.501	12.7	204	304	5318	0.050	1.27	0.581	14.8	298	443
40	5219	0.045	1.14	0.510	13.0	226	336	5319	0.050	1.27	0.602	15.3	330	491
45	5220	0.050	1.27	0.569	14.5	262	390	5320	0.050	1.27	0.649	16.5	377	561
50	5221	0.050	1.27	0.593	15.1	286	426	5321	0.050	1.27	0.677	17.2	411	612
60	5222	0.050	1.27	0.627	15.9	334	497	5322	0.055	1.40	0.727	18.5	489	728
70	5223	0.055	1.40	0.695	17.7	392	583	5323	0.060	1.52	0.805	20.4	571	850
80	5224	0.055	1.40	0.720	18.3	440	655	5324	0.060	1.52	0.834	21.2	643	957
90	5225	0.055	1.40	0.753	19.1	491	731	5325	0.060	1.52	0.873	22.2	719	1,070
100	5226	0.060	1.52	0.821	20.9	553	823	5326	0.065	1.65	0.951	24.2	808	1,202
110	5227	0.060	1.52	0.845	21.5	555	826	5327	0.065	1.65	0.980	24.9	885	1,317
120	5228	0.060	1.52	0.863	21.9	648	964	5328	0.065	1.65	1.000	25.4	949	1,412

All dimensions are nominal.

California

1959 East Cashdan Street, Rancho Dominguez, CA 90220
 (310) 609-1811 • (800) 326-0006 • FAX: (310) 609-1862
 E-Mail: salesrd@std-wire.com

Arizona

3120 West Thomas Road, Bldg. #801, Phoenix, AZ 85017
 (602) 269-2501 • (800) 325-6478 • FAX: (602) 278-7134
 E-Mail: salesphx@std-wire.com



Standard Wire & Cable Co.

Instrumentation Control Cable with Overall Shield



CONDUCTORS: Stranded tinned copper. CODED: Numbered consecutively in black on white.
 INSULATION: 0.010" semirigid, -55° C to 105° C CABLED: Round with fillers where needed.
 PVC Type "B" to MIL-W-16878D. SHIELD: Braided tinned copper, 80% coverage.
 VOLTAGE: 600 V JACKET: Black flexible PVC, -40° C to 105° C.
 USES: Interconnecting cables for electronic equipment, telemetering, and instrumentation control. Resistant to flame, moisture, and many oils and chemicals.

No. of Cond.	24 AWG Conductor, 7/32 stranding (32 pF / ft between adjacent conductors)							22 AWG Conductor, 7/30 stranding (35 pF / ft between adjacent conductors)						
	Catalog No.	Jacket Thickness (in) (mm)		Cable O.D. (in) (mm)		Weight (lbs / 1000 ft) (kgs / km)		Catalog No.	Jacket Thickness (in) (mm)		Cable O.D. (in) (mm)		Weight (lbs / 1000 ft) (kgs / km)	
2	5001-S	0.025	0.635	0.166	4.22	19	28	5101-S	0.025	0.635	0.178	4.52	20	30
3	5002-S	0.025	0.635	0.173	4.39	22	33	5102-S	0.025	0.635	0.186	4.72	25	37
4	5003-S	0.025	0.635	0.185	4.70	25	37	5103-S	0.025	0.635	0.199	5.05	29	43
5	5004-S	0.025	0.635	0.197	5.00	29	43	5104-S	0.025	0.635	0.213	5.41	34	51
6	5005-S	0.025	0.635	0.210	5.33	33	49	5105-S	0.025	0.635	0.228	5.79	40	60
7	5006-S	0.025	0.635	0.210	5.33	35	52	5106-S	0.025	0.635	0.228	5.79	42	62
8	5007-S	0.025	0.635	0.224	5.69	39	58	5107-S	0.025	0.635	0.244	6.20	48	71
9	5008-S	0.025	0.635	0.237	6.02	46	68	5108-S	0.025	0.635	0.259	6.58	55	82
10	5009-S	0.025	0.635	0.254	6.45	48	71	5109-S	0.025	0.635	0.278	7.06	57	85
11	5010-S	0.025	0.635	0.254	6.45	50	74	5110-S	0.025	0.635	0.278	7.06	62	92
12	5011-S	0.025	0.635	0.261	6.63	52	77	5111-S	0.025	0.635	0.286	7.26	64	95
13	5012-S	0.025	0.635	0.272	6.91	57	85	5112-S	0.025	0.635	0.299	7.59	68	101
14	5013-S	0.025	0.635	0.272	6.91	59	88	5113-S	0.025	0.635	0.299	7.59	70	104
15	5014-S	0.025	0.635	0.286	7.26	63	94	5114-S	0.025	0.635	0.314	7.98	84	125
20	5015-S	0.025	0.635	0.312	7.92	79	118	5115-S	0.030	0.762	0.361	9.17	100	149
25	5016-S	0.030	0.762	0.359	9.12	82	122	5116-S	0.030	0.762	0.395	10.0	120	178
30	5017-S	0.030	0.762	0.377	9.58	107	159	5117-S	0.035	0.889	0.426	10.8	140	209
35	5018-S	0.035	0.889	0.413	10.5	128	191	5118-S	0.035	0.889	0.455	11.6	159	237
40	5019-S	0.035	0.889	0.427	10.8	138	205	5119-S	0.040	1.02	0.481	12.2	183	272
45	5020-S	0.040	1.02	0.467	11.9	167	248	5120-S	0.040	1.02	0.515	13.1	203	302
50	5021-S	0.040	1.02	0.485	12.3	177	264	5121-S	0.045	1.14	0.546	13.9	224	334
60	5022-S	0.040	1.02	0.511	13.0	204	304	5122-S	0.045	1.14	0.575	14.6	259	385
70	5023-S	0.045	1.14	0.565	14.4	235	350	5123-S	0.050	1.27	0.635	16.1	302	449
80	5024-S	0.050	1.27	0.594	15.1	260	387	5124-S	0.050	1.27	0.657	16.7	336	500
90	5025-S	0.050	1.27	0.619	15.7	289	431	5125-S	0.050	1.27	0.685	17.4	371	552
100	5026-S	0.050	1.27	0.663	16.8	317	472	5126-S	0.055	1.40	0.745	18.9	417	620
110	5027-S	0.050	1.27	0.682	17.3	344	511	5127-S	0.055	1.40	0.767	19.5	450	670
120	5028-S	0.050	1.27	0.695	17.7	364	541	5128-S	0.055	1.40	0.781	19.8	486	723

All dimensions are nominal.

California

1959 East Cashdan Street, Rancho Dominguez, CA 90220
 (310) 609-1811 • (800) 326-0006 • FAX: (310) 609-1862
 E-Mail: salesrd@std-wire.com

Arizona

3120 West Thomas Road, Bldg. #801, Phoenix, AZ 85017
 (602) 269-2501 • (800) 325-6478 • FAX: (602) 278-7134
 E-Mail: salesphx@std-wire.com



Standard Wire & Cable Co.

Instrumentation Control Cable with Overall Shield



CONDUCTORS: Stranded tinned copper. **CODED:** Numbered consecutively in black on white.
INSULATION: 0.010" semirigid, -55° C to 105° C **CABLED:** Round with fillers where needed.
 PVC Type "B" to MIL-W-16878D. **SHIELD:** Braided tinned copper, 80% coverage.
VOLTAGE: 600 V **JACKET:** Black flexible PVC, -40° C to 105° C
USES: Interconnecting cables for electronic equipment, telemetering, and instrumentation control. Resistant to flame, moisture, and many oils and chemicals.

		20 AWG Conductor, 7/28 stranding (38 pF / ft between adjacent conductors)						18 AWG Conductor, 7/26 stranding (41 pF / ft between adjacent conductors)						
No. of Cond.	Catalog No.	Jacket Thickness		Cable O.D.		Weight		Catalog No.	Jacket Thickness		Cable O.D.		Weight	
		(in)	(mm)	(in)	(mm)	(lbs / 1000 ft)	(kgs / km)		(in)	(mm)	(in)	(mm)	(lbs / 1000 ft)	(kgs / km)
2	5201-S	0.025	0.635	0.194	4.93	28	42	5301-S	0.025	0.635	0.214	5.44	35	52
3	5202-S	0.025	0.635	0.204	5.18	34	51	5302-S	0.025	0.635	0.225	5.72	44	65
4	5203-S	0.025	0.635	0.219	5.56	39	58	5303-S	0.025	0.635	0.243	6.17	53	79
5	5204-S	0.025	0.635	0.234	5.94	47	70	5304-S	0.025	0.635	0.262	6.65	62	92
6	5205-S	0.025	0.635	0.252	6.40	54	80	5305-S	0.025	0.635	0.282	7.16	72	107
7	5206-S	0.025	0.635	0.252	6.40	60	89	5306-S	0.025	0.635	0.282	7.16	80	119
8	5207-S	0.025	0.635	0.270	6.86	66	98	5307-S	0.025	0.635	0.303	7.70	88	131
9	5208-S	0.025	0.635	0.288	7.32	76	113	5308-S	0.025	0.635	0.324	8.23	100	149
10	5209-S	0.025	0.635	0.310	7.87	80	119	5309-S	0.030	0.762	0.367	9.32	111	165
11	5210-S	0.025	0.635	0.310	7.87	87	129	5310-S	0.030	0.762	0.367	9.32	119	177
12	5211-S	0.025	0.635	0.320	8.13	92	137	5311-S	0.030	0.762	0.378	9.60	126	187
13	5212-S	0.030	0.762	0.351	8.92	101	150	5312-S	0.030	0.762	0.395	10.0	135	201
14	5213-S	0.030	0.762	0.351	8.92	105	157	5313-S	0.030	0.762	0.395	10.0	142	212
15	5214-S	0.030	0.762	0.369	9.37	113	168	5314-S	0.035	0.889	0.425	10.8	156	232
20	5215-S	0.035	0.889	0.413	10.5	143	213	5315-S	0.040	1.02	0.476	12.1	201	299
25	5216-S	0.035	0.889	0.453	11.5	176	262	5316-S	0.040	1.02	0.523	13.3	245	364
30	5217-S	0.040	1.02	0.487	12.4	205	306	5317-S	0.045	1.14	0.561	14.2	288	428
35	5218-S	0.045	1.14	0.531	13.5	237	353	5318-S	0.050	1.27	0.611	15.5	335	498
40	5219-S	0.045	1.14	0.540	13.7	263	392	5319-S	0.050	1.27	0.632	16.1	373	555
45	5220-S	0.050	1.27	0.599	15.2	301	447	5320-S	0.050	1.27	0.679	17.2	418	622
50	5221-S	0.050	1.27	0.623	15.8	329	489	5321-S	0.050	1.27	0.707	18.0	456	679
60	5222-S	0.050	1.27	0.657	16.7	379	563	5322-S	0.055	1.40	0.757	19.2	539	803
70	5223-S	0.055	1.40	0.725	18.4	442	658	5323-S	0.060	1.52	0.835	21.2	630	937
80	5224-S	0.055	1.40	0.750	19.1	496	738	5324-S	0.060	1.52	0.864	21.9	705	1,048
90	5225-S	0.055	1.40	0.783	19.9	546	812	5325-S	0.060	1.52	0.903	22.9	781	1,163
100	5226-S	0.060	1.52	0.851	21.6	611	909	5326-S	0.065	1.65	0.981	24.9	874	1,300
110	5227-S	0.060	1.52	0.875	22.2	666	991	5327-S	0.065	1.65	1.010	25.65	949	1,412
120	5228-S	0.060	1.52	0.893	22.7	716	1,065	5328-S	0.065	1.65	1.030	26.16	1,022	1,521

All dimensions are nominal.

California

1959 East Cashdan Street, Rancho Dominguez, CA 90220
 (310) 609-1811 • (800) 326-0006 • FAX: (310) 609-1862
 E-Mail: salesrd@std-wire.com

Arizona

3120 West Thomas Road, Bldg. #801, Phoenix, AZ 85017
 (602) 269-2501 • (800) 325-6478 • FAX: (602) 278-7134
 E-Mail: salesphx@std-wire.com



Standard Wire & Cable Co.

Multiple Pair Control Cable, Each Pair Shielded



CONDUCTORS: Stranded tinned soft copper. **JACKET:** Black flexible PVC, -40° C to 80° C.
INSULATION: High dielectric strength, low loss polyethylene. 22 and 20 AWG with 0.015" nominal wall. **COLOR CODE:** See color code chart No. 4 on page 33.

CONSTRUCTION: Formed by twisting 2 conductors with an uninsulated stranded tinned copper drain wire (for terminating shield). The 22 and 20 AWG pairs utilize a 22 AWG drain wire. Each pair is shielded with Mylar® supported aluminum foil, spirally wrapped. The aluminum foil is 0.00035" thick and the Mylar® supporting film is 0.0005" thick. Cabled round with fillers where needed with 0.001" thick binder. Temperature rating -40° C to 80° C. Resistant to flame, moisture, and many oils and chemicals.

USES: Monitoring, data recording, and conveyance of information, such as telemetering, communication, temperature, pressure, and flow.

		22 AWG Pairs, 7/30 stranding (48 pF / ft between one conductor & other conductor tied to shield; 25 pF / ft mutual)						20 AWG Pairs, 7/28 stranding (56 pF / ft between one conductor & other conductor tied to shield; 30 pF / ft mutual)						
No. of Pairs	Catalog No.	Jacket Thickness		Cable O.D.		Weight		Catalog No.	Jacket Thickness		Cable O.D.		Weight	
		(in)	(mm)	(in)	(mm)	(lbs / 1000 ft)	(kgs / km)		(in)	(mm)	(in)	(mm)	(lbs / 1000 ft)	(kgs / km)
2	5401-S	0.030	0.762	0.297	7.53	32	48	5501-S	0.030	0.762	0.315	8.00	45	67
3	5402-S	0.030	0.762	0.315	8.00	41	61	5502-S	0.030	0.762	0.335	8.51	59	88
4	5403-S	0.030	0.762	0.345	8.76	51	76	5503-S	0.030	0.762	0.365	9.27	75	112
5	5404-S	0.035	0.889	0.385	9.78	65	97	5504-S	0.035	0.889	0.410	10.4	95	141
6	5405-S	0.035	0.889	0.420	10.7	76	113	5505-S	0.040	1.02	0.460	11.7	115	171
9	5406-S	0.045	1.14	0.510	13.0	119	177	5506-S	0.045	1.14	0.545	13.8	172	256
12	5407-S	0.050	1.27	0.580	14.7	152	226	5507-S	0.050	1.27	0.625	15.9	221	329
15	5408-S	0.050	1.27	0.645	16.4	183	272	5508-S	0.055	1.40	0.700	17.8	276	411
19	5409-S	0.050	1.27	0.675	17.1	220	327	5509-S	0.055	1.40	0.735	18.7	335	498
27	5410-S	0.060	1.52	0.830	21.1	315	469	5510-S	0.060	1.52	0.890	22.6	469	698
50	5411-S	0.070	1.78	1.105	28.07	561	835	5511-S	0.075	1.91	1.200	30.48	854	1,271

Mylar® is a trademark of the DuPont de Nemours Co.

California

1959 East Cashdan Street, Rancho Dominguez, CA 90220
 (310) 609-1811 • (800) 326-0006 • FAX: (310) 609-1862
 E-Mail: salesrd@std-wire.com

Arizona

3120 West Thomas Road, Bldg. #801, Phoenix, AZ 85017
 (602) 269-2501 • (800) 325-6478 • FAX: (602) 278-7134
 E-Mail: salesphx@std-wire.com



Standard Wire & Cable Co.

Multiple Pair Control Cable, Each Pair Shielded



CONDUCTORS: Stranded tinned soft copper. **JACKET:** Black flexible PVC, -40° C to 80° C.
INSULATION: High dielectric strength, low loss polyethylene. 18 and 16 AWG with 0.020" nominal wall. **COLOR CODE:** See color code chart No. 4 on page 33.

CONSTRUCTION: Formed by twisting 2 conductors with an uninsulated stranded tinned copper drain wire (for terminating shield). The 18 and 16 AWG pairs utilize a 20 AWG drain wire. Each pair is shielded with Mylar® supported aluminum foil, spirally wrapped. The aluminum foil is 0.00035" thick and the Mylar® supporting film is 0.0005" thick. Cabled round with fillers where needed with 0.001" thick binder. Temperature rating -40° C to 80° C. Resistant to flame, moisture, and many oils and chemicals.

USES: Monitoring, data recording, and conveyance of information, such as telemetering, communication, temperature, pressure, and flow.

		18 AWG Pairs, 16/30 stranding (53 pF / ft between one conductor & other conductor tied to shield; 28 pF / ft mutual)						16 AWG Pairs, 26/30 stranding (67 pF / ft between one conductor & other conductor tied to shield; 35 pF / ft mutual)						
No. of Pairs	Catalog No.	Jacket Thickness		Cable O.D.		Weight		Catalog No.	Jacket Thickness		Cable O.D.		Weight	
		(in)	(mm)	(in)	(mm)	(lbs / 1000 ft)	(kgs / km)		(in)	(mm)	(in)	(mm)	(lbs / 1000 ft)	(kgs / km)
2	5601-S	0.035	0.889	0.390	9.91	64	95	5701-S	0.040	1.02	0.450	11.4	92	137
3	5602-S	0.035	0.889	0.415	10.5	86	128	5702-S	0.040	1.02	0.480	12.2	124	185
4	5603-S	0.040	1.02	0.465	11.8	114	170	5703-S	0.045	1.14	0.535	13.6	164	244
5	5604-S	0.045	1.14	0.520	13.2	142	211	5704-S	0.050	1.27	0.600	15.2	204	304
6	5605-S	0.050	1.27	0.575	14.6	172	256	5705-S	0.050	1.27	0.655	16.6	240	357
9	5606-S	0.050	1.27	0.670	17.0	248	369	5706-S	0.055	1.40	0.775	19.7	356	530
12	5607-S	0.055	1.40	0.765	19.4	318	473	5707-S	0.060	1.52	0.885	22.5	459	683
15	5608-S	0.060	1.52	0.860	21.8	396	589	5708-S	0.065	1.65	0.995	25.3	571	850
19	5609-S	0.065	1.65	0.915	23.2	491	731	5709-S	0.070	1.78	1.06	26.8	714	1,062
27	5610-S	0.070	1.78	1.105	28.07	687	1,022	5710-S	0.080	2.03	1.29	32.6	1,005	1,495
50	5611-S	0.080	2.03	1.480	37.59	1,227	1,826	5711-S	0.090	2.29	1.72	43.6	1,808	2,690

Mylar® is a trademark of the DuPont de Nemours Co.

California

1959 East Cashdan Street, Rancho Dominguez, CA 90220
 (310) 609-1811 • (800) 326-0006 • FAX: (310) 609-1862
 E-Mail: salesrd@std-wire.com

Arizona

3120 West Thomas Road, Bldg. #801, Phoenix, AZ 85017
 (602) 269-2501 • (800) 325-6478 • FAX: (602) 278-7134
 E-Mail: salesphx@std-wire.com



Standard Wire & Cable Co.

Tinned Copper Flexible Braid QQ-B-575



CONDUCTOR: Fine drawn tinned copper.
CONSTRUCTION: Flexible braid in tubular form (also available flattened).
USES: Used as shielding over electrical conductors or connections to motor brushes, controller contacts, and grounding bonds.

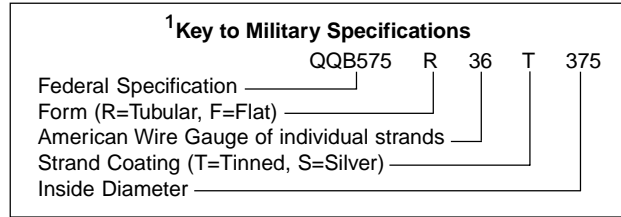

Catalog No.	Mil. Spec. ¹	Approx. AWG	Nominal I.D.		Total No. Ends	Gauge of Wires	Construction	Weight	
			(in)	(mm)				(# ft / lb)	(# m / kg)
300-5	N/A	24	1/32	0.79	16	36	16 x 1 x 36	800	111
300-8	QQB575R36T0031	22	1/32	0.79	24	36	24 x 1 x 36	500	69.1
300-12	QQB575R34T0062	19	1/16	1.59	32	34	16 x 2 x 34	233	32.2
300-13	QQB575R36T0062	19	1/16	1.59	48	36	24 x 2 x 36	250	34.6
300-15	QQB575R36T0078	18	5/64	1.98	72	36	24 x 3 x 36	165	22.8
300-18	QQB575R34T0109	16	7/64	2.78	64	34	16 x 4 x 34	114	15.8
300-19	QQB575R36T0109	16	7/64	2.78	96	36	24 x 4 x 36	122	16.9
300-19B	QQB575R34T0125	16	1/8	3.18	72	34	24 x 3 x 34	109	15.1
300-20	QQB575R36T0125	15	1/8	3.18	120	36	24 x 5 x 36	97.0	13.4
300-23	QQB575R36T0171	14	11/64	4.37	168	36	24 x 7 x 36	69.9	9.66
300-23B	QQB575R34T0171	13	11/64	4.37	120	34	24 x 5 x 34	64.1	8.86
300-26	QQB575R36T0156	12	5/32	3.97	240	36	24 x 10 x 36	47.8	6.61
300-28	QQB575R36T0203	11	13/64	5.16	312	36	24 x 13 x 36	38.0	5.25
300-28B	QQB575R34T0203	11	13/64	5.16	192	34	24 x 8 x 34	35.8	4.95
300-30	N/A	11	1/4	6.35	344	36	16 x 14 x 36 8 x 15 x 36	30.4	4.20
300-31	QQB575R36T0250	10	1/4	6.35	384	36	24 x 16 x 36	29.0	4.01
300-33	QQB575R34T0375	10	3/8	9.53	240	34	48 x 5 x 34	30.6	4.23
300-35	QQB575R36T0375	10	3/8	9.53	384	36	48 x 8 x 36	29.0	4.01
300-38	QQB575R34T0500	9	1/2	12.7	336	34	48 x 7 x 34	21.0	2.90
300-40	QQB575R36T0500	9	1/2	12.7	528	36	48 x 11 x 36	21.0	2.90
300-42	QQB575R30T0375	8	3/8	9.53	168	30	24 x 7 x 30	17.5	2.42
300-44	QQB575R36T0781	7	25/32	19.8	864	36	48 x 18 x 36	13.6	1.88
300-46	QQB575R30T0437	6	7/16	11.1	240	30	24 x 10 x 30	12.5	1.73
300-48	QQB575R30T0500	6	1/2	12.7	360	30	24 x 15 x 30	8.5	1.2
300-50	N/A	5	3/4	19.1	288	30	48 x 6 x 30	9.7	1.3
300-51	QQB575R30T0875	5	7/8	22.2	336	30	48 x 7 x 30	8.5	1.2
300-52	QQB575R30T1000	4	1	25.4	384	30	48 x 8 x 30	7.4	1.0
300-53	QQB575R30T1125	4	1-1/8	28.6	432	30	48 x 9 x 30	6.7	0.93
300-55	QQB575R30T0562	3	9/16	14.3	480	30	48 x 10 x 30	6.6	0.91
300-56	QQB575R30T1375	3	1-3/8	34.9	528	30	48 x 11 x 30	5.6	0.77
300-57	QQB575R30T1500	3	1-1/2	38.1	576	30	48 x 12 x 30	5.1	0.71
300-59	QQB575R30T2000	2	2	50.8	672	30	48 x 14 x 30	4.4	0.61
300-61	QQB575R30T0656	1	2-1/32	51.6	768	30	48 x 16 x 30	3.9	0.54

California

1959 East Cashdan Street, Rancho Dominguez, CA 90220
 (310) 609-1811 • (800) 326-0006 • FAX: (310) 609-1862
 E-Mail: salesrd@std-wire.com

Arizona

3120 West Thomas Road, Bldg. #801, Phoenix, AZ 85017
 (602) 269-2501 • (800) 325-6478 • FAX: (602) 278-7134
 E-Mail: salesphx@std-wire.com



Standard Wire & Cable Co.

Bare Solid Soft Drawn Copper Wire QQ-W-343



CONDUCTOR: Electrolytic copper, fully annealed, smooth, bright finish.
 USES: Conforms to Mil. Spec. QQ-W-343 & MIL-W-3861 Type S.

Catalog No.	Mil. Spec.	AWG Size	Diameter		Maximum Tensile Strength		Breaking Strength		Maximum DC Resistance		Weight	
			(in)	(mm)	(lbs / sq in)	(kgs / sq cm)	(max. lbs)	(max. kgs)	(ohms / 1000 ft)*	(ohms / km)*	(lbs / 1000 ft)	(kgs / km)
303-7	QQW343S30S1B	30	0.010	0.254	40,000	2,812	3.16	1.43	103	339	0.304	0.453
303-8	QQW343S28S1B	28	0.013	0.320	40,000	2,812	5.02	2.28	64.9	213	0.484	0.720
303-9	QQW343S26S1B	26	0.016	0.404	40,000	2,812	7.98	3.62	40.8	134	0.769	1.14
303-10	QQW343S24S1B	24	0.020	0.511	40,000	2,812	12.7	5.76	25.7	84.2	1.22	1.82
303-11	QQW343S22S1B	22	0.025	0.643	38,500	2,707	19.4	8.81	16.1	53.0	1.95	2.89
303-12	QQW343S20S1B	20	0.032	0.813	38,500	2,707	30.9	14.0	10.2	33.3	3.09	4.60
303-13	QQW343S18S1B	18	0.040	1.02	38,500	2,707	49.1	22.3	6.39	20.9	4.92	7.32
303-14	QQW343S16S1B	16	0.051	1.29	38,500	2,707	78.1	35.4	4.02	13.2	7.82	11.6
303-15	QQW343S14S1B	14	0.064	1.63	38,500	2,707	124	56.3	2.53	8.28	12.4	18.5
303-16	QQW343S12S1B	12	0.081	2.05	38,500	2,707	198	89.6	1.59	5.21	19.8	29.4
303-17	QQW343S10S1B	10	0.102	2.59	38,500	2,707	314	142	1.00	3.28	31.4	46.8
303-18	QQW343S08S1B	8	0.129	3.26	37,000	2,601	480	218	0.63	2.1	50.0	74.4

Tinned Solid Soft Drawn Copper Wire QQ-W-343



CONDUCTOR: Uniform thickness of pure tin coating, fully annealed, smooth, bright finish.
 USES: Conforms to Mil. Spec. QQ-W-343 & MIL-W-3861 Type S.

Catalog No.	Mil. Spec.	AWG Size	Diameter		Maximum Tensile Strength		Breaking Strength		Maximum DC Resistance		Weight	
			(in)	(mm)	(lbs / sq in)	(kgs / sq cm)	(max. lbs)	(max. kgs)	(ohms / 1000 ft)*	(ohms / km)*	(lbs / 1000 ft)	(kgs / km)
302-3	QQW343S38S1T	38	0.004	0.102	40,000	2,812	0.494	0.224	708	2,323	0.048	0.072
302-4	QQW343S36S1T	36	0.005	0.127	40,000	2,812	0.785	0.356	445	1,461	0.076	0.113
302-5	QQW343S34S1T	34	0.006	0.160	40,000	2,812	1.25	0.567	280	919	0.120	0.179
302-6	QQW343S32S1T	32	0.008	0.203	40,000	2,812	1.99	0.901	176	578	0.191	0.285
302-7	QQW343S30S1T	30	0.010	0.254	40,000	2,812	3.16	1.43	111	364	0.304	0.453
302-8	QQW343S28S1T	28	0.013	0.320	39,000	2,742	5.02	2.28	68.9	226	0.484	0.720
302-9	QQW343S26S1T	26	0.016	0.404	39,000	2,742	7.98	3.62	43.3	142	0.769	1.14
302-10	QQW343S24S1T	24	0.020	0.511	39,000	2,742	12.7	5.76	27.3	89.4	1.22	1.82
302-11	QQW343S22S1T	22	0.025	0.643	38,500	2,707	19.4	8.81	17.0	55.7	1.95	2.89
302-12	QQW343S20S1T	20	0.032	0.813	38,500	2,707	30.9	14.0	10.6	34.6	3.09	4.60
302-13	QQW343S18S1T	18	0.040	1.02	38,500	2,707	49.1	22.3	6.64	21.8	4.92	7.32
302-14	QQW343S16S1T	16	0.051	1.29	38,500	2,707	78.1	35.4	4.18	13.7	7.82	11.6
302-15	QQW343S14S1T	14	0.064	1.63	38,500	2,707	124	56.3	2.63	8.62	12.4	18.5
302-16	QQW343S12S1T	12	0.081	2.05	38,500	2,707	198	89.6	1.65	5.42	19.8	29.4
302-17	QQW343S10S1T	10	0.102	2.59	38,500	2,707	314	142	1.04	3.41	31.4	46.8
302-18	QQW343S08S1T	8	0.129	3.26	37,000	2,601	480	218	0.646	2.12	50.0	74.4
302-19	QQW343S06S1T	6	0.162	4.11	37,000	2,601	783	355	0.407	1.33	79.4	118

*@20°C (68°F)

California

1959 East Cashdan Street, Rancho Dominguez, CA 90220
 (310) 609-1811 • (800) 326-0006 • FAX: (310) 609-1862
 E-Mail: salesrd@std-wire.com

Arizona

3120 West Thomas Road, Bldg. #801, Phoenix, AZ 85017
 (602) 269-2501 • (800) 325-6478 • FAX: (602) 278-7134
 E-Mail: salesphx@std-wire.com



Standard Wire & Cable Co.

Electrical & Electronic Instrument Wire



CONDUCTOR: Stranded tinned copper.
INSULATION: PVC or PVC/nylon.

COLOR: See Color Code Chart No. 6 on page 33.

USES: This wire is intended for use as a general purpose hook-up wire for electronic equipment operating over a temperature range of -55° C to 105° C. The temperature rating may be exceeded approximately 10° C when the wire is covered with a nylon jacket per MIL-W-16878.

MIL-W-16878/1 Type B - 600 volt							MIL-W-16878/17 Type B/N - 600 volt				
AWG Size	Stranding	Catalog No.	Diameter PVC		Weight		Catalog No.	Diameter PVC/nylon		Weight	
			(in)	(mm)	(lbs / 1000 ft)	(kgs / km)		(in)	(mm)	(lbs / 1000 ft)	(kgs / km)
30	7/38	500-0	0.031	0.787	0.83	1.24	500-0A	0.035	0.89	1.00	1.49
28	7/36	500-1	0.034	0.864	1.01	1.50	500-1A	0.038	0.97	1.18	1.76
26	7/34	500-11	0.038	0.965	1.53	2.28	500-11AA	0.042	1.07	1.70	2.53
26	19/38	500-11A	0.038	0.965	1.73	2.57	500-11AB	0.042	1.07	2.16	3.21
24	7/32	500-22	0.043	1.09	2.14	3.18	500-22AA	0.047	1.19	2.45	3.65
24	19/36	500-22A	0.043	1.09	2.26	3.36	500-22AB	0.047	1.19	2.57	3.82
22	7/30	500-33	0.049	1.24	2.98	4.43	500-33AA	0.053	1.35	3.33	4.96
22	19/34	500-33A	0.049	1.24	3.11	4.63	500-33AB	0.053	1.35	3.46	5.15
20	7/28	500-44	0.057	1.45	4.62	6.87	500-44AA	0.061	1.55	5.02	7.47
20	19/32	500-44A	0.057	1.45	4.77	7.10	500-44AB	0.061	1.55	5.17	7.69
18	19/30	500-55A	0.067	1.70	7.22	10.7	500-55AB	0.072	1.83	7.69	11.4
16	19/29	500-66	0.077	1.96	9.04	13.5	500-66AB	0.082	2.08	9.65	14.4
14	19/27	500-77	0.091	2.31	13.9	20.6	500-77AB	0.098	2.49	14.6	21.7

MIL-W-16878/2 Type C - 1000 volt							MIL-W-16878/18 Type C/N - 1000 volt				
AWG Size	Stranding	Catalog No.	Diameter PVC		Weight		Catalog No.	Diameter PVC/nylon		Weight	
			(in)	(mm)	(lbs / 1000 ft)	(kgs / km)		(in)	(mm)	(lbs / 1000 ft)	(kgs / km)
26	7/36	501-11	0.053	1.35	2.00	2.98	501-11AA	0.057	1.45	2.20	3.27
26	19/38	501-11A	0.053	1.35	2.10	3.12	501-11AB	0.057	1.45	2.60	3.87
24	7/32	501-22	0.058	1.47	2.61	3.88	501-22AA	0.062	1.57	3.04	4.52
24	19/36	501-22A	0.058	1.47	2.74	4.08	501-22AB	0.062	1.57	3.17	4.72
22	7/30	501-33	0.064	1.63	3.51	5.22	501-33AA	0.069	1.75	4.02	5.98
22	19/34	501-33A	0.064	1.63	3.64	5.42	501-33AB	0.069	1.75	4.15	6.18
20	7/28	501-44	0.072	1.83	5.19	7.72	501-44AA	0.078	1.98	5.87	8.73
20	19/32	501-44A	0.072	1.83	5.57	8.29	501-44AB	0.078	1.98	6.25	9.30
18	19/30	501-55A	0.082	2.08	8.17	12.2	501-55AB	0.088	2.24	10.0	14.9
16	19/29	501-66	0.091	2.31	9.98	14.9	501-66AB	0.098	2.49	10.6	15.7
14	19/27	501-77	0.105	2.67	15.2	22.6	501-77AB	0.112	2.84	16.0	23.8
12	19/25	501-88	0.124	3.15	22.7	33.7	501-88AB	0.137	3.48	23.9	35.5

California

1959 East Cashdan Street, Rancho Dominguez, CA 90220
(310) 609-1811 • (800) 326-0006 • FAX: (310) 609-1862
E-Mail: salesrd@std-wire.com

Arizona

3120 West Thomas Road, Bldg. #801, Phoenix, AZ 85017
(602) 269-2501 • (800) 325-6478 • FAX: (602) 278-7134
E-Mail: salesphx@std-wire.com



Standard Wire & Cable Co.

Electrical & Electronic Instrument Wire



CONDUCTOR: Stranded tinned copper.
INSULATION: PVC or PVC/nylon.

COLOR: See Color Code Chart No. 6 on page 33.

USES: This wire is intended for use as a general purpose hook-up wire for electronic equipment operating over a temperature range of -55° C to 105° C. The temperature rating may be exceeded approximately 10° C when the wire is covered with a nylon jacket per MIL-W-16878.

		MIL-W-16878/3 Type D - 3000 volt					MIL-W-16878/19 Type D/N - 3000 volt				
AWG Size	Stranding	Catalog No.	Diameter PVC		Weight		Catalog No.	Diameter PVC/nylon		Weight	
			(in)	(mm)	(lbs / 1000 ft)	(kgs / km)		(in)	(mm)	(lbs / 1000 ft)	(kgs / km)
24	7/32	502-22	0.083	2.11	4.69	6.98	502-22AA	0.090	2.29	5.46	8.12
24	19/36	502-22A	0.083	2.11	4.82	7.17	502-22AB	0.090	2.29	5.59	8.32
22	7/30	502-33	0.089	2.26	5.97	8.88	502-33AA	0.096	2.44	6.74	10.0
22	19/34	502-33A	0.089	2.26	6.10	9.08	502-33AB	0.096	2.44	6.87	10.2
20	7/28	502-44	0.097	2.46	7.53	11.2	502-44AA	0.104	2.64	8.05	12.0
20	19/32	502-44A	0.097	2.46	7.75	11.5	502-44AB	0.104	2.64	8.26	12.3
18	19/30	502-55A	0.107	2.72	9.87	14.7	502-55AB	0.114	2.90	10.6	15.8
16	19/29	502-66	0.116	2.95	12.1	17.9	502-66AB	0.123	3.12	12.8	19.1
14	19/27	502-77	0.130	3.30	17.3	25.7	502-77AB	0.139	3.53	18.3	27.2
12	19/25	502-88	0.162	4.11	27.1	40.3	502-88AB	0.174	4.42	28.5	42.4
10	37/26	502-99	0.182	4.62	39.3	58.5	502-99AB	0.194	4.93	41.8	62.2
8	133/29	502-110	0.247	6.27	73.8	110	502-110AB	0.265	6.73	77.7	116
6	133/27	502-121	0.291	7.39	101	151	502-121AB	0.312	7.92	106	157
4	133/25	502-132	0.356	9.04	161	239	502-132AB	0.377	9.58	165	245
2	133/23	502-143	0.425	10.8	250	371	502-143AB	0.446	11.3	257	383
1	259/25	502-154	0.478	12.1	316	470	502-154AB	0.499	12.7	325	484
1/0	259/24	502-165	0.528	13.4	418	622	502-165AB	0.549	13.9	431	641

California

1959 East Cashdan Street, Rancho Dominguez, CA 90220
(310) 609-1811 • (800) 326-0006 • FAX: (310) 609-1862
E-Mail: salesrd@std-wire.com

Arizona

3120 West Thomas Road, Bldg. #801, Phoenix, AZ 85017
(602) 269-2501 • (800) 325-6478 • FAX: (602) 278-7134
E-Mail: salesphx@std-wire.com



Standard Wire & Cable Co.

Shielded & Jacketed Electrical & Electronic Instrument Wire Single Conductor

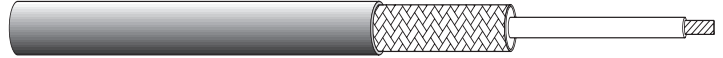

CONDUCTOR: Stranded tinned copper.
INSULATION: 105° C, PVC/nylon, white.* Conforms to MIL-W-16878.

SHIELD: Tinned copper braid.
JACKET: PVC or nylon jacket, white.*
VOLTAGE: 600 V, 1000 V, 3000 V

Type B/nylon 600 volt

Catalog No.	AWG Size	Stranding	Nominal Diameter		Weight	
			(in)	(mm)	(lbs / 1000 ft)	(kgs / km)
500-0D	30	7/38	0.073	1.85	5.37	7.99
500-1D	28	7/36	0.076	1.93	5.92	8.81
500-11D	26	7/34	0.080	2.03	7.23	10.8
500-22D	24	7/32	0.085	2.16	8.78	13.1
500-22DA	24	19/36	0.085	2.16	8.90	13.2
500-33D	22	7/30	0.096	2.44	9.66	14.4
500-33DA	22	19/34	0.096	2.44	9.79	14.6
500-44DA	20	19/32	0.104	2.64	13.1	19.4
500-55DA	18	19/30	0.117	2.97	17.2	25.6
500-66D	16	19/29	0.130	3.30	22.3	33.2
500-77D	14	19/27	0.146	3.71	26.4	39.3

Type C/nylon 1000 volt

501-11D	26	7/34	0.100	2.54	9.40	14.0
501-22D	24	7/32	0.105	2.67	10.4	15.4
501-22DA	24	19/36	0.105	2.67	10.5	15.6
501-33D	22	7/30	0.111	2.82	12.0	17.9
501-33DA	22	19/34	0.111	2.82	12.1	18.0
501-44DA	20	19/32	0.124	3.15	15.7	23.4
501-55DA	18	19/30	0.135	3.43	20.6	30.7
501-66D	16	19/29	0.145	3.68	22.3	33.2
501-77D	14	19/27	0.165	4.19	30.2	44.9
501-88D	12	19/25	0.188	4.78	40.9	60.8

Type D/nylon 3000 volt

502-22D	24	7/32	0.136	3.45	16.2	24.0
502-22DA	24	19/36	0.136	3.45	16.9	25.2
502-33D	22	7/30	0.142	3.61	18.1	27.0
502-33DA	22	19/34	0.142	3.61	18.9	28.1
502-44DA	20	19/32	0.154	3.91	21.2	31.5
502-55DA	18	19/30	0.166	4.22	25.0	37.2
502-66D	16	19/29	0.175	4.45	28.2	42.0
502-77D	14	19/27	0.196	4.98	36.6	54.4
502-88D	12	19/25	0.235	5.97	52.0	77.4
502-99D	10	37/26	0.260	6.60	68.7	102
502-110D	8	133/29	0.340	8.64	117	174
502-121D	6	133/27	0.401	10.2	157	233

* Both primary insulation and jacketing available in the following colors: Black, brown, red, orange, yellow, green, blue, purple, gray, and white. Colors conform to MIL-STD-104.

California

1959 East Cashdan Street, Rancho Dominguez, CA 90220
(310) 609-1811 • (800) 326-0006 • FAX: (310) 609-1862
E-Mail: salesrd@std-wire.com

Arizona

3120 West Thomas Road, Bldg. #801, Phoenix, AZ 85017
(602) 269-2501 • (800) 325-6478 • FAX: (602) 278-7134
E-Mail: salesphx@std-wire.com



Standard Wire & Cable Co.

Shielded & Jacketed Electrical & Electronic Instrument Wire

Two Conductor

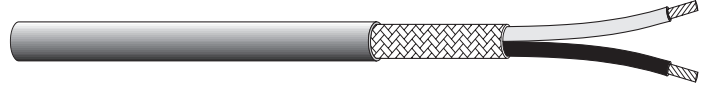

CONDUCTOR: Stranded tinned copper.
 INSULATION: 105° C, PVC/nylon, white, black.* Conforms to MIL-W-16878.

SHIELD: Tinned copper braid.
 JACKET: PVC or nylon jacket, white.*
 VOLTAGE: 600 V, 1000 V, 3000 V

Type B/nylon 600 volt

Catalog No.	AWG Size	Stranding	Nominal Diameter		Weight	
			(in)	(mm)	(lbs / 1000 ft)	(kgs / km)
500-12	26	7/34	0.132	3.35	14.0	20.8
500-23	24	7/32	0.142	3.61	16.5	24.6
500-23A	24	19/36	0.142	3.61	16.8	24.9
500-34A	22	19/34	0.158	4.01	20.4	30.4
500-45A	20	19/32	0.176	4.47	26.1	38.9
500-56A	18	19/30	0.202	5.13	34.4	51.1
500-67A	16	19/29	0.228	5.79	41.7	62.0
500-78A	14	19/27	0.264	6.71	55.9	83.1

Type C/nylon 1000 volt

501-23	24	7/32	0.180	4.57	22.1	32.9
501-23A	24	19/36	0.180	4.57	22.3	33.2
501-34A	22	19/34	0.194	4.93	26.0	38.7
501-45A	20	19/32	0.216	5.49	33.0	49.1
501-56A	18	19/30	0.242	6.15	44.3	65.9
501-67A	16	19/29	0.266	6.76	49.2	73.3
501-78A	14	19/27	0.302	7.67	65.8	97.9
501-89A	12	19/25	0.352	8.94	88.9	132

Type D/nylon 3000 volt

502-34A	22	19/34	0.258	6.55	40.8	60.7
502-45A	20	19/32	0.280	7.11	47.5	70.7
502-56A	18	19/30	0.302	7.67	55.3	82.3
502-67A	16	19/29	0.324	8.23	62.2	92.5
502-78A	14	19/27	0.364	9.25	80.7	120
502-89A	12	19/25	0.446	11.3	117	174
502-100A	10	37/26	0.504	12.8	157	233
502-111A	8	133/29	0.630	16.0	249	371

* Primary conductors are color coded per the requirements of MIL-C-7078 or MIL-C-915. Custom color coding is available upon request.

California

1959 East Cashdan Street, Rancho Dominguez, CA 90220
 (310) 609-1811 • (800) 326-0006 • FAX: (310) 609-1862
 E-Mail: salesrd@std-wire.com

Arizona

3120 West Thomas Road, Bldg. #801, Phoenix, AZ 85017
 (602) 269-2501 • (800) 325-6478 • FAX: (602) 278-7134
 E-Mail: salesphx@std-wire.com



Standard Wire & Cable Co.

Shielded & Jacketed Electrical & Electronic Instrument Wire Three Conductor

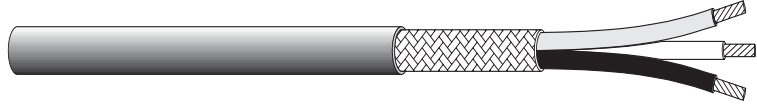

CONDUCTOR: Stranded tinned copper. SHIELD: Tinned copper braid.
 INSULATION: 105° C, PVC/nylon, white, black, red.* Conforms to MIL-W-16878. JACKET: PVC or nylon jacket, white.*
 VOLTAGE: 600 V, 1000 V, 3000 V

Type B/nylon 600 volt

Catalog No.	AWG Size	Stranding	Nominal Diameter		Weight	
			(in)	(mm)	(lbs / 1000 ft)	(kgs / km)
500-14	26	7/34	0.139	3.53	16.1	24.0
500-25	24	7/32	0.151	3.84	19.7	29.3
500-25A	24	19/36	0.151	3.84	20.1	29.8
500-36A	22	19/34	0.168	4.27	27.4	40.7
500-47A	20	19/32	0.187	4.75	31.8	47.4
500-58A	18	19/30	0.217	5.51	43.6	64.8
500-69A	16	19/29	0.243	6.17	53.1	79.0
500-80A	14	19/27	0.283	7.19	71.0	106

Type C/nylon 1000 volt

501-25	24	7/32	0.092	2.34	26.8	39.8
501-25A	24	19/36	0.206	5.23	27.2	40.4
501-36A	22	19/34	0.230	5.84	31.8	47.3
501-47A	20	19/32	0.257	6.53	47.4	70.5
501-58A	18	19/30	0.285	7.24	63.8	94.9
501-69A	16	19/29	0.321	8.15	73.3	109
501-80A	14	19/27	0.376	9.55	101	150
501-91A	12	19/25	0.390	9.91	123	183

Type D/nylon 3000 volt

502-36A	22	19/34	0.278	7.06	51.3	76.4
502-47A	20	19/32	0.298	7.57	58.2	86.6
502-58A	18	19/30	0.323	8.20	67.1	99.9
502-69A	16	19/29	0.349	8.86	78.4	117
502-80A	14	19/27	0.389	9.88	103	153
502-91A	12	19/25	0.483	12.3	152	226
502-102A	10	37/26	0.564	14.3	216	321
502-113A	8	133/29	0.705	17.9	356	529

* Primary conductors are color coded per the requirements of MIL-C-7078 or MIL-C-915. Custom color coding is available upon request.

California

1959 East Cashdan Street, Rancho Dominguez, CA 90220
 (310) 609-1811 • (800) 326-0006 • FAX: (310) 609-1862
 E-Mail: salesrd@std-wire.com

Arizona

3120 West Thomas Road, Bldg. #801, Phoenix, AZ 85017
 (602) 269-2501 • (800) 325-6478 • FAX: (602) 278-7134
 E-Mail: salesphx@std-wire.com



Standard Wire & Cable Co.

Shielded & Jacketed Electrical & Electronic Instrument Wire

Four Conductor

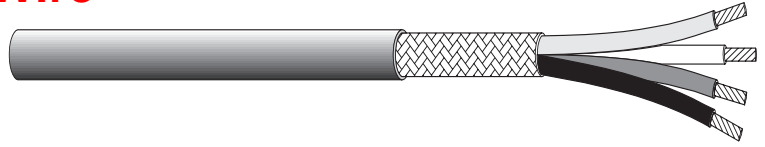

CONDUCTOR: Stranded tinned copper. SHIELD: Tinned copper braid.
 INSULATION: 105° C, PVC/nylon, white, black, red, green.* Conforms to MIL-W-16878. JACKET: PVC or nylon jacket, white.*
 VOLTAGE: 600 V, 1000 V, 3000 V

Type B/nylon 600 volt

Catalog No.	AWG Size	Stranding	Nominal Diameter		Weight	
			(in)	(mm)	(lbs / 1000 ft)	(kgs / km)
500-16	26	7/34	0.152	3.86	19.1	28.4
500-27	24	7/32	0.170	4.32	24.4	36.4
500-27A	24	19/36	0.170	4.32	24.9	37.1
500-38A	22	19/34	0.186	4.72	30.7	45.6
500-49A	20	19/32	0.208	5.28	39.5	58.7
500-60A	18	19/30	0.240	6.10	54.4	80.9
500-71A	16	19/29	0.270	6.86	65.9	98.1
500-82A	14	19/27	0.309	7.85	92.1	137

Type C/nylon 1000 volt

501-27	24	7/32	0.212	5.38	31.3	46.6
501-27A	24	19/36	0.212	5.38	31.9	47.4
501-38A	22	19/34	0.231	5.87	39.3	58.4
501-49A	20	19/32	0.248	6.30	49.4	73.5
501-60A	18	19/30	0.287	7.29	71.9	107
501-71A	16	19/29	0.315	8.00	77.6	115
501-82A	14	19/27	0.360	9.14	109	161
501-93A	12	19/25	0.413	10.5	149	221

Type D/nylon 3000 volt

502-38A	22	19/34	0.315	8.00	64.4	95.9
502-49A	20	19/32	0.338	8.59	75.5	112
502-60A	18	19/30	0.370	9.40	90.4	135
502-71A	16	19/29	0.396	10.1	105	156
502-82A	14	19/27	0.437	11.1	134	199
502-93A	12	19/25	0.539	13.7	199	296
502-104A	10	37/26	0.595	15.1	261	388
502-115A	8	133/29	0.790	20.1	465	692

* Primary conductors are color coded per the requirements of MIL-C-7078 or MIL-C-915. Custom color coding is available upon request.

California

1959 East Cashdan Street, Rancho Dominguez, CA 90220
 (310) 609-1811 • (800) 326-0006 • FAX: (310) 609-1862
 E-Mail: salesrd@std-wire.com

Arizona

3120 West Thomas Road, Bldg. #801, Phoenix, AZ 85017
 (602) 269-2501 • (800) 325-6478 • FAX: (602) 278-7134
 E-Mail: salesphx@std-wire.com



Standard Wire & Cable Co.

Extruded Teflon® Hook-Up Wire MIL-W-16878E/4 Type E



CONDUCTOR: Silver-plated or nickel-plated. VOLTAGE: 600 V
 TEMPERATURE: -65° C to 200° C (silver), COLOR: See Color Code Chart No. 6 on
 -65° C to 260° C (nickel). page 33.
 INSULATION: Extruded TFE Teflon®.

Catalog No.	AWG Size	Stranding	Strand Diameter		Diameter (minimum - maximum)		Nominal Wall Thickness		Weight	
			(in)	(mm)	(in)	(mm)	(in)	(mm)	(lbs / 1000 ft)	(kgs / km)
1100-10C	32	Solid	0.0080	0.2032	0.025 - 0.033	0.635 - 0.838	0.010	0.254	1.00	1.49
1100-10	32	7/40	0.0031	0.0787	0.026 - 0.034	0.660 - 0.864	0.010	0.254	1.00	1.49
1100-21C	30	Solid	0.0100	0.2540	0.026 - 0.034	0.660 - 0.864	0.010	0.254	1.05	1.56
1100-21	30	7/38	0.0040	0.1016	0.028 - 0.036	0.711 - 0.914	0.010	0.254	1.09	1.62
1100-32C	28	Solid	0.0126	0.3200	0.029 - 0.037	0.737 - 0.940	0.010	0.254	1.37	2.04
1100-32	28	7/36	0.0050	0.1270	0.031 - 0.039	0.787 - 0.991	0.010	0.254	1.37	2.04
1100-43C	26	Solid	0.0159	0.4039	0.032 - 0.040	0.813 - 1.02	0.010	0.254	1.81	2.69
1100-43	26	7/34	0.0063	0.1600	0.035 - 0.043	0.889 - 1.09	0.010	0.254	1.81	2.69
1100-43A	26	19/38	0.0040	0.1016	0.035 - 0.043	0.889 - 1.09	0.010	0.254	1.81	2.69
1100-54C	24	Solid	0.0201	0.5105	0.036 - 0.044	0.914 - 1.12	0.010	0.254	2.39	3.56
1100-54	24	7/32	0.0080	0.2032	0.040 - 0.048	1.02 - 1.22	0.010	0.254	2.39	3.56
1100-54A	24	19/36	0.0050	0.1270	0.040 - 0.048	1.02 - 1.22	0.010	0.254	2.39	3.56
1100-65C	22	Solid	0.0253	0.6426	0.041 - 0.049	1.04 - 1.24	0.010	0.254	3.44	5.12
1100-65	22	7/30	0.0100	0.2540	0.046 - 0.054	1.17 - 1.37	0.010	0.254	3.52	5.24
1100-65A	22	19/34	0.0063	0.1600	0.046 - 0.054	1.17 - 1.37	0.010	0.254	3.44	5.12
1100-76C	20	Solid	0.0320	0.8128	0.048 - 0.056	1.22 - 1.42	0.010	0.254	4.97	7.40
1100-76	20	7/28	0.0126	0.3200	0.054 - 0.062	1.37 - 1.57	0.010	0.254	5.00	7.44
1100-76A	20	19/32	0.0080	0.2032	0.054 - 0.062	1.37 - 1.57	0.010	0.254	4.97	7.40
1100-87C	18	Solid	0.0403	1.0236	0.056 - 0.066	1.42 - 1.68	0.010	0.254	7.53	11.2
1100-87A	18	19/30	0.0100	0.2540	0.064 - 0.074	1.63 - 1.88	0.010	0.254	7.53	11.2
1100-98A	16	19/29	0.0113	0.2870	0.073 - 0.087	1.85 - 2.21	0.010	0.254	10.3	15.3
1100-109A	14	19/27	0.0142	0.3607	0.088 - 0.102	2.24 - 2.59	0.010	0.254	15.2	22.6
1100-120A	12	19/25	0.0179	0.4547	0.107 - 0.121	2.72 - 3.07	0.010	0.254	22.4	33.3
1100-131A	10	37/26	0.0159	0.4039	0.127 - 0.141	3.23 - 3.58	0.010	0.254	25.2	37.5

Teflon® is a trademark of the DuPont de Nemours Co.

- Conforms to MIL-STD-104.
- Spiral striped color coding as required.
- Can be supplied to NAS-703

MIL-W-16878/4 Rev. E is not printed.
 For MIL-W-16878/4 Rev. F, see page 61.

California

1959 East Cashdan Street, Rancho Dominguez, CA 90220
 (310) 609-1811 • (800) 326-0006 • FAX: (310) 609-1862
 E-Mail: salesrd@std-wire.com

Arizona

3120 West Thomas Road, Bldg. #801, Phoenix, AZ 85017
 (602) 269-2501 • (800) 325-6478 • FAX: (602) 278-7134
 E-Mail: salesphx@std-wire.com



Standard Wire & Cable Co.

Extruded Teflon® Hook-Up Wire MIL-W-16878E/5 Type EE



CONDUCTOR: Silver-plated or nickel-plated. INSULATION: Extruded TFE Teflon®.
 TEMPERATURE: -65° C to 200° C (silver), VOLTAGE: 1000 V
 -65° C to 260° C (nickel). COLOR: See Color Code Chart No. 6 on page 33.

Catalog No.	AWG Size	Stranding	Strand Diameter		Diameter (minimum - maximum)		Nominal Wall Thickness		Weight	
			(in)	(mm)	(in)	(mm)	(in)	(mm)	(lbs / 1000 ft)	(kgs / km)
1101-21C	30	Solid	0.0100	0.2540	0.036 - 0.044	0.914 - 1.12	0.015	0.381	1.50	2.23
1101-21	30	7/38	0.0040	0.1016	0.038 - 0.046	0.965 - 1.17	0.015	0.381	1.54	2.29
1101-32C	28	Solid	0.0126	0.3200	0.039 - 0.047	0.991 - 1.19	0.015	0.381	1.78	2.65
1101-32	28	7/36	0.0050	0.1270	0.041 - 0.049	1.04 - 1.24	0.015	0.381	1.85	2.75
1101-43C	26	Solid	0.0159	0.4039	0.042 - 0.050	1.07 - 1.27	0.015	0.381	2.00	2.98
1101-43	26	7/34	0.0063	0.1600	0.045 - 0.053	1.14 - 1.35	0.015	0.381	2.34	3.48
1101-43A	26	19/38	0.0040	0.1016	0.045 - 0.053	1.14 - 1.35	0.015	0.381	2.34	3.48
1101-54C	24	Solid	0.0201	0.5105	0.046 - 0.054	1.17 - 1.37	0.015	0.381	3.00	4.46
1101-54	24	7/32	0.0080	0.2032	0.050 - 0.058	1.27 - 1.47	0.015	0.381	3.11	4.63
1101-54A	24	19/36	0.0050	0.1270	0.050 - 0.058	1.27 - 1.47	0.015	0.381	3.11	4.63
1101-65C	22	Solid	0.0253	0.6426	0.051 - 0.060	1.30 - 1.52	0.015	0.381	4.00	5.95
1101-65	22	7/30	0.0100	0.2540	0.056 - 0.064	1.42 - 1.63	0.015	0.381	4.17	6.20
1101-65A	22	19/34	0.0063	0.1600	0.056 - 0.064	1.42 - 1.63	0.015	0.381	4.25	6.32
1101-76C	20	Solid	0.0320	0.8128	0.058 - 0.066	1.47 - 1.68	0.015	0.381	5.00	7.44
1101-76	20	7/28	0.0126	0.3200	0.064 - 0.072	1.63 - 1.83	0.015	0.381	5.76	8.57
1101-76A	20	19/32	0.0080	0.2032	0.064 - 0.072	1.63 - 1.83	0.015	0.381	5.98	8.90
1101-87C	18	Solid	0.0403	1.0236	0.066 - 0.076	1.68 - 1.93	0.015	0.381	8.00	11.9
1101-87A	18	19/30	0.0100	0.2540	0.074 - 0.084	1.88 - 2.13	0.015	0.381	8.62	12.8
1101-98A	16	19/29	0.0113	0.2870	0.083 - 0.095	2.11 - 2.41	0.015	0.381	10.90	16.22
1101-109A	14	19/27	0.0142	0.3607	0.098 - 0.114	2.49 - 2.90	0.015	0.381	16.23	24.15
1101-120A	12	19/25	0.0179	0.4547	0.117 - 0.133	2.97 - 3.38	0.015	0.381	25.22	37.53
1101-131A	10	37/26	0.0159	0.4039	0.137 - 0.153	3.48 - 3.89	0.015	0.381	33.17	49.36
1101-142A	8	133/29	0.0113	0.2870	0.199 - 0.219	5.05 - 5.56	0.015	0.381	61.14	90.98

Teflon® is a trademark of the DuPont de Nemours Co.

- Conforms to MIL-STD-104.
- Spiral striped color coding as required.

MIL-W-16878/5 Rev. E is not printed.
 For MIL-W-16878/5 Rev. F, see page 61.

California

1959 East Cashdan Street, Rancho Dominguez, CA 90220
 (310) 609-1811 • (800) 326-0006 • FAX: (310) 609-1862
 E-Mail: salesrd@std-wire.com

Arizona

3120 West Thomas Road, Bldg. #801, Phoenix, AZ 85017
 (602) 269-2501 • (800) 325-6478 • FAX: (602) 278-7134
 E-Mail: salesphx@std-wire.com



Standard Wire & Cable Co.

Extruded Teflon® Hook-Up Wire MIL-W-16878E/6 Type ET



CONDUCTOR: Silver-plated or nickel-plated. INSULATION: Extruded TFE Teflon®.
 TEMPERATURE: -65° C to 200° C (silver), VOLTAGE: 250 V
 -65° C to 260° C (nickel). COLOR: See Color Code Chart No. 6 on page 33.

Catalog No.	AWG Size	Stranding	Strand Diameter		Diameter (minimum - maximum)		Nominal Wall Thickness		Weight	
			(in)	(mm)	(in)	(mm)	(in)	(mm)	(lbs / 1000 ft)	(kgs / km)
1050-3-9	32	7/40	0.0031	0.0787	0.020 - 0.024	0.508 - 0.610	0.006	0.152	0.46	0.68
1050-4-9C	30	Solid	0.0100	0.2540	0.020 - 0.024	0.508 - 0.610	0.006	0.152	0.61	0.91
1050-4-9	30	7/38	0.0040	0.1016	0.022 - 0.026	0.559 - 0.660	0.006	0.152	0.66	0.98
1050-5-9C	28	Solid	0.0126	0.3200	0.023 - 0.027	0.584 - 0.686	0.006	0.152	0.85	1.26
1050-5-9	28	7/36	0.0050	0.1270	0.025 - 0.029	0.635 - 0.737	0.006	0.152	0.92	1.37
1050-5-9A	28	19/40	0.0031	0.0787	0.025 - 0.029	0.635 - 0.737	0.006	0.152	1.02	1.52
1050-6-9	26	7/34	0.0063	0.1600	0.029 - 0.033	0.737 - 0.838	0.006	0.152	1.31	1.95
1050-6-9A	26	19/38	0.0040	0.1016	0.029 - 0.033	0.737 - 0.838	0.006	0.152	1.41	2.10
1050-7-9	24	7/32	0.0080	0.2032	0.034 - 0.038	0.864 - 0.965	0.006	0.152	1.91	2.84
1050-7-9A	24	19/36	0.0050	0.1270	0.034 - 0.038	0.864 - 0.965	0.006	0.152	2.03	3.02
1050-8-9	22	7/30	0.0100	0.2540	0.040 - 0.044	1.02 - 1.12	0.006	0.152	2.83	4.21
1050-8-9A	22	19/34	0.0063	0.1600	0.040 - 0.044	1.02 - 1.12	0.006	0.152	3.02	4.49
1050-9-9A	20	19/32	0.0080	0.2032	0.048 - 0.052	1.22 - 1.32	0.006	0.152	4.56	6.79

Teflon® is a trademark of the DuPont de Nemours Co.

- Conforms to MIL-STD-104.
- Spiral striped color coding as required.

California

1959 East Cashdan Street, Rancho Dominguez, CA 90220
 (310) 609-1811 • (800) 326-0006 • FAX: (310) 609-1862
 E-Mail: salesrd@std-wire.com

Arizona

3120 West Thomas Road, Bldg. #801, Phoenix, AZ 85017
 (602) 269-2501 • (800) 325-6478 • FAX: (602) 278-7134
 E-Mail: salesphx@std-wire.com



Standard Wire & Cable Co.

MIL-W-16878 Rev. F Supersession of Duplicate Strandings to MIL-W-22759

Former MIL-W-16878 P/N	Description	Replacement MIL-W-22759 P/N
MIL-W-16878/4-BCB	E28-7	MIL-W-22759/11-28
MIL-W-16878/4-BDE	E26-19	MIL-W-22759/11-26
MIL-W-16878/4-BEE	E24-19	MIL-W-22759/11-24
MIL-W-16878/4-BFE	E22-19	MIL-W-22759/11-22
MIL-W-16878/4-BGE	E20-19	MIL-W-22759/11-20
MIL-W-16878/4-BHE	E18-19	MIL-W-22759/11-18
MIL-W-16878/4-BJE	E16-19	MIL-W-22759/11-16
MIL-W-16878/4-BKE	E14-19	MIL-W-22759/11-14
MIL-W-16878/4-BLE	E12-19	MIL-W-22759/11-12
MIL-W-16878/4-BMG	E10-37	MIL-W-22759/11-10
MIL-W-16878/4-DCB	E28-7 Alloy	MIL-W-22759/22-28
MIL-W-16878/4-DDE	E26-19 Alloy	MIL-W-22759/22-26
MIL-W-16878/4-DEE	E24-19 Alloy	MIL-W-22759/22-24
MIL-W-16878/4-DFE	E22-19 Alloy	MIL-W-22759/22-22
MIL-W-16878/4-DGE	E20-19 Alloy	MIL-W-22759/22-20
MIL-W-16878/5-BCB	EE28-7	MIL-W-22759/9-28
MIL-W-16878/5-BDE	EE26-19	MIL-W-22759/9-26
MIL-W-16878/5-BEE	EE24-19	MIL-W-22759/9-24
MIL-W-16878/5-BFE	EE22-19	MIL-W-22759/9-22
MIL-W-16878/5-BGE	EE20-19	MIL-W-22759/9-20
MIL-W-16878/5-BHE	EE18-19	MIL-W-22759/9-18
MIL-W-16878/5-BJE	EE16-19	MIL-W-22759/9-16
MIL-W-16878/5-BKE	EE14-19	MIL-W-22759/9-14
MIL-W-16878/5-BLE	EE12-19	MIL-W-22759/9-12
MIL-W-16878/5-BMG	EE10-37	MIL-W-22759/9-10
MIL-W-16878/5-BNL	EE8-133	MIL-W-22759/9-8
MIL-W-16878/5-DCB	EE28-7 Alloy	MIL-W-22759/20-28
MIL-W-16878/5-DDE	EE26-19 Alloy	MIL-W-22759/20-26
MIL-W-16878/5-DEE	EE24-19 Alloy	MIL-W-22759/20-24
MIL-W-16878/5-DFE	EE22-19 Alloy	MIL-W-22759/20-22
MIL-W-16878/5-DGE	EE20-19 Alloy	MIL-W-22759/20-20

Former MIL-W-16878 P/N	Description	Replacement MIL-W-22759 P/N
MIL-W-16878/25-BCB	E28-7 Nickel	MIL-W-22759/12-28
MIL-W-16878/25-BDE	E26-19 Nickel	MIL-W-22759/12-26
MIL-W-16878/25-BEE	E24-19 Nickel	MIL-W-22759/12-24
MIL-W-16878/25-BFE	E22-19 Nickel	MIL-W-22759/12-22
MIL-W-16878/25-BGE	E20-19 Nickel	MIL-W-22759/12-20
MIL-W-16878/25-BHE	E18-19 Nickel	MIL-W-22759/12-18
MIL-W-16878/25-BJE	E16-19 Nickel	MIL-W-22759/12-16
MIL-W-16878/25-BKE	E14-19 Nickel	MIL-W-22759/12-14
MIL-W-16878/25-BLE	E12-19 Nickel	MIL-W-22759/12-12
MIL-W-16878/25-BMG	E10-37 Nickel	MIL-W-22759/12-10
MIL-W-16878/25-DCB	E28-7 Nickel Alloy	MIL-W-22759/23-28
MIL-W-16878/25-DDE	E26-19 Nickel Alloy	MIL-W-22759/23-26
MIL-W-16878/25-DEE	E24-19 Nickel Alloy	MIL-W-22759/23-24
MIL-W-16878/25-DFE	E22-19 Nickel Alloy	MIL-W-22759/23-22
MIL-W-16878/25-DGE	E20-19 Nickel Alloy	MIL-W-22759/23-20
MIL-W-16878/27-BCB	EE28-7 Nickel	MIL-W-22759/10-28
MIL-W-16878/27-BDE	EE26-19 Nickel	MIL-W-22759/10-26
MIL-W-16878/27-BEE	EE24-19 Nickel	MIL-W-22759/10-24
MIL-W-16878/27-BFE	EE22-19 Nickel	MIL-W-22759/10-22
MIL-W-16878/27-BGE	EE20-19 Nickel	MIL-W-22759/10-20
MIL-W-16878/27-BHE	EE18-19 Nickel	MIL-W-22759/10-18
MIL-W-16878/27-BJE	EE16-19 Nickel	MIL-W-22759/10-16
MIL-W-16878/27-BKE	EE14-19 Nickel	MIL-W-22759/10-14
MIL-W-16878/27-BLE	EE12-19 Nickel	MIL-W-22759/10-12
MIL-W-16878/27-BMG	EE10-37 Nickel	MIL-W-22759/10-10
MIL-W-16878/27-BNL	EE8-133 Nickel	MIL-W-22759/10-8
MIL-W-16878/27-DCB	EE28-7 Nickel Alloy	MIL-W-22759/21-28
MIL-W-16878/27-DDE	EE26-19 Nickel Alloy	MIL-W-22759/21-26
MIL-W-16878/27-DEE	EE24-19 Nickel Alloy	MIL-W-22759/21-24
MIL-W-16878/27-DFE	EE22-19 Nickel Alloy	MIL-W-22759/21-22
MIL-W-16878/27-DGE	EE20-19 Nickel Alloy	MIL-W-22759/21-20

California

1959 East Cashdan Street, Rancho Dominguez, CA 90220
 (310) 609-1811 • (800) 326-0006 • FAX: (310) 609-1862
 E-Mail: salesrd@std-wire.com

Arizona

3120 West Thomas Road, Bldg. #801, Phoenix, AZ 85017
 (602) 269-2501 • (800) 325-6478 • FAX: (602) 278-7134
 E-Mail: salesphx@std-wire.com



Standard Wire & Cable Co.

MIL-W-16878 Cable Designation

All MIL-W-16878 cables are designated by a six field code that indicates the exact construction of each cable. Please note the following example of a MIL-W-16878/5-DCB-2 cable.

Cable Description: MIL-W-16878/5 -DCB-2

(1) (2) (3)(4)(5) (6)

Prefix (1): All MIL-W-16878 cables will carry this prefix.

Specification Number (2): This number code position identifies the type, voltage rating, insulation, nominal wall thickness, conductor coating, and maximum temperature rating of the cable.

Conductor Material (3): This letter code position identifies the material the conductor is made of.

Conductor Size (4): This letter code position identifies the wire size.

Conductor Stranding (5): This letter code position identifies the conductor stranding.

Color Code (6): This number designates the color of the insulation material.

Specification Number

Military Specification	Type	Voltage Rating (RMS)	Insulation	Nominal Wall Thickness		Conductor Coating *	Temp. Rating Max. (°C)
				(in)	(mm)		
MIL-W-16878 /1	B	600	PVC	0.010	0.254	Tin	105
MIL-W-16878 /2	C	1,000	PVC	0.015	0.381	Tin	105
MIL-W-16878 /3	D	3,000	PVC	0.030	0.762	Tin	105
MIL-W-16878 /4	E	600	PTFE	0.010	0.254	Silver	200
MIL-W-16878 /5	EE	1,000	PTFE	0.015	0.381	Silver	200
MIL-W-16878 /6	ET	250	PTFE	0.006	0.152	Silver	200
MIL-W-16878 /11	K	600	FEP	0.010	0.254	Silver	200
MIL-W-16878 /12	KK	1,000	FEP	0.015	0.381	Silver	200
MIL-W-16878 /13	KT	250	FEP	0.006	0.152	Silver	200
MIL-W-16878 /20		250	PTFE tape	0.006	0.152	Silver	200
MIL-W-16878 /21		600	PTFE tape	0.010	0.254	Silver	200
MIL-W-16878 /22		1,000	PTFE tape	0.015	0.381	Silver	200
MIL-W-16878 /23	ET	250	PTFE	0.006	0.152	Nickel	260
MIL-W-16878 /24		250	PTFE tape	0.006	0.152	Nickel	260
MIL-W-16878 /25	E	600	PTFE	0.010	0.254	Nickel	260
MIL-W-16878 /26		600	PTFE tape	0.010	0.254	Nickel	260
MIL-W-16878 /27	EE	1,000	PTFE	0.015	0.381	Nickel	260
MIL-W-16878 /28		1,000	PTFE tape	0.015	0.381	Nickel	260

* Coatings are those listed in the Military Specification, others available upon request.

California

1959 East Cashdan Street, Rancho Dominguez, CA 90220
(310) 609-1811 • (800) 326-0006 • FAX: (310) 609-1862
E-Mail: salesrd@std-wire.com

Arizona

3120 West Thomas Road, Bldg. #801, Phoenix, AZ 85017
(602) 269-2501 • (800) 325-6478 • FAX: (602) 278-7134
E-Mail: salesphx@std-wire.com



Standard Wire & Cable Co.

Conductor Material	
B	coated copper
C	coated copper covered steel
D	coated high strength copper alloy
E	coated copper with overall metallic coating

Color Code	
Number Designation	Color
0	black
1	brown
2	red
3	orange
4	yellow
5	green
6	blue
7	violet (purple)
8	gray
9	white

Conductor Size	
Letter	AWG
A	32
B	30
C	28
D	26
E	24
F	22
G	20
H	18
J	16
K	14
L	12
M	10
N	8
P	6
R	4
S	2
T	1
U	0
W	00
Y	000
Z	0000

Conductor Stranding	
Letter	Number of Strands
A	1 (solid)
B	7
C	10
D	16
E	19
F	26
G	37
H	41
J	65
K	105
L	133
M	168
N	259
P	665
R	817
S	1,045
T	1,330
V	1,672
W	2,109

California

1959 East Cashdan Street, Rancho Dominguez, CA 90220
 (310) 609-1811 • (800) 326-0006 • FAX: (310) 609-1862
 E-Mail: salesrd@std-wire.com

Arizona

3120 West Thomas Road, Bldg. #801, Phoenix, AZ 85017
 (602) 269-2501 • (800) 325-6478 • FAX: (602) 278-7134
 E-Mail: salesphx@std-wire.com



Standard Wire & Cable Co.

Class H Shielded & Jacketed Miniature Cables

- CONDUCTOR:** Stranded silver-plated or nickel-plated copper.
- CONSTRUCTION:** Dielectric is Teflon® with 0.008" / 0.012" wall thickness. Cable twisting 1.5 to 2.5 inch lay. Shield is silver-plated or nickel-plated copper, 90% minimum coverage.
- JACKET:** Extruded or wrapped Teflon® with 0.008" / 0.012" wall thickness. Saturated glass fiber braid jackets are also available.
- SPECIFICATION:** The individually insulated conductors are manufactured to meet the requirements of MIL-W-16878 Type E. These conductors can also be manufactured in Type EE (1000 volt), or manufactured to MIL-C-55021 & MIL-C-27500 upon request.
- COLOR:** Primary conductors are color coded per the requirements of MIL-C-915. Custom color coding per your requirement is available upon request. All colors remain fast on continuous exposure to light, heat, or solvents, and conform to MIL-STD-104. Primary insulation (dielectric) and wrapped Teflon® jackets are available in the following colors: Black, brown, red, orange, yellow, green, blue, purple, gray, and white.
- USES:** When temperature requirements range from -65° C to 260° C at 600 volt RMS maximum (silver-plated: -65° C to 200° C; nickel-plated: -65° C to 260° C.)

Single Conductor



Catalog No.	AWG Size	Stranding	Conductor O.D.		Insulation O.D.		Shield O.D.		Jacket O.D.		Weight	
			(in)	(mm)	(in)	(mm)	(in)	(mm)	(in)	(mm)	(lbs / 1000 ft)	(kg / km)
1100-21E	30	7/38	0.012	0.30	0.032	0.81	0.055	1.40	0.071	1.80	5.8	8.6
1100-21F												
1100-32E	28	7/36	0.015	0.38	0.035	0.89	0.058	1.47	0.074	1.88	5.9	8.8
1100-32F												
1100-43E	26	19/38	0.019	0.48	0.039	0.99	0.062	1.57	0.078	1.98	7.9	11.8
1100-43F												
1100-54E	24	19/36	0.025	0.64	0.045	1.14	0.068	1.73	0.084	2.13	8.9	13.2
1100-54F												
1100-65E	22	19/34	0.031	0.79	0.051	1.30	0.074	1.88	0.090	2.29	10.5	15.6
1100-65F												
1100-76E	20	19/32	0.040	1.02	0.060	1.52	0.083	2.11	0.099	2.51	13.3	19.8
1100-76F												
1100-87E	18	19/30	0.050	1.27	0.070	1.78	0.093	2.36	0.109	2.77	18.5	27.5
1100-87F												
1100-98E	16	19/29	0.057	1.45	0.080	2.03	0.103	2.62	0.119	3.02	20.8	31.0
1100-98F												
1100-109E	14	19/27	0.071	1.80	0.096	2.45	0.121	3.07	0.138	3.51	26.5	39.4
1100-109F												
1100-120E	12	19/25	0.090	2.29	0.110	2.79	0.135	3.43	0.152	3.86	35.0	52.1
1100-120F												

E = Wrapped Teflon® jacket.

F = Extruded Teflon® jacket.

All dimensions are nominal.

Teflon® is a trademark of the DuPont de Nemours Co.

California

1959 East Cashdan Street, Rancho Dominguez, CA 90220
(310) 609-1811 • (800) 326-0006 • FAX: (310) 609-1862
E-Mail: salesrd@std-wire.com

Arizona

3120 West Thomas Road, Bldg. #801, Phoenix, AZ 85017
(602) 269-2501 • (800) 325-6478 • FAX: (602) 278-7134
E-Mail: salesphx@std-wire.com



Standard Wire & Cable Co.

Two Conductor

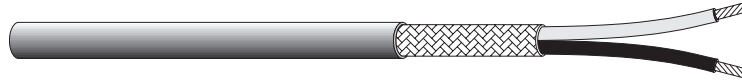

Catalog No.	AWG Size	Stranding	Conductor O.D.		Insulation O.D.		Shield O.D.		Jacket O.D.		Weight	
			(in)	(mm)	(in)	(mm)	(in)	(mm)	(in)	(mm)	(lbs / 1000 ft)	(kg / km)
1100-22E	30	7/38	0.012	0.30	0.032	0.81	0.086	2.18	0.107	2.72	10.7	15.9
1100-22F												
1100-33E	28	7/36	0.015	0.38	0.035	0.89	0.092	2.34	0.113	2.87	11.1	16.5
1100-33F												
1100-44E	26	19/38	0.019	0.48	0.039	0.99	0.100	2.54	0.122	3.10	13.5	20.1
1100-44F												
1100-55E	24	19/36	0.025	0.64	0.045	1.14	0.112	2.84	0.135	3.43	16.2	24.1
1100-55F												
1100-66E	22	19/34	0.031	0.79	0.051	1.30	0.124	3.15	0.148	3.76	19.5	29.0
1100-66F												
1100-77E	20	19/32	0.040	1.02	0.060	1.52	0.142	3.61	0.167	4.24	24.8	36.9
1100-77F												
1100-88E	18	19/30	0.050	1.27	0.070	1.78	0.162	4.11	0.189	4.80	31.4	46.7
1100-88F												
1100-99E	16	19/29	0.057	1.45	0.080	2.03	0.188	4.78	0.208	5.28	38.6	57.4
1100-99F												

E = Wrapped Teflon® jacket.

F = Extruded Teflon® jacket.

All dimensions are nominal.

Three Conductor

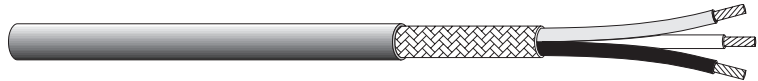

Catalog No.	AWG Size	Stranding	Conductor O.D.		Insulation O.D.		Shield O.D.		Jacket O.D.		Weight	
			(in)	(mm)	(in)	(mm)	(in)	(mm)	(in)	(mm)	(lbs / 1000 ft)	(kg / km)
1100-22S	30	7/38	0.012	0.30	0.032	0.81	0.092	2.34	0.114	2.90	11.7	17.4
1100-22T												
1100-33S	28	7/36	0.015	0.38	0.035	0.89	0.098	2.49	0.120	3.05	13.1	19.5
1100-33T												
1100-44S	26	19/38	0.019	0.48	0.039	0.99	0.107	2.72	0.129	3.28	15.8	23.5
1100-44T												
1100-55S	24	19/36	0.025	0.64	0.045	1.14	0.119	3.02	0.135	3.43	19.5	29.0
1100-55T												
1100-66S	22	19/34	0.031	0.79	0.051	1.30	0.132	3.35	0.148	3.76	23.7	35.3
1100-66T												
1100-77S	20	19/32	0.040	1.02	0.060	1.52	0.151	3.84	0.167	4.24	30.8	45.8
1100-77T												
1100-88S	18	19/30	0.050	1.27	0.070	1.78	0.173	4.39	0.189	4.80	41.5	61.8
1100-88T												
1100-99S	16	19/29	0.057	1.45	0.080	2.03	0.195	4.95	0.213	5.41	49.5	73.7
1100-99T												

S = Wrapped Teflon® jacket.

T = Extruded Teflon® jacket.

All dimensions are nominal.

Teflon® is a trademark of the DuPont de Nemours Co.

California

1959 East Cashdan Street, Rancho Dominguez, CA 90220
(310) 609-1811 • (800) 326-0006 • FAX: (310) 609-1862
E-Mail: salesrd@std-wire.com

Arizona

3120 West Thomas Road, Bldg. #801, Phoenix, AZ 85017
(602) 269-2501 • (800) 325-6478 • FAX: (602) 278-7134
E-Mail: salesphx@std-wire.com



Standard Wire & Cable Co.

Four Conductor

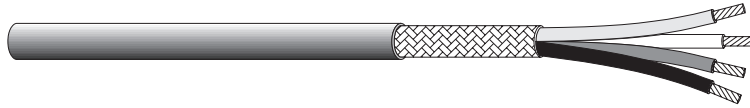

Catalog No.	AWG Size	Stranding	Conductor O.D.		Insulation O.D.		Shield O.D.		Jacket O.D.		Weight	
			(in)	(mm)	(in)	(mm)	(in)	(mm)	(in)	(mm)	(lbs / 1000 ft)	(kgs / km)
1100-22W	30	7/38	0.012	0.30	0.032	0.81	0.100	2.54	0.116	2.95	13.1	19.5
1100-22X												
1100-33W	28	7/36	0.015	0.38	0.035	0.89	0.108	2.74	0.124	3.15	15.9	23.7
1100-33X												
1100-44W	26	19/38	0.019	0.48	0.039	0.99	0.117	2.97	0.133	3.38	18.6	27.7
1100-44X												
1100-55W	24	19/36	0.025	0.64	0.045	1.14	0.132	3.35	0.148	3.76	22.8	33.9
1100-55X												
1100-66W	22	19/34	0.031	0.79	0.051	1.30	0.146	3.71	0.162	4.11	28.0	41.7
1100-66X												
1100-77W	20	19/32	0.040	1.02	0.060	1.52	0.168	4.27	0.184	4.67	37.7	56.1
1100-77X												
1100-88W	18	19/30	0.050	1.27	0.070	1.78	0.192	4.88	0.208	5.28	48.5	72.2
1100-88X												
1100-99W	16	19/29	0.057	1.45	0.080	2.03	0.218	5.54	0.236	5.99	59.9	89.1
1100-99X												

W = Wrapped Teflon® jacket.

X = Extruded Teflon® jacket.

All dimensions are nominal.

Teflon® is a trademark of the DuPont de Nemours Co.

California

1959 East Cashdan Street, Rancho Dominguez, CA 90220
 (310) 609-1811 • (800) 326-0006 • FAX: (310) 609-1862
 E-Mail: salesrd@std-wire.com

Arizona

3120 West Thomas Road, Bldg. #801, Phoenix, AZ 85017
 (602) 269-2501 • (800) 325-6478 • FAX: (602) 278-7134
 E-Mail: salesphx@std-wire.com



Standard Wire & Cable Co.



MIL-C-13486

Type I, Class A Cable, Special Purpose, Electrical, Low Tension

CONDUCTOR: Stranded tinned copper. CONSTRUCTION: Heavy-duty, single conductor with glass reinforcing braid.
 COLOR: Black.
 INSULATION: Neoprene® or Hypalon®.
 USES: All types of military vehicles such as trucks, trailers, tanks, etc., because of its excellent resistance to abrasion, fungus, and exposure to weather. Resists deterioration from fluids usually met in heavy duty vehicle applications such as oils, ethylene glycol, and salt water.

Catalog No.	AWG Size	Military Part No.	Formerly Ordnance Part No.	Conductor Strand	Diameter		Weight	
					(in)	(mm)	(lbs / 1000 ft)	(kgs / km)
706-3G	18	M13486/1-2	None	16/30	0.130	3.30	14.0	20.8
706-5G	16	M13486/1-3	7722204	19/29	0.135	3.43	16.5	24.6
706-5GA ¹	16	M13486/1-4	8690176	19/29	0.160	4.06	19.2	28.6
706-7G	14	M13486/1-5	7720853	19/27	0.160	4.06	22.2	33.0
706-7GA ¹	14	M13486/1-6	7056679	19/27	0.235	5.97	36.5	54.3
706-8G	12	M13486/1-7	7056678	19/25	0.235	5.97	42.2	62.8
706-11G	10	M13486/1-8	None	105/30	0.300	7.62	73.0	109
706-14G	8	M13486/1-9	7056677	133/29	0.360	9.14	104	154
706-15G	6	M13486/1-10	7056676	133/27	0.422	10.7	152	226
706-16G	4	M13486/1-11	8690175	133/25	0.485	12.3	221	328
706-17G	2	M13486/1-12	7056675	663/30	0.610	15.5	352	523
706-18G	1/0	M13486/1-14	7056674	1,033/30	0.672	17.1	478	711
706-19G	2/0	M13486/1-15	None	1,327/30	0.730	18.5	605	900
706-21G	4/0	M13486/1-17	7056674-1	2,104/30	0.865	22.0	871	1,296

¹ Available only through special order.

Neoprene® is a trademark of the DuPont de Nemours Co.

Hypalon® is a trademark of the DuPont de Nemours Co.

California

1959 East Cashdan Street, Rancho Dominguez, CA 90220
(310) 609-1811 • (800) 326-0006 • FAX: (310) 609-1862
E-Mail: salesrd@std-wire.com

Arizona

3120 West Thomas Road, Bldg. #801, Phoenix, AZ 85017
(602) 269-2501 • (800) 325-6478 • FAX: (602) 278-7134
E-Mail: salesphx@std-wire.com



Standard Wire & Cable Co.

Flexible Strand Pigtail



CONDUCTOR: Soft stranded tinned copper.
 CONSTRUCTION: Rope lay, close right-hand lay, extra flexible.
 USES: Shunt leads, brush leads, magnetic switches, relays, etc.

Catalog No.	AWG Size	Wires & Ropes	Nominal Diameter		Weight	
			(in)	(mm)	(lbs / 1000 ft)	(kgs / km)
301-3	20	7 x 15 x 40	0.040	1.02	3.20	4.76
301-6	18	7 x 21 x 40	0.052	1.32	5.12	7.62
301-9	16	7 x 15 x 36	0.067	1.70	8.13	12.10
301-12	14	7 x 24 x 36	0.086	2.18	12.90	19.20
301-15	12	7 x 37 x 36	0.102	2.59	20.00	29.76
301-18	10	7 x 59 x 36	0.130	3.30	31.85	47.39
301-21	8	7 x 95 x 36	0.166	4.22	51.28	76.30

Special Purpose Miniature Flexible Cables



CONDUCTOR: Stranded alloys of copper.
 JACKET: Rubber, Neoprene®, or polyurethane.
 USES: Intercommunication set cord, signal, and control cable.

Catalog No.	AWG Size	Total No. of Cond.	Nominal Diameter		Cable Type	Conductor Material	Weight	
			(in)	(mm)			(lbs / 1000 ft)	(kgs / km)
704-2 ²	24	3	0.212	5.38	WT 15 A/U	Tinned cadmium copper	30	45
704-3 ¹	24	4	0.280	7.11	WF 5 /U	Tinned cadmium copper	38	57
704-4 ²	24	4	0.212	5.38	WF 11 A/U	Tinned cadmium copper	30	45
704-5 ¹	24	4	0.300	7.62	WF 14 /U	Tinned cadmium copper	39	58
704-6 ¹	24	2	0.160	4.06	WD 34 /U	Tinned cadmium copper	14	21
1336-50 ¹	24	5	0.305	7.75	WM 85 /U	Tinned cadmium copper	43	64
1336-50B ²	24	5	0.289	7.34	WM 59 A/U	Tinned cadmium copper	51	76
1336-51 ²	24	6	0.252	6.40	WM 60 A/U	Tinned cadmium copper	38	57
708-5 ²	18 24	6 { 2 4	0.262	6.65	WM 69 B/U	Tinned cadmium copper	52	77
708-10 ²	18 24	7 { 2 5	0.280	7.11	WM 111 A/U	Tinned cadmium copper	56	83
708-11 ²	18 24	8 { 2 6	0.285	7.24	WM 70 B/U	Tinned cadmium copper	58	86

¹ MIL-C-5898D

² MIL-C-10392B Latest revision is MIL-C-10392C but this material is only available as Rev. B.

Neoprene® is a trademark of the DuPont de Nemours Co.

California

1959 East Cashdan Street, Rancho Dominguez, CA 90220
 (310) 609-1811 • (800) 326-0006 • FAX: (310) 609-1862
 E-Mail: salesrd@std-wire.com

Arizona

3120 West Thomas Road, Bldg. #801, Phoenix, AZ 85017
 (602) 269-2501 • (800) 325-6478 • FAX: (602) 278-7134
 E-Mail: salesphx@std-wire.com



Standard Wire & Cable Co.

Antenna Wire



- CONDUCTOR:** Solid hard drawn copper covered steel wire, except in the construction of W-120, where the conductor is 42 strands of 32 AWG (0.008") silicon bronze wire.
- CONSTRUCTION:** Manufactured to rigid government military specifications.
- USES:** Primarily used for antenna systems, however, they have many applications because of their high tensile strength.

Catalog No.	Military Type	AWG Size	Stranding	Dielectric	Nominal Diameter		Minimum Conductor Breaking Strength		Weight	
					(in)	(mm)	(lbs)	(kgs)	(lbs / 1000 ft)	(kgs / km)
801-175 ¹	6370-2	16	Solid	PE	0.183	4.65	250	113	20	30
801-176 ²	6370-1	16	Solid	PE	0.183	4.65	450	204	20	30
303-13F ³	W-106A	18	Solid	None	0.040	1.02	170	77.1	5	7
303-14D ⁴	W-120	16	42/32	None	0.062	1.57	200	90.7	8	12

¹MIL-W-6370C (Formerly WS-5C/U)
²MIL-W-6370C (Formerly WS-25/U)

³MIL-W-25136 (USAF)
⁴MIL-W-12995 (Sig.C)

Test Lead Wire Stanflex®



- CONSTRUCTION:** Finely stranded conductor for long service life in applications requiring repeated flexing such as instrument test leads, etc. Dielectric is free stripping rubber compound. Conforms to MIL-W-13169B.

Catalog No.	AWG Size	Stranding	Color	Working Voltage	Nominal Diameter		Weight	
					(in)	(mm)	(lbs / 1000 ft)	(kgs / km)
706-3A	18	65/36	Red	5,000	0.140	3.56	14.6	21.7
706-3B	18	65/36	Black	5,000	0.140	3.56	14.6	21.7

Stanflex® is a trademark of Standard Wire & Cable Co.

California

1959 East Cashdan Street, Rancho Dominguez, CA 90220
 (310) 609-1811 • (800) 326-0006 • FAX: (310) 609-1862
 E-Mail: salesrd@std-wire.com

Arizona

3120 West Thomas Road, Bldg. #801, Phoenix, AZ 85017
 (602) 269-2501 • (800) 325-6478 • FAX: (602) 278-7134
 E-Mail: salesphx@std-wire.com



Standard Wire & Cable Co.

MIL-W-8777C (ASG) MS 25471 (ASG)

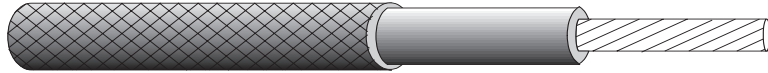

CONDUCTOR: Stranded silver-plated copper. TEMPERATURE: 200° C.
 CONSTRUCTION: Silicone rubber and fiber braid. COLOR: Natural (tan), white.
 VOLTAGE: 600 V

USES: A wire for high temperature use having good flexibility where abrasion, moisture, and fluid resistance are required.

Catalog No.	AWG Size	Stranding	Max. Bare Diameter		Max. Resistance @ 20° C (@ 68° F)		Maximum Diameter		Weight	
			(in)	(mm)	(ohms / 1000 ft)	(ohms / km)	(in)	(mm)	(lbs / 1000 ft)	(kgs / km)
1105-3	22	19/34	0.033	0.838	15.2	49.9	0.090	2.29	5.80	8.63
1105-6	20	19/32	0.041	1.04	9.42	30.9	0.100	2.54	7.80	11.6
1105-9	18	19/30	0.052	1.32	6.03	19.8	0.115	2.92	10.8	16.1
1105-12	16	19/29	0.060	1.52	4.72	15.5	0.130	3.30	13.5	20.1
1105-15	14	19/27	0.074	1.88	2.99	9.81	0.150	3.81	20.0	29.8
1105-18	12	19/25	0.093	2.36	1.88	6.17	0.170	4.32	29.0	43.2
1105-21	10	49/27	0.128	3.25	1.16	3.81	0.200	5.08	45.0	67.0
1105-24	8	133/29	0.176	4.47	0.700	2.30	0.255	6.48	72.0	107
1105-27	6	133/27	0.218	5.54	0.436	1.43	0.310	7.87	107	159
1105-30	4	133/25	0.272	6.91	0.274	0.899	0.370	9.40	165	246
1105-33	2	665/30	0.345	8.76	0.179	0.587	0.445	11.3	262	390
1105-36	1	817/30	0.384	9.75	0.144	0.472	0.495	12.6	317	472
1105-39	1/0	1,045/30	0.432	11.0	0.114	0.374	0.550	14.0	390	580
1105-46	2/0	1,330/30	0.490	12.4	0.090	0.295	0.610	15.5	500	744

California

1959 East Cashdan Street, Rancho Dominguez, CA 90220
 (310) 609-1811 • (800) 326-0006 • FAX: (310) 609-1862
 E-Mail: salesrd@std-wire.com

Arizona

3120 West Thomas Road, Bldg. #801, Phoenix, AZ 85017
 (602) 269-2501 • (800) 325-6478 • FAX: (602) 278-7134
 E-Mail: salesphx@std-wire.com



Standard Wire & Cable Co.

MS 27110 (ASG)

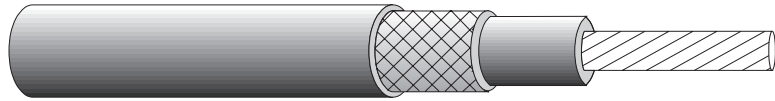

CONDUCTOR: Stranded silver-plated copper. **CONSTRUCTION:** Silicone rubber & fiber braid and extruded Teflon® fluorinated ethylene propylene (FEP).
VOLTAGE: 600 V
TEMPERATURE: 200° C. **COLOR:** Natural (tan).
USES: Silicone insulated Teflon® jacketed wire for high temperature use having good flexibility and providing excellent barrier against solvents, moisture, flame, and fungus.

Catalog No.	AWG Size	Stranding	Max. Resistance @ 20° C (@ 68° F)		Nominal Diameter		Weight	
			(ohms / 1000 ft)	(ohms / km)	(in)	(mm)	(lbs / 1000 ft)	(kgs / km)
1106-4	22	19/34	15.2	49.9	0.086	2.18	7.10	10.6
1106-7	20	19/32	9.42	30.9	0.096	2.44	9.00	13.4
1106-10	18	19/30	6.03	19.8	0.108	2.74	12.1	18.0
1106-13	16	19/29	4.72	15.5	0.116	2.95	14.3	21.3
1106-16	14	19/27	2.99	9.81	0.141	3.58	21.5	32.0
1106-19	12	19/25	1.88	6.17	0.160	4.06	30.5	45.4
1106-22	10	49/27	1.16	3.81	0.194	4.93	48.0	71.4
1106-25	8	133/29	0.700	2.30	0.243	6.17	75.0	112
1106-28	6	133/27	0.436	1.43	0.292	7.42	114	170
1106-31	4	133/25	0.274	0.899	0.357	9.07	173	257

Teflon® is a trademark of the DuPont de Nemours Co.

California

1959 East Cashdan Street, Rancho Dominguez, CA 90220
 (310) 609-1811 • (800) 326-0006 • FAX: (310) 609-1862
 E-Mail: salesrd@std-wire.com

Arizona

3120 West Thomas Road, Bldg. #801, Phoenix, AZ 85017
 (602) 269-2501 • (800) 325-6478 • FAX: (602) 278-7134
 E-Mail: salesphx@std-wire.com



Standard Wire & Cable Co.

MIL-W-25038/1

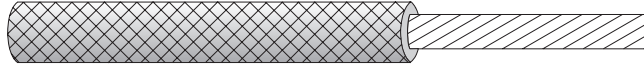

CONDUCTOR: 27% nickel-coated copper. INSULATION: Inorganic dielectric, PTFE/
 JACKET: Teflon® glass braid or fused PTFE polyimide composite fluid/
 tape wrapped. mechanical barrier.
 TEMPERATURE: 260° C. VOLTAGE: 600 V

USES: Fire resistant high temperature wire where resistance to moisture, abrasion, oils, and fluids is required. High insulation resistance for short intervals (15 minutes) when exposed to open flame of 1093°C (2000° F) .

Catalog No.	AWG Size	Stranding	Max. Resistance @ 20° C (@ 68° F)		Diameter (minimum - maximum)				Weight Maximum	
			(ohms / 1000 ft)	(ohms / km)	(in)	(mm)	(lbs / 1000 ft)	(kgs / km)		
1104-2	22	19/34	23.7	77.8	0.100	0.116	2.54	2.95	10	15
1104-6	20	19/32	14.6	47.9	0.109	0.125	2.77	3.18	12	18
1104-10	18	19/30	9.14	30.0	0.119	0.135	3.02	3.43	15	22
1104-14	16	19/29	6.85	22.5	0.127	0.147	3.23	3.73	19	28
1104-18	14	19/27	4.32	14.2	0.150	0.170	3.81	4.32	25	37
1104-22	12	19/25	2.78	9.12	0.165	0.185	4.19	4.70	35	52
1104-26	10	49/27	1.68	5.51	0.210	0.230	5.33	5.84	55	82
1104-30	8	133/29	0.936	3.07	0.256	0.280	6.50	7.11	85	126
1104-34	6	133/27	0.591	1.94	0.318	0.342	8.08	8.69	127	189
1104-38	4	133/25	0.375	1.23	0.383	0.407	9.73	10.3	192	286
1104-42	2	665/30	0.241	0.791	0.460	0.484	11.7	12.3	291	433
1104-46	1	817/30	0.196	0.643	0.497	0.533	12.6	13.5	347	516
1104-50	1/0	1,045/30	0.153	0.502	0.537	0.573	13.6	14.6	415	618
1104-60	2/0	1,330/30	0.120	0.394	0.595	0.635	15.1	16.1	520	774
1104-70	3/0	1,672/30	0.096	0.315	0.660	0.700	16.8	17.8	648	964
1104-80	4/0	2,109/30	0.077	0.253	0.730	0.770	18.5	19.6	793	1,180

Also Available: MS 27125 (USAF).

MIL-W-25038/3



CONDUCTOR: 27% nickel-coated copper (AWG 12-18); 27% nickel-coated high strength copper (AWG 20-22). JACKET: Fused PTFE tape wrapped.

Catalog No.	AWG Size	Stranding	Max. Resistance @ 20° C (@ 68° F)		Diameter (minimum - maximum)				Weight Maximum	
			(ohms / 1000 ft)	(ohms / km)	(in)	(mm)	(lbs / 1000 ft)	(kgs / km)		
1104-2A	22	19/34	23.7	77.8	0.040	0.054	1.02	1.37	4.15	6.18
1104-6A	20	19/32	15.3	50.1	0.048	0.083	1.22	2.11	9.0	13
1104-10A	18	19/30	8.50	27.9	0.065	0.097	1.65	2.46	10.5	15.6
1104-14A	16	19/29	6.66	21.9	0.068	0.103	1.73	2.62	13.5	20.1
1104-16A	14	19/27	4.32	14.2	0.097	0.123	2.46	3.12	19.5	29.0
1104-22A	12	19/25	2.78	9.12	0.100	0.142	2.54	3.61	28.0	41.7

Teflon® is a trademark of the DuPont de Nemours Co.

California

1959 East Cashdan Street, Rancho Dominguez, CA 90220
 (310) 609-1811 • (800) 326-0006 • FAX: (310) 609-1862
 E-Mail: salesrd@std-wire.com

Arizona

3120 West Thomas Road, Bldg. #801, Phoenix, AZ 85017
 (602) 269-2501 • (800) 325-6478 • FAX: (602) 278-7134
 E-Mail: salesphx@std-wire.com



Standard Wire & Cable Co.

MIL-W-22759



Class 1 200° C MIL-W-22759/1

CONDUCTOR: Stranded silver-plated copper.
 INSULATION: Teflon® tape and Teflon® coated glass tape; a braid of Teflon® coated fiberglass; finish of Teflon® resin.
 COLOR: White.
 VOLTS: 600 V

Class 2 260° C MIL-W-22759/2

CONDUCTOR: Stranded nickel-plated copper.
 INSULATION: Teflon® tape and Teflon® coated glass tape; a braid of Teflon® coated fiberglass; finish of Teflon® resin.
 COLOR: White.
 VOLTS: 600 V

USES: Heat and abrasion resistant. Excellent flame and fungus resistance.

Class 1 Catalog No.	Class 2 Catalog No.	AWG Size	Stranding	Max. Resistance* @ 20° C (@ 68° F)		Diameter (minimum - maximum)		Weight Maximum	
				(ohms / 1000 ft)	(ohms / km)	(in)	(mm)	(lbs / 1000 ft)	(kgs / km)
1103-10B	1103-10C	22	19/34	15.1	49.5	0.080 - 0.088	2.03 - 2.24	7.5	11
1103-17B	1103-17C	20	19/32	9.19	30.2	0.090 - 0.098	2.29 - 2.49	9.5	14
1103-23B	1103-23C	18	19/30	5.79	19.0	0.100 - 0.110	2.54 - 2.79	13.0	19.3
1103-30B	1103-30C	16	19/29	4.52	14.8	0.115 - 0.125	2.92 - 3.18	16.5	24.6
1103-34B	1103-34C	14	19/27	2.88	9.45	0.133 - 0.143	3.38 - 3.63	23.0	34.2
1103-39B	1103-39C	12	37/28	1.90	6.23	0.152 - 0.162	3.86 - 4.11	32.1	47.8
1103-46B	1103-46C	10	37/26	1.19	3.90	0.174 - 0.188	4.42 - 4.78	47.0	69.9
1103-51B	1103-51C	8	133/29	0.658	2.16	0.241 - 0.255	6.12 - 6.48	82.0	122
1103-58B	1103-58C	6	133/27	0.418	1.37	0.283 - 0.303	7.19 - 7.70	122	182
1103-63B	1103-63C	4	133/25	0.264	0.866	0.340 - 0.370	8.64 - 9.40	180	268
1103-70B	1103-70C	2	665/30	0.170	0.558	0.405 - 0.435	10.3 - 11.0	275	409
1103-75B	1103-75C	1	817/30	0.139	0.456	0.455 - 0.485	11.6 - 12.3	348	518
1103-79B	1103-79C	1/0	1,045/30	0.108	0.354	0.495 - 0.535	12.6 - 13.6	429	638
1103-83B	1103-83C	2/0	1,330/30	0.085	0.279	0.555 - 0.595	14.1 - 15.1	542	806
1103-87B	1103-87C	3/0	1,665/30	0.068	0.223	0.620 - 0.660	15.7 - 16.8	668	994
1103-91B	1103-91C	4/0	2,109/30	0.054	0.177	0.690 - 0.730	17.5 - 18.5	835	1,242

Teflon® is a trademark of the DuPont de Nemours Co.

* Maximum resistance for MIL-W-22759/1. For MIL-W-22759/2 see military specification.

California

1959 East Cashdan Street, Rancho Dominguez, CA 90220
 (310) 609-1811 • (800) 326-0006 • FAX: (310) 609-1862
 E-Mail: salesrd@std-wire.com

Arizona

3120 West Thomas Road, Bldg. #801, Phoenix, AZ 85017
 (602) 269-2501 • (800) 325-6478 • FAX: (602) 278-7134
 E-Mail: salesphx@std-wire.com



Standard Wire & Cable Co.

MIL-W-22759/3

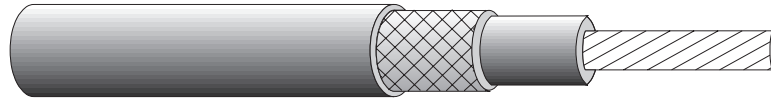

CONDUCTOR: Stranded nickel-coated copper. **CONSTRUCTION:** Fused Teflon® tape, Teflon® coated glass braid, and Teflon® skived tapes, FEP.
VOLTAGE: 600 V
TEMPERATURE: -55° C to 260° C. **COLOR:** White
USES: Excellent resistance to fluids, oils, solvents, moisture, and fungus. An excellent wire when great thermal stability is required.

Catalog No.	AWG Size	Stranding	Max. Resistance @ 20° C (@ 68° F)		Nominal Thickness of FEP Jacket		Diameter (minimum - maximum)		Weight Maximum	
			(ohms / 1000 ft)	(ohms / km)	(in)	(mm)	(in)	(mm)	(lbs / 1000 ft)	(kgs / km)
1103-10D	22	19/34	16.0	52.5	0.009	0.229	0.071 - 0.077	1.80 - 1.96	5.90	8.78
1103-17D	20	19/32	9.77	32.1	0.009	0.229	0.079 - 0.085	2.01 - 2.16	7.90	11.8
1103-23D	18	19/30	6.10	20.0	0.010	0.254	0.092 - 0.098	2.34 - 2.49	11.0	16.4
1103-30D	16	19/29	4.76	15.6	0.010	0.254	0.099 - 0.107	2.51 - 2.72	13.6	20.2
1103-34D	14	19/27	3.00	9.84	0.010	0.254	0.112 - 0.120	2.84 - 3.05	18.5	27.5
1103-39D	12	37/28	1.98	6.50	0.010	0.254	0.129 - 0.137	3.28 - 3.48	26.6	39.6
1103-46D	10	37/26	1.24	4.07	0.010	0.254	0.158 - 0.170	4.01 - 4.32	41.5	61.8
1103-51D	8	133/29	0.694	2.28	0.010	0.254	0.228 - 0.242	5.79 - 6.15	77.4	115
1103-58D	6	133/27	0.436	1.43	0.010	0.254	0.272 - 0.292	6.91 - 7.42	115	171
1103-63D	4	133/25	0.275	0.902	0.012	0.305	0.336 - 0.366	8.53 - 9.30	184	274
1103-70D	2	665/30	0.177	0.581	0.012	0.305	0.415 - 0.445	10.5 - 11.3	281	418
1103-75D	1	817/30	0.144	0.472	0.014	0.356	0.465 - 0.495	11.8 - 12.6	358	533
1103-79D	1/0	1,045/30	0.113	0.371	0.014	0.356	0.500 - 0.550	12.7 - 14.0	436	649
1103-83D	2/0	1,330/30	0.089	0.292	0.014	0.356	0.560 - 0.610	14.2 - 15.5	554	824

Teflon® is a trademark of the DuPont de Nemours Co.

California

1959 East Cashdan Street, Rancho Dominguez, CA 90220
 (310) 609-1811 • (800) 326-0006 • FAX: (310) 609-1862
 E-Mail: salesrd@std-wire.com

Arizona

3120 West Thomas Road, Bldg. #801, Phoenix, AZ 85017
 (602) 269-2501 • (800) 325-6478 • FAX: (602) 278-7134
 E-Mail: salesphx@std-wire.com



Standard Wire & Cable Co.

MIL-W-22759/4 MS 90294

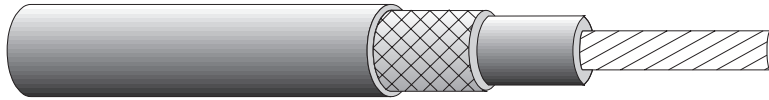

CONDUCTOR: Stranded silver-plated copper. CONSTRUCTION: Teflon® tapes, Teflon® coated fiberglass tapes, and Teflon® coated fiberglass braid, FEP.
 VOLTAGE: 600 V
 TEMPERATURE: -55° C to 200° C.

USES: Excellent resistance to fluids, oils, solvents, moisture, and fungus. An excellent wire when great thermal stability is required.

Catalog No.	AWG Size	Stranding	Max. Resistance @ 20° C (@ 68° F)		Nominal Thickness of FEP Jacket		Diameter (minimum - maximum)		Weight Maximum	
			(ohms / 1000 ft)	(ohms / km)	(in)	(mm)	(in)	(mm)	(lbs / 1000 ft)	(kgs / km)
1107-10B	22	19/34	15.1	49.5	0.009	0.229	0.071 - 0.077	1.80 - 1.96	5.90	8.78
1107-17B	20	19/32	9.19	30.2	0.009	0.229	0.079 - 0.085	2.01 - 2.16	7.90	11.8
1107-23B	18	19/30	5.79	19.0	0.010	0.254	0.092 - 0.098	2.34 - 2.49	11.0	16.4
1107-30B	16	19/29	4.52	14.8	0.010	0.254	0.099 - 0.107	2.51 - 2.72	13.6	20.2
1107-34B	14	19/27	2.88	9.45	0.010	0.254	0.112 - 0.120	2.84 - 3.05	18.5	27.5
1107-39B	12	37/28	1.90	6.23	0.010	0.254	0.129 - 0.137	3.28 - 3.48	26.6	39.6
1107-46B	10	37/26	1.19	3.90	0.010	0.254	0.158 - 0.170	4.01 - 4.32	41.5	61.8
1107-51B	8	133/29	0.658	2.16	0.010	0.254	0.228 - 0.242	5.79 - 6.15	77.4	115
1107-58B	6	133/27	0.418	1.37	0.010	0.254	0.272 - 0.292	6.91 - 7.42	115	171
1107-63B	4	133/25	0.264	0.866	0.012	0.305	0.336 - 0.366	8.53 - 9.30	184	274
1107-70B	2	665/30	0.170	0.558	0.012	0.305	0.415 - 0.445	10.5 - 11.3	281	418
1107-75B	1	817/30	0.139	0.456	0.014	0.356	0.465 - 0.495	11.8 - 12.6	358	533
1107-79B	1/0	1,045/30	0.108	0.354	0.014	0.356	0.500 - 0.550	12.7 - 14.0	436	649
1107-83B	2/0	1,330/30	0.085	0.279	0.014	0.356	0.560 - 0.610	14.2 - 15.5	554	824

Teflon® is a trademark of the DuPont de Nemours Co.

California

1959 East Cashdan Street, Rancho Dominguez, CA 90220
 (310) 609-1811 • (800) 326-0006 • FAX: (310) 609-1862
 E-Mail: salesrd@std-wire.com

Arizona

3120 West Thomas Road, Bldg. #801, Phoenix, AZ 85017
 (602) 269-2501 • (800) 325-6478 • FAX: (602) 278-7134
 E-Mail: salesphx@std-wire.com



Standard Wire & Cable Co.

MIL-W-22759/5



CONDUCTOR: Stranded silver-plated copper. INSULATION: TFE, reinforced with abrasion resistant mineral fillers.
 VOLTAGE: 600 V
 TEMPERATURE: -55° C to 200° C.
 USES: Wire for high temperature use having good flexibility. For use where abrasion resistance is required.

Catalog No.	AWG Size	Stranding	Max. Resistance @ 20° C (@ 68° F)		Diameter (minimum - maximum)		Weight Maximum	
			(ohms / 1000 ft)	(ohms / km)	(in)	(mm)	(lbs / 1000 ft)	(kgs / km)
1165-32	24	19/36	24.3	79.7	0.070 - 0.080	1.78 - 2.03	6.00	8.93
1165-34	22	19/34	15.1	49.5	0.080 - 0.090	2.03 - 2.29	8.00	11.9
1165-39	20	19/32	9.19	30.2	0.090 - 0.100	2.29 - 2.54	10.0	14.9
1165-44	18	19/30	5.79	19.0	0.105 - 0.115	2.67 - 2.92	14.0	20.8
1165-49	16	19/29	4.52	14.8	0.120 - 0.130	3.05 - 3.30	18.0	26.8
1165-54	14	19/27	2.88	9.45	0.136 - 0.150	3.45 - 3.81	25.0	37.2
1165-60	12	19/25	1.81	5.94	0.153 - 0.167	3.89 - 4.24	34.5	51.3
1165-64	10	37/26	1.19	3.90	0.172 - 0.186	4.37 - 4.72	48.0	71.4
1165-69	8	133/29	0.658	2.16	0.241 - 0.255	6.12 - 6.48	83.7	125
1165-74	6	133/27	0.418	1.37	0.290 - 0.310	7.37 - 7.87	126	187
1165-79	4	133/25	0.264	0.866	0.340 - 0.370	8.64 - 9.40	188	280

MIL-W-22759/6



CONDUCTOR: Stranded nickel-plated copper. INSULATION: TFE, reinforced with abrasion resistant mineral fillers.
 VOLTAGE: 600 V
 TEMPERATURE: -55° C to 260° C.
 USES: Wire for high temperature use having good flexibility. For use where abrasion resistance is required.

Catalog No.	AWG Size	Stranding	Max. Resistance @ 20° C (@ 68° F)		Diameter (minimum - maximum)		Weight Maximum	
			(ohms / 1000 ft)	(ohms / km)	(in)	(mm)	(lbs / 1000 ft)	(kgs / km)
1166-32	24	19/36	25.9	85.0	0.070 - 0.080	1.78 - 2.03	6.00	8.93
1166-34	22	19/34	16.0	52.5	0.080 - 0.090	2.03 - 2.29	8.00	11.9
1166-39	20	19/32	9.77	32.1	0.090 - 0.100	2.29 - 2.54	10.0	14.9
1166-44	18	19/30	6.10	20.0	0.105 - 0.115	2.67 - 2.92	14.0	20.8
1166-49	16	19/29	4.76	15.6	0.120 - 0.130	3.05 - 3.30	18.0	26.8
1166-54	14	19/27	3.00	9.84	0.136 - 0.150	3.45 - 3.81	25.0	37.2
1166-60	12	19/25	1.89	6.20	0.153 - 0.167	3.89 - 4.24	34.5	51.3
1166-64	10	37/26	1.24	4.07	0.172 - 0.186	4.37 - 4.72	48.0	71.4
1166-69	8	133/29	0.694	2.28	0.241 - 0.255	6.12 - 6.48	83.7	125
1166-74	6	133/27	0.436	1.43	0.290 - 0.310	7.37 - 7.87	127	189
1166-79	4	133/25	0.275	0.902	0.340 - 0.370	8.64 - 9.40	190	283

California

1959 East Cashdan Street, Rancho Dominguez, CA 90220
 (310) 609-1811 • (800) 326-0006 • FAX: (310) 609-1862
 E-Mail: salesrd@std-wire.com

Arizona

3120 West Thomas Road, Bldg. #801, Phoenix, AZ 85017
 (602) 269-2501 • (800) 325-6478 • FAX: (602) 278-7134
 E-Mail: salesphx@std-wire.com



Standard Wire & Cable Co.

MIL-W-22759/7



CONDUCTOR: Stranded silver-plated copper. INSULATION: TFE, reinforced with abrasion resistant mineral fillers.
 VOLTAGE: 600 V
 TEMPERATURE: -55° C to 200° C.
 USES: Wire for high temperature use having good flexibility, medium weight. For use where abrasion resistance is required.

Catalog No.	AWG Size	Stranding	Max. Resistance @ 20° C (@ 68° F)		Diameter (minimum - maximum)		Weight Maximum	
			(ohms / 1000 ft)	(ohms / km)	(in)	(mm)	(lbs / 1000 ft)	(kgs / km)
1167-32	24	19/36	24.3	79.7	0.060 - 0.064	1.52 - 1.63	4.3	6.4
1167-34	22	19/34	15.1	49.5	0.071 - 0.075	1.80 - 1.91	6.0	8.9
1167-39	20	19/32	9.19	30.2	0.080 - 0.084	2.03 - 2.13	8.1	12.1
1167-44	18	19/30	5.79	19.0	0.090 - 0.094	2.29 - 2.39	11.0	16.4
1167-49	16	19/29	4.52	14.8	0.099 - 0.105	2.51 - 2.67	13.8	20.5
1167-54	14	19/27	2.88	9.45	0.112 - 0.118	2.84 - 3.00	18.6	27.7
1167-60	12	19/25	1.81	5.94	0.131 - 0.137	3.33 - 3.48	28.5	42.4
1167-64	10	37/26	1.19	3.90	0.154 - 0.162	3.91 - 4.11	41.8	62.2
1167-69	8	133/29	0.658	2.16	0.215 - 0.225	5.46 - 5.72	73.1	109
1167-74	6	133/27	0.418	1.37	0.264 - 0.276	6.71 - 7.01	111	165
1167-79	4	133/25	0.264	0.866	0.321 - 0.335	8.15 - 8.51	169	251

MIL-W-22759/8



CONDUCTOR: Stranded nickel-plated copper. INSULATION: TFE, reinforced with abrasion resistant mineral fillers.
 VOLTAGE: 600 V
 TEMPERATURE: -55° C to 260° C.
 USES: Wire for high temperature use having good flexibility, medium weight. For use where abrasion resistance is required.

Catalog No.	AWG Size	Stranding	Max. Resistance @ 20° C (@ 68° F)		Diameter (minimum - maximum)		Weight Maximum	
			(ohms / 1000 ft)	(ohms / km)	(in)	(mm)	(lbs / 1000 ft)	(kgs / km)
1168-32	24	19/36	25.9	85.0	0.060 - 0.064	1.52 - 1.63	4.3	6.4
1168-34	22	19/34	16.0	52.5	0.071 - 0.075	1.80 - 1.91	6.0	8.9
1168-39	20	19/32	9.77	32.1	0.080 - 0.084	2.03 - 2.13	8.1	12.1
1168-44	18	19/30	6.10	20.0	0.090 - 0.094	2.29 - 2.39	11.0	16.4
1168-49	16	19/29	4.76	15.6	0.099 - 0.105	2.51 - 2.67	13.8	20.5
1168-54	14	19/27	3.00	9.84	0.112 - 0.118	2.84 - 3.00	18.6	27.7
1168-60	12	19/25	1.89	6.20	0.131 - 0.137	3.33 - 3.48	28.5	42.4
1168-64	10	37/26	1.24	4.07	0.154 - 0.162	3.91 - 4.11	41.8	62.2
1168-69	8	133/29	0.694	2.28	0.215 - 0.225	5.46 - 5.72	73.1	109
1168-74	6	133/27	0.436	1.43	0.264 - 0.276	6.71 - 7.01	113	168
1168-79	4	133/25	0.275	0.902	0.321 - 0.335	8.15 - 8.51	173	257

California

1959 East Cashdan Street, Rancho Dominguez, CA 90220
 (310) 609-1811 • (800) 326-0006 • FAX: (310) 609-1862
 E-Mail: salesrd@std-wire.com

Arizona

3120 West Thomas Road, Bldg. #801, Phoenix, AZ 85017
 (602) 269-2501 • (800) 325-6478 • FAX: (602) 278-7134
 E-Mail: salesphx@std-wire.com



Standard Wire & Cable Co.

MIL-W-22759/9



CONDUCTOR: Stranded silver-plated copper. TEMPERATURE: -55° C to 200° C.
 VOLTAGE: 1000 V INSULATION: PTFE.
 USES: Wire where resistance to high temperatures and high reliability are required. For use where smoke emission, overload stability, and/or flammability may be a problem.

Catalog No.	AWG Size	Stranding	Max. Resistance @ 20° C (@ 68° F)		Diameter (minimum - maximum)		Weight Maximum	
			(ohms / 1000 ft)	(ohms / km)	(in)	(mm)	(lbs / 1000 ft)	(kgs / km)
M22759/9-28-*	28	7/36	67.9	223	0.041 - 0.045	1.04 - 1.14	1.90	2.83
M22759/9-26-*	26	19/38	42.2	138	0.046 - 0.050	1.17 - 1.27	2.57	3.82
M22759/9-24-*	24	19/36	25.9	85.0	0.051 - 0.055	1.30 - 1.40	3.33	4.96
M22759/9-22-*	22	19/34	16.0	52.5	0.058 - 0.062	1.47 - 1.57	4.60	6.84
M22759/9-20-*	20	19/32	9.77	32.1	0.066 - 0.070	1.68 - 1.78	6.40	9.52
M22759/9-18-*	18	19/30	6.10	20.0	0.076 - 0.080	1.93 - 2.03	9.10	13.5
M22759/9-16-*	16	19/29	4.76	15.6	0.083 - 0.087	2.11 - 2.21	11.0	16.4
M22759/9-14-*	14	19/27	3.00	9.84	0.097 - 0.103	2.46 - 2.62	16.4	24.4
M22759/9-12-*	12	19/25	1.89	6.20	0.116 - 0.124	2.95 - 3.15	25.3	37.6
M22759/9-10-*	10	37/26	1.24	4.07	0.137 - 0.145	3.48 - 3.68	38.2	56.8
M22759/9-8-*	8	133/29	0.694	2.28	0.202 - 0.212	5.13 - 5.38	68.8	102

MIL-W-22759/10



CONDUCTOR: Stranded nickel-plated copper. TEMPERATURE: -55° C to 260° C.
 VOLTAGE: 1000 V INSULATION: PTFE.
 USES: Wire where resistance to high temperatures and high reliability are required. For use where smoke emission, overload stability, and/or flammability may be a problem.

Catalog No.	AWG Size	Stranding	Max. Resistance @ 20° C (@ 68° F)		Diameter (minimum - maximum)		Weight Maximum	
			(ohms / 1000 ft)	(ohms / km)	(in)	(mm)	(lbs / 1000 ft)	(kgs / km)
M22759/10-28-*	28	7/36	67.9	223	0.041 - 0.045	1.04 - 1.14	1.90	2.83
M22759/10-26-*	26	19/38	42.2	138	0.046 - 0.050	1.17 - 1.27	2.57	3.82
M22759/10-24-*	24	19/36	25.9	85.0	0.051 - 0.055	1.30 - 1.40	3.33	4.96
M22759/10-22-*	22	19/34	16.0	52.5	0.058 - 0.062	1.47 - 1.57	4.60	6.84
M22759/10-20-*	20	19/32	9.77	32.1	0.066 - 0.070	1.68 - 1.78	6.40	9.52
M22759/10-18-*	18	19/30	6.10	20.0	0.076 - 0.080	1.93 - 2.03	9.10	13.5
M22759/10-16-*	16	19/29	4.76	15.6	0.083 - 0.087	2.11 - 2.21	11.0	16.4
M22759/10-14-*	14	19/27	3.00	9.84	0.097 - 0.103	2.46 - 2.62	16.4	24.4
M22759/10-12-*	12	19/25	1.89	6.20	0.116 - 0.124	2.95 - 3.15	25.3	37.6
M22759/10-10-*	10	37/26	1.24	4.07	0.137 - 0.145	3.48 - 3.68	38.2	56.8
M22759/10-8-*	8	133/29	0.694	2.28	0.202 - 0.212	5.13 - 5.38	68.8	102

* The asterisks in the part number columns are to be replaced by numeric color code designations in accordance with MIL-STD-681D as shown in Color Code Chart No. 6 on page 33.

California

1959 East Cashdan Street, Rancho Dominguez, CA 90220
 (310) 609-1811 • (800) 326-0006 • FAX: (310) 609-1862
 E-Mail: salesrd@std-wire.com

Arizona

3120 West Thomas Road, Bldg. #801, Phoenix, AZ 85017
 (602) 269-2501 • (800) 325-6478 • FAX: (602) 278-7134
 E-Mail: salesphx@std-wire.com



Standard Wire & Cable Co.

MIL-W-22759/11

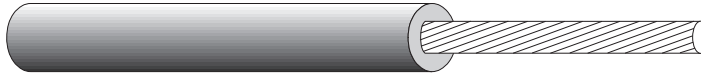

CONDUCTOR: Stranded silver-plated copper. TEMPERATURE: -55° C to 200° C.
 VOLTAGE: 600 V INSULATION: PTFE.
 USES: Wire where resistance to high temperatures and high reliability are required. For use where smoke emission, overload stability, and/or flammability may be a problem.

Catalog No.	AWG Size	Stranding	Max. Resistance @ 20° C (@ 68° F)		Diameter (minimum - maximum)		Weight Maximum	
			(ohms / 1000 ft)	(ohms / km)	(in)	(mm)	(lbs / 1000 ft)	(kgs / km)
M22759/11-28-*	28	7/36	63.8	209	0.031 - 0.035	0.787 - 0.889	1.36	2.02
M22759/11-26-*	26	19/38	38.4	126	0.036 - 0.040	0.914 - 1.02	1.90	2.83
M22759/11-24-*	24	19/36	24.3	79.7	0.041 - 0.045	1.04 - 1.14	2.58	3.84
M22759/11-22-*	22	19/34	15.1	49.5	0.047 - 0.051	1.19 - 1.30	3.72	5.54
M22759/11-20-*	20	19/32	9.19	30.2	0.056 - 0.060	1.42 - 1.52	5.43	8.08
M22759/11-18-*	18	19/30	5.79	19.0	0.066 - 0.070	1.68 - 1.78	8.14	12.1
M22759/11-16-*	16	19/29	4.52	14.8	0.073 - 0.077	1.85 - 1.96	10.0	14.9
M22759/11-14-*	14	19/27	2.88	9.45	0.088 - 0.092	2.24 - 2.34	15.1	22.5
M22759/11-12-*	12	19/25	1.81	5.94	0.108 - 0.114	2.74 - 2.90	24.1	35.9
M22759/11-10-*	10	37/26	1.19	3.90	0.135 - 0.143	3.43 - 3.63	37.8	56.2
M22759/11-8-*	8	133/29	0.658	2.16	0.198 - 0.206	5.03 - 5.23	65.5	97.5

MIL-W-22759/12



CONDUCTOR: Stranded nickel-plated copper. TEMPERATURE: -55° C to 260° C.
 VOLTAGE: 600 V INSULATION: PTFE.
 USES: Wire where resistance to high temperatures and high reliability are required. For use where smoke emission, overload stability, and/or flammability may be a problem.

Catalog No.	AWG Size	Stranding	Max. Resistance @ 20° C (@ 68° F)		Diameter (minimum - maximum)		Weight Maximum	
			(ohms / 1000 ft)	(ohms / km)	(in)	(mm)	(lbs / 1000 ft)	(kgs / km)
M22759/12-28-*	28	7/36	67.9	223	0.031 - 0.035	0.787 - 0.889	1.36	2.02
M22759/12-26-*	26	19/38	42.2	138	0.036 - 0.040	0.914 - 1.02	1.90	2.83
M22759/12-24-*	24	19/36	25.9	85.0	0.041 - 0.045	1.04 - 1.14	2.58	3.84
M22759/12-22-*	22	19/34	16.0	52.5	0.047 - 0.051	1.19 - 1.30	3.72	5.54
M22759/12-20-*	20	19/32	9.77	32.1	0.056 - 0.060	1.42 - 1.52	5.43	8.08
M22759/12-18-*	18	19/30	6.10	20.0	0.066 - 0.070	1.68 - 1.78	8.14	12.1
M22759/12-16-*	16	19/29	4.76	15.6	0.073 - 0.077	1.85 - 1.96	10.0	14.9
M22759/12-14-*	14	19/27	3.00	9.84	0.088 - 0.092	2.24 - 2.34	15.6	23.2
M22759/12-12-*	12	19/25	1.89	6.20	0.108 - 0.114	2.74 - 2.90	24.4	36.3
M22759/12-10-*	10	37/26	1.24	4.07	0.135 - 0.143	3.43 - 3.63	39.0	58.0
M22759/12-8-*	8	133/29	0.694	2.28	0.200 - 0.208	5.08 - 5.28	67.0	99.7

* The asterisks in the part number columns are to be replaced by numeric color code designations in accordance with MIL-STD-681D as shown in Color Code Chart No. 6 on page 33.

California

1959 East Cashdan Street, Rancho Dominguez, CA 90220
 (310) 609-1811 • (800) 326-0006 • FAX: (310) 609-1862
 E-Mail: salesrd@std-wire.com

Arizona

3120 West Thomas Road, Bldg. #801, Phoenix, AZ 85017
 (602) 269-2501 • (800) 325-6478 • FAX: (602) 278-7134
 E-Mail: salesphx@std-wire.com



Standard Wire & Cable Co.

MIL-W-22759/16



CONDUCTOR: Stranded tinned copper.
 VOLTAGE: 600 V
 USES: Rugged with very good dielectric properties, medium weight. For use under conditions

TEMPERATURE: -55° C to 150° C.
 INSULATION: ETFE Tefzel®.

requiring very good thermal/cryogenic performance. Tefzel® is considered to be "self-extinguishing" and/or "nonburning" in both horizontal and vertical flammability tests.

Catalog No.	AWG Size	Stranding	Max. Resistance @ 20° C (@ 68° F)		Diameter (minimum - maximum)		Weight Maximum	
			(ohms / 1000 ft)	(ohms / km)	(in)	(mm)	(lbs / 1000 ft)	(kgs / km)
1090-30	24	19/36	26.2	86.0	0.043 - 0.047	1.09 - 1.19	2.57	3.82
1090-35	22	19/34	16.2	53.1	0.050 - 0.054	1.27 - 1.37	3.68	5.48
1090-40	20	19/32	9.88	32.4	0.058 - 0.062	1.47 - 1.57	5.36	7.98
1090-45	18	19/30	6.23	20.4	0.069 - 0.073	1.75 - 1.85	7.89	11.7
1090-50	16	19/29	4.81	15.8	0.077 - 0.081	1.96 - 2.06	9.95	14.8
1090-55	14	19/27	3.06	10.0	0.091 - 0.095	2.31 - 2.41	14.9	22.2
1090-60	12	37/28	2.02	6.63	0.111 - 0.117	2.82 - 2.97	22.6	33.6
1090-65	10	37/26	1.26	4.13	0.136 - 0.142	3.45 - 3.61	35.1	52.2
1090-70	8	133/29	0.701	2.30	0.196 - 0.202	4.98 - 5.13	63.5	94.5
1090-75	6	133/27	0.445	1.46	0.247 - 0.253	6.27 - 6.43	99.9	149
1090-80	4	133/25	0.280	0.92	0.308 - 0.316	7.82 - 8.03	157	234
1090-85	2	665/30	0.183	0.60	0.384 - 0.392	9.75 - 9.96	245	365
1090-90	1	817/30	0.149	0.49	0.426 - 0.436	10.8 - 11.1	314	467
1090-95	1/0	1,045/30	0.116	0.38	0.473 - 0.485	12.0 - 12.3	391	582
1090-100	2/0	1,330/30	0.091	0.30	0.539 - 0.553	13.7 - 14.0	504	750

MIL-W-22759/18



CONDUCTOR: Stranded tinned copper.
 VOLTAGE: 600 V
 USES: Rugged with very good dielectric properties, lightweight. For use under conditions

TEMPERATURE: -55° C to 150° C.
 INSULATION: ETFE Tefzel®.

requiring very good thermal/cryogenic performance. Tefzel® is considered to be "self-extinguishing" and/or "nonburning" in both horizontal and vertical flammability tests.

Catalog No.	AWG Size	Stranding	Max. Resistance @ 20° C (@ 68° F)		Diameter (minimum - maximum)		Weight Maximum	
			(ohms / 1000 ft)	(ohms / km)	(in)	(mm)	(lbs / 1000 ft)	(kgs / km)
1091-3	26	19/38	41.3	135	0.030 - 0.034	0.762 - 0.864	1.52	2.26
1091-5	24	19/36	26.2	86.0	0.034 - 0.038	0.864 - 0.965	2.12	3.15
1091-10	22	19/34	16.2	53.1	0.041 - 0.045	1.04 - 1.14	3.16	4.70
1091-15	20	19/32	9.88	32.4	0.049 - 0.053	1.24 - 1.35	4.76	7.08
1091-20	18	19/30	6.23	20.4	0.059 - 0.063	1.50 - 1.60	7.10	10.6
1091-25	16	19/29	4.81	15.8	0.068 - 0.072	1.73 - 1.83	9.14	13.6
1091-30	14	19/27	3.06	10.0	0.083 - 0.087	2.11 - 2.21	14.1	21.0
1091-45	12	37/28	2.02	6.63	0.104 - 0.110	2.64 - 2.79	21.6	32.1
1091-50	10	37/26	1.26	4.13	0.131 - 0.137	3.33 - 3.48	34.1	50.7

Tefzel® is a trademark of the DuPont de Nemours Co.

California

1959 East Cashdan Street, Rancho Dominguez, CA 90220
 (310) 609-1811 • (800) 326-0006 • FAX: (310) 609-1862
 E-Mail: salesrd@std-wire.com

Arizona

3120 West Thomas Road, Bldg. #801, Phoenix, AZ 85017
 (602) 269-2501 • (800) 325-6478 • FAX: (602) 278-7134
 E-Mail: salesphx@std-wire.com



Standard Wire & Cable Co.

MIL-W-22759/20



CONDUCTOR: Stranded silver-plated alloy. TEMPERATURE: -55° C to 200° C.
 VOLTAGE: 1000 V INSULATION: PTFE.
 USES: Wire where resistance to high temperatures, high breaking strength, high reliability, and flexibility are required. For use where smoke emission, overload stability, and/or flammability may be a problem.

Military Part No.	AWG Size	Stranding	Max. Resistance @ 20° C (@ 68° F)		Diameter (minimum - maximum)		Minimum Breaking Strength		Weight Maximum	
			(ohms / 1000 ft)	(ohms / km)	(in)	(mm)	(lbs)	(kg)	(lbs / 1000 ft)	(kgs / km)
M22759/20-28*	28	7/36	74.4	244	0.041 - 0.045	1.04 - 1.14	8.16	3.70	1.91	2.84
M22759/20-26*	26	19/38	44.8	147	0.046 - 0.050	1.17 - 1.27	14.2	6.44	2.57	3.82
M22759/20-24*	24	19/36	28.4	93.2	0.051 - 0.055	1.30 - 1.40	22.4	10.2	3.35	4.98
M22759/20-22*	22	19/34	17.5	57.4	0.058 - 0.062	1.47 - 1.57	35.8	16.2	4.59	6.83
M22759/20-20*	20	19/32	10.7	35.1	0.066 - 0.070	1.68 - 1.78	58.1	26.4	6.41	9.54

MIL-W-22759/21



CONDUCTOR: Stranded nickel-plated alloy. TEMPERATURE: -55° C to 260° C.
 VOLTAGE: 1000 V INSULATION: PTFE.
 USES: Wire where resistance to high temperatures, high breaking strength, high reliability, and flexibility are required. For use where smoke emission, overload stability, and/or flammability may be a problem.

Military Part No.	AWG Size	Stranding	Max. Resistance @ 20° C (@ 68° F)		Diameter (minimum - maximum)		Minimum Breaking Strength		Weight Maximum	
			(ohms / 1000 ft)	(ohms / km)	(in)	(mm)	(lbs)	(kg)	(lbs / 1000 ft)	(kgs / km)
M22759/21-28*	28	7/36	79.0	259	0.041 - 0.045	1.04 - 1.14	8.16	3.70	1.93	2.87
M22759/21-26*	26	19/38	49.4	162	0.046 - 0.050	1.17 - 1.27	14.2	6.44	2.60	3.87
M22759/21-24*	24	19/36	30.1	98.8	0.051 - 0.055	1.30 - 1.40	22.4	10.2	3.38	5.03
M22759/21-22*	22	19/34	18.6	61.0	0.058 - 0.062	1.47 - 1.57	35.8	16.2	4.61	6.86
M22759/21-20*	20	19/32	11.4	37.4	0.066 - 0.070	1.68 - 1.78	58.1	26.4	6.43	9.57

* The asterisks in the part number columns are to be replaced by numeric color code designations in accordance with MIL-STD-681D as shown in Color Code Chart No. 6 on page 33.

California

1959 East Cashdan Street, Rancho Dominguez, CA 90220
 (310) 609-1811 • (800) 326-0006 • FAX: (310) 609-1862
 E-Mail: salesrd@std-wire.com

Arizona

3120 West Thomas Road, Bldg. #801, Phoenix, AZ 85017
 (602) 269-2501 • (800) 325-6478 • FAX: (602) 278-7134
 E-Mail: salesphx@std-wire.com



Standard Wire & Cable Co.

MIL-W-22759/22



CONDUCTOR: Stranded silver-plated alloy. TEMPERATURE: -55° C to 200° C.
 VOLTAGE: 600 V INSULATION: PTFE.
 USES: Wire where resistance to high temperatures, high breaking strength, high reliability, and flexibility are required. For use where smoke emission, overload stability, and/or flammability may be a problem.

Military Part No.	AWG Size	Stranding	Max. Resistance @ 20° C (@ 68° F)		Diameter (minimum - maximum)		Minimum Breaking Strength		Weight Maximum	
			(ohms / 1000 ft)	(ohms / km)	(in)	(mm)	(lbs)	(kg)	(lbs / 1000 ft)	(kgs / km)
M22759/22-28-*	28	7/36	74.4	244	0.031 - 0.035	0.787 - 0.889	8.16	3.70	1.32	1.96
M22759/22-26-*	26	19/38	44.8	147	0.036 - 0.040	0.914 - 1.02	14.2	6.44	1.91	2.84
M22759/22-24-*	24	19/36	28.4	93.2	0.041 - 0.045	1.04 - 1.14	22.4	10.2	2.61	3.88
M22759/22-22-*	22	19/34	17.5	57.4	0.047 - 0.051	1.19 - 1.30	35.8	16.2	3.68	5.48
M22759/22-20-*	20	19/32	10.7	35.1	0.056 - 0.060	1.42 - 1.52	58.1	26.4	5.38	8.01

MIL-W-22759/23



CONDUCTOR: Stranded nickel-plated alloy. TEMPERATURE: -55° C to 260° C.
 VOLTAGE: 600 V INSULATION: PTFE.
 USES: Wire where resistance to high temperatures, high breaking strength, high reliability, and flexibility are required. For use where smoke emission, overload stability, and/or flammability may be a problem.

Military Part No.	AWG Size	Stranding	Max. Resistance @ 20° C (@ 68° F)		Diameter (minimum - maximum)		Minimum Breaking Strength		Weight Maximum	
			(ohms / 1000 ft)	(ohms / km)	(in)	(mm)	(lbs)	(kg)	(lbs / 1000 ft)	(kgs / km)
M22759/23-28-*	28	7/36	79.0	259	0.031 - 0.035	0.787 - 0.889	8.16	3.70	1.34	1.99
M22759/23-26-*	26	19/38	49.4	162	0.036 - 0.040	0.914 - 1.02	14.2	6.44	1.92	2.86
M22759/23-24-*	24	19/36	30.1	98.8	0.041 - 0.045	1.04 - 1.14	22.4	10.2	2.63	3.91
M22759/23-22-*	22	19/34	18.6	61.0	0.047 - 0.051	1.19 - 1.30	35.8	16.2	3.73	5.55
M22759/23-20-*	20	19/32	11.4	37.4	0.056 - 0.060	1.42 - 1.52	58.1	26.4	5.44	8.09

* The asterisks in the part number columns are to be replaced by numeric color code designations in accordance with MIL-STD-681D as shown in Color Code Chart No. 6 on page 33.

California

1959 East Cashdan Street, Rancho Dominguez, CA 90220
 (310) 609-1811 • (800) 326-0006 • FAX: (310) 609-1862
 E-Mail: salesrd@std-wire.com

Arizona

3120 West Thomas Road, Bldg. #801, Phoenix, AZ 85017
 (602) 269-2501 • (800) 325-6478 • FAX: (602) 278-7134
 E-Mail: salesphx@std-wire.com



Standard Wire & Cable Co.

MIL-W-22759/32



CONDUCTOR: Stranded tinned copper.
 INSULATION: 150° C, fluoropolymer, cross-linked modified ETFE single insulation, lightweight.
 VOLTAGE: 600 V

Military Part No.	AWG Size	Stranding	Max. Resistance @ 20° C (@ 68° F)		Diameter (minimum - maximum)		Weight Maximum	
			(ohms / 1000 ft)	(ohms / km)	(in)	(mm)	(lbs / 1000 ft)	(kgs / km)
M22759/32-30-*	30	7/38	108.4	355.6	0.022 - 0.026	0.559 - 0.660	0.66	0.98
M22759/32-28-*	28	7/36	68.6	225	0.025 - 0.029	0.635 - 0.737	0.91	1.4
M22759/32-26-*	26	19/38	41.3	135	0.030 - 0.034	0.762 - 0.864	1.4	2.1
M22759/32-24-*	24	19/36	26.2	86.0	0.035 - 0.039	0.889 - 0.991	2.0	3.0
M22759/32-22-*	22	19/34	16.2	53.1	0.041 - 0.045	1.04 - 1.14	2.8	4.2
M22759/32-20-*	20	19/32	9.88	32.4	0.048 - 0.052	1.22 - 1.32	4.3	6.4
M22759/32-18-*	18	19/30	6.23	20.4	0.058 - 0.062	1.47 - 1.57	6.5	9.7
M22759/32-16-*	16	19/29	4.81	15.8	0.066 - 0.070	1.68 - 1.78	8.3	12
M22759/32-14-*	14	19/27	3.06	10.0	0.082 - 0.088	2.08 - 2.24	13.0	19.3
M22759/32-12-*	12	37/28	2.02	6.63	0.100 - 0.106	2.54 - 2.69	19.7	29.3

MIL-W-22759/33



CONDUCTOR: Stranded silver-coated high strength copper alloy.
 INSULATION: 200° C, fluoropolymer, cross-linked modified ETFE single insulation, lightweight.
 VOLTAGE: 600 V

Military Part No.	AWG Size	Stranding	Max. Resistance @ 20° C (@ 68° F)		Diameter (minimum - maximum)		Weight Maximum	
			(ohms / 1000 ft)	(ohms / km)	(in)	(mm)	(lbs / 1000 ft)	(kgs / km)
M22759/33-30-*	30	7/38	117.4	385.2	0.022 - 0.026	0.559 - 0.660	0.66	0.98
M22759/33-28-*	28	7/36	74.4	244	0.025 - 0.029	0.635 - 0.737	0.91	1.4
M22759/33-26-*	26	19/38	44.8	147	0.030 - 0.034	0.762 - 0.864	1.4	2.1
M22759/33-24-*	24	19/36	28.4	93.2	0.037 - 0.039	0.940 - 0.991	2.0	3.0
M22759/33-22-*	22	19/34	17.5	57.4	0.041 - 0.045	1.04 - 1.14	2.9	4.3
M22759/33-20-*	20	19/32	10.7	35.1	0.048 - 0.052	1.22 - 1.32	4.4	6.5

* The asterisks in the part number columns are to be replaced by numeric color code designations in accordance with MIL-STD-681D as shown in Color Code Chart No. 6 on page 33.

California

1959 East Cashdan Street, Rancho Dominguez, CA 90220
 (310) 609-1811 • (800) 326-0006 • FAX: (310) 609-1862
 E-Mail: salesrd@std-wire.com

Arizona

3120 West Thomas Road, Bldg. #801, Phoenix, AZ 85017
 (602) 269-2501 • (800) 325-6478 • FAX: (602) 278-7134
 E-Mail: salesphx@std-wire.com



Standard Wire & Cable Co.

MIL-W-22759/34



CONDUCTOR: Stranded tinned copper.
 INSULATION: 150° C, fluoropolymer, cross-linked modified ETFE dual insulation, normal weight.
 2 AWG and larger, aromatic polyamide braid treated to prevent fraying.
 VOLTAGE: 600 V

Military Part No.	AWG Size	Stranding	Max. Resistance @ 20° C (@ 68° F)		Diameter (minimum - maximum)		Weight Maximum	
			(ohms / 1000 ft)	(ohms / km)	(in)	(mm)	(lbs / 1000 ft)	(kgs / km)
M22759/34-24-*	24	19/36	26.2	86.0	0.043 - 0.047	1.09 - 1.19	2.3	3.4
M22759/34-22-*	22	19/34	16.2	53.1	0.048 - 0.052	1.22 - 1.32	3.2	4.8
M22759/34-20-*	20	19/32	9.88	32.4	0.056 - 0.060	1.42 - 1.52	4.7	7.0
M22759/34-18-*	18	19/30	6.23	20.4	0.067 - 0.073	1.70 - 1.85	7.2	10.7
M22759/34-16-*	16	19/29	4.81	15.8	0.074 - 0.080	1.88 - 2.03	9.0	13.4
M22759/34-14-*	14	19/27	3.06	10.0	0.091 - 0.097	2.31 - 2.46	13.8	20.5
M22759/34-12-*	12	37/28	2.02	6.63	0.108 - 0.114	2.74 - 2.90	20.5	30.5
M22759/34-10-*	10	37/26	1.26	4.13	0.130 - 0.138	3.30 - 3.51	32.4	48.2
M22759/34-8-*	8	133/29	0.701	2.30	0.187 - 0.203	4.75 - 5.16	60.3	89.7
M22759/34-6-*	6	133/27	0.445	1.46	0.231 - 0.251	5.87 - 6.38	94.5	141
M22759/34-4-*	4	133/25	0.280	0.919	0.300 - 0.320	7.62 - 8.13	150	223
M22759/34-2-*	2	665/30	0.183	0.600	0.389 - 0.421	9.88 - 10.7	239	356
M22759/34-1-*	1	817/30	0.149	0.489	0.429 - 0.461	10.9 - 11.7	290	432
M22759/34-01-*	1/0	1,045/30	0.116	0.381	0.469 - 0.501	11.9 - 12.7	377	561
M22759/34-02-*	2/0	1,330/30	0.091	0.299	0.529 - 0.561	13.4 - 14.2	487	725

MIL-W-22759/35



CONDUCTOR: Stranded silver-coated high strength copper alloy.
 INSULATION: 200° C, fluoropolymer, cross-linked modified ETFE dual insulation, normal weight.
 VOLTAGE: 600 V

Military Part No.	AWG Size	Stranding	Max. Resistance @ 20° C (@ 68° F)		Diameter (minimum - maximum)		Weight Maximum	
			(ohms / 1000 ft)	(ohms / km)	(in)	(mm)	(lbs / 1000 ft)	(kgs / km)
M22759/35-26-*	26	19/38	44.8	147	0.038 - 0.042	0.97 - 1.07	1.7	2.5
M22759/35-24-*	24	19/36	28.4	93.2	0.043 - 0.047	1.09 - 1.19	2.3	3.4
M22759/35-22-*	22	19/34	17.5	57.4	0.048 - 0.052	1.22 - 1.32	3.3	4.9
M22759/35-20-*	20	19/32	10.7	35.1	0.056 - 0.060	1.42 - 1.52	4.8	7.1

* The asterisks in the part number columns are to be replaced by numeric color code designations in accordance with MIL-STD-681D as shown in Color Code Chart No. 6 on page 33.

California

1959 East Cashdan Street, Rancho Dominguez, CA 90220
 (310) 609-1811 • (800) 326-0006 • FAX: (310) 609-1862
 E-Mail: salesrd@std-wire.com

Arizona

3120 West Thomas Road, Bldg. #801, Phoenix, AZ 85017
 (602) 269-2501 • (800) 325-6478 • FAX: (602) 278-7134
 E-Mail: salesphx@std-wire.com



Standard Wire & Cable Co.

MIL-W-22759/41



CONDUCTOR: Stranded nickel-coated copper.
 INSULATION: 200° C, fluoropolymer, cross-linked modified ETFE dual insulation, normal weight.
 2 AWG and larger, aromatic polyamide braid treated to prevent fraying.
 VOLTAGE: 600 V

Military Part No.	AWG Size	Stranding	Max. Resistance @ 20° C (@ 68° F)		Diameter (minimum - maximum)		Weight Maximum	
			(ohms / 1000 ft)	(ohms / km)	(in)	(mm)	(lbs / 1000 ft)	(kgs / km)
M22759/41-26-*	26	19/38	42.2	138	0.038 - 0.042	0.965 - 1.07	1.7	2.5
M22759/41-24-*	24	19/36	25.9	85.0	0.043 - 0.047	1.09 - 1.19	2.3	3.4
M22759/41-22-*	22	19/34	16.0	52.5	0.048 - 0.052	1.22 - 1.32	3.2	4.8
M22759/41-20-*	20	19/32	9.77	32.1	0.056 - 0.060	1.42 - 1.52	4.7	7.0
M22759/41-18-*	18	19/30	6.10	20.0	0.067 - 0.073	1.70 - 1.85	7.2	11
M22759/41-16-*	16	19/29	4.76	15.6	0.074 - 0.080	1.88 - 2.03	9.0	13
M22759/41-14-*	14	19/27	3.00	9.84	0.091 - 0.097	2.31 - 2.46	13.8	20.5
M22759/41-12-*	12	37/28	1.98	6.50	0.108 - 0.114	2.74 - 2.90	20.5	30.5
M22759/41-10-*	10	37/26	1.24	4.07	0.130 - 0.138	3.30 - 3.51	32.4	48.2
M22759/41-8-*	8	133/29	0.694	2.28	0.187 - 0.203	4.75 - 5.16	64.2	95.5
M22759/41-6-*	6	133/27	0.436	1.43	0.231 - 0.251	5.87 - 6.38	96.8	144
M22759/41-4-*	4	133/25	0.275	0.902	0.300 - 0.320	7.62 - 8.13	163	243
M22759/41-2-*	2	665/30	0.177	0.581	0.389 - 0.421	9.88 - 10.7	246	366
M22759/41-1-*	1	817/30	0.144	0.472	0.429 - 0.461	10.9 - 11.7	314	467
M22759/41-01-*	1/0	1,045/30	0.113	0.371	0.469 - 0.501	11.9 - 12.7	421	626
M22759/41-02-*	2/0	1,330/30	0.089	0.292	0.529 - 0.561	13.4 - 14.2	518	771

MIL-W-22759/42



CONDUCTOR: Stranded nickel-coated high strength copper alloy.
 INSULATION: 200° C, fluoropolymer, cross-linked modified ETFE dual insulation, normal weight.
 VOLTAGE: 600 V

Military Part No.	AWG Size	Stranding	Max. Resistance @ 20° C (@ 68° F)		Diameter (minimum - maximum)		Weight Maximum	
			(ohms / 1000 ft)	(ohms / km)	(in)	(mm)	(lbs / 1000 ft)	(kgs / km)
M22759/42-26-*	26	19/38	49.4	162	0.038 - 0.042	0.965 - 1.07	1.7	2.5
M22759/42-24-*	24	19/36	30.1	98.8	0.043 - 0.047	1.09 - 1.19	2.3	3.4
M22759/42-22-*	22	19/34	18.6	61.0	0.048 - 0.052	1.22 - 1.32	3.3	4.9
M22759/42-20-*	20	19/32	11.4	37.4	0.056 - 0.060	1.42 - 1.52	4.8	7.1

* The asterisks in the part number columns are to be replaced by numeric color code designations in accordance with MIL-STD-681D as shown in Color Code Chart No. 6 on page 33.

California

1959 East Cashdan Street, Rancho Dominguez, CA 90220
 (310) 609-1811 • (800) 326-0006 • FAX: (310) 609-1862
 E-Mail: salesrd@std-wire.com

Arizona

3120 West Thomas Road, Bldg. #801, Phoenix, AZ 85017
 (602) 269-2501 • (800) 325-6478 • FAX: (602) 278-7134
 E-Mail: salesphx@std-wire.com



Standard Wire & Cable Co.

MIL-W-22759/43



CONDUCTOR: Stranded silver-coated copper.
 INSULATION: 200° C, fluoropolymer, cross-linked modified ETFE dual insulation, normal weight.
 2 AWG and larger, aromatic polyamide braid treated to prevent fraying.
 VOLTAGE: 600 V

Military Part No.	AWG Size	Stranding	Max. Resistance @ 20° C (@ 68° F)		Diameter (minimum - maximum)		Weight Maximum	
			(ohms / 1000 ft)	(ohms / km)	(in)	(mm)	(lbs / 1000 ft)	(kgs / km)
M22759/43-26-*	26	19/38	38.4	126	0.038 - 0.042	0.965 - 1.07	1.7	2.5
M22759/43-24-*	24	19/36	24.3	79.7	0.043 - 0.047	1.09 - 1.19	2.3	3.4
M22759/43-22-*	22	19/34	15.1	49.5	0.048 - 0.052	1.22 - 1.32	3.2	4.8
M22759/43-20-*	20	19/32	9.19	30.2	0.056 - 0.060	1.42 - 1.52	4.7	7.0
M22759/43-18-*	18	19/30	5.79	19.0	0.067 - 0.073	1.70 - 1.85	7.2	11
M22759/43-16-*	16	19/29	4.52	14.8	0.074 - 0.080	1.88 - 2.03	9.0	13
M22759/43-14-*	14	19/27	2.88	9.45	0.091 - 0.097	2.31 - 2.46	13.8	20.5
M22759/43-12-*	12	37/28	1.90	6.23	0.108 - 0.114	2.74 - 2.90	20.5	30.5
M22759/43-10-*	10	37/26	1.19	3.90	0.130 - 0.138	3.30 - 3.51	32.4	48.2
M22759/43-8-*	8	133/29	0.658	2.16	0.187 - 0.203	4.75 - 5.16	61.9	92.1
M22759/43-6-*	6	133/27	0.418	1.37	0.231 - 0.251	5.87 - 6.38	94.5	141
M22759/43-4-*	4	133/25	0.264	0.866	0.300 - 0.320	7.62 - 8.13	158	235
M22759/43-2-*	2	665/30	0.170	0.558	0.389 - 0.421	9.88 - 10.7	239	356
M22759/43-1-*	1	817/30	0.139	0.456	0.429 - 0.461	10.9 - 11.7	305	454
M22759/43-01-*	1/0	1,045/30	0.108	0.354	0.469 - 0.501	11.9 - 12.7	385	573
M22759/43-02-*	2/0	1,330/30	0.085	0.279	0.529 - 0.561	13.4 - 14.2	487	725

MIL-W-22759/44



CONDUCTOR: Stranded silver-coated copper.
 INSULATION: 200° C, fluoropolymer, cross-linked modified ETFE single insulation, lightweight.
 VOLTAGE: 600 V

Military Part No.	AWG Size	Stranding	Max. Resistance @ 20° C (@ 68° F)		Diameter (minimum - maximum)		Weight Maximum	
			(ohms / 1000 ft)	(ohms / km)	(in)	(mm)	(lbs / 1000 ft)	(kgs / km)
M22759/44-28-*	28	7/36	63.8	209	0.025 - 0.029	0.635 - 0.737	0.91	1.4
M22759/44-26-*	26	19/38	38.4	126	0.030 - 0.034	0.762 - 0.864	1.4	2.1
M22759/44-24-*	24	19/36	24.3	79.7	0.035 - 0.039	0.889 - 0.991	2.0	3.0
M22759/44-22-*	22	19/34	15.1	49.5	0.041 - 0.045	1.04 - 1.14	2.8	4.2
M22759/44-20-*	20	19/32	9.19	30.2	0.048 - 0.052	1.22 - 1.32	4.3	6.4
M22759/44-18-*	18	19/30	5.79	19.0	0.058 - 0.062	1.47 - 1.57	6.5	9.7
M22759/44-16-*	16	19/29	4.52	14.8	0.066 - 0.070	1.68 - 1.78	8.3	12
M22759/44-14-*	14	19/27	2.88	9.45	0.082 - 0.088	2.08 - 2.24	13.0	19.3
M22759/44-12-*	12	37/28	1.90	6.23	0.100 - 0.106	2.54 - 2.69	19.7	29.3

*The asterisks in the part number columns are to be replaced by numeric color code designations in accordance with MIL-STD-681D as shown in Color Code Chart No. 6 on page 33.

California

1959 East Cashdan Street, Rancho Dominguez, CA 90220
 (310) 609-1811 • (800) 326-0006 • FAX: (310) 609-1862
 E-Mail: salesrd@std-wire.com

Arizona

3120 West Thomas Road, Bldg. #801, Phoenix, AZ 85017
 (602) 269-2501 • (800) 325-6478 • FAX: (602) 278-7134
 E-Mail: salesphx@std-wire.com



Standard Wire & Cable Co.

MIL-W-22759/45



CONDUCTOR: Stranded nickel-coated copper.
 INSULATION: 200° C, fluoropolymer, cross-linked modified ETFE single insulation, lightweight.
 VOLTAGE: 600 V

Military Part No.	AWG Size	Stranding	Max. Resistance @ 20° C (@ 68° F)		Diameter (minimum - maximum)		Weight Maximum	
			(ohms / 1000 ft)	(ohms / km)	(in)	(mm)	(lbs / 1000 ft)	(kgs / km)
M22759/45-28-*	28	7/36	67.9	223	0.025 - 0.029	0.635 - 0.737	0.91	1.4
M22759/45-26-*	26	19/38	42.2	138	0.030 - 0.034	0.762 - 0.864	1.4	2.1
M22759/45-24-*	24	19/36	25.9	85.0	0.035 - 0.039	0.889 - 0.991	2.0	3.0
M22759/45-22-*	22	19/34	16.0	52.5	0.041 - 0.045	1.04 - 1.14	2.8	4.2
M22759/45-20-*	20	19/32	9.77	32.1	0.048 - 0.052	1.22 - 1.32	4.3	6.4
M22759/45-18-*	18	19/30	6.10	20.0	0.058 - 0.062	1.47 - 1.57	6.5	9.7
M22759/45-16-*	16	19/29	4.76	15.6	0.066 - 0.070	1.68 - 1.78	8.3	12
M22759/45-14-*	14	19/27	3.00	9.84	0.082 - 0.088	2.08 - 2.24	13.0	19.3
M22759/45-12-*	12	37/28	1.98	6.50	0.100 - 0.106	2.54 - 2.69	19.7	29.3

MIL-W-22759/46



CONDUCTOR: Stranded nickel-coated high strength copper alloy.
 INSULATION: 200° C, fluoropolymer, cross-linked modified ETFE single insulation, lightweight.
 VOLTAGE: 600 V

Military Part No.	AWG Size	Stranding	Max. Resistance @ 20° C (@ 68° F)		Diameter (minimum - maximum)		Weight Maximum	
			(ohms / 1000 ft)	(ohms / km)	(in)	(mm)	(lbs / 1000 ft)	(kgs / km)
M22759/46-28-*	28	7/36	79.0	259	0.025 - 0.029	0.635 - 0.737	0.91	1.4
M22759/46-26-*	26	19/38	49.4	162	0.030 - 0.034	0.762 - 0.864	1.4	2.1
M22759/46-24-*	24	19/36	30.1	98.8	0.035 - 0.039	0.889 - 0.991	2.0	3.0
M22759/46-22-*	22	19/34	18.6	61.0	0.041 - 0.045	1.04 - 1.14	2.9	4.3
M22759/46-20-*	20	19/32	11.4	37.4	0.048 - 0.052	1.22 - 1.32	4.4	6.5

* The asterisks in the part number columns are to be replaced by numeric color code designations in accordance with MIL-STD-681D as shown in Color Code Chart No. 6 on page 33.

California

1959 East Cashdan Street, Rancho Dominguez, CA 90220
 (310) 609-1811 • (800) 326-0006 • FAX: (310) 609-1862
 E-Mail: salesrd@std-wire.com

Arizona

3120 West Thomas Road, Bldg. #801, Phoenix, AZ 85017
 (602) 269-2501 • (800) 325-6478 • FAX: (602) 278-7134
 E-Mail: salesphx@std-wire.com



Standard Wire & Cable Co.

MIL-W-22759/80A



CONDUCTOR: Stranded tin-coated copper.
 INSULATION: 150° C, composite tape (FP/polyimide/FP tape) and FP tape, lightweight.
 VOLTAGE: 600 V

Military Part No.	AWG Size	Stranding	Max. Resistance @ 20° C (@ 68° F)		Diameter (minimum - maximum)		Weight Maximum	
			(ohms / 1000 ft)	(ohms / km)	(in)	(mm)	(lbs / 1000 ft)	(kgs / km)
M22759/80-26-*	26	19/38	41.3	135	0.030 - 0.034	0.762 - 0.864	1.43	2.13
M22759/80-24-*	24	19/36	26.2	86.0	0.034 - 0.038	0.864 - 0.965	1.93	2.87
M22759/80-22-*	22	19/34	16.2	53.1	0.040 - 0.043	1.02 - 1.09	2.85	4.24
M22759/80-20-*	20	19/32	9.88	32.4	0.048 - 0.051	1.22 - 1.30	4.38	6.52
M22759/80-18-*	18	19/30	6.23	20.4	0.056 - 0.060	1.42 - 1.52	6.60	9.82
M22759/80-16-*	16	19/29	4.81	15.8	0.063 - 0.067	1.60 - 1.70	8.30	12.4
M22759/80-14-*	14	19/27	3.06	10.0	0.076 - 0.080	1.93 - 2.03	12.6	18.7
M22759/80-12-*	12	37/28	2.02	6.63	0.096 - 0.100	2.44 - 2.54	19.6	29.2
M22759/80-10-*	10	37/26	1.26	4.13	0.119 - 0.123	3.02 - 3.12	30.6	45.5

MIL-W-22759/81A



CONDUCTOR: Stranded silver-coated high strength copper alloy (26 AWG is ultrahigh strength copper alloy).
 INSULATION: 200° C, composite tape (FP/polyimide/FP tape) and FP tape, lightweight.
 VOLTAGE: 600 V

Military Part No.	AWG Size	Stranding	Max. Resistance @ 20° C (@ 68° F)		Diameter (minimum - maximum)		Weight Maximum	
			(ohms / 1000 ft)	(ohms / km)	(in)	(mm)	(lbs / 1000 ft)	(kgs / km)
M22759/81-26-*	26	19/38	56.4	185	0.030 - 0.034	0.762 - 0.864	1.43	2.13
M22759/81-24-*	24	19/36	28.4	93.2	0.034 - 0.038	0.864 - 0.965	1.93	2.87
M22759/81-22-*	22	19/34	17.5	57.4	0.040 - 0.043	1.02 - 1.09	2.85	4.24
M22759/81-20-*	20	19/32	10.7	35.1	0.048 - 0.051	1.22 - 1.30	4.38	6.52

* The asterisks in the part number columns are to be replaced by numeric color code designations in accordance with MIL-STD-681D as shown in Color Code Chart No. 6 on page 33.

California

1959 East Cashdan Street, Rancho Dominguez, CA 90220
 (310) 609-1811 • (800) 326-0006 • FAX: (310) 609-1862
 E-Mail: salesrd@std-wire.com

Arizona

3120 West Thomas Road, Bldg. #801, Phoenix, AZ 85017
 (602) 269-2501 • (800) 325-6478 • FAX: (602) 278-7134
 E-Mail: salesphx@std-wire.com



Standard Wire & Cable Co.

MIL-W-22759/82A



CONDUCTOR: Stranded nickel-coated high strength copper alloy (26 AWG is ultrahigh strength copper alloy).
 INSULATION: 260° C, composite tape (FP/polyimide/FP tape) and FP tape, lightweight.
 VOLTAGE: 600 V

Military Part No.	AWG Size	Stranding	Max. Resistance @ 20° C (@ 68° F)		Diameter (minimum - maximum)		Weight Maximum	
			(ohms / 1000 ft)	(ohms / km)	(in)	(mm)	(lbs / 1000 ft)	(kgs / km)
M22759/82-26-*	26	19/38	58.4	192	0.030 - 0.034	0.762 - 0.864	1.43	2.13
M22759/82-24-*	24	19/36	30.1	98.8	0.034 - 0.038	0.864 - 0.965	1.93	2.87
M22759/82-22-*	22	19/34	18.6	61.0	0.040 - 0.043	1.02 - 1.09	2.85	4.24
M22759/82-20-*	20	19/32	11.4	37.4	0.048 - 0.051	1.22 - 1.30	4.38	6.52

* The asterisks in the part number columns are to be replaced by numeric color code designations in accordance with MIL-STD-681D as shown in Color Code Chart No. 6 on page 33.

MIL-W-22759/83A



CONDUCTOR: Stranded silver-coated copper.
 INSULATION: 200° C, FP tape, composite tape (FP/polyimide/FP tape), FP tape, FP tape, and aromatic polyamide braid treated to prevent fraying, normal weight.
 VOLTAGE: 600 V
 COLOR: Preferred color is dark green with the color designator 5D. White is an acceptable alternative with a color designator of 9.

Military Part No.	AWG Size	Stranding	Max. Resistance @ 20° C (@ 68° F)		Diameter (minimum - maximum)		Weight Maximum	
			(ohms / 1000 ft)	(ohms / km)	(in)	(mm)	(lbs / 1000 ft)	(kgs / km)
M22759/83-2-**	2	665/30	0.170	0.558	0.360 - 0.380	9.14 - 9.65	227.0	337.8
M22759/83-1-**	1	817/30	0.139	0.456	0.400 - 0.420	10.2 - 10.7	295.0	439.0
M22759/83-01-**	1/0	1,045/30	0.108	0.354	0.442 - 0.462	11.2 - 11.7	351.0	522.3
M22759/83-02-**	2/0	1,330/30	0.085	0.279	0.498 - 0.528	12.6 - 13.4	432.0	642.8
M22759/83-03-**	3/0	1,665/30	0.068	0.223	0.554 - 0.584	14.1 - 14.8	542.0	806.5
M22759/83-04-**	4/0	2,109/30	0.054	0.177	0.615 - 0.655	15.6 - 16.6	689.0	1,025.

** The asterisks in the part number columns are to be replaced by numeric color code designations of either 5D (green) or 9 (white).

California

1959 East Cashdan Street, Rancho Dominguez, CA 90220
 (310) 609-1811 • (800) 326-0006 • FAX: (310) 609-1862
 E-Mail: salesrd@std-wire.com

Arizona

3120 West Thomas Road, Bldg. #801, Phoenix, AZ 85017
 (602) 269-2501 • (800) 325-6478 • FAX: (602) 278-7134
 E-Mail: salesphx@std-wire.com



Standard Wire & Cable Co.

MIL-W-22759/84A



CONDUCTOR: Stranded nickel-coated copper.
 INSULATION: 260° C, FP tape, composite tape (FP/polyimide/FP tape), FP tape, FP tape, and aromatic polyamide braid treated to prevent fraying, normal weight.
 VOLTAGE: 600 V
 COLOR: Preferred color is dark green with the color designator 5D. White is an acceptable alternative with a color designator of 9.

Military Part No.	AWG Size	Stranding	Max. Resistance @ 20° C (@ 68° F)		Diameter (minimum - maximum)		Weight Maximum	
			(ohms / 1000 ft)	(ohms / km)	(in)	(mm)	(lbs / 1000 ft)	(kgs / km)
M22759/84-2-*	2	665/30	0.177	0.581	0.360 - 0.380	9.14 - 9.65	227.0	337.8
M22759/84-1-*	1	817/30	0.144	0.472	0.400 - 0.420	10.2 - 10.7	295.0	439.0
M22759/84-01-*	1/0	1,045/30	0.113	0.371	0.442 - 0.462	11.2 - 11.7	351.0	522.3
M22759/84-02-*	2/0	1,330/30	0.089	0.292	0.498 - 0.528	12.6 - 13.4	432.0	642.8
M22759/84-03-*	3/0	1,665/30	0.071	0.233	0.554 - 0.584	14.1 - 14.8	542.0	806.5
M22759/84-04-*	4/0	2,109/30	0.056	0.184	0.615 - 0.655	15.6 - 16.6	689.0	1,025

* The asterisks in the part number columns are to be replaced by numeric color code designations of either 5D (green) or 9 (white).

MIL-W-22759/85A



CONDUCTOR: Stranded tin-coated copper.
 INSULATION: 150° C, FP tape, composite tape (FP/polyimide/FP tape), FP tape, FP tape, and aromatic polyamide braid treated to prevent fraying, normal weight.
 VOLTAGE: 600 V
 COLOR: Preferred color is dark green with the color designator 5D. White is an acceptable alternative with a color designator of 9.

Military Part No.	AWG Size	Stranding	Max. Resistance @ 20° C (@ 68° F)		Diameter (minimum - maximum)		Weight Maximum	
			(ohms / 1000 ft)	(ohms / km)	(in)	(mm)	(lbs / 1000 ft)	(kgs / km)
M22759/85-2-*	2	665/30	0.183	0.600	0.360 - 0.380	9.14 - 9.65	227.0	337.8
M22759/85-1-*	1	817/30	0.149	0.489	0.400 - 0.420	10.2 - 10.7	295.0	439.0
M22759/85-01-*	1/0	1,045/30	0.116	0.381	0.442 - 0.462	11.2 - 11.7	351.0	522.3
M22759/85-02-*	2/0	1,330/30	0.091	0.299	0.498 - 0.528	12.6 - 13.4	432.0	642.8
M22759/85-03-*	3/0	1,665/30	0.071	0.233	0.554 - 0.584	14.1 - 14.8	542.0	806.5
M22759/85-04-*	4/0	2,109/30	0.056	0.184	0.615 - 0.655	15.6 - 16.6	689.0	1,025

* The asterisks in the part number columns are to be replaced by numeric color code designations of either 5D (green) or 9 (white).

California

1959 East Cashdan Street, Rancho Dominguez, CA 90220
 (310) 609-1811 • (800) 326-0006 • FAX: (310) 609-1862
 E-Mail: salesrd@std-wire.com

Arizona

3120 West Thomas Road, Bldg. #801, Phoenix, AZ 85017
 (602) 269-2501 • (800) 325-6478 • FAX: (602) 278-7134
 E-Mail: salesphx@std-wire.com



Standard Wire & Cable Co.

MIL-W-22759/86A



CONDUCTOR: Stranded silver-coated copper.
 INSULATION: 200° C, for 26 AWG through 10 AWG, composite tape (FP/polyimide/FP tape) and FP tape; for 8 AWG through 6 AWG, FP tape, composite tape (FP/polyimide/FP tape), and FP tape; for 4 AWG through 4/0 AWG, FP tape, composite tape (FP/polyimide/FP tape), FP tape, and FP tape, normal weight.
 VOLTAGE: 600 V

Military Part No.	AWG Size	Stranding	Max. Resistance @ 20° C (@ 68° F)		Diameter (minimum - maximum)		Weight Maximum	
			(ohms / 1000 ft)	(ohms / km)	(in)	(mm)	(lbs / 1000 ft)	(kgs / km)
M22759/86-26-*	26	19/38	38.4	126	0.033 - 0.037	0.838 - 0.940	1.55	2.31
M22759/86-24-*	24	19/36	24.3	79.7	0.038 - 0.042	0.965 - 1.067	2.20	3.27
M22759/86-22-*	22	19/34	15.1	49.5	0.043 - 0.047	1.09 - 1.19	3.00	4.46
M22759/86-20-*	20	19/32	9.19	30.2	0.051 - 0.055	1.30 - 1.40	4.55	6.77
M22759/86-18-*	18	19/30	5.79	19.0	0.061 - 0.065	1.55 - 1.65	6.70	9.97
M22759/86-16-*	16	19/29	4.52	14.8	0.068 - 0.073	1.73 - 1.85	8.60	12.8
M22759/86-14-*	14	19/27	2.88	9.45	0.081 - 0.086	2.06 - 2.18	12.95	19.27
M22759/86-12-*	12	37/28	1.90	6.23	0.100 - 0.105	2.54 - 2.67	20.1	29.9
M22759/86-10-*	10	37/26	1.19	3.90	0.122 - 0.127	2.54 - 3.23	31.4	46.7
M22759/86-8-*	8	133/29	0.658	2.16	0.180 - 0.188	4.57 - 4.78	57.6	85.7
M22759/86-6-*	6	133/27	0.418	1.37	0.219 - 0.229	5.56 - 5.82	88.3	131
M22759/86-4-*	4	133/25	0.264	0.866	0.276 - 0.288	7.01 - 7.32	143.0	212.8
M22759/86-2-*	2	665/30	0.170	0.558	0.344 - 0.364	8.74 - 9.25	223.0	331.8
M22759/86-1-*	1	817/30	0.139	0.456	0.388 - 0.408	9.86 - 10.4	289.0	430.0
M22759/86-01-*	1/0	1,045/30	0.108	0.354	0.420 - 0.450	10.7 - 11.4	345.0	513.4
M22759/86-02-*	2/0	1,330/30	0.085	0.279	0.475 - 0.505	12.1 - 12.8	432.0	642.8
M22759/86-03-*	3/0	1,665/30	0.068	0.223	0.530 - 0.560	13.5 - 14.2	542.0	806.5
M22759/86-04-*	4/0	2,109/30	0.054	0.177	0.590 - 0.630	15.0 - 16.0	681.0	1,013

* The asterisks in the part number column are to be replaced by numeric color code designations in accordance with MIL-STD-681D as shown in Color Code Chart No. 6 on page 33.

California

1959 East Cashdan Street, Rancho Dominguez, CA 90220
 (310) 609-1811 • (800) 326-0006 • FAX: (310) 609-1862
 E-Mail: salesrd@std-wire.com

Arizona

3120 West Thomas Road, Bldg. #801, Phoenix, AZ 85017
 (602) 269-2501 • (800) 325-6478 • FAX: (602) 278-7134
 E-Mail: salesphx@std-wire.com



Standard Wire & Cable Co.

MIL-W-22759/87A



CONDUCTOR: Stranded nickel-coated copper.
 INSULATION: 260° C, for 26 AWG through 10 AWG, composite tape (FP/polyimide/FP tape) and FP tape; for 8 AWG through 6 AWG, FP tape, composite tape (FP/polyimide/FP tape), and FP tape; for 4 AWG through 4/0 AWG, FP tape, composite tape (FP/polyimide/FP tape), FP tape, and FP tape, normal weight.
 VOLTAGE: 600 V

Military Part No.	AWG Size	Stranding	Max. Resistance @ 20° C (@ 68° F)		Diameter (minimum - maximum)		Weight Maximum	
			(ohms / 1000 ft)	(ohms / km)	(in)	(mm)	(lbs / 1000 ft)	(kgs / km)
M22759/87-26-*	26	19/38	42.4	139	0.033 - 0.037	0.838 - 0.940	1.55	2.31
M22759/87-24-*	24	19/36	25.9	85.0	0.038 - 0.042	0.965 - 1.07	2.15	3.20
M22759/87-22-*	22	19/34	16.0	52.5	0.043 - 0.047	1.09 - 1.19	3.00	4.46
M22759/87-20-*	20	19/32	9.77	32.1	0.051 - 0.055	1.30 - 1.40	4.55	6.77
M22759/87-18-*	18	19/30	6.10	20.0	0.061 - 0.065	1.55 - 1.65	6.70	9.97
M22759/87-16-*	16	19/29	4.76	15.6	0.068 - 0.073	1.73 - 1.85	8.60	12.8
M22759/87-14-*	14	19/27	3.00	9.84	0.081 - 0.086	2.06 - 2.18	12.95	19.27
M22759/87-12-*	12	37/28	1.98	6.50	0.100 - 0.105	2.54 - 2.67	20.1	29.9
M22759/87-10-*	10	37/26	1.24	4.07	0.122 - 0.127	3.10 - 3.23	31.4	46.7
M22759/87-8-*	8	133/29	0.694	2.28	0.180 - 0.188	4.57 - 4.78	57.6	85.7
M22759/87-6-*	6	133/27	0.436	1.43	0.219 - 0.229	5.56 - 5.82	88.3	131
M22759/87-4-*	4	133/25	0.275	0.902	0.276 - 0.288	7.01 - 7.32	143.0	212.8
M22759/87-2-*	2	665/30	0.177	0.581	0.344 - 0.364	8.74 - 9.25	220.0	327.4
M22759/87-1-*	1	817/30	0.144	0.472	0.388 - 0.408	9.86 - 10.4	289.0	430.0
M22759/87-01-*	1/0	1,045/30	0.113	0.371	0.420 - 0.450	10.7 - 11.4	345.0	513.4
M22759/87-02-*	2/0	1,330/30	0.089	0.292	0.475 - 0.505	12.1 - 12.8	432.0	642.8
M22759/87-03-*	3/0	1,665/30	0.071	0.233	0.530 - 0.560	13.5 - 14.2	542.0	806.5
M22759/87-04-*	4/0	2,109/30	0.056	0.184	0.590 - 0.630	15.0 - 16.0	681.0	1,013

* The asterisks in the part number column are to be replaced by numeric color code designations in accordance with MIL-STD-681D as shown in Color Code Chart No. 6 on page 33.

California

1959 East Cashdan Street, Rancho Dominguez, CA 90220
 (310) 609-1811 • (800) 326-0006 • FAX: (310) 609-1862
 E-Mail: salesrd@std-wire.com

Arizona

3120 West Thomas Road, Bldg. #801, Phoenix, AZ 85017
 (602) 269-2501 • (800) 325-6478 • FAX: (602) 278-7134
 E-Mail: salesphx@std-wire.com



Standard Wire & Cable Co.

MIL-W-22759/88A



CONDUCTOR: Stranded tin-coated copper.
 INSULATION: 150° C, for 26 AWG through 10 AWG, composite tape (FP/polyimide/FP tape) and FP tape; for 8 AWG through 6 AWG, FP tape, composite tape (FP/polyimide/FP tape), and FP tape; for 4 AWG through 4/0 AWG, FP tape, composite tape (FP/polyimide/FP tape), FP tape, and FP tape, normal weight.
 VOLTAGE: 600 V

Military Part No.	AWG Size	Stranding	Max. Resistance @ 20° C (@ 68° F)		Diameter (minimum - maximum)		Weight Maximum	
			(ohms / 1000 ft)	(ohms / km)	(in)	(mm)	(lbs / 1000 ft)	(kgs / km)
M22759/88-26-*	26	19/38	41.3	135	0.033 - 0.037	0.838 - 0.940	1.55	2.31
M22759/88-24-*	24	19/36	26.2	86.0	0.038 - 0.042	0.965 - 1.07	2.15	3.20
M22759/88-22-*	22	19/34	16.2	53.1	0.043 - 0.047	1.09 - 1.19	3.00	4.46
M22759/88-20-*	20	19/32	9.88	32.4	0.051 - 0.055	1.30 - 1.40	4.55	6.77
M22759/88-18-*	18	19/30	6.23	20.4	0.061 - 0.065	1.55 - 1.65	6.70	9.97
M22759/88-16-*	16	19/29	4.81	15.8	0.068 - 0.073	1.73 - 1.85	8.60	12.8
M22759/88-14-*	14	19/27	3.06	10.0	0.081 - 0.086	2.06 - 2.18	12.95	19.27
M22759/88-12-*	12	37/28	2.02	6.63	0.100 - 0.105	2.54 - 2.67	20.1	29.9
M22759/88-10-*	10	37/26	1.26	4.13	0.122 - 0.127	3.10 - 3.23	31.4	46.7
M22759/88-8-*	8	133/29	0.701	2.30	0.180 - 0.188	4.57 - 4.78	57.6	85.7
M22759/88-6-*	6	133/27	0.445	1.46	0.219 - 0.229	5.56 - 5.82	88.3	131
M22759/88-4-*	4	133/25	0.280	0.919	0.276 - 0.288	7.01 - 7.32	143.0	212.8
M22759/88-2-*	2	665/30	0.183	0.600	0.344 - 0.364	8.74 - 9.25	220.0	327.4
M22759/88-1-*	1	817/30	0.149	0.489	0.388 - 0.408	9.86 - 10.4	289.0	430.0
M22759/88-01-*	1/0	1,045/30	0.116	0.381	0.420 - 0.450	10.7 - 11.4	345.0	513.4
M22759/88-02-*	2/0	1,330/30	0.091	0.299	0.475 - 0.505	12.1 - 12.8	432.0	642.8
M22759/88-03-*	3/0	1,665/30	0.071	0.233	0.530 - 0.560	13.5 - 14.2	542.0	806.5
M22759/88-04-*	4/0	2,109/30	0.056	0.184	0.590 - 0.630	15.0 - 16.0	681.0	1,013

* The asterisks in the part number columns are to be replaced by numeric color code designations in accordance with MIL-STD-681D as shown in Color Code Chart No. 6 on page 33.

California

1959 East Cashdan Street, Rancho Dominguez, CA 90220
 (310) 609-1811 • (800) 326-0006 • FAX: (310) 609-1862
 E-Mail: salesrd@std-wire.com

Arizona

3120 West Thomas Road, Bldg. #801, Phoenix, AZ 85017
 (602) 269-2501 • (800) 325-6478 • FAX: (602) 278-7134
 E-Mail: salesphx@std-wire.com



Standard Wire & Cable Co.

MIL-W-22759/89A



CONDUCTOR: Stranded silver-coated high strength copper alloy (26 AWG is ultrahigh strength copper alloy).
 INSULATION: 200° C, composite tape (FP/polyimide/FP tape) and FP tape, normal weight.
 VOLTAGE: 600 V

Military Part No.	AWG Size	Stranding	Max. Resistance @ 20° C (@ 68° F)		Diameter (minimum - maximum)		Weight Maximum	
			(ohms / 1000 ft)	(ohms / km)	(in)	(mm)	(lbs / 1000 ft)	(kgs / km)
M22759/89-26-*	26	19/38	56.4	185	0.033 - 0.037	0.838 - 0.940	1.55	2.31
M22759/89-24-*	24	19/36	28.4	93.2	0.038 - 0.042	0.965 - 1.07	2.15	3.20
M22759/89-22-*	22	19/34	17.5	57.4	0.043 - 0.047	1.09 - 1.19	3.00	4.46
M22759/89-20-*	20	19/32	10.7	35.1	0.051 - 0.055	1.30 - 1.40	4.55	6.77

MIL-W-22759/90A



CONDUCTOR: Stranded nickel-coated high strength copper alloy (26 AWG is ultrahigh strength copper alloy).
 INSULATION: 260° C, composite tape (FP/polyimide/FP tape) and FP tape, normal weight.
 VOLTAGE: 600 V

Military Part No.	AWG Size	Stranding	Max. Resistance @ 20° C (@ 68° F)		Diameter (minimum - maximum)		Weight Maximum	
			(ohms / 1000 ft)	(ohms / km)	(in)	(mm)	(lbs / 1000 ft)	(kgs / km)
M22759/90-26-*	26	19/38	58.4	192	0.033 - 0.037	0.838 - 0.940	1.55	2.31
M22759/90-24-*	24	19/36	30.1	98.8	0.038 - 0.042	0.965 - 1.07	2.15	3.20
M22759/90-22-*	22	19/34	18.6	61.0	0.043 - 0.047	1.09 - 1.19	3.00	4.46
M22759/90-20-*	20	19/32	11.4	37.4	0.051 - 0.055	1.30 - 1.40	4.55	6.77

* The asterisks in the part number columns are to be replaced by numeric color code designations in accordance with MIL-STD-681D as shown in Color Code Chart No. 6 on page 33.

California

1959 East Cashdan Street, Rancho Dominguez, CA 90220
 (310) 609-1811 • (800) 326-0006 • FAX: (310) 609-1862
 E-Mail: salesrd@std-wire.com

Arizona

3120 West Thomas Road, Bldg. #801, Phoenix, AZ 85017
 (602) 269-2501 • (800) 325-6478 • FAX: (602) 278-7134
 E-Mail: salesphx@std-wire.com



Standard Wire & Cable Co.

MIL-W-22759/91A



CONDUCTOR: Stranded silver-coated copper.
 INSULATION: 200° C, composite tape (FP/polyimide/FP tape) and FP tape, lightweight.
 VOLTAGE: 600 V

Military Part No.	AWG Size	Stranding	Max. Resistance @ 20° C (@ 68° F)		Diameter (minimum - maximum)		Weight Maximum	
			(ohms / 1000 ft)	(ohms / km)	(in)	(mm)	(lbs / 1000 ft)	(kgs / km)
M22759/91-26-*	26	19/38	38.4	126	0.030 - 0.034	0.762 - 0.864	1.43	2.13
M22759/91-24-*	24	19/36	24.3	79.7	0.034 - 0.038	0.864 - 0.965	1.93	2.87
M22759/91-22-*	22	19/34	15.1	49.5	0.040 - 0.043	1.02 - 1.09	2.85	4.24
M22759/91-20-*	20	19/32	9.19	30.2	0.048 - 0.051	1.22 - 1.30	4.38	6.52
M22759/91-18-*	18	19/30	5.79	19.0	0.056 - 0.060	1.42 - 1.52	6.60	9.82
M22759/91-16-*	16	19/29	4.52	14.8	0.063 - 0.067	1.60 - 1.70	8.30	12.4
M22759/91-14-*	14	19/27	2.88	9.45	0.076 - 0.080	1.93 - 2.03	12.6	18.7
M22759/91-12-*	12	37/28	1.90	6.23	0.096 - 0.100	2.44 - 2.54	19.6	29.2
M22759/91-10-*	10	37/26	1.19	3.90	0.119 - 0.123	3.02 - 3.12	30.6	45.5

MIL-W-22759/92A



CONDUCTOR: Stranded nickel-coated copper.
 INSULATION: 260° C, composite tape (FP/polyimide/FP tape) and FP tape, lightweight.
 VOLTAGE: 600 V

Military Part No.	AWG Size	Stranding	Max. Resistance @ 20° C (@ 68° F)		Diameter (minimum - maximum)		Weight Maximum	
			(ohms / 1000 ft)	(ohms / km)	(in)	(mm)	(lbs / 1000 ft)	(kgs / km)
M22759/92-26-*	26	19/38	42.2	138	0.030 - 0.034	0.762 - 0.864	1.43	2.13
M22759/92-24-*	24	19/36	25.9	85.0	0.034 - 0.038	0.864 - 0.965	1.93	2.87
M22759/92-22-*	22	19/34	16.0	52.5	0.040 - 0.043	1.02 - 1.09	2.85	4.24
M22759/92-20-*	20	19/32	9.77	32.1	0.048 - 0.051	1.22 - 1.30	4.38	6.52
M22759/92-18-*	18	19/30	6.10	20.0	0.056 - 0.060	1.42 - 1.52	6.60	9.82
M22759/92-16-*	16	19/29	4.76	15.6	0.063 - 0.067	1.60 - 1.70	8.30	12.4
M22759/92-14-*	14	19/27	3.00	9.84	0.076 - 0.080	1.93 - 2.03	12.6	18.7
M22759/92-12-*	12	37/28	1.98	6.50	0.096 - 0.100	2.44 - 2.54	19.6	29.2
M22759/92-10-*	10	37/26	1.24	4.07	0.119 - 0.123	3.02 - 3.12	30.6	45.5

* The asterisks in the part number column are to be replaced by numeric color code designations in accordance with MIL-STD-681D as shown in Color Code Chart No. 6 on page 33.

California

1959 East Cashdan Street, Rancho Dominguez, CA 90220
 (310) 609-1811 • (800) 326-0006 • FAX: (310) 609-1862
 E-Mail: salesrd@std-wire.com

Arizona

3120 West Thomas Road, Bldg. #801, Phoenix, AZ 85017
 (602) 269-2501 • (800) 325-6478 • FAX: (602) 278-7134
 E-Mail: salesphx@std-wire.com



Standard Wire & Cable Co.

MIL-W-81044/9 Medium Weight Wall



CONDUCTOR: Stranded tin-coated copper.
 INSULATION: 150° C, cross-linked extruded polyalkene.
 JACKET: Cross-linked extruded polyvinylidene fluoride.
 VOLTAGE: 600 V

Military Part No.	AWG Size	Stranding	Max. Resistance @ 20° C (@ 68° F)		Diameter (minimum - maximum)				Weight Maximum	
			(ohms / 1000 ft)	(ohms / km)	(in)		(mm)		(lbs / 1000 ft)	(kgs / km)
M81044/9-24-*	24	19/36	26.2	86.0	0.052	0.056	1.32	1.42	2.70	4.02
M81044/9-22-*	22	19/34	16.2	53.1	0.059	0.065	1.50	1.65	3.90	5.80
M81044/9-20-*	20	19/32	9.88	32.4	0.067	0.073	1.70	1.85	5.50	8.18
M81044/9-18-*	18	19/30	6.23	20.4	0.077	0.083	1.96	2.11	8.00	11.9
M81044/9-16-*	16	19/29	4.81	15.8	0.085	0.093	2.16	2.36	10.1	15.0
M81044/9-14-*	14	19/27	3.06	10.0	0.104	0.112	2.64	2.84	15.5	23.1
M81044/9-12-*	12	37/28	2.02	6.63	0.122	0.130	3.10	3.30	23.0	34.2
M81044/9-10-*	10	37/26	1.26	4.13	0.150	0.160	3.81	4.06	35.7	53.2
M81044/9-8-*	8	133/29	0.701	2.30	0.208	0.220	5.28	5.59	62.8	93.4
M81044/9-6-*	6	133/27	0.445	1.46	0.257	0.271	6.53	6.88	99.3	148
M81044/9-4-*	4	133/25	0.280	0.919	0.312	0.328	7.92	8.33	153	228
M81044/9-2-*	2	665/30	0.183	0.600	0.388	0.412	9.86	10.5	247	368
M81044/9-0-*	1/0	1,045/30	0.116	0.381	0.474	0.506	12.0	12.9	377	561

* The asterisks in the part number column are to be replaced by numeric color code designations in accordance with MIL-STD-681D as shown in Color Code Chart No. 6 on page 33.

California

1959 East Cashdan Street, Rancho Dominguez, CA 90220
 (310) 609-1811 • (800) 326-0006 • FAX: (310) 609-1862
 E-Mail: salesrd@std-wire.com

Arizona

3120 West Thomas Road, Bldg. #801, Phoenix, AZ 85017
 (602) 269-2501 • (800) 325-6478 • FAX: (602) 278-7134
 E-Mail: salesphx@std-wire.com



Standard Wire & Cable Co.

MIL-W-81044/12 Lightweight Wall



CONDUCTOR: Stranded tin-coated copper.
 INSULATION: 150° C, cross-linked extruded polyalkene.
 JACKET: Cross-linked extruded polyvinylidene fluoride.
 VOLTAGE: 600 V

Military Part No.	AWG Size	Stranding	Max. Resistance @ 20° C (@ 68° F)		Diameter (minimum - maximum)				Weight Maximum	
			(ohms / 1000 ft)	(ohms / km)	(in)	(mm)			(lbs / 1000 ft)	(kgs / km)
M81044/12-30-*	30	7/38	108.4	355.6	0.025	0.029	0.635	0.737	0.71	1.1
M81044/12-28-*	28	7/36	68.6	225	0.028	0.032	0.711	0.813	0.96	1.4
M81044/12-26-*	26	19/38	41.3	135	0.032	0.036	0.813	0.914	1.40	2.08
M81044/12-24-*	24	19/36	26.2	86.0	0.038	0.042	0.965	1.07	2.10	3.12
M81044/12-22-*	22	19/34	16.2	53.1	0.045	0.049	1.14	1.24	3.10	4.61
M81044/12-20-*	20	19/32	9.88	32.4	0.053	0.057	1.35	1.45	4.60	6.84
M81044/12-18-*	18	19/30	6.23	20.4	0.063	0.067	1.60	1.70	7.00	10.4
M81044/12-16-*	16	19/29	4.81	15.8	0.069	0.075	1.75	1.91	8.90	13.2
M81044/12-14-*	14	19/27	3.06	10.0	0.085	0.093	2.16	2.36	13.9	20.7
M81044/12-12-*	12	37/28	2.02	6.63	0.104	0.112	2.64	2.84	21.7	32.3

MIL-W-81044/13 Lightweight Wall



CONDUCTOR: Stranded silver-coated high strength copper alloy.
 INSULATION: 150° C, cross-linked extruded polyalkene.
 JACKET: Cross-linked extruded polyvinylidene fluoride.
 VOLTAGE: 600 V

Military Part No.	AWG Size	Stranding	Max. Resistance @ 20° C (@ 68° F)		Diameter (minimum - maximum)				Weight Maximum	
			(ohms / 1000 ft)	(ohms / km)	(in)	(mm)			(lbs / 1000 ft)	(kgs / km)
M81044/13-30-*	30	7/38	117.4	385.2	0.025	0.029	0.635	0.737	0.71	1.1
M81044/13-28-*	28	7/36	74.4	244	0.028	0.032	0.711	0.813	0.96	1.4
M81044/13-26-*	26	19/38	44.8	147	0.032	0.036	0.813	0.914	1.4	2.1
M81044/13-24-*	24	19/36	28.4	93.2	0.038	0.042	0.965	1.07	2.1	3.1
M81044/13-22-*	22	19/34	17.5	57.4	0.045	0.049	1.14	1.24	3.1	4.6
M81044/13-20-*	20	19/32	10.7	35.1	0.053	0.057	1.35	1.45	4.6	6.8

* The asterisks in the part number columns are to be replaced by numeric color code designations in accordance with MIL-STD-681D as shown in Color Code Chart No. 6 on page 33.

California

1959 East Cashdan Street, Rancho Dominguez, CA 90220
 (310) 609-1811 • (800) 326-0006 • FAX: (310) 609-1862
 E-Mail: salesrd@std-wire.com

Arizona

3120 West Thomas Road, Bldg. #801, Phoenix, AZ 85017
 (602) 269-2501 • (800) 325-6478 • FAX: (602) 278-7134
 E-Mail: salesphx@std-wire.com



Standard Wire & Cable Co.

MIL-W-81381/7



CONDUCTOR: Stranded silver-coated copper. VOLTAGE: 600 V

INSULATION: -65° C to 200° C, polyimide / FEP laminated tapes, modified aromatic polyimide resin coating 0.0005" minimum, lightweight.

Military Part No.	AWG Size	Stranding	Max. Resistance @ 20° C (@ 68° F)		Diameter (minimum - maximum)		Weight Maximum	
			(ohms / 1000 ft)	(ohms / km)	(in)	(mm)	(lbs / 1000 ft)	(kgs / km)
M81381/7-26-*	26	19/38	38.4	126	0.031 - 0.034	0.787 - 0.864	1.3	1.9
M81381/7-24-*	24	19/36	24.3	79.7	0.034 - 0.037	0.864 - 0.940	1.9	2.8
M81381/7-22-*	22	19/34	15.1	49.5	0.041 - 0.044	1.04 - 1.12	2.8	4.2
M81381/7-20-*	20	19/32	9.19	30.2	0.049 - 0.052	1.24 - 1.32	4.3	6.4
M81381/7-18-*	18	19/30	5.79	19.0	0.059 - 0.062	1.50 - 1.57	6.5	9.7
M81381/7-16-*	16	19/29	4.52	14.8	0.065 - 0.068	1.65 - 1.73	8.3	12
M81381/7-14-*	14	19/27	2.88	9.45	0.078 - 0.082	1.98 - 2.08	12.7	18.9
M81381/7-12-*	12	37/28	1.90	6.23	0.097 - 0.101	2.46 - 2.57	19.4	28.9
M81381/7-10-*	10	37/26	1.19	3.90	0.120 - 0.124	3.05 - 3.15	30.3	45.1

MIL-W-81381/8



CONDUCTOR: Stranded nickel-coated copper. VOLTAGE: 600 V

INSULATION: -65° C to 200° C, polyimide / FEP laminated tapes, modified aromatic polyimide resin coating 0.0005" minimum, lightweight.

Military Part No.	AWG Size	Stranding	Max. Resistance @ 20° C (@ 68° F)		Diameter (minimum - maximum)		Weight Maximum	
			(ohms / 1000 ft)	(ohms / km)	(in)	(mm)	(lbs / 1000 ft)	(kgs / km)
M81381/8-26-*	26	19/38	42.2	138	0.031 - 0.034	0.787 - 0.864	1.4	2.1
M81381/8-24-*	24	19/36	25.9	85.0	0.034 - 0.037	0.864 - 0.940	2.0	3.0
M81381/8-22-*	22	19/34	16.0	52.5	0.041 - 0.044	1.04 - 1.12	3.0	4.5
M81381/8-20-*	20	19/32	9.77	32.1	0.049 - 0.052	1.24 - 1.32	4.5	6.7
M81381/8-18-*	18	19/30	6.10	20.0	0.059 - 0.062	1.50 - 1.57	6.8	10
M81381/8-16-*	16	19/29	4.76	15.6	0.065 - 0.068	1.65 - 1.73	8.5	13
M81381/8-14-*	14	19/27	3.00	9.84	0.078 - 0.082	1.98 - 2.08	13.2	19.6
M81381/8-12-*	12	37/28	1.98	6.50	0.097 - 0.101	2.46 - 2.57	20.2	30.1
M81381/8-10-*	10	37/26	1.24	4.07	0.120 - 0.124	3.05 - 3.15	31.7	47.2

* The asterisks in the part number columns are to be replaced by numeric color code designations in accordance with MIL-STD-681D as shown in Color Code Chart No. 6 on page 33, except that opaque dark yellow as defined in MIL-W-81381 shall be designated by the letter "N" and unpigmented polyimide resin coating shall be designated by the letter "C".

California

1959 East Cashdan Street, Rancho Dominguez, CA 90220
(310) 609-1811 • (800) 326-0006 • FAX: (310) 609-1862
E-Mail: salesrd@std-wire.com

Arizona

3120 West Thomas Road, Bldg. #801, Phoenix, AZ 85017
(602) 269-2501 • (800) 325-6478 • FAX: (602) 278-7134
E-Mail: salesphx@std-wire.com



Standard Wire & Cable Co.

MIL-W-81381/9

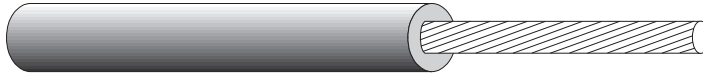

CONDUCTOR: Stranded silver-coated high strength copper.

VOLTAGE: 600 V

INSULATION: -65° C to 200° C, polyimide / FEP laminated tapes, modified aromatic polyimide resin coating 0.0005" minimum, lightweight.

Military Part No.	AWG Size	Stranding	Max. Resistance @ 20° C (@ 68° F)		Diameter (minimum - maximum)		Weight Maximum	
			(ohms / 1000 ft)	(ohms / km)	(in)	(mm)	(lbs / 1000 ft)	(kgs / km)
M81381/9-30-*	30	7/38	117.4	385.2	0.023 - 0.026	0.584 - 0.660	0.6	0.9
M81381/9-28-*	28	7/36	74.4	244	0.026 - 0.029	0.660 - 0.737	0.9	1
M81381/9-26-*	26	19/38	44.8	147	0.031 - 0.034	0.787 - 0.864	1.3	1.9
M81381/9-24-*	24	19/36	28.4	93.2	0.034 - 0.037	0.864 - 0.940	1.9	2.8
M81381/9-22-*	22	19/34	17.5	57.4	0.041 - 0.044	1.04 - 1.12	2.9	4.3
M81381/9-20-*	20	19/32	10.7	35.1	0.049 - 0.052	1.24 - 1.32	4.4	6.5

MIL-W-81381/11



CONDUCTOR: Stranded silver-coated copper.

VOLTAGE: 600 V

INSULATION: -65° C to 200° C, polyimide / FEP laminated tapes, wrapped and heat sealed. Modified aromatic polyimide resin topcoat applied for sizes 10 AWG and smaller. Bright aromatic polyamide braid with clear finisher coating used for 8 AWG and larger, medium weight.

Military Part No.	AWG Size	Stranding	Max. Resistance @ 20° C (@ 68° F)		Diameter (minimum - maximum)		Weight Maximum	
			(ohms / 1000 ft)	(ohms / km)	(in)	(mm)	(lbs / 1000 ft)	(kgs / km)
M81381/11-24-*	24	19/36	24.3	79.7	0.040 - 0.044	1.02 - 1.12	2.1	3.1
M81381/11-22-*	22	19/34	15.1	49.5	0.045 - 0.049	1.14 - 1.24	3.0	4.5
M81381/11-20-*	20	19/32	9.19	30.2	0.053 - 0.057	1.35 - 1.45	4.6	6.8
M81381/11-18-*	18	19/30	5.79	19.0	0.063 - 0.067	1.60 - 1.70	7.0	10
M81381/11-16-*	16	19/29	4.52	14.8	0.068 - 0.073	1.73 - 1.85	8.7	13
M81381/11-14-*	14	19/27	2.88	9.45	0.081 - 0.086	2.06 - 2.18	13.2	19.6
M81381/11-12-*	12	37/28	1.90	6.23	0.100 - 0.105	2.54 - 2.67	20.2	30.1
M81381/11-10-*	10	37/26	1.19	3.90	0.122 - 0.127	3.10 - 3.23	31.1	46.3
M81381/11-8-*	8	133/29	0.658	2.16	0.188 - 0.206	4.78 - 5.23	61.8	92.0
M81381/11-6-*	6	133/27	0.418	1.37	0.228 - 0.251	5.79 - 6.38	95.1	142
M81381/11-4-*	4	133/25	0.264	0.866	0.280 - 0.306	7.11 - 7.77	148	220
M81381/11-2-*	2	665/30	0.170	0.558	0.350 - 0.378	8.89 - 9.60	235	350

* The asterisks in the part number columns are to be replaced by numeric color code designations in accordance with MIL-STD-681D as shown in Color Code Chart No. 6 on page 33, except that opaque dark yellow as defined in MIL-W-81381 shall be designated by the letter "N" and unpigmented polyimide resin coating shall be designated by the letter "C".

California

1959 East Cashdan Street, Rancho Dominguez, CA 90220
(310) 609-1811 • (800) 326-0006 • FAX: (310) 609-1862
E-Mail: salesrd@std-wire.com

Arizona

3120 West Thomas Road, Bldg. #801, Phoenix, AZ 85017
(602) 269-2501 • (800) 325-6478 • FAX: (602) 278-7134
E-Mail: salesphx@std-wire.com



Standard Wire & Cable Co.

MIL-W-81381/12

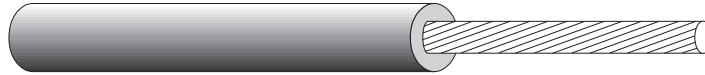

CONDUCTOR: Stranded nickel-coated copper. VOLTAGE: 600 V

INSULATION: -65° C to 200° C, polyimide / FEP laminated tapes, wrapped and heat sealed. Modified aromatic polyimide resin topcoat applied for sizes 10 AWG and smaller. Bright aromatic polyamide braid with clear finisher coating used for 8 AWG and larger, medium weight.

Military Part No.	AWG Size	Stranding	Max. Resistance @ 20° C (@ 68° F)		Diameter (minimum - maximum)		Weight Maximum	
			(ohms / 1000 ft)	(ohms / km)	(in)	(mm)	(lbs / 1000 ft)	(kgs / km)
M81381/12-24-*	24	19/36	25.9	85.0	0.040 - 0.045	1.02 - 1.14	2.2	3.3
M81381/12-22-*	22	19/34	16.0	52.5	0.045 - 0.050	1.14 - 1.27	3.2	4.8
M81381/12-20-*	20	19/32	9.77	32.1	0.053 - 0.058	1.35 - 1.47	4.8	7.1
M81381/12-18-*	18	19/30	6.10	20.0	0.063 - 0.068	1.60 - 1.73	7.2	11
M81381/12-16-*	16	19/29	4.76	15.6	0.068 - 0.074	1.73 - 1.88	9.0	13
M81381/12-14-*	14	19/27	3.00	9.84	0.081 - 0.087	2.06 - 2.21	13.8	20.5
M81381/12-12-*	12	37/28	1.98	6.50	0.100 - 0.107	2.54 - 2.72	20.9	31.1
M81381/12-10-*	10	37/26	1.24	4.07	0.122 - 0.129	3.10 - 3.28	32.4	48.2
M81381/12-8-*	8	133/29	0.694	2.28	0.188 - 0.206	4.78 - 5.23	61.8	92.0
M81381/12-6-*	6	133/27	0.436	1.43	0.228 - 0.251	5.79 - 6.38	95.1	142
M81381/12-4-*	4	133/25	0.275	0.902	0.280 - 0.306	7.11 - 7.77	148	220
M81381/12-2-*	2	665/30	0.177	0.581	0.350 - 0.378	8.89 - 9.60	235	350

MIL-W-81381/13



CONDUCTOR: Stranded silver-coated high strength copper alloy. VOLTAGE: 600 V

INSULATION: -65° C to 200° C, polyimide / FEP laminated tapes, modified aromatic polyimide resin coating 0.0005" minimum, medium weight.

Military Part No.	AWG Size	Stranding	Max. Resistance @ 20° C (@ 68° F)		Diameter (minimum - maximum)		Weight Maximum	
			(ohms / 1000 ft)	(ohms / km)	(in)	(mm)	(lbs / 1000 ft)	(kgs / km)
M81381/13-28-*	28	7/36	74.4	244	0.031 - 0.035	0.79 - 0.89	1.2	1.8
M81381/13-26-*	26	19/38	44.8	147	0.036 - 0.040	0.91 - 1.02	1.5	2.2
M81381/13-24-*	24	19/36	28.4	93.2	0.041 - 0.045	1.04 - 1.14	2.2	3.3
M81381/13-22-*	22	19/34	17.5	57.4	0.047 - 0.051	1.19 - 1.30	3.1	4.6
M81381/13-20-*	20	19/32	10.7	35.1	0.055 - 0.059	1.40 - 1.50	4.8	7.1

* The asterisks in the part number columns are to be replaced by numeric color code designations in accordance with MIL-STD-681D as shown in Color Code Chart No. 6 on page 33, except that opaque dark yellow as defined in MIL-W-81381 shall be designated by the letter "N" and unpigmented polyimide resin coating shall be designated by the letter "C".

California

1959 East Cashdan Street, Rancho Dominguez, CA 90220
(310) 609-1811 • (800) 326-0006 • FAX: (310) 609-1862
E-Mail: salesrd@std-wire.com

Arizona

3120 West Thomas Road, Bldg. #801, Phoenix, AZ 85017
(602) 269-2501 • (800) 325-6478 • FAX: (602) 278-7134
E-Mail: salesphx@std-wire.com



Standard Wire & Cable Co.

MIL-W-81381/17



CONDUCTOR: Stranded silver-coated copper. VOLTAGE: 600 V
 INSULATION: -65° C to 200° C, polyimide / FEP laminated tapes, modified aromatic polyimide resin coating 0.001" minimum, lightweight.

Military Part No.	AWG Size	Stranding	Max. Resistance @ 20° C (@ 68° F)		Diameter (minimum - maximum)		Weight Maximum	
			(ohms / 1000 ft)	(ohms / km)	(in)	(mm)	(lbs / 1000 ft)	(kgs / km)
M81381/17-26-*	26	19/38	38.4	126	0.028 - 0.030	0.711 - 0.762	1.2	1.8
M81381/17-24-*	24	19/36	24.3	79.7	0.032 - 0.035	0.813 - 0.889	1.8	2.7
M81381/17-22-*	22	19/34	15.1	49.5	0.038 - 0.041	0.965 - 1.04	2.7	4.0
M81381/17-20-*	20	19/32	9.19	30.2	0.046 - 0.049	1.168 - 1.24	4.2	6.2
M81381/17-18-*	18	19/30	5.79	19.0	0.055 - 0.058	1.40 - 1.47	6.4	9.5
M81381/17-16-*	16	19/29	4.52	14.8	0.062 - 0.065	1.57 - 1.65	8.0	12
M81381/17-14-*	14	19/27	2.88	9.45	0.075 - 0.078	1.91 - 1.98	12.5	18.6
M81381/17-12-*	12	37/28	1.90	6.23	0.094 - 0.098	2.39 - 2.49	19.2	28.6

MIL-W-81381/21



CONDUCTOR: Stranded tin-coated copper. VOLTAGE: 600 V
 INSULATION: -65° C to 200° C, polyimide / FEP laminated tapes, modified aromatic polyimide resin coating 0.0005" minimum, lightweight.

Military Part No.	AWG Size	Stranding	Max. Resistance @ 20° C (@ 68° F)		Diameter (minimum - maximum)		Weight Maximum	
			(ohms / 1000 ft)	(ohms / km)	(in)	(mm)	(lbs / 1000 ft)	(kgs / km)
M81381/21-26-*	26	19/38	41.3	135	0.030 - 0.034	0.762 - 0.864	1.3	1.9
M81381/21-24-*	24	19/36	26.2	86.0	0.034 - 0.038	0.864 - 0.965	2.0	3.0
M81381/21-22-*	22	19/34	16.2	53.1	0.041 - 0.045	1.04 - 1.14	3.0	4.5
M81381/21-20-*	20	19/32	9.88	32.4	0.048 - 0.053	1.22 - 1.35	4.4	6.5
M81381/21-18-*	18	19/30	6.23	20.4	0.058 - 0.063	1.47 - 1.60	6.6	9.8
M81381/21-16-*	16	19/29	4.81	15.8	0.064 - 0.069	1.63 - 1.75	8.4	12
M81381/21-14-*	14	19/27	3.06	10.0	0.077 - 0.083	1.96 - 2.11	12.8	19.0
M81381/21-12-*	12	37/28	2.02	6.63	0.097 - 0.102	2.46 - 2.59	20.7	30.9
M81381/21-10-*	10	37/26	1.26	4.13	0.120 - 0.125	3.05 - 3.18	32.4	48.2

* The asterisks in the part number columns are to be replaced by numeric color code designations in accordance with MIL-STD-681D as shown in Color Code Chart No. 6 on page 33, except that opaque dark yellow as defined in MIL-W-81381 shall be designated by the letter "N" and unpigmented polyimide resin coating shall be designated by the letter "C".

California

1959 East Cashdan Street, Rancho Dominguez, CA 90220
 (310) 609-1811 • (800) 326-0006 • FAX: (310) 609-1862
 E-Mail: salesrd@std-wire.com

Arizona

3120 West Thomas Road, Bldg. #801, Phoenix, AZ 85017
 (602) 269-2501 • (800) 325-6478 • FAX: (602) 278-7134
 E-Mail: salesphx@std-wire.com



Standard Wire & Cable Co.

MIL-W-81381/22



CONDUCTOR: Stranded tin-coated copper. VOLTAGE: 600 V

INSULATION: -65° C to 150° C, polyimide / FEP laminated tapes, wrapped and heat sealed. Modified aromatic polyimide resin topcoat applied for sizes 10 AWG and smaller. Bright aromatic polyamide braid with clear finisher coating used for 8 AWG and larger, medium weight.

Military Part No.	AWG Size	Stranding	Max. Resistance @ 20° C (@ 68° F)		Diameter (minimum - maximum)		Weight Maximum	
			(ohms / 1000 ft)	(ohms / km)	(in)	(mm)	(lbs / 1000 ft)	(kgs / km)
M81381/22-24-*	24	19/36	26.2	86.0	0.040 - 0.044	1.02 - 1.12	2.2	3.3
M81381/22-22-*	22	19/34	16.2	53.1	0.045 - 0.049	1.14 - 1.24	3.2	4.8
M81381/22-20-*	20	19/32	9.88	32.4	0.053 - 0.058	1.35 - 1.47	4.7	7.0
M81381/22-18-*	18	19/30	6.23	20.4	0.063 - 0.068	1.60 - 1.73	7.0	10
M81381/22-16-*	16	19/29	4.81	15.8	0.068 - 0.074	1.73 - 1.88	8.7	13
M81381/22-14-*	14	19/27	3.06	10.0	0.081 - 0.089	2.06 - 2.26	13.3	19.8
M81381/22-12-*	12	37/28	2.02	6.63	0.100 - 0.107	2.54 - 2.72	20.4	30.4
M81381/22-10-*	10	37/26	1.26	4.13	0.122 - 0.130	3.10 - 3.30	31.5	46.9
M81381/22-8-*	8	133/29	0.701	2.30	0.188 - 0.206	4.78 - 5.23	61.8	92.0
M81381/22-6-*	6	133/27	0.445	1.46	0.228 - 0.251	5.79 - 6.38	95.1	142
M81381/22-4-*	4	133/25	0.280	0.919	0.280 - 0.306	7.11 - 7.77	148	220
M81381/22-2-*	2	665/30	0.183	0.600	0.350 - 0.378	8.89 - 9.60	235	350
M81381/22-01-*	1/0	1,045/30	0.116	0.381	0.425 - 0.461	10.8 - 11.7	374	557
M81381/22-02-*	2/0	1,330/30	0.091	0.299	0.478 - 0.518	12.1 - 13.2	470	699

* The asterisks in the part number column are to be replaced by numeric color code designations in accordance with MIL-STD-681D as shown in Color Code Chart No. 6 on page 33, except that opaque dark yellow as defined in MIL-W-81381 shall be designated by the letter "N" and unpigmented polyimide resin coating shall be designated by the letter "C".

California

1959 East Cashdan Street, Rancho Dominguez, CA 90220
(310) 609-1811 • (800) 326-0006 • FAX: (310) 609-1862
E-Mail: salesrd@std-wire.com

Arizona

3120 West Thomas Road, Bldg. #801, Phoenix, AZ 85017
(602) 269-2501 • (800) 325-6478 • FAX: (602) 278-7134
E-Mail: salesphx@std-wire.com



Standard Wire & Cable Co.

MIL-C-27500 Cable Designation

All MIL-C-27500 cables are designated by a combination of digits and letters (not to exceed 16) which indicates the exact construction of each cable. Please note the following example of a MIL-C-27500 cable.

Cable Description: **M27500A 22 SB 3 T 23** (1) (2) (3) (4) (5) (6) (7)

Classification: The cable will be of the following types and will be furnished in the basic wire size, type, number of wires, and shield and jacket styles, as specified.

Unjacketed: 2 to 15 color coded wires, spirally laid without an overall outer jacket.

Jacketed: 2 to 15 color coded wires, spirally laid with an overall outer jacket.

Shielded: A single wire, or 2 to 15 color coded wires spirally laid, with one or two overall shields.

Shielded and Jacketed: A single wire, or 2 to 15 color coded wires spirally laid, with one or two shields and one or two jackets.

Specification Number (1): All cables will carry this prefix.

Identification Method (2): When 85% minimum shield coverage is required:

"-" designates the preferred identification method using Table IIIA;

"F" designates the preferred identification method using Table IIIB;

"A" designates optional identification method A using Table IIIA;

"G" designates optional identification method A using Table IIIB;

"B" designates optional identification method B using Table IIIC;

"K" designates optional identification method C;

"L" designates optional identification method D (see mil spec for band marking specification).

When 90% minimum shield coverage is required:

"C" designates the preferred identification method using Table IIIA;

"H" designates the preferred identification method using Table IIIB;

"D" designates optional identification method A using Table IIIA;

"J" designates optional identification method A using Table IIIB;

"E" designates optional identification method B using Table IIIC;

"M" designates optional identification method C;

"N" designates optional identification method D (see mil spec for band marking specification).

band

Conductor Size (3): This position identifies the wire size. Wire size depends upon the basic wire specification (see 4).

Basic Wire Specification (4): The component wires are identified by a one or two letter code. A listing of the basic wire specifications can be found in Table I.

Number of Conductors (5): M27500 currently specifies from 1 to 15 conductors for shielded or shielded and jacketed cables, and from 2 to 15 for unshielded unjacketed or unshielded jacketed cables. Cables with 10 to 15 conductors are limited to 12 AWG and smaller.

Shield (6): The specific shield style and material are designated by a single letter code and are detailed in Table I A.

Jacket (7): Cable jacketing materials are specified by a two digit code and are detailed in Table I B.

California

1959 East Cashdan Street, Rancho Dominguez, CA 90220
(310) 609-1811 • (800) 326-0006 • FAX: (310) 609-1862
E-Mail: salesrd@std-wire.com

Arizona

3120 West Thomas Road, Bldg. #801, Phoenix, AZ 85017
(602) 269-2501 • (800) 325-6478 • FAX: (602) 278-7134
E-Mail: salesphx@std-wire.com



Table I - Basic Wire Specifications

A	MIL-W-5086/1 ¹	CA	MIL-W-22759/13	SP	MIL-W-22759/43	MF	MIL-W-81044/7
B	MIL-W-5086/2 ^{1,2}	CB	MIL-W-22759/14	SR	MIL-W-22759/44	MG	MIL-W-81044/8 ²
C	MIL-W-5086/3 ^{1,2}	CC	MIL-W-22759/15	SS	MIL-W-22759/45	MH	MIL-W-81044/9
P	MIL-W-5086/4 ¹	TE	MIL-W-22759/16	ST	MIL-W-22759/46	MJ	MIL-W-81044/10
AA	MIL-W-5086/5 ¹	TF	MIL-W-22759/17	WB	MIL-W-22759/80 ³	MK	MIL-W-81044/11 ²
AB	MIL-W-5086/6 ¹	TG	MIL-W-22759/18	WC	MIL-W-22759/81 ³	ML	MIL-W-81044/12
AD	MIL-W-5086/7 ¹	TH	MIL-W-22759/19	WE	MIL-W-22759/82 ³	MM	MIL-W-81044/13
H	MIL-W-8777, MS 25471	TK	MIL-W-22759/20	WF	MIL-W-22759/83 ³	MR	MIL-W-81381/7 ³
F	MIL-W-8777, MS 27110	TL	MIL-W-22759/21	WG	MIL-W-22759/84 ³	MS	MIL-W-81381/8 ³
EA	MIL-W-22759/1	TM	MIL-W-22759/22	WH	MIL-W-22759/85 ³	MT	MIL-W-81381/9 ³
E	MIL-W-22759/2	TN	MIL-W-22759/23	WJ	MIL-W-22759/86 ³	MV	MIL-W-81381/10 ³
RA	MIL-W-22759/3	JB	MIL-W-22759/28	WK	MIL-W-22759/87 ³	MW	MIL-W-81381/11 ³
RB	MIL-W-22759/4	JC	MIL-W-22759/29	WL	MIL-W-22759/88 ³	MY	MIL-W-81381/12 ³
VA	MIL-W-22759/5	JD	MIL-W-22759/30	WM	MIL-W-22759/89 ³	NA	MIL-W-81381/13 ³
WA	MIL-W-22759/6	JE	MIL-W-22759/31	WN	MIL-W-22759/90 ³	NB	MIL-W-81381/14 ³
SA	MIL-W-22759/7	SB	MIL-W-22759/32	WP	MIL-W-22759/91 ³	NE	MIL-W-81381/17 ³
TA	MIL-W-22759/8	SC	MIL-W-22759/33	WR	MIL-W-22759/92 ³	NF	MIL-W-81381/18 ³
LE	MIL-W-22759/9	SD	MIL-W-22759/34	JA	MIL-W-25038/1	NG	MIL-W-81381/19 ³
LH	MIL-W-22759/10	SE	MIL-W-22759/35	JF	MIL-W-25038/3	NH	MIL-W-81381/20 ³
RC	MIL-W-22759/11	SM	MIL-W-22759/41	MD	MIL-W-81044/5 ²	NK	MIL-W-81381/21 ³
RE	MIL-W-22759/12	SN	MIL-W-22759/42	ME	MIL-W-81044/6	NL	MIL-W-81381/22 ³

¹ Not for use in aerospace applications. ² Inactive for new design. ³ Not for Naval Air Systems Command usage.

Table I A - Shield Material

Letter Code		Description	Maximum temperature limit for shield material	
Single Shield	Double Shield		°C	°F
U	---	No shield	N/A	N/A
T	V	Round, tin-coated copper	150	302
S	W	Round, silver-coated copper	200	392
N	Y	Round, nickel-coated copper	260	500
F	Z	Round, stainless steel	400	752
C	R	Round, heavy nickel-coated copper	400	752
M	K	Round, silver-coated high strength copper alloy	200	392
P	L	Round, nickel-coated high strength copper alloy	260	500
G	A	Flat, silver-coated copper	200	392
H	B	Flat, silver-coated high strength copper alloy	200	392
*	#	Flat, nickel-coated copper	260	500
J	D	Flat, tin-coated copper	150	302
E	X	Flat, nickel-coated high strength copper alloy	260	500
I	Q	Flat, nickel-chromium alloy	400	752

California

1959 East Cashdan Street, Rancho Dominguez, CA 90220
 (310) 609-1811 • (800) 326-0006 • FAX: (310) 609-1862
 E-Mail: salesrd@std-wire.com

Arizona

3120 West Thomas Road, Bldg. #801, Phoenix, AZ 85017
 (602) 269-2501 • (800) 325-6478 • FAX: (602) 278-7134
 E-Mail: salesphx@std-wire.com



Standard Wire & Cable Co.

Table I B - Jacket Material and Color

Numeric Code		Description	Temperature limit for jacket material	
Single Jacket	Double Jacket		°C	°F
00	00	No jacket	N/A	N/A
01	51 ¹	Extruded white polyvinylchloride (PVC)	90	194
02 ²	52 ²	Extruded clear polyamide in accordance with ASTM-D-4066	105	221
03	53	White polyamide braid impregnated with clear polyamide finisher over a polyester tape	105	221
04	54	Polyester braid impregnated with high temperature finishers over polyester tape	150	302
05	55	Extruded clear fluorinated ethylene propylene (FEP)	200	392
06	56	Extruded or taped and heat sealed white polytetrafluoroethylene (PTFE)	260	500
07	57	White polytetrafluoroethylene (PTFE) treated glass braid impregnated and coated with polytetrafluoroethylene finisher over presintered polytetrafluoroethylene tape	260	500
08 ³	58 ³	Cross-linked white extruded polyvinylidene fluoride (PVDF ₂)	150	302
09	59	Extruded white fluorinated ethylene propylene (FEP)	200	392
10 ³	60 ³	Extruded clear polyvinylidene fluoride (PVDF ₂)	125	257
11 ⁴	61 ⁴	Tape of natural polyimide combined with clear fluorinated ethylene propylene (FEP) wrapped and heat sealed with (FEP) outer surface	200	392
12 ⁴	62 ⁴	Tape of natural polyimide combined with fluorinated ethylene propylene (FEP) wrapped and heat sealed with polyimide outer surface	200	392
14	64	Extruded white ethylene-tetrafluoroethylene copolymer (ETFE)	150	302
15	65	Extruded clear ethylene-tetrafluoroethylene copolymer (ETFE)	150	302
16	66	Braid of aromatic polyamide with high temperature finisher over presintered polytetrafluoroethylene (PTFE) tape	200	392
17 ⁵	67 ⁵	Extruded white ethylene chlorotrifluoroethylene (ECTFE)	150	302
18 ⁵	68 ⁵	Extruded clear ethylene chlorotrifluoroethylene (ECTFE)	150	302
20	70	Extruded white perfluoroalkoxy (PFA)	260	500
21	71	Extruded clear perfluoroalkoxy (PFA)	260	500
22	72	Tape of polyimide combined with clear fluorinated ethylene propylene (FEP) wrapped and heat sealed with opaque polyimide outer surface	200	392
23	73	Extruded white cross-linked modified ethylene-tetrafluoroethylene copolymer (XLETFE)	200	392
24	74	Tape layer of white polytetrafluoroethylene (PTFE) wrapped over a tape layer of natural polyimide combined with FEP and heat sealed	200	392

¹ Polyvinylchloride (PVC) materials shall not be used for aerospace applications.

² Jacket material 02/52 is not to be used for cables having a diameter of 0.251 in (6.38 mm) or greater.

³ Jacket materials 08, 10, 58, and 60 are not to be used for cables having a diameter of 0.401 in (10.19 mm) or greater.

⁴ Not for Naval Air Systems Command usage.

⁵ Inactive for new design.

California

1959 East Cashdan Street, Rancho Dominguez, CA 90220
 (310) 609-1811 • (800) 326-0006 • FAX: (310) 609-1862
 E-Mail: salesrd@std-wire.com

Arizona

3120 West Thomas Road, Bldg. #801, Phoenix, AZ 85017
 (602) 269-2501 • (800) 325-6478 • FAX: (602) 278-7134
 E-Mail: salesphx@std-wire.com



Table II - Allowable Shield and Jacket Materials for Each Basic Type Wire

Basic Wire Specification	Cable Type					
	Shielded		Jacketed		Shielded and Jacketed	
	Shield Material ¹	Jacket Material	Shield Material	Jacket Material	Shield Material ¹	Jacket Material
MIL-W-5086	T	00	Unshielded	01, 02, 03, 10	T	01, 02, 03, 10
MIL-W-8777	S	00	Unshielded	04	S	04
MIL-W-22759 slash sheets 1-12,20-23, 28-31	T, S, N	00	Unshielded	04, 05, 06, 07, 09, 14-18, 20, 21	T, S, N	04, 05, 06, 07, 09, 14-18, 20, 21
MIL-W-22759 slash sheets 13-19	T, S, N	00	Unshielded	04, 05, 09, 14-18, 20, 21	T, S, N	04, 05, 09, 14-18, 20, 21
MIL-W-22759 slash sheets 32-35, 41-46	T, S, N	00	Unshielded	04, 05, 08, 09, 14-18, 20, 21, 23, 24	T, S, N	04, 05, 08, 09, 14-18, 20, 21, 23, 24
MIL-W-22759 slash sheets 80-92	T, S, N	00	Unshielded	04, 05, 06, 07, 09, 11, 12, 14-18, 20, 21, 22, 24	T, S, N	04, 05, 06, 07, 09, 11, 12, 14-18, 20, 21, 22, 24
MIL-W-25038/1 & /3	F, C	00	Unshielded	06, 07	F, C	06, 07
MIL-W-81044	T,S	00	Unshielded	04, 08, 09, 14, 16, 23	T,S	04, 08, 09, 14, 16, 23
MIL-W-81381	T, S, N	00	Unshielded	05, 09, 11, 12, 22	T, S, N	05, 09, 11, 12, 22

See Table I A and Table I B for jacket material cross-reference.

¹ T = Tin, S = Silver, N = Nickel, F = Stainless steel, C = Heavy coated nickel

Table III C - Color of Insulation for Identification of Wire Sizes in accordance with MIL-STD-686

Wire Size	26 ¹	24	22	20	18	16	14	12	10	8	6	4	2	1	1/0	2/0
Insulation Color (solid)	Black	Blue	Green	Red	White ²	Blue	Green	Yellow	Brown	Red	Blue	Yellow	Red	White	Blue	Green

¹ 26 AWG is inactive for new design.

² For MIL-W-81381 basic wire, the insulation color may be opaque dark yellow or unpigmented polyimide resin color.

California

1959 East Cashdan Street, Rancho Dominguez, CA 90220
 (310) 609-1811 • (800) 326-0006 • FAX: (310) 609-1862
 E-Mail: salesrd@std-wire.com

Arizona

3120 West Thomas Road, Bldg. #801, Phoenix, AZ 85017
 (602) 269-2501 • (800) 325-6478 • FAX: (602) 278-7134
 E-Mail: salesphx@std-wire.com



Standard Wire & Cable Co.

**Table III A - Circuit Identification Colors for Basic Wires in Cable
in accordance with MIL-W-22759, MIL-W-25038, MIL-W-81044, or MIL-W-81381**

No. of Wires in Cable	Wire Number														
	1	2	3	4	5	6	7	8	9	10	11	12	13	14	15
1	Basic (white)														
2	White ¹	Blue													
3	White ¹	Blue	Orange												
4	White ¹	Blue	Orange	Green											
5	White ¹	Blue	Orange	Green	Red										
6	White ¹	Blue	Orange	Green	Red	Black									
7	White ¹	Blue	Orange	Green	Red	Black	Yellow ²								
8	White ¹	Blue	Orange	Green	Red	Black	Yellow ²	Violet							
9	White ¹	Blue	Orange	Green	Red	Black	Yellow ²	Violet	Gray						
10	White ¹	Blue	Orange	Green	Red	Black	Yellow ²	Violet	Gray	Brown ³					
11 ⁴	White ¹	Blue	Orange	Green	Red	Black	Yellow ²	Violet	Gray	Brown ³	Blue/Blue				
12 ⁴	White ¹	Blue	Orange	Green	Red	Black	Yellow ²	Violet	Gray	Brown ³	Blue/Blue	Orange/Orange			
13 ⁴	White ¹	Blue	Orange	Green	Red	Black	Yellow ²	Violet	Gray	Brown ³	Blue/Blue	Orange/Orange	Green/Green		
14 ⁴	White ¹	Blue	Orange	Green	Red	Black	Yellow ²	Violet	Gray	Brown ³	Blue/Blue	Orange/Orange	Green/Green	Red/Red	
15 ⁴	White ¹	Blue	Orange	Green	Red	Black	Yellow ²	Violet	Gray	Brown ³	Blue/Blue	Orange/Orange	Green/Green	Red/Red	Black/Black

¹ Except where preferred color on basic wire specification sheet is not white.

² Where basic wire is MIL-W-81381, a brown helical stripe shall be used.

³ Where basic wire is MIL-W-81381, a brown and white helical stripes shall be used.

⁴ For cables having more than 10 conductors, the wires shall be a white base identified by double color tracers as indicated.

**Table III B - Circuit Identification Colors for Basic Wires in Cable
in accordance with MIL-W-5086 ¹, MIL-W-8777, MIL-W-22759, MIL-W-25038, MIL-W-81044, or MIL-W-81381**

No. of Wires in Cable	Identification Colors for Respective Wires in Cable
1	Basic (white)
2	Red, blue
3	Red, blue, yellow
4	Red, blue, yellow, green
5	Red, blue, yellow, green, basic
6	Red, blue, yellow, green, basic, black
7	Red, blue, yellow, green, basic, black, brown
8	Red, blue, yellow, green, basic, black, brown, orange
9	Red, blue, yellow, green, basic, black, brown, orange, violet
10	Red, blue, yellow, green, basic, black, brown, orange, violet, gray
11	Red, blue, yellow, green, basic, black, brown, orange, violet, gray, red/white ²
12	Red, blue, yellow, green, basic, black, brown, orange, violet, gray, red/white ² , blue/white ²
13	Red, blue, yellow, green, basic, black, brown, orange, violet, gray, red/white ² , blue/white ² , yellow/white ²
14	Red, blue, yellow, green, basic, black, brown, orange, violet, gray, red/white ² , blue/white ² , yellow/white ² , green/white ²
15	Red, blue, yellow, green, basic, black, brown, orange, violet, gray, red/white ² , blue/white ² , yellow/white ² , green/white ² , black/white ²

¹ Inactive for new design for MIL-W-5086.

² Color designation indicates a solid color with stripe, e.g., red/white - solid red insulation with a white stripe.

California

1959 East Cashdan Street, Rancho Dominguez, CA 90220
(310) 609-1811 • (800) 326-0006 • FAX: (310) 609-1862
E-Mail: salesrd@std-wire.com

Arizona

3120 West Thomas Road, Bldg. #801, Phoenix, AZ 85017
(602) 269-2501 • (800) 325-6478 • FAX: (602) 278-7134
E-Mail: salesphx@std-wire.com



COAXIAL CABLE

THEORY AND APPLICATION

Transmission of electrical signals over wire lines requires the use of two conductors to complete the circuit. One we call the "go" wire; the other is the "return" wire.

For the purpose of explaining coaxial cable, let's examine a telephone installation using conventional wire. The wires are paired on telephone poles; one pair is used for each telephone circuit. On some circuits, only the "go" wire is mounted on the pole and the earth itself is used as the "return". Sometimes the pairs of wires for telephone circuits are bundled together in groups of up to 1,800 pairs (3,600 separate wires) and are then jacketed to form a "multi-pair cable".

In all of these arrangements the wires carrying the very delicate electrical currents conveying the telephone conversation are exposed to external interference. Lightning, although it may not strike the wires directly, will cause static. Wet weather can cause leakage across insulators, giving a "frying" noise in your telephone receiver, and faults on power transmission lines can cause pops and loud hums that interfere with the conversation. The proximity of other wire pairs carrying conversations to your pair, particularly in multi-pair cables, may cause you to faintly hear another conversation in the background. This is called "cross talk".

There are two other problems related to the use of the conventional pair of wires for communication. One is that this type of circuit has a high "attenuation", that is, the signals get weaker as they travel along the wires and on a long-distance line, amplifiers are necessary to boost the conversation every few miles so that the conversation will not get lost below the line noise.

The other problem, and economically the most important, is that of "bandwidth". A telephone conversation can just satisfactorily be carried on if the circuit transmits audible tones in the range from about 300 hertz (Hz) to about 2,500 Hz, a total "band" of 2,200 Hz. It is possible to carry more than one conversation

simultaneously on a pair of wires by "frequency multiplexing" the conversations.

One conversation will occupy frequencies of 300 to 2,500 Hz, the next from 3,000 to 5,200, the next from 5,700 to 7,900, and so on. Each conversation requires 2,200 Hz and there is a "guard band" of at least 500 Hz between each conversation to prevent their mixing. Each of these signals is reconverted at the receiving end of the line to the 300 to 2,500 Hz range before they appear at a telephone receiver. We can not keep adding to the number of conversations that a pair of wires can carry simultaneously because of the relatively low upper limit of frequency that this system of conventional wires can transmit. Coaxial cable was developed to alleviate the foregoing problems.

In coaxial cable, the "go" wire is the center conductor, some form of copper wire, solid or stranded, of comparatively small diameter, around which is a very heavy insulation - the dielectric. But the "return" wire is no longer another identical wire. Instead it is in the form of a copper tube completely surrounding the "go" wire and dielectric, and concentric with it; hence, the term "coaxial". Thus, no external interference can affect your conversation (in the case of telephone usage) because it is carried by currents completely shielded from external effects by the tubular "return" conductor. Effects of weather are also excluded.

Coaxial cable has an extremely broad bandwidth; it will transmit signals from zero frequency (direct current) up to many millions of hertz. Literally, hundreds of conversations (or messages) can be frequency multiplexed and transmitted simultaneously over a single coaxial cable, or a television program occupying about 3,500,000 Hz can be transmitted simultaneously with hundreds of phone conversations.

Coaxial cable, since it has a low attenuation, does not need as many amplifiers as when using conventional wire. Those that are required are relatively inexpensive as they simultaneously boost all the hundreds of signals on the cable.

California

1959 East Cashdan Street, Rancho Dominguez, CA 90220
(310) 609-1811 • (800) 326-0006 • FAX: (310) 609-1862
E-Mail: salesrd@std-wire.com

Arizona

3120 West Thomas Road, Bldg. #801, Phoenix, AZ 85017
(602) 269-2501 • (800) 325-6478 • FAX: (602) 278-7134
E-Mail: salesphx@std-wire.com



Standard Wire & Cable Co.

Besides its importance in the telephone industry, all the major manufacturers of radio, television, radar, navigation aids, fire control, aircraft, shipbuilding, underwater sound, and many other types of transmitting equipment use coaxial cable. The cable TV and closed circuit TV systems use miles of this type cable. Sophisticated cable TV systems, for example, use a large diameter single or double shielded cable as a main transmission line, with tap-offs of smaller sizes for a secondary lead-in; a third size, even smaller, carries the televised signal directly into the receiver.

The uses of coaxial cable extend to any application in which signal loss and attenuation must be kept to a minimum, or in which the elimination of outside interference is important. Another application is its utilization in various systems of instrumentation. Combining many coaxial cables under one jacket to form an integral unit is used in the computerized instrumentation field.

PTFE (polytetrafluoroethylene) insulated high temperature coaxial cable is used by aircraft and missile manufacturers, in high temperature applications, and in products where protection is desired against strong alkalis and acids or other highly corrosive fluids.

How are coaxial cables identified? Only cables made strictly to U.S. Government specifications can be marked with the RG legend. The meanings of the abbreviations of this legend are as follows:

- R** - **RADIO FREQUENCY**
- G** - **GOVERNMENT**
- 8** - **Is the number assigned to the Government approval**
- U** - **A universal specification**

If the letters A, B, or C appear before the /, it means a specification modification or revision. For example - RG 8/U is superseded by RG 8A/U but both types are still being used.

Types not marked RG are primarily intended for use where the application is not met by some government type. There are many other types of cables designed for specific applications. These are identified in various ways by each individual manufacturer.

DEFINITIONS

1. **ATTENUATION** - Attenuation is loss of power or signal expressed in decibels; it is commonly written and spoken of as dB/100 ft. *at a specific frequency.* An example is RG 8A/U which has a loss of 5.5 dB/100 ft. at 400 MHz.

2. **FREQUENCY** - Frequency is the term designating the number of reverses or cycles in the flow of alternating current (AC) in one second. For example, the frequency of AC commonly used in the U.S. is 60 hertz and is usually shown as 60 Hz. Broadcast stations operate at frequencies of thousands of cycles per second and their frequencies are called kilohertz (kHz). Your AM radio dial represents frequencies in kilohertz (kHz). High frequencies are in millions of cycles per second and are called megahertz (MHz). TV is broadcast in the MHz range.

3. **IMPEDANCE** - Impedance is a term expressing the ratio of voltage to current in a cable of infinite length. In the case of coaxial cables, impedance is expressed in terms of "ohms impedance". The coaxial cables generally fall into three main classes; 50 ohms, 75 ohms, and 95 ohms.

An example of each class is:

- RG 8A/U 50 ohms impedance
- RG 11A/U 75 ohms impedance
- RG 22B/U 95 ohms impedance

4. **CAPACITANCE (CAPACITY)** - Capacitance or capacity is the property of a system of conductors and dielectrics which permits the storage of electricity when a potential or voltage difference exists between the two conductors. A capacity value is expressed in farads. When we deal with coaxial cable, the capacity ranges we have are very small and are expressed in picofarads (pF). Capacity is the major factor governing impedance. Examples of cables with typical impedances have capacity as follows:

California

1959 East Cashdan Street, Rancho Dominguez, CA 90220
(310) 609-1811 • (800) 326-0006 • FAX: (310) 609-1862
E-Mail: salesrd@std-wire.com

Arizona

3120 West Thomas Road, Bldg. #801, Phoenix, AZ 85017
(602) 269-2501 • (800) 325-6478 • FAX: (602) 278-7134
E-Mail: salesphx@std-wire.com



Standard Wire & Cable Co.

RG or M17/	Cable Impedance (ohms)	Dielectric Type	Capacitance (pF / ft)
RG 8A/U	50	PE	29.5
RG 231A/U	50	Foam PE	25.0
RG 188A/U	50	Solid TFE	29.0
M17/6	75	PE	20.6
RG 306A/U	75	Foam PE	16.5
RG 140	75	Solid TFE	21.0
M17/90	93	Air space PE	13.5
M17/56	95	PE	17.0
M17/95	95	Solid PTFE	15.4
RG 24A/U	125	PE	12.0
RG 114A/U	185	Air space PE	6.5

5. VELOCITY OF PROPAGATION - Velocity of propagation, commonly called velocity, is the ratio of the speed of the flow of an electric current in an insulated cable to the speed of light. All insulated cables have this ratio and it is expressed in a percentage. In the case of coaxial cables with polyethylene dielectric, this ratio is in the range of 65% - 66%.

In selecting coaxial cable, we must carefully consider not only design criteria, but use and application. Selection of materials in relation to overall design considerations is tabulated in Tables 1 through 4, below:

	INNER CONDUCTORS					
	SOFT BARE COPPER	TINNED SOFT COPPER	SILVER- PLATED COPPER	NICKEL- PLATED COPPER	TINNED- CADIMUM BRONZE	COPPER- WELD®
Maximum operating temperature °C	200	150	200	250	150	200
Resistivity at 20°C, ohms - circular mil / ft.	10.371	11.133	10.371	12.50	11.92	25.928
Average tensile strength psi (1,000)	37	37	37.5	37.5	45	130
Flexibility	excellent	excellent	excellent	excellent	good	good
Remarks	most popular - for extra flexibility use stranded	for added resistance to oxidation and easy solderability, best for low frequency application	elevated temperature use in aircraft, missile, and electronics, easy solderability	extra high temperature use	high tensile strength with flexibility	extra high tensile strength

TABLE 1 - Inner Conductors

Copperweld® is a trademark of the Copperweld Steel Company.

California

1959 East Cashdan Street, Rancho Dominguez, CA 90220
 (310) 609-1811 • (800) 326-0006 • FAX: (310) 609-1862
 E-Mail: salesrd@std-wire.com

Arizona

3120 West Thomas Road, Bldg. #801, Phoenix, AZ 85017
 (602) 269-2501 • (800) 325-6478 • FAX: (602) 278-7134
 E-Mail: salesphx@std-wire.com



Standard Wire & Cable Co.

	OUTER CONDUCTORS				
	SOFT BARE COPPER	TINNED SOFT COPPER	SILVER-PLATED COPPER	ALUMINUM TUBE	COPPER TUBE
Maximum operating temperature °C	200	150	200	-	-
Flexibility	excellent	excellent	excellent	poor	poor
Remarks	most popular in braid, minimum .004" to .010", add second shield to improve flexibility	most popular in braid, minimum .004" to .010", add second shield to improve flexibility, better for low frequency	most popular in braid, minimum .004" to .010", add second shield to improve flexibility, for high temperature	for high tensile and crushing loads and lower attenuation	for high tensile strength and crushing loads

TABLE 2 - Outer Conductors

	PRIMARY DIELECTRICS				
	POLYETHYLENE (PE)	FOAMED POLYETHYLENE (PE)	TEFLON® (FEP)	TEFLON® (TFE)	BUTYL RUBBER
Operating temperature range °C	-65 to 80	-65 to 80	-65 to 200	-65 to 260	-40 to 80
Average tensile strength psi (1,000)	1.9	2.2	3.6	2.7	1.1
Flexibility	good	good	excellent	good	excellent
Cut-thru resistance	good	poor	good	fair	excellent
Water resistance	excellent	poor	excellent	excellent	good
Resistance to organic solvents	poor	poor	excellent	excellent	good
Resistance to acids and alkalis	excellent	excellent	excellent	excellent	good
Remarks	for use under 80°C maximum	for use under 80°C maximum	for high temperature use to 200°C	for high temperature use to 260°C	for pulse cables and extreme flexibility

TABLE 3 - Primary Dielectrics

Teflon® is a trademark of the DuPont de Nemours Co.

California

1959 East Cashdan Street, Rancho Dominguez, CA 90220
 (310) 609-1811 • (800) 326-0006 • FAX: (310) 609-1862
 E-Mail: salesrd@std-wire.com

Arizona

3120 West Thomas Road, Bldg. #801, Phoenix, AZ 85017
 (602) 269-2501 • (800) 325-6478 • FAX: (602) 278-7134
 E-Mail: salesphx@std-wire.com



Standard Wire & Cable Co.

PROTECTIVE COVERINGS:

Unprotected copper or aluminum tubes are utilized for the jacket both indoors and outdoors in dry locations or in aerial installations. Where there may be corrosive influences such as moist locations, electrolytic action, etc., a covering of "carbon black loaded" polyethylene or other protective covering is used.

	JACKETS					
	POLYETHYLENE	TEFLON [®] TFE	TEFLON [®] FEP	PVC	NEOPRENE [®]	GLASS BRAID
Maximum operating temperature °C	80	260	200	105	90	260
Average tensile strength psi (1,000)	1.9	3.5	2.7	2.5	3.2	-
Flexibility	good	good	good	good	excellent	excellent
Resistance to organic solvents	poor	excellent	excellent	poor	good	excellent
Resistance to acids and alkalis	excellent	excellent	excellent	fair	good	excellent
Abrasion resistance	good	excellent	excellent	good	excellent	poor
Flame resistance	slow burn	nonflammable	nonflammable	self-extinguishing	self-extinguishing	nonflammable
Remarks	for added resistance to weathering	to mate with high temperature dielectric	to mate with high temperature dielectric	most widely used	to mate with Butyl dielectric	to mate with high temperature dielectric

TABLE 4 - Jackets

The design formula for characteristic impedance of a single coaxial line is:

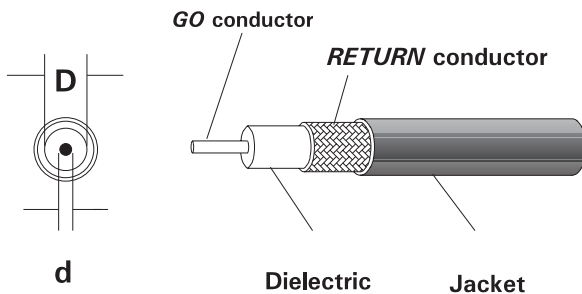

FIGURE I

$$Z_0 = (138 / \sqrt{E}) \times \log_{10} (D / d)$$

where:

Z₀ = Characteristic impedance

E = Dielectric constant (air is 1.0), see Table 5.

D = Inside diameter of the "return" (outer) conductor (conductive metal tube or one or more braids), see Figure 1.

d = Outside diameter of the "go" (inner) conductor, see Figure 1.

Dielectric Material	Dielectric Constant (E)	Power Factor (p)
Air	1.00	
Polyethylene - cellular foam (PE)	1.40 - 2.10	0.0003
Polyethylene - solid (PE)	2.3	0.0003
Teflon [®] (TFE)	2.1	0.0002
Cellular Teflon [®] (TFE)	1.4	0.0002
Teflon [®] (FEP)	2.1	0.0007
Cellular Teflon [®] (FEP)	1.5	0.0007
Butyl rubber	3.1	-
Silicone rubber	2.08 - 3.50	0.007 - 0.016

TABLE 5 - Dielectric Properties

Teflon[®] is a trademark of the DuPont de Nemours Co.
Neoprene[®] is a trademark of the DuPont de Nemours Co.

California

1959 East Cashdan Street, Rancho Dominguez, CA 90220
(310) 609-1811 • (800) 326-0006 • FAX: (310) 609-1862
E-Mail: salesrd@std-wire.com

Arizona

3120 West Thomas Road, Bldg. #801, Phoenix, AZ 85017
(602) 269-2501 • (800) 325-6478 • FAX: (602) 278-7134
E-Mail: salesphx@std-wire.com



Standard Wire & Cable Co.

Another important key to the selection of coaxial cable is the required attenuation. The formula for theoretical calculation of attenuation (A) is the attenuation due to conductors plus attenuation due to the dielectric:

$$A = 4.35 (R_t / Z_0) + 2.78 \sqrt{E} pF$$

$$= \text{dB per 100 ft.}$$

Where

R_t = Total line resistance ohms per 1000 ft.

R_t = $0.1 (1/d + 1/D) \sqrt{F}$
(for single copper line)

p = Power factor of dielectric

F = Frequency in megahertz (MHz)

As can readily be seen, attenuation would increase as the frequency increases. In a perfect cable, the pattern of increasing attenuation would be exact and regular. However, on the practical side, this is difficult to achieve and for that reason, tolerances are specified. The military RG specifications spell out in detail the tolerances permitted on various electrical characteristics. Perfect design is based first on the ability to obtain theoretically perfect cable. As with all manufacturing, this is not too practical. Therefore, the physical tolerances to which cable can be manufactured should be considered as much a part of design as the empirical formulas. These tolerances vary from cable to cable, dependent upon the physical size of the cable and the dielectric material used in its manufacture. Since the manufacture of coaxial cable is a "continuous" type manufacturing process, rather than a "batch" type, there are variations encountered. To ensure that there is no place in the cable which might cause a high attenuation, the cable can be "swept" at various frequencies, particularly those frequencies at or near the expected use of the cable.

If we examine the basic Z_0 formula, it becomes quite evident that a difference in the D of only a few thousandths of an inch would significantly affect the impedance and in the 50 ohms group of miniature cables, tolerances become even more important. Even after perfect design, there still remains the

practical installation and use to which the cable will be subjected. The power rating, as well as other characteristics, will be affected by use factors such as flexing, bending (particularly into a radius smaller than 20 times its own diameter), and variations in atmospheric pressure (high altitude).

The overall size of cable as related to the dielectric used will be strongly influenced by the important requirement of operating voltage. Power rating, which is one of the important considerations in design, is significantly influenced by the value D/d. This is the governing ratio assuming matched lines and optimum 40°C ambient temperature.

Conductor temperatures of polyethylene dielectric coaxial cable are operated between 65°C and a maximum of 80°C. To give you an idea what happens to power in relation to ambient and conductor temperature, note Figure II. To calculate a more accurate power rating, we must obviously consider both ambient and conductor temperature. Figure III shows power ratings of some preferred cables at 40°C ambient and 80°C conductor temperature. If the cable is expected to be used above 40°C ambient, we should derate accordingly. Taking RG 17 as an example, it has an approximate power rating of 930 watts at 500 MHz. If ambient is expected to be 50°C, we must derate to 75%, giving us a power rating of 700 watts.

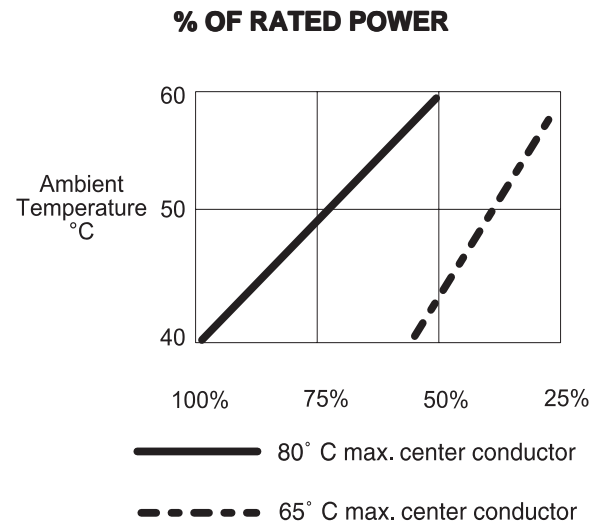

FIGURE II

California

1959 East Cashdan Street, Rancho Dominguez, CA 90220
(310) 609-1811 • (800) 326-0006 • FAX: (310) 609-1862
E-Mail: salesrd@std-wire.com

Arizona

3120 West Thomas Road, Bldg. #801, Phoenix, AZ 85017
(602) 269-2501 • (800) 325-6478 • FAX: (602) 278-7134
E-Mail: salesphx@std-wire.com



Standard Wire & Cable Co.

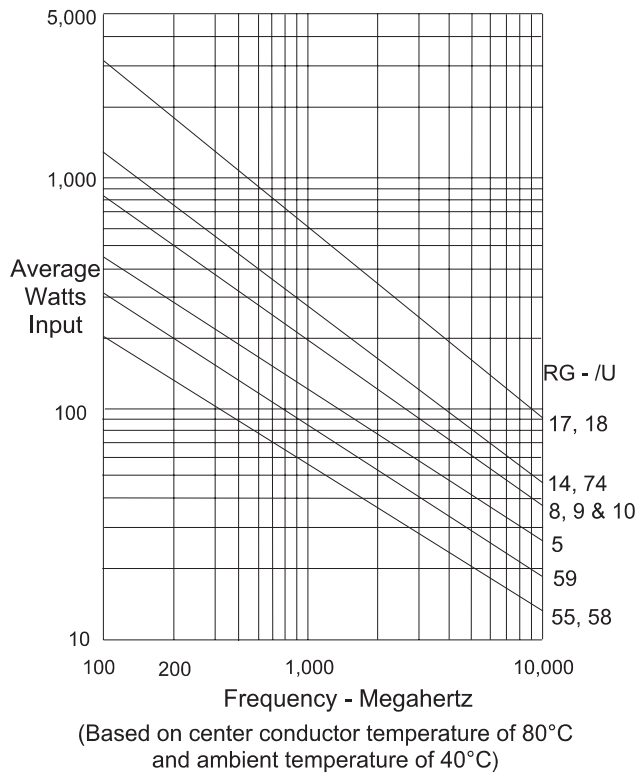

FIGURE III

Another very important consideration related not only to power but to attenuation is VSWR. VSWR is Voltage Standing Wave Ratio. This is the ratio of the voltage maximum to voltage minimum existing on a coaxial cable. It occurs when there is discontinuity or mismatch to the cable (e.g., do not use 50 ohms load for 75 ohms system). This variation from the theoretically ideal causes a reflection of the incident wave. The reflected wave and incident wave produce a standing wave. For maximum energy transfer, the importance of this relationship becomes most apparent. In many systems, a VSWR of 1.3 maximum can be tolerated but the lower the VSWR, the better becomes the finished system. Figure IV shows what happens when VSWR goes above 1.0. When VSWR increases, attenuation increases. The difficulty in obtaining a low VSWR is readily seen when one realizes the actual VSWR of any component is apt to be better than the overall VSWR measured. If we could get ideally perfectly matched connectors and also make an ideally perfect termination, we could approach the ideal VSWR (assuming ideal cabling).

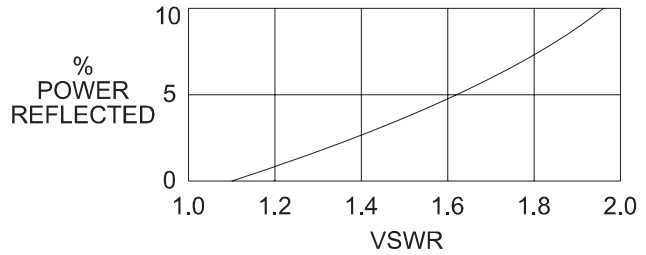

FIGURE IV

In addition to the RG types of coaxial cables, a complete list of which is shown on the pages which follow in this Technical Handbook and Catalog, there have been introduced many other types of RF transmission lines. One of the most popular commercial types is a group using foamed or cellular type dielectric. These type cables generally follow the characteristics of RG cables in the numbers 8, 11, 58, and 59. By using a unique method of manufacturing, air is introduced into the dielectric creating a dielectric very much like a sponge. This has a decided advantage over the solid dielectric in that a much better attenuation is achieved. However, the process of manufacturing is difficult to control and also there may be changes as the cable ages or is flexed, causing an increase in attenuation.

Another commercial group is the "air spaced" type. Various manufacturers market these transmission lines under various trade names. Essentially, they consist of the necessary "go" conductor around which is wound a helical vehicle to hold the "go" conductor in place. Generally the outer or "return" conductor is a solid sheath of copper or aluminum sometimes covered with polyethylene for mechanical protection and also for direct burial protection. The finished product shows a reliable, uniform, low loss cable. The popularity of these cables is gradually increasing due to their reliability and their rugged construction. They have advantages sought by the commercial users of transmission lines---the cable TV industry and also certain military system installations requiring exceptionally long life. Their advantages are: Little possibility of change in electrical characteristics due to aging; reduced maintenance costs; and uniformity resulting in good VSWR over the entire frequency range.

California

1959 East Cashdan Street, Rancho Dominguez, CA 90220
(310) 609-1811 • (800) 326-0006 • FAX: (310) 609-1862
E-Mail: salesrd@std-wire.com

Arizona

3120 West Thomas Road, Bldg. #801, Phoenix, AZ 85017
(602) 269-2501 • (800) 325-6478 • FAX: (602) 278-7134
E-Mail: salesphx@std-wire.com



MANUFACTURING

The group of RG cables known as semisolid dielectric cables, such as RG 62/U, RG 71/U, and RG 63/U, have one thing in common. They have a center conductor around which a polyethylene thread is helically wound and then over the thread, a polyethylene dielectric is extruded. In this respect all of the various groups are the same in basic design and construction up to the braid stage. We will discuss the above group since they are the more difficult to manufacture.

The "go" conductor used in the RG 62/U and RG 71/U groups is a copper-clad steel core wire, "Copperweld®". Copperweld® is made by a carefully controlled process wherein a thick copper covering is inseparably welded to a high strength steel core. In the case of RG 62/U and RG 71/U, the "go" conductor is 22 gauge with a nominal diameter of 0.0253". Since high frequency currents travel mainly in the outer skin of an electrical conductor, the Copperweld® is used in these cables to provide the unique combination of high strength along with electrical conductance.

The originality of such a design exhibits the complexity of choice involved in selecting conductors for coaxial cable. Table 1 lists some major characteristics of various conductors in popular use today. Use and application of the finished cable must not be slighted in the final design criteria.

The manufacturing process of RG 62/U or RG 71/U groups requires several operations. In the first operation, the polyethylene thread is spiraled around the conductor.

In the second operation, the dielectric is extruded over the conductor and spiraled thread. In this operation, there is a possibility of breakage of the conductor due to the fact that the spiraled thread is not always even in diameter and it may cause a jam in the extruder tip. This jam will cause a momentary stoppage and the resulting jerk may cause breakage. The extruded insulation is "spark tested" as part of the extrusion operation to make sure there are no voids or holes in the dielectric. (The inner conductor is at ground potential.) Any pinhole in the dielectric will result in a spark failure, which is recorded as

to location and reel number so that it may be cut out before passing through remaining operations.

The next operation is braiding. The extruded core is braided with one or two shields as required by the specification. During this operation, and all remaining operations, the cable is under constant tension. Following the braiding operation, the cable receives an extruded jacket. Again, the cable passes through a chain electrode at high potential to detect any jacket deficiencies. (The braid in this case is at ground potential.)

When the dielectric of polyethylene coaxial cable (whether it is solid or semisolid) is extruded, strains develop in the material. In theory, these strains are reduced by the use of hot water in the cooling trough. As the dielectric is run through the cooling trough, it runs through very hot water to cool water in graduated steps; therefore, most of the strain should have been relieved. The remaining operations all keep this first extrusion under tension, so that any strains which might have been retained from the extrusion operation have little opportunity to be relieved. When the cable is unreeled, this releases strains if any are present and there could be a conductor movement disproportionate to dielectric movement which might show up only in localized areas. To detect this possible trouble area, the "sweep test" may be used.

As is seen from the preceding explanation, there are possible problems arising in the manufacture of coaxial cable. Some physical problems may lead to electronic problems. For these reasons, manufacturers are constantly improving process controls so that the finished cable will meet the highest standards.

The manufacture of coaxial cable is an exacting process and the very sophisticated application to which it is put, demands the highest quality.

Coaxial cable is probably the most versatile type of cable in existence today. Its development was one of the truly great milestones in the science of long-distance communication as well as transmission of highly complex signals within a relatively simple cable.

Copperweld® is a trademark of Copperweld Steel Company.

California

1959 East Cashdan Street, Rancho Dominguez, CA 90220
(310) 609-1811 • (800) 326-0006 • FAX: (310) 609-1862
E-Mail: salesrd@std-wire.com

Arizona

3120 West Thomas Road, Bldg. #801, Phoenix, AZ 85017
(602) 269-2501 • (800) 325-6478 • FAX: (602) 278-7134
E-Mail: salesphx@std-wire.com



Standard Wire & Cable Co.

M17 Cable Descriptions

M17/ Number	Catalog No.	Nom. Imp. (ohms)	Cap. pF per (ft) (m)		Dielect. Mat.	Size (in.) and Type of Inner Conductor	Jacket	Shield	Overall Diameter (in) (mm)		Weight (lbs / 100ft) (kgs / 100m)		Remarks
M17/2 RG6	507-6	75	22.0	72.2	PE	0.0285 CCS	PVC-IIA	SC, BC	0.332	8.43	8.2	12	Inactive for new design See M17/180-00001
M17/6 RG11	507-11	75	22.0	72.2	PE	0.0477 7/0.0159 TC	PVC-IIA	BC	0.405	10.3	9.8	15	1,000 MHz maximum
M17/6 RG12	507-12	75	22.0	72.2	PE	0.0477 7/0.0159 TC	PVC-IIA w/armor	BC	0.475	12.1	14.4	21.4	Armored M17/6-RG11
M17/15 RG22	507-22	95	18.4	60.4	PE 2 cores	2 cond. 0.0456 7/0.0152 BC	PVC-IIA	2 TC	0.420	10.7	13.0	19.3	Balanced line, 200 MHz maximum. Inactive see M17/182-00001 unarmored
M17/15 RG111	507-111	95	18.4	60.4	PE 2 cores	2 cond. 0.0456 7/0.0152 BC	PVC-IIA w/armor	2 TC	0.490	12.4	14.6	21.7	Armored M17/15-RG22 See M17/182-00002 armored
M17/16 RG23	507-23	125	13.0	42.7	PE 2 cores	2 cond. 0.0855 7/0.0285 BC	PVC-IIA	2 indiv. inner, common outer BC	0.650 x 0.945	16.5 x 24.0	53.0	78.9	Dual coaxial balanced line, 1,000 MHz maximum CANCELED
M17/16 RG24	507-24	125	13.0	42.7	PE 2 cores	2 cond. 0.0855 7/0.0285 BC	PVC-IIA w/armor	2 indiv. inner, common outer BC	0.735 x 1.034	18.7 x 26.26	73.0	109	Armored M17/16-RG23 CANCELED
M17/19 RG25	507-25	48	50.0	164	Rubber-E	0.0585 19/0.0117 TC	Rubber-IV	2 TC	0.505	12.8	22.5	33.5	CANCELED
M17/21 RG26	507-26	48	55.0	180	Rubber-E	0.0585 19/0.0117 TC	Rubber-IV w/armor	TC	0.505	12.8	21.0	31.2	Coaxial, pulse, 1 MHz maximum CANCELED
M17/22 RG27	507-27	48	55.0	180	Rubber-D	0.0925 19/0.0185 TC	Rubber-IV w/armor	TC	0.670	17.0	33.0	49.1	Coaxial, pulse, 1 MHz maximum CANCELED
M17/22- 00001		48	55.0	180	Rubber-D	0.0925 19/0.0185 TC	Rubber-IV	TC	0.595	15.1	33.0	49.1	CANCELED
M17/23 RG28	507-28	48	50.0	164	Rubber-D	0.0925 19/0.0185 TC	Rubber-IV	TC, GS	0.735	18.7	40.0	59.5	Triaxial, pulse, 1 MHz maximum CANCELED
M17/24 RG34	507-34	75	22.0	72.2	PE	0.0747 7/0.0249 BC	PVC-IIA	BC	0.630	16.0	23.1	34.4	1,000 MHz maximum CANCELED
M17/28 RG58	507-58	50	32.2	106	PE	0.0355 19/0.0072 TC	PVC-IIA	TC	0.195	4.95	2.6	3.9	Inactive for new design See M17/183-00001
M17/29 RG59	507-59	75	22.0	72.2	PE	0.0226 CCS	PVC-IIA	BC	0.242	6.15	3.5	5.2	1,000 MHz maximum See M17/184-00001
M17/30 RG62	507-62	93	14.5	47.6	Air space PE	0.0253 CCS	PVC-IIA	BC	0.242	6.15	3.8	5.7	Inactive for new design See M17/185-00001
M17/31 RG63	507-63	125	11.0	36.1	Air space PE	0.0253 CCS	PVC-IIA	BC	0.405	10.3	8.8	13	1,000 MHz maximum
M17/31 RG79	507-79	125	11.0	36.1	Air space PE	0.0253 CCS	PVC-IIA w/armor	BC	0.475	12.1	13.8	20.5	Armored M17/31-RG63
M17/33 RG64	507-64	48	55.0	180	Rubber-E	0.0585 19/0.0117 TC	Rubber-IV	2 TC	0.460	11.7	22.0	32.7	CANCELED
M17/34 RG65	507-65	950	48.0	157	PE	0.0080 0.1280 dia. helix	PVC-IIA	BC	0.405	10.3	11.0	16.4	Coaxial, time delay, 5 MHz maximum CANCELED
M17/45 RG108	507-108	78	24.5	80.4	PE	2 cond. 0.0378 7/0.0126 TC	PVC-IIA	TC	0.235	5.97	29.0	43.2	Inactive for new design See M17/186-00001
M17/47 RG114	507-114	185	6.8	22.3	Air space PE	0.007 CCS	PVC-IIA	BC	0.405	10.3	8.9	13	1,000 MHz maximum
M17/52 RG119	507-119	50	29.3	96.1	PTFE	0.1019 BC	FG braid-V	2 BC	0.465	11.8	22.8	33.9	Swept attn. and SRL from 50 to 3,000 MHz

California

1959 East Cashdan Street, Rancho Dominguez, CA 90220
 (310) 609-1811 • (800) 326-0006 • FAX: (310) 609-1862
 E-Mail: salesrd@std-wire.com

Arizona

3120 West Thomas Road, Bldg. #801, Phoenix, AZ 85017
 (602) 269-2501 • (800) 325-6478 • FAX: (602) 278-7134
 E-Mail: salesphx@std-wire.com



Standard Wire & Cable Co.

M17/ Number	Catalog No.	Nom. Imp. (ohms)	Cap. pF per (ft) (m)		Dielect. Mat.	Size (in.) and Type of Inner Conductor	Jacket	Shield	Overall Diameter (in) (mm)		Weight (lbs / 100ft) (kgs / 100m)		Remarks
M17/52 RG120	507-120	50	29.3	96.1	PTFE	0.1019 BC	FG braid-V w/armor	2 BC	0.525	13.3	28.6	42.6	Armored M17/52-RG119
M17/54 RG122	507-122	50	30.8	101	PE	0.0308 27/0.005 TC	PVC-IIA	TC	0.160	4.06	2.0	3.0	Inactive for new design See M17/187-00001
M17/56 RG130	507-130	95	19.0	62.3	PE	2 cond. 0.0855 7/0.0285 BC	PVC-IIA	TC	0.625	15.9	30.0	44.6	200 MHz maximum CANCELED
M17/56 RG131	507-131	95	19.0	62.3	PE	2 cond. 0.0855 7/0.0285 BC	PVC-IIA w/armor	TC	0.710	18.0	40.0	59.5	Armored M17/56-RG130 CANCELED
M17/60 RG142	507-142	50	29.3	96.1	PTFE	0.0370 SCCS	FEP-IX	2 SC	0.195	4.95	4.3	6.4	Swept attn. and SRL from 50 to 8,000 MHz
M17/62 RG144	507-144	75	22.0	72.2	PTFE	0.0525 7/0.0175 SCCS	FG braid-V	SC	0.410	10.4	14.0	20.8	3,000 MHz maximum
M17/64 RG35	507-35	75	22.0	72.2	PE	0.1045 BC	PVC-IIA w/armor	BC	0.945	24.0	54.5	81.1	Armored M17/64-RG164
M17/64 RG164	507-164	75	22.0	72.2	PE	0.1045 BC	PVC-IIA	BC	0.870	22.1	50.5	75.1	1,000 MHz maximum
M17/65 RG165	507-165	50	29.3	96.1	PTFE	0.094 7/0.0315 SC	FG braid-V	SC	0.410	10.4	14.2	21.1	Swept attn. and SRL from 50 to 3,000 MHz
M17/65 RG166	507-166	50	29.3	96.1	PTFE	0.094 7/0.0315 SC	FG braid-V w/armor	SC	0.470	11.9	18.9	28.1	Armored M17/65-RG165
M17/67 RG177	507-177	50	32.2	106	PE	0.195 BC	PVC-IIA	2 SC	0.895	22.7	59.5	88.5	Swept attn. and SRL from 50 to 5,600 MHz
M17/72 RG211	507-211	50	29.3	96.1	PTFE	0.192 BC	FG braid-V	BC	0.730	18.5	51.6	76.8	Inactive for new design
M17/73 RG212	507-212	50	30.8	101	PE	0.0556 SC	PVC-IIA	2 SC	0.332	8.43	9.3	14	Inactive for new design See M17/188-00001
M17/74 RG213	507-213	50	30.8	101	PE	0.0888 7/0.0296 BC	PVC-IIA	BC	0.405	10.3	12.0	17.9	Inactive for new design See M17/189-00001
M17/74 RG215	507-215	50	30.8	101	PE	0.0888 7/0.0296 BC	PVC-IIA w/armor	BC	0.475	12.1	16.0	23.8	Inactive for new design See M17/189-00002
M17/75 RG214	507-214	50	32.2	106	PE	0.0888 7/0.0296 SC	PVC-IIA	2 SC	0.425	10.8	13.0	19.3	Swept attn. and SRL from 50 to 11,000 MHz
M17/75 RG365	507-365	50	32.2	106	PE	0.0888 7/0.0296 SC	TPE	2 SC	0.425	10.8	13.0	19.3	M17/75-RG214 with extended low temp. range
M17/77 RG216	507-216	75	22.0	72.2	PE	0.0477 7/0.0159 TC	PVC-IIA	2 BC	0.425	10.8	12.4	18.5	Inactive for new design See M17/191-00001
M17/78 RG217	507-217	50	32.2	106	PE	0.106 BC	PVC-IIA	2 BC	0.545	13.8	22.5	33.5	Swept attn. and SRL from 50 to 3,000 MHz
M17/78 - 00001	507-217	50	32.2	106	PE	0.106 BC	PVC-IIA	2 BC	0.545	13.8	22.5	33.5	Temperature stabilized
M17/79 RG218	507-218	50	32.2	106	PE	0.195 BC	PVC-IIA	BC	0.870	22.1	57.5	85.6	Inactive for new design See M17/193-00001
M17/79 RG219	507-219	50	32.2	106	PE	0.195 BC	PVC-IIA w/armor	BC	0.945	24.0	63.5	94.5	Inactive for new design See M17/193-00002
M17/81- 00001		50	31.4	103	PE	0.260 BC	PVC-IIA	BC	1.120	28.4	58.5	87.0	1,000 MHz maximum
M17/81- 00002		50	31.4	103	PE	0.260 BC	PVC-IIA w/armor	BC	1.195	30.4	58.5	87.0	Armored M17/81-00001
M17/84 RG223	507-223	50	30.8	101	PE	0.035 SC	PVC-IIA	2 SC	0.212	5.38	3.6	5.4	Inactive for new design See M17/194-00001
M17/86- 00001		50	32.4	106	PTFE	0.0936 SC 7/0.0312	FG braid-V	2 SC	0.430	10.9	19.5	29.0	Supersedes RG-225/U
M17/86- 00002		50	32.4	106	PTFE	0.0936 SC 7/0.0312	FG braid-V w/armor	2 SC	0.490 max.	12.4 max.	19.5	29.0	Armored M17/86-00001
M17/87- 00001		50	31.7	104	Taped PTFE	0.117 SC 19/0.0234	FG braid-V	2 BC	0.500	12.7	44.8	66.7	Supersedes RG-226/U

California

1959 East Cashdan Street, Rancho Dominguez, CA 90220
 (310) 609-1811 • (800) 326-0006 • FAX: (310) 609-1862
 E-Mail: salesrd@std-wire.com

Arizona

3120 West Thomas Road, Bldg. #801, Phoenix, AZ 85017
 (602) 269-2501 • (800) 325-6478 • FAX: (602) 278-7134
 E-Mail: salesphx@std-wire.com



Standard Wire & Cable Co.

M17/ Number	Catalog No.	Nom. Imp. (ohms)	Cap. pF per		Dielect. Mat.	Size (in.) and Type of Inner Conductor	Jacket	Shield	Overall Diameter		Weight		Remarks
			(ft)	(m)					(in)	(mm)	(lbs / 100ft)	(kgs / 100m)	
M17/90 RG71	507-71	93	14.5	47.6	Air space PE	0.0253 CCS	PE-III A	2 TC	0.245	6.22	5.0	7.4	1,000 MHz maximum
M17/92 RG115	507-115	50	32.0	105	Taped PTFE	0.0840 7/0.0280 SC	FG braid-V	2 SC	0.415	10.5	18.5	27.5	Inactive for new design
M17/92- 00001		50	32.0	105	Taped PTFE	0.0840 7/0.0280 SC	FEP-IX	2 SC	0.344	8.74	18.5	27.5	Inactive for new design
M17/93 RG178	507-178	50	32.0	105	PTFE	0.0120 7/0.0040 SCCS	FEP-IX	SC	0.071	1.80	0.625	0.930	Swept attn. and SRL from 50 to 3,000 MHz
M17/93- 00001		50	32.0	105	PTFE	0.0120 7/0.0040 SCCS	PFA-XIII	SC	0.071	1.80	0.625	0.930	M17/93-RG178 with extended high temp. range
M17/94 RG179	507-179	75	23.0	75.5	PTFE	0.0120 7/0.0040 SCCS	FEP-IX	SC	0.100	2.54	1.08	1.61	3,000 MHz maximum
M17/95 RG180	507-180	95	15.4	50.5	PTFE	0.0120 7/0.0040 SCCS	FEP-IX	SC	0.141	3.58	1.98	2.95	3,000 MHz maximum
M17/96 RG209	507-209	50	26.5	86.9	Taped PTFE	0.190 19/0.0378 SC	FG-SR	2 SC	0.700	17.8	43.2	64.3	CANCELED
M17/97 RG210	507-210	93	14.5	47.6	Air space PTFE	0.0253 SCCS	FG braid-V	SC	0.242	6.15	5.0	7.4	3,000 MHz maximum
M17/100 RG133	507-133	95	16.2	53.2	PE	0.0253 BC	PVC-II A	BC	0.405	10.3	9.5	14	CANCELED
M17/109 RG301	507-301	50	32.0	105	PTFE	0.0609 7/0.0203 HR	FEP-IX	NC resistance	0.245	6.22	6.8	10	Inactive for new design
M17/110 RG302	507-302	75	22.0	72.2	PTFE	0.0253 SCCS	FEP-IX	SC	0.202	5.13	4.0	6.0	3,000 MHz maximum
M17/111 RG303	507-303	50	29.3	96.1	PTFE	0.037 SCCS	FEP-IX	SC	0.170	4.32	3.1	4.6	Swept attn. and SRL from 50 to 3,000 MHz
M17/112 RG304	507-304	50	32.0	105	PTFE	0.0590 SCCS	FEP-IX	2 SC	0.280	7.11	4.5	6.7	Swept attn. and SRL from 50 to 8,000 MHz
M17/113 RG316	507-316	50	32.0	105	PTFE	0.0201 7/0.0067 SCCS	FEP-IX	SC	0.098	2.49	1.22	1.82	Swept attn. and SRL from 50 to 3,000 MHz
M17/116 RG307	507-307	75	19.7	64.6	PE foam	0.0290 19/0.0058 SC	PE-III A	2 SC interlayer	0.265	6.73	8.0	12	Triaxial 1,000 MHz maximum
M17/119 RG174	507-174	50	32.2	106	PE	0.0189 7/0.0063 CCS	PVC-II A	TC	0.110	2.79	0.95	1.4	Inactive for new design See M17/196-00001
M17/124 RG328	507-328	25	85.0	279	Rubber	0.485 TC braid	Neoprene®	TC, GS, TC interlayer	1.460	37.08	160.0	238.1	CANCELED
M17/125 RG329	507-329	50	50.0	164	Rubber	0.0585 19/0.0117 TC	Neoprene®	TC, GS, TC interlayer	0.700	17.8	38.0	56.5	1,000 MHz maximum
M17/126 RG391	507-391	72	23.0	75.5	PE	0.0477 7/0.0159 TC	PVC-II A	TC	0.405	10.3	10.0	14.9	1,000 MHz maximum
M17/126 RG392	507-392	72	23.0	75.5	PE	0.0477 7/0.0159 TC	PVC-II A w/armor	TC	0.475	12.1	12.5	18.6	Armored M17/126-RG391
M17/127 RG393	507-393	50	32.0	105.0	PTFE	0.094 7/0.0312 SC	FEP-IX	2 SC	0.390	9.91	17.5	26.0	Swept attn. and SRL from 50 to 11,000 MHz
M17/128 RG400	507-400	50	32.0	105.0	PTFE	0.0384 19/0.008 SC	FEP-IX	2 SC	0.195	4.95	5.0	7.4	Swept attn. and SRL from 50 to 12,400 MHz
M17/129 RG401	507-401	50	29.6	97.1	PTFE	0.0641 SC	None	BC tube	0.250	6.35	10.5	15.6	Swept attn. and SRL from 400 to 18,000 MHz
M17/129- 00001		50	29.6	97.1	PTFE	0.0641 SC	None	TC tube	0.250	6.35	10.6	15.8	Tin-plated M17/129-RG401
M17/130 RG402	507-402	50	29.9	98.1	PTFE	0.0362 SCCS	None	BC tube	0.141	3.58	3.44	5.12	Swept attn. and SRL from 500 to 20,000 MHz
M17/130- 00001		50	29.9	98.1	PTFE	0.0362 SCCS	None	TC tube	0.141	3.58	3.51	5.22	Tin-plated M17/130-RG402

California

1959 East Cashdan Street, Rancho Dominguez, CA 90220
(310) 609-1811 • (800) 326-0006 • FAX: (310) 609-1862

E-Mail: salesrd@std-wire.com

Arizona

3120 West Thomas Road, Bldg. #801, Phoenix, AZ 85017
(602) 269-2501 • (800) 325-6478 • FAX: (602) 278-7134

E-Mail: salesphx@std-wire.com



Standard Wire & Cable Co.

M17/ Number	Catalog No.	Nom. Imp. (ohms)	Cap. pF per (ft) (m)		Dielect. Mat.	Size (in.) and Type of Inner Conductor	Jacket	Shield	Overall Diameter (in) (mm)		Weight (lbs / 100ft) (kgs / 100m)		Remarks
M17/130-00002		50	29.9	98.1	PTFE	0.0362 NCCCS	None	BC tube	0.141	3.58	3.44	5.12	Swept attn. and SRL from 500 to 20,000 MHz
M17/130-00003		50	29.9	98.1	PTFE	0.0362 NCCCS	None	TC tube	0.141	3.58	3.51	5.22	Tin-plated M17/130-00002
M17/130-00004		50	29.9	98.1	PTFE	0.0362 SCCS	None	BC tube	0.141	3.58	3.44	5.12	Swept attn. and SRL from 500 to 20,000 MHz
M17/130-00005		50	29.9	98.1	PTFE	0.0362 SCCS	None	TC tube	0.141	3.58	3.51	5.22	Tin-plated M17/130-00004
M17/130-00006		50	29.9	98.1	PTFE	0.0362 NCCCS	None	BC tube	0.141	3.58	3.44	5.12	Swept attn. and SRL from 500 to 20,000 MHz
M17/130-00007		50	29.9	98.1	PTFE	0.0362 NCCCS	None	TC tube	0.141	3.58	3.51	5.22	Tin-plated M17/130-00006
M17/130-00008		50	29.4	96.5	PTFE	0.0362 SCCS	None	AL tube	0.141	3.58	1.88	2.80	
M17/130-00009		50	29.4	96.5	PTFE	0.0362 SCCS	None	AL tube	0.141	3.58	2.05	3.05	Tin-plated M17/130-00008
M17/130-00010		50	29.4	96.5	PTFE	0.0362 NCCCS	None	AL tube	0.141	3.58	1.88	2.80	
M17/130-00011		50	29.4	96.5	PTFE	0.0362 NCCCS	None	AL tube	0.141	3.58	2.05	3.05	Tin-plated M17/130-00010
M17/131 RG403	507-403	50	30.2	99.1	PTFE	0.012 SCCS 7/0.004	FEP-IX	2 SC FEP interlayer	0.104	2.64	1.65	2.46	Triaxial, swept attn. and SRL from 50 to 10,000 MHz
M17/132 RG404	507-404	50	31.5	103	PTFE	0.012 SCCS 7/0.004	FEP-IX	SC	0.071	1.80	1.65	2.46	Superseded by M17/132-00001
M17/132-00001		50	32.0	105	PTFE	0.012 SCCS 7/0.004	FEP-IX	SC	0.073	1.85	1.65	2.46	1,000 MHz maximum
M17/133 RG405	507-405	50	32.0	105	PTFE	0.0201 SCCS	None	BC tube	0.0865	2.20	1.53	2.28	Swept attn. and SRL from 500 to 20,000 MHz
M17/133-00001		50	32.0	105	PTFE	0.0201 SCCS	None	TC tube	0.0865	2.197	1.58	2.35	Tin-plated M17/133-RG405
M17/133-00002		50	32.0	105	PTFE	0.0201 SC	None	BC tube	0.0865	2.197	1.52	2.26	Swept attn. and SRL from 500 to 20,000 MHz
M17/133-00003		50	32.0	105	PTFE	0.0201 SC	None	TC tube	0.0865	2.197	1.57	2.34	Tin-plated M17/133-00002
M17/133-00004		50	32.0	105	PTFE	0.0201 NCCCS	None	BC tube	0.0860	2.184	1.54	2.29	Swept attn. and SRL from 500 to 20,000 MHz
M17/133-00005		50	32.0	105	PTFE	0.0201 NCCCS	None	TC tube	0.0860	2.184	1.59	2.37	Tin-plated M17/133-00004
M17/133-00006		50	32.0	105	PTFE	0.0201 SCCS	None	BC tube	0.0865	2.197	1.53	2.28	Swept attn. and SRL from 500 to 20,000 MHz
M17/133-00007		50	32.0	105	PTFE	0.0201 SCCS	None	TC tube	0.0865	2.197	1.58	2.35	Tin-plated M17/133-00006
M17/133-00008		50	32.0	105	PTFE	0.0201 SC	None	BC tube	0.0865	2.197	1.52	2.26	Swept attn. and SRL from 500 to 20,000 MHz
M17/133-00009		50	32.0	105	PTFE	0.0201 SC	None	TC tube	0.0865	2.197	1.57	2.34	Tin-plated M17/133-00008
M17/133-00010		50	32.0	105	PTFE	0.0201 NCCCS	None	BC tube	0.0860	2.184	1.54	2.29	Swept attn. and SRL from 500 to 20,000 MHz
M17/133-00011		50	32.0	105	PTFE	0.0201 NCCCS	None	TC tube	0.0865	2.197	1.59	2.37	Tin-plated M17/133-00010
M17/133-00012		50	32.0	105	PTFE	0.0201 SCCS	None	BC tube	0.0865	2.197	0.75	1.1	
M17/133-00013		50	32.0	105	PTFE	0.0201 SCCS	None	TC tube	0.0865	2.197	0.8	1	Tin-plated M17/135-00012
M17/133-00014		50	32.0	105	PTFE	0.0201 NCCCS	None	BC tube	0.0865	2.197	0.75	1.1	
M17/133-00015		50	32.0	105	PTFE	0.0201 NCCCS	None	TC tube	0.0865	2.197	0.8	1	Tin-plated M17/133-00014
M17/133-00016		50	32.0	105	PTFE	0.0201 SCCS	None	SPC tube	0.0865	2.197	1.58	2.35	

California

1959 East Cashdan Street, Rancho Dominguez, CA 90220
 (310) 609-1811 • (800) 326-0006 • FAX: (310) 609-1862
 E-Mail: salesrd@std-wire.com

Arizona

3120 West Thomas Road, Bldg. #801, Phoenix, AZ 85017
 (602) 269-2501 • (800) 325-6478 • FAX: (602) 278-7134
 E-Mail: salesphx@std-wire.com



Standard Wire & Cable Co.

M17/ Number	Catalog No.	Nom. Imp. (ohms)	Cap. pF per		Dielect. Mat.	Size (in.) and Type of Inner Conductor	Jacket	Shield	Overall Diameter		Weight (lbs / 100ft / 100m)		Remarks
			(ft)	(m)					(in)	(mm)	(lbs / 100ft)	(kgs / 100m)	
M17/133-00017		50	32.0	105	PTFE	0.0201 NCCCS	None	SPC tube	0.086	2.197	1.58	2.35	
M17/134-00001		50	32.2	106	PE	0.033 SC	PE-III-A	2 SC PE interlayer	0.245	6.22	4.5	6.7	Water blocked triaxial, swept attn. and SRL from 50 to 3,000 MHz
M17/134-00002		50	32.2	106	PE	0.033 SC	PE-III-A	2 SC PE interlayer	0.245	6.22	4.5	6.7	Non-water blocked M17/134-00001
M17/134-00003		50	32.2	106	PE	0.033 SC	XL polyolefin	2 SC PE interlayer	0.245	6.22	5.0	7.4	Water blocked
M17/134-00004		50	32.2	106	PE	0.033 SC	XL polyolefin	2 SC PE interlayer	0.245	6.22	5.0	7.4	Non-water blocked M17/134-00003
M17/135-00001		50	32.0	105	PE	0.089 SC 7/0.0296	PU	2 SC PE interlayer	0.500	12.7	16.0	23.8	Water blocked triaxial, swept attn. and SRL from 50 to 3,000 MHz
M17/135-00002		50	32.0	105	PE	0.089 SC 7/0.0296	PU	2 SC PE interlayer	0.500	12.7	16.0	23.8	Non-water blocked M17/134-00001
M17/135-00003		50	32.0	105	PE	0.081 SC	PE	2 SC PE interlayer	0.500	12.7	18.5	27.5	Water blocked
M17/135-00004		50	32.0	105	PE	0.081 SC	PE	2 SC PE interlayer	0.500	12.7	18.5	27.5	Non-water blocked M17/135-00003
M17/135-00005		50	32.0	105	PE	0.081 SC	XL polyolefin	2 SC PE interlayer	0.500	12.7	18.5	27.5	Water blocked
M17/135-00006		50	32.0	105	PE	0.081 SC	XL polyolefin	2 SC PE interlayer	0.500	12.7	18.5	27.5	Non-water blocked M17/135-00005
M17/136-00001		75	22.0	72.2	PTFE	0.012 SCCS 7/0.004	PFA-XIII	SC	0.100	2.54	1.2	1.8	
M17/137-00001		95	15.4	50.5	PTFE	0.012 SCCS 7/0.004	PFA-XIII	SC	0.141	3.58	2.0	3.0	
M17/138-00001		50	32.0	105	PTFE	0.0201 SCCS 7/0.0067	PFA-XIII	SC	0.098	2.49	1.22	1.82	Swept attn. and SRL from 50 to 3,000 MHz
M17/139-00001		95	15.4	50.5	PTFE	0.012 SCBerC 7/0.004	PFA-XIII	SC Cad Br	0.141	3.58	178	265	Use up to 3,000 MHz maximum
M17/140-00001		50	29.3	96.1	PTFE	0.012 SCCS 7/0.004	PFA-XIII	SC	0.071	1.80	0.625	0.930	CANCELED Use M17/93
M17/151-00001		50	32.0	105	PTFE	0.0113 SCCS	None	BC tube	0.047	1.19	4.5	6.7	Swept attn. and SRL from 500 to 20,000 MHz
M17/151-00002		50	32.0	105	PTFE	0.0113 SCCS	None	TC tube	0.047	1.19	4.8	7.1	Tin-plated M17/151-00001
M17/152-00001		50	32.0	105	PTFE	0.0201 SCCS 7/0.0067	FEP-IX	2 SC	0.114	2.90	1.85	2.75	Swept attn. and SRL from 500 to 12,400 MHz
M17/153-00001		50	32.2	106	PE	0.0189 CCS 7/0.0063	PVC-II-A	2 SC	0.114	2.90	3.0	4.5	CANCELED Use M17/152-00001
M17/154-00001		50	32.0	105	PTFE	0.008 SCCS	None	BC Tube	0.034	0.86	0.26	0.39	
M17/154-00002		50	32.0	105	PTFE	0.008 SCCS	None	TC Tube	0.034	0.86	0.28	0.42	Tin-plated M17/154-00001
M17/155-00001		50	30.8	101	PE	0.0355 TC 19/0.0072	PVC-II-A	TC	0.195	4.95	3.1	4.6	Inactive for new design Use M17/197-00001
M17/156-00001		50	29.3	96.1	PTFE	0.1019 BC	2 FG Braid-V	2 BC	0.465	11.81	24.0	35.7	
M17/157-00001		50	30.8	101	PE	0.0308 TC 27/0.005	PVC-II-A	TC	0.160	4.06	2.4	3.6	Inactive for new design Use M17/198-00001
M17/158-00001		50	29.3	96.1	PTFE	0.037 SCCS	FEP-IX	2 SC	0.195	4.95	5.6	8.3	Unswep M17/60-RG142. Use below 400 MHz
M17/159-00001		50	29.3	96.1	PTFE	0.094 SC 7/0.0315	2 FG Braid-V	SC	0.410	10.4	21.8	32.4	Unswep M17/65-RG165. Use below 400 MHz
M17/160-00001		50	32.2	106	PE	0.195 BC	PVC-II-A	2 SC	0.895	22.7	59.5	88.5	Unswep M17/67-RG177. Use below 400 MHz

California

1959 East Cashdan Street, Rancho Dominguez, CA 90220
 (310) 609-1811 • (800) 326-0006 • FAX: (310) 609-1862
 E-Mail: salesrd@std-wire.com

Arizona

3120 West Thomas Road, Bldg. #801, Phoenix, AZ 85017
 (602) 269-2501 • (800) 325-6478 • FAX: (602) 278-7134
 E-Mail: salesphx@std-wire.com



Standard Wire & Cable Co.

M17/ Number	Catalog No.	Nom. Imp. (ohms)	Cap. pF per (ft) (m)		Dielect. Mat.	Size (in.) and Type of Inner Conductor	Jacket	Shield	Overall Diameter (in) (mm)		Weight (lbs / 100ft) (kgs / 100m)		Remarks
M17/161-00001		50	29.3	96.1	PTFE	0.192 BC	2 FG braid-V	BC	0.730	18.5	65.0	96.7	Inactive for new design
M17/161-00002		50	29.3	96.1	PTFE	0.192 BC	2 FG braid-V w/armor	BC	0.795	20.2	65.0	96.7	Inactive for new design
M17/162-00001		50	32.2	106	PE	0.0556 SC	PVC-IIA	2 SC	0.332	8.43	8.9	13	Inactive for new design Use M17/199-00001
M17/163-00001		50	30.8	101	PE	0.0888 BC 7/0.0296	PVC-IIA	BC	0.405	10.3	12.5	18.6	Unswpt M17/74-RG213. Use below 400 MHz
M17/164-00001		50	32.2	106	PE	0.0888 SC 7/0.0296	PVC-IIA	2 SC	0.425	10.8	14.0	20.8	Unswpt M17/75-RG214. Use below 400 MHz
M17/164-00002		50	32.2	106	PE	0.0888 SC 7/0.0296	TPE	2 SC	0.425	10.8	14.0	20.8	Unswpt M17/75-RG365. Use below 400 MHz
M17/165-00001		50	30.8	101	PE	0.106 BC	PVC-IIA	2 BC	0.545	13.8	26.5	39.4	Unswpt M17/78-RG217. Use below 400 MHz
M17/165-00002		50	30.8	101	PE	0.106 BC	PVC-IIA w/armor	2 BC	0.615	15.6	26.5	39.4	Inactive for new design
M17/166-00001		50	32.2	106	PE	0.195 BC	PVC-IIA	BC	0.870	22.1	57.5	85.6	Unswpt M17/79-RG218. Use below 400 MHz
M17/167-00001		50	32.2	106	PE	0.035 SC	PVC-IIA	2 SC	0.212	5.38	4.1	6.1	Inactive for new design Use M17/200-00001
M17/168-00001		50	32.0	105	Taped PTFE	0.084 SC 7/0.028	3 FG braid-V	2 SC	0.415	10.5	18.5	27.5	Unswpt M17/92-RG115. Use below 400 MHz
M17/168-00002		50	32.0	105	Taped PTFE	0.084 SC 7/0.028	FEP-IX	2 SC	0.344	8.74	18.5	27.5	FEP jacketed M17/92-RG115
M17/169-00001		50	32.0	105	PTFE	0.012 SCCS 7/0.004	FEP-IX	SC	0.071	1.80	0.63	0.94	Unswpt M17/93-RG178. Use below 400 MHz
M17/170-00001		50	29.3	96.1	PTFE	0.037 SCCS	FEP-IX	SC	0.170	4.32	3.9	5.8	Unswpt M17/111-RG303. Use below 400 MHz
M17/171-00001		50	32.0	105	PTFE	0.059 SCCS	FEP-IX	2 SC	0.280	7.11	9.24	13.7	
M17/172-00001		50	32.0	105	PTFE	0.0201 SCCS 7/0.0067	FEP-IX	SC	0.098	2.49	1.15	1.71	Unswpt M17/113-RG316. Use below 400 MHz
M17/173-00001		50	30.8	101	PE	0.0189 CCS 7/0.0063	PVC-IIA	TC	0.110	2.79	0.95	1.4	Unswpt M17/119-RG174. Use below 400 MHz
M17/174-00001		50	32.0	105	PTFE	0.094 SC 7/0.0312	FEP-IX	2 SC	0.390	9.91	17.5	26.0	Unswpt M17/127-RG393. Use below 400 MHz
M17/175-00001		50	32.0	105	PTFE	0.0384 SC 19/0.008	FEP-IX	2 SC	0.195	4.95	5.0	7.4	Unswpt M17/128-RG400. Use below 400 MHz
M17/176-00002		77	24.0	78.7	2 PTFE	2 cond. 0.023 19/0.005 SCHSCA	PFA-XIII	SCHSCA	0.129	3.28	1.8	2.7	Use up to 10 MHz maximum
M17/176-00003		77	24.0	78.7	2 ECTE or ETFE foam	2 cond. 0.023 19/0.005 SCHSCA	PFA, FEP, ETFE, or ECTFE	SCHSCA	0.125	3.18	1.6	2.4	Use up to 10 MHz maximum
M17/177-00001		95	17.4	57.1	PTFE	0.012 SCCS 7/0.004	2 FEP-IX	2 SC	0.184	4.67	3.4	5.1	Use up to 3,000 MHz maximum
M17/178-00001		95	17.4	57.1	PTFE	0.012 SCCS 7/0.004	Inner FEP-IX, outer polyester braid	SC, NC, CPC Tape, NC	0.270	6.86	6.0	8.9	

California

1959 East Cashdan Street, Rancho Dominguez, CA 90220
 (310) 609-1811 • (800) 326-0006 • FAX: (310) 609-1862
 E-Mail: salesrd@std-wire.com

Arizona

3120 West Thomas Road, Bldg. #801, Phoenix, AZ 85017
 (602) 269-2501 • (800) 325-6478 • FAX: (602) 278-7134
 E-Mail: salesphx@std-wire.com



Standard Wire & Cable Co.

M17/ Number	Catalog No.	Nom. Imp. (ohms)	Cap. pF per (ft) (m)		Dielect. Mat.	Size (in.) and Type of Inner Conductor	Jacket	Shield	Overall Diameter (in) (mm)		Weight (lbs / 100ft) (kgs / 100m)		Remarks
M17/179-00001		75	23.0	75.5	PTFE	0.012 SCCS 7/0.004	Inner FEP-IX, outer polyester braid	SC, NC, CPC tape, NC	0.195	4.95	3.65	5.43	Use up to 3,000 MHz maximum
M17/180-00001		75	22.0	72.2	PE	0.0285 CCS	XL polyolefin	1 SC 1 BC AL/MY	0.332	8.43	9.2	14	Non-Halogen, low smoke M17/2-RG6
M17/181-00001		75	22.0	72.2	PE	0.0477 7/0.0159 TC	XL polyolefin	BC AL/MY	0.405	10.3	10.8	16.1	Non-Halogen, low smoke M17/6-RG11
M17/181-00002		75	22.0	72.2	PE	0.0477 7/0.0159 TC	XL polyolefin w/armor	BC AL/MY	0.475 max.	12.1 max.	13.2	19.6	Non-Halogen, low smoke M17/6-RG12
M17/182-00001		95	17.4	57.1	PE	2 cond. 0.0456 7/0.0152 BC	XL polyolefin	2 TC AL/MY	0.420	10.7	14.2	21.1	Non-Halogen, low smoke M17/15-RG22
M17/182-00002		95	17.4	57.1	PE	2 cond. 0.0456 7/0.0152 BC	XL polyolefin w/armor	2 TC AL/MY	0.490 max.	12.4 max.	16.9	25.1	Non-Halogen, low smoke M17/15-RG111
M17/183-00001		50	32.2	106	PE	0.0355 19/0.0072 TC	XL polyolefin	TC AL/MY	0.195	4.95	3.0	4.5	Non-Halogen, low smoke M17/28-RG58
M17/184-00001		75	22.0	72.2	PE	0.0226 CCS	XL polyolefin	BC AL/MY	0.242	6.15	4.3	6.4	Non-Halogen, low smoke M17/29-RG59
M17/185-00001		93	14.5	47.6	Air space PE	0.0253 CCS	XL polyolefin	BC AL/MY	0.242	6.15	4.2	6.2	Non-Halogen, low smoke M17/2-RG6
M17/186-00001		78	24.5	80.4	2 PE	2 cond. 0.0378 7/0.0126 TC	XL polyolefin	TC AL/MY	0.235	5.97	4.1	6.1	Non-Halogen, low smoke M17/45-RG108
M17/187-00001		50	32.2	106	PE	0.0308 27/0.005 TC	XL polyolefin	TC AL/MY	0.160	4.06	2.3	3.4	Non-Halogen, low smoke M17/54-RG122
M17/188-00001		50	32.2	106	PE	0.0556 SC	XL polyolefin	2 SC AL/MY	0.332	8.43	9.9	15	Non-Halogen, low smoke M17/73-RG212
M17/189-00001		50	32.2	106	PE	0.0888 7/0.0296 BC	XL polyolefin	BC AL/MY	0.405	10.3	12.1	18.0	Non-Halogen, low smoke M17/74-RG213
M17/189-00002		50	32.2	106	PE	0.0888 7/0.0296 BC	XL polyolefin w/armor	BC AL/MY	0.475	12.1	14.6	21.7	Non-Halogen, low smoke M17/74-RG215
M17/190-00001		50	32.2	106	PE	0.0888 7/0.0296 SC	XL polyolefin	2 SC AL/MY	0.425	10.8	15.4	22.9	Non-Halogen, low smoke M17/75-RG214
M17/191-00001		75	22.0	72.2	PE	0.0477 7/0.0159 TC	XL polyolefin	2 BC AL/MY	0.425	10.8	13.9	20.7	Non-Halogen, low smoke M17/77-RG216
M17/192-00001		50	32.2	106	PE	0.106 BC	XL polyolefin	2 BC AL/MY	0.545	13.8	24.8	36.9	Non-Halogen, low smoke M17/78-RG217
M17/192-00002		50	32.2	106	PE	0.106 BC	XL polyolefin	2 BC AL/MY	0.545	13.8	24.8	36.9	Temperature stabilization -280°C to + 65°C
M17/193-00001		50	32.2	106	PE	0.195 BC	XL polyolefin	BC AL/MY	0.870	22.1	52.1	77.5	Non-Halogen, low smoke M17/79-RG218
M17/193-00002		50	32.2	106	PE	0.195 BC	XL polyolefin w/armor	BC AL/MY	0.945	24.0	57.1	85.0	Non-Halogen, low smoke M17/79-RG219
M17/194-00001		50	32.2	106	PE	0.035 SC	XL polyolefin	2 SC AL/MY	0.212	5.38	4	6	Non-Halogen, low smoke M17/84-RG223
M17/195-00001		93	14.5	47.6	Air space PE	0.0253 CCS	XL polyolefin	BC, TC AL/MY	0.245	6.22	5.3	7.9	Non-Halogen, low smoke M17/90-RG71
M17/196-00001		50	32.2	106	PE	0.0189 7/0.0063 CCS	XL polyolefin	TC AL/MY	0.110	2.79	0.88	1.3	Non-Halogen, low smoke M17/119-RG174
M17/197-00001		50	32.2	106	PE	0.0355 19/0.0072 TC	XL polyolefin	TC AL/MY	0.195	4.95	3.1	4.6	Non-Halogen, low smoke M17/155-00001
M17/198-00001		50	32.2	106	PE	0.308 27/0.005 TC	XL polyolefin	TC AL/MY	0.160	4.06	2.4	3.6	Non-Halogen, low smoke M17/157-00001
M17/199-00001		50	32.2	106	PE	0.0556 SC	XL polyolefin	2 SC AL/MY	0.332	8.43	10	15	Non-Halogen, low smoke M17/162-00001
M17/200-00001		50	32.2	106	PE	0.035 SC	XL polyolefin	2 SC AL/MY	0.212	5.38	4.4	6.5	Non-Halogen, low smoke M17/167-00001

California

1959 East Cashdan Street, Rancho Dominguez, CA 90220
(310) 609-1811 • (800) 326-0006 • FAX: (310) 609-1862

E-Mail: salesrd@std-wire.com

Arizona

3120 West Thomas Road, Bldg. #801, Phoenix, AZ 85017
(602) 269-2501 • (800) 325-6478 • FAX: (602) 278-7134

E-Mail: salesphx@std-wire.com



Standard Wire & Cable Co.

M17 Number	Catalog No.	Nom. Imp. (ohms)	Cap. pF per (ft) (m)		Dielect. Mat.	Size (in.) and Type of Inner Conductor	Jacket	Shield	Overall Diameter (in) (mm)		Weight (lbs / (100ft) (kgs / 100m))		Remarks
M17/201-00001		77	30.0	98.4	XL modified ETFE	2-19/0.0050 SCHSCA	XL modified ETFE	TC	0.137	3.48	1.4	2.1	Twinaxial data bus
M17/201-00002		77	30.0	98.4	XL modified ETFE	2-19/0.0063 TC	XL modified ETFE	TC	0.165	4.19	2.2	3.3	Twinaxial data bus
M17/201-00003		77	30.0	98.4	XL modified ETFE	2-19/0.0050 SCHSCA	XL modified ETFE	TC	0.130	3.30	1.59	2.37	Twinaxial data bus
M17/202-00001		77	30.0	98.4	XL modified ETFE	2-19/0.0050 SCHSCA	XL modified ETFE	2 TC	0.147	3.73	2.6	3.9	Dual shield data bus
M17/203-00001		77	30.0	98.4	XL modified ETFE	0.025 2-19/0.0050 SCHSCA	XL modified ETFE	2 TC Mumetal tape	0.161	4.09	2.9	4.3	Dual shield EMP hardened data bus
M17/205-00018		50	27.0	88.6	Expanded PTFE tape	0.0298 SC	PFA- XIII	2 SC	0.120	3.05	1.5	2.2	Low loss, high temperature applications, test free 50 MHz to 18 GHz
M17/205-00050		50	27.0	88.6	Expanded PTFE tape	0.0298 SC	PFA- XIII	2 SC	0.120	3.05	1.5	2.2	Test Free 50 MHz to 50 GHz
M17/206-00018		50	32.0	105	PTFE	0.0365 SC	FEP- IX	2 SC interlayer	0.169	4.29	4.00	5.95	Test Free 50 MHz to 18 GHz
M17/206-00030		50	32.0	105	PTFE	0.0365 SC	FEP- IX	2 SC interlayer	0.169	4.29	4.00	5.95	Test Free 50 MHz to 30 GHz
M17/208-00001		185	7.2	24	Air space PE	0.007 CCS	XL polyolefin	BC AL/MY	0.405	10.3	8.90	13.2	
M17/209-00001		75	22.0	72.2	PE	0.1045 BC	XL polyolefin	BC AL/MY	0.870	22.1	50.50	75.14	Use in new designs of M17/67
M17/209-00002		75	22.0	72.2	PE	0.1045 BC	XL polyolefin w/armor	BC AL/MY	0.945	24.0	54.50	81.10	Armored M17/209-00001
M17/210-00001		50	32.2	106	PE	0.195 BC	XL polyolefin	2 SC AL/MY	0.895	22.7	57.2	85.1	Use in new design of M17/67
M17/211-00001		72	23.0	75.5	SCPE PE SCPE	0.0477 7/0.0159 TC	XL polyolefin	TC AL/MY	0.405	10.3	11.0	16.4	Use in new designs of M17/126
M17/211-00002		72	23.0	75.5	SCPE PE SCPE	0.0477 7/0.0159 TC	XL polyolefin w/armor	TC AL/MY	0.475	12.1	13.5	20.1	Armored M17/211-00001
M17/212-00001		50	32.2	106	PE	0.195 BC	XL polyolefin	2 SC AL/MY	0.895	22.7	57.2	85.1	Use in new designs of M17/160
M17/213-00001		50	32.2	106	PE	0.0888 7/0.0296 BC	XL polyolefin	BC AL/MY	0.405	10.3	12.1	18.0	Use in new designs of M17/163
M17/214-00001		50	32.2	106	PE	0.0888 7/0.0296 SC	XL polyolefin	2 SC AL/MY	0.425	10.8	15.4	22.9	Use in new designs of M17/164-00001
M17/215-00001		50	32.2	106	PE	0.106 BC	XL polyolefin	2 BC AL/MY	0.545	13.8	24.8	36.9	Use in new designs of M17/165

California

1959 East Cashdan Street, Rancho Dominguez, CA 90220
 (310) 609-1811 • (800) 326-0006 • FAX: (310) 609-1862
 E-Mail: salesrd@std-wire.com

Arizona

3120 West Thomas Road, Bldg. #801, Phoenix, AZ 85017
 (602) 269-2501 • (800) 325-6478 • FAX: (602) 278-7134
 E-Mail: salesphx@std-wire.com



Standard Wire & Cable Co.

M/17 Number	Catalog No.	Nom. Imp. (ohms)	Cap. pF per		Dielect. Mat.	Size (in.) and Type of Inner Conductor	Jacket	Shield	Overall Diameter		Weight		Remarks
			(ft)	(m)					(in)	(mm)	(lbs / 100ft)	(kgs / 100m)	
M17/216-00001		50	32.2	106	PE	0.195 BC	XL polyolefin	BC AL/MY	0.870	22.1	52.1	77.5	Use in new designs of M17/166
M17/217-00001		50	32.2	106	PE	0.0189 7/.0063 CCS	XL polyolefin	TC AL/MY	0.110	2.8	1.0	1.5	Use in new designs of M17/173
M17/218-00001		125	11.0	36.1	Air space PE	0.0253 CCS	XL polyolefin	BC AL/MY	0.405	10.3	8.8	13.1	Use in new designs of M17/31
M17/218-00002		125	11.0	36.1	Air space PE	0.0253 CCS	XL polyolefin w/armor	BC AL/MY	0.475	12.1	13.8	20.5	Armored M17/218-00001

California

1959 East Cashdan Street, Rancho Dominguez, CA 90220
 (310) 609-1811 • (800) 326-0006 • FAX: (310) 609-1862
 E-Mail: salesrd@std-wire.com

Arizona

3120 West Thomas Road, Bldg. #801, Phoenix, AZ 85017
 (602) 269-2501 • (800) 325-6478 • FAX: (602) 278-7134
 E-Mail: salesphx@std-wire.com



Standard Wire & Cable Co.

RG/U Cable Descriptions

RG/U No.	Catalog Number	Nom. Imp. (ohms)	Cap. pF per (ft) (m)		Dielect. Mat.	Size (in.) and Type of Inner Conductor	Jacket	Shield	Overall Diameter (in) (mm)		Weight (lbs / (kgs / 100ft) 100m)		Remarks
1						Waveguide							
2						Waveguide							
3						Waveguide			0.226	5.74			
4	507-4	50	30.0	98.4	PE	0.0320 BC	PVC-I	2 BC	0.226	5.74	2.5	3.7	Superseded by M17/28 - RG58
5	507-5	52.5	28.5	93.5	PE	0.0508 BC	PVC-I	2 BC	0.332	8.43	8.6	13	Superseded by M17/73 - RG212
5A	507-5A	50	30.8	101	PE	0.0508 S	PVC-II	2 S	0.328	8.33	8.3	12	Superseded by M17/73 - RG212
*5B	507-5B	50	30.8	101	PE	0.0508 S	PVC-IIA	2 S	0.338	8.59	8.7	13	Superseded by M17/73 - RG212
6	507-6	75	20.0	65.6	PE	0.0285 CW	PVC-II	BC-S	0.332	8.43	8.2	12	Superseded by M17/2 - RG6
*6A	507-6A	75	20.0	65.6	PE	0.0285 CW	PVC-IIA	BC-S	0.332	8.43	8.2	12	Superseded by M17/2 - RG6
7	507-7	95	12.5	41.0	Air space PE	0.0359 BC	PVC-I	BC	0.370	9.40	8.0	12	Superseded by M17/31 - RG63
8	507-8	52	29.5	96.8	PE	7/21 BC	PVC-I	BC	0.405	10.3	10.5	15.6	Superseded by M17/74 - RG213
*8A	507-8A	52	29.5	96.8	PE	7/21 BC	PVC-IIA	BC	0.405	10.3	10.3	15.3	Superseded by M17/74 - RG213
9	507-9	50	30.0	98.4	PE	7/21 S	PVC-II	BC-S	0.420	10.7	14.0	20.8	Superseded by M17/75 - RG214
9A	507-9A	50	30.0	98.4	PE	7/21 S	PVC-II	2 S	0.420	10.7	14.0	20.8	Superseded by M17/75 - RG214
*9B	507-9B	50	30.0	98.4	PE	7/21 S	PVC-IIA	2 S	0.420	10.7	14.0	20.8	Superseded by M17/75 - RG214
10	507-10	52	29.5	96.8	PE	7/21 BC	PVC-II w/armor	BC	0.475	12.1	14.6	21.7	Superseded by M17/74 - RG215
*10A	507-10A	52	29.5	96.8	PE	7/21 BC	PVC-IIA w/armor	BC	0.475	12.1	14.6	21.7	Superseded by M17/74 - RG215/U
11	507-11	75	20.5	67.3	PE	7/26 TC	PVC-I	BC	0.405	10.3	9.8	15	Superseded by M17/6 - RG11
*11A	507-11A	75	20.5	67.3	PE	7/26 TC	PVC-IIA	BC	0.405	10.3	9.8	15	Superseded by M17/6 - RG11
12	507-12	75	20.5	67.3	PE	7/26 TC	PVC-II w/armor	BC	0.475	12.1	14.4	21.4	Superseded by M17/6 - RG12
*12A	507-12A	75	20.5	67.3	PE	7/26 TC	PVC-IIA w/armor	BC	0.475	12.1	14.4	21.4	Superseded by M17/6 - RG12
13	507-13	74	20.5	67.3	PE	7/26 TC	PVC-I	2 BC	0.420	10.7	12.1	18.0	Superseded by M17/77 - RG216
*13A	507-13A	74	20.5	67.3	PE	7/26 TC	PVC-IIA	2 BC	0.420	10.7	12.1	18.0	Superseded by M17/77 - RG216
14	507-14	52	29.5	96.8	PE	0.1020 BC	PVC-II	2 BC	0.545	13.8	21.6	32.1	Superseded by M17/78 - RG217
*14A	507-14A	52	29.5	96.8	PE	0.1020 BC	PVC-IIA	2 BC	0.545	13.8	21.6	32.1	Superseded by M17/78 - RG217
15	507-15	76	20.0	65.6	PE	0.0571 CW	PVC-I	2 BC	0.545	13.8	19.6	29.2	
16	507-16	52	29.5	96.8	PE	0.125 BC tube	PVC-I	BC	0.630	16.0	25.4	37.8	
17	507-17	52	29.5	96.8	PE	0.188 BC	PVC-II	BC	0.879	22.3	46.3	68.9	Superseded by M17/79 - RG218
*17A	507-17A	52	29.5	96.8	PE	0.188 BC	PVC-IIA	BC	0.870	22.1	46.7	69.5	Superseded by M17/79 - RG218
17B	507-17B	52	29.5	96.8	PE	0.188 BC	PVC-IIA	2 S	0.940	23.9	47.0	69.9	CANCELED reassigned as RG177/U
18	507-18	52	29.5	96.8	PE	0.188 BC	PVC-IA w/armor	BC	0.945	24.0	58.5	87.1	Superseded by M17/79 - RG219
*18A	507-18A	52	29.5	96.8	PE	0.188 BC	PVC-IIA w/armor	BC	0.945	24.0	58.5	87.1	Superseded by M17/79 - RG219
19	507-19	52	29.5	96.8	PE	0.250 BC	PVC-II	BC	1.120	28.45	74.5	111	Superseded by M17/81-00001
*19A	507-19A	52	29.5	96.8	PE	0.250 BC	PVC-IIA	BC	1.120	28.45	74.0	110	Superseded by M17/81-00001
20	507-20	52	29.5	96.8	PE	0.250 BC	PVC-II w/armor	BC	1.195	30.35	92.5	138	Superseded by M17/81-00002

* Covered by specification Mil-C-17

California

1959 East Cashdan Street, Rancho Dominguez, CA 90220
 (310) 609-1811 • (800) 326-0006 • FAX: (310) 609-1862
 E-Mail: salesrd@std-wire.com

Arizona

3120 West Thomas Road, Bldg. #801, Phoenix, AZ 85017
 (602) 269-2501 • (800) 325-6478 • FAX: (602) 278-7134
 E-Mail: salesphx@std-wire.com



Standard Wire & Cable Co.

RG/U No.	Catalog Number	Nom. Imp. (ohms)	Cap. pF per (ft) (m)		Dielect. Mat.	Size (in.) and Type of Inner Conductor	Jacket	Shield	Overall Diameter (in) (mm)		Weight (lbs / 100ft) (kgs / 100m)		Remarks
*20A	507-20A	52	29.6	97.1	PE	0.250 BC	PVC-IIA w/armor	BC	1.178	29.921	92.5	138	Superseded by M17/81-00002
21	507-21	53	29.0	95.1	PE	0.0508 N	PVC-II	2 S	0.332	8.43	8.3	12	Superseded by M17/162-00001
*21A	507-21A	53	29.0	95.1	PE	0.0508 N	PVC-IIA	2 S	0.332	8.43	8.4	13	Superseded by M17/162-00001
22	507-22	95	16.3	53.5	PE	2 cond. 7/0.0152 BC	PVC-I	TC	0.405	10.3	10.3	15.3	Balanced twin conductor Superseded by M17/15 - RG22
22A	507-22A	95	16.3	53.5	PE	2 cond. 7/0.0152 BC	PVC-II	2 TC	0.420	10.7	13.0	17.7	Balanced twin conductor Superseded by M17/15 - RG22
*22B	507-22B	95	16.3	53.5	PE	2 cond. 7/0.0152 BC	PVC-IIA	2 TC	0.420	10.7	13.0	17.9	Balanced twin conductor Superseded by M17/15 - RG22
23	507-23	125	12.0	39.4	PE	2 cond. 7/21 BC	PVC-I	2 BC	0.650 x 0.945	16.5 x 24.0	53.0	56.5	Superseded by M17/16 - RG23
*23A	507-23A	125	12.0	39.4	PE	2 cond. 7/21 BC	PVC-IIA	2 BC	0.650 x 0.945	16.5 x 24.0	53.0	53.6	Superseded by M17/16 - RG23
24	507-24	125	12.0	39.4	PE	2 cond. 7/21 BC	PVC-I w/armor	2 BC	0.735 x 1.034	18.7 x 26.3	73.0	64.0	Superseded by M17/16 - RG24
*24A	507-24A	125	12.0	39.4	PE	2 cond. 7/21 BC	PVC-IIA w/armor	2 BC	0.735 x 1.034	18.7 x 26.3	73.0	61.0	Superseded by M17/16 - RG24
*25	507-25	48	50.0	164	Rubber	19/0.0117 TC	Rubber-IV	2 TC	0.565	14.4	22.5	30.5	High voltage pulse cable
*25A	507-25A	48	50.0	164	Rubber	19/0.0117 TC	Rubber-IV	2 TC	0.505	12.8	22.5	30.5	High voltage cable Superseded by M17/19
*26	507-26	48	50.0	164	Rubber	19/0.0117 TC	Rubber-IV w/armor	TC	0.525	13.3	21.0	28.1	Pulse cable, armored
*26A	507-26A	48	50.0	164	Rubber	19/0.0117 TC	Rubber-IV w/armor	TC	0.505	12.8	21.0	28.1	Pulse cable, armored Superseded by M17/21
27	507-27	48	50.0	164	Rubber	19/0.0185 TC	PVC-II	TC	0.675	17.1	33.0	45.2	High voltage pulse cable
*27A	507-27A	48	50.0	164	Rubber	19/0.0185 TC	Rubber-IV w/armor	TC	0.670	17.0	33.0	45.2	High voltage pulse cable Superseded by M17/22
28	507-28	50	50.0	164	Rubber	19/0.0185 TC	Rubber-IV	TC GS	0.805	20.4	40.0	55.1	Pulse cable
28A	507-28A	50	50.0	164	Rubber	19/0.0185 TC	Rubber-IV w/armor	TC	0.805	20.4	40.0	55.1	Pulse cable 55°C use
*28B	507-28B	48	50.0	164	Rubber	19/0.0185 TC	Rubber-IV	TC GS	0.750 max.	19.1 max.	37.0	55.1	Superseded by M17/23 - RG28
29	507-29	53.5	28.5	93.5	PE	0.0320 BC	PE-III	TC	0.184	4.67	2.2	3.3	Superseded by M17/28 - RG58
30	507-30	50	27.0	88.6	Copo.	7/26 BC	PVC-I	BC	0.250	6.35	4.4	6.5	Superseded by M17/73 - RG212
31	507-31	51	31.0	102	Copo.	7/21 BC	PVC-I	BC	0.405	10.3	10.6	15.8	Superseded by M17/74 - RG213
32	507-32	51	29.0	95.1	Copo.	7/21 BC	PVC-I w/armor	BC	0.465	11.8	14.1	21.0	Superseded by M17/74 - RG215
33	507-33	51	30.0	98.4	PE	0.1019 BC	Lead	None	0.470	11.9	39.0	58.0	
34	507-34	71	21.5	70.5	PE	7/21 BC	PVC-I	BC	0.625	15.9	22.9	34.1	Superseded by M17/24 - RG34
34A	507-34A	71	21.5	70.5	PE	7/0.0249 BC	PVC-IIA	BC	0.630	16.0	22.9	34.1	Superseded by M17/24 - RG34
*34B	507-34B	75	21.5	70.5	PE	7/0.0249 BC	PVC-IIA	BC	0.630	16.0	22.4	33.3	Superseded by M17/24 - RG34
35	507-35	71	21.5	70.5	PE	0.1144 BC	PVC-II w/armor	BC	0.945	24.0	45.4	67.6	Superseded by M17/64 - RG35
35A	507-35A	71	21.5	70.5	PE	0.1045 BC	PVC-IIA w/armor	BC	0.945	24.0	54.5	68.2	Superseded by M17/64 - RG35
*35B	507-35B	75	21.5	70.5	PE	0.1045 BC	PVC-IIA w/armor	BC	0.945 max.	24.0 max.	54.5	78.1	Superseded by M17/64 - RG35

* Covered by specification Mil-C-17

California

1959 East Cashdan Street, Rancho Dominguez, CA 90220
(310) 609-1811 • (800) 326-0006 • FAX: (310) 609-1862

E-Mail: salesrd@std-wire.com

Arizona

3120 West Thomas Road, Bldg. #801, Phoenix, AZ 85017
(602) 269-2501 • (800) 325-6478 • FAX: (602) 278-7134

E-Mail: salesphx@std-wire.com



Standard Wire & Cable Co.

RG/U No.	Catalog Number	Nom. Imp. (ohms)	Cap. pF per (ft) (m)		Dielect. Mat.	Size (in.) and Type of Inner Conductor	Jacket	Shield	Overall Diameter (in) (mm)		Weight (lbs / 100ft) (kgs / 100m)		Remarks
36	507-36	69	22.0	72.2	PE	0.1620 BC	PVC-I	BC	1.180	29.97	80.5	119.8	Armored
37	507-37	52.5	38.0	125	Rubber-C	0.0320 TC	PE-III	TC	0.210	5.33	4.0	6.0	Superseded by RG58/U
38	507-38	52.5	38.0	125	Rubber-C	0.0453 TC	PE-III	2 TC	0.312	7.92	11.0	16.4	Superseded by RG5/U
39	507-39	72.5	28.6	93.8	Rubber-C	0.0253 TCW	PE-III	2 TC	0.312	7.92	10.0	14.9	Superseded by RG6/U, RG59/U
40	507-40	72.5	28.0	91.9	Rubber-C	0.0253 TCW	Rubber-IV	2 TC	0.420	10.7	15.0	22.3	Superseded by RG6/U
41	507-41	67.5	27.6	90.6	Rubber-C	16/30 TC	Rubber-IV	TC	0.425	10.8	15.0	22.3	
42	507-42	78.6	20.0	65.6	PE	0.0285 N	PVC-II	2 S	0.342	8.69	5.0	7.4	Superseded by M17/62-00001
43	507-43	95	17.6	57.7	Rubber-B	2 cond. 7/21 BC	PVC-I	BC	0.617	15.7	40.0	59.5	Superseded by M17/56 - RG131
44	507-44	Stub supported coaxial											
45	507-45	Stub supported coaxial											
46	507-46	Stub supported coaxial											
47	507-47	Stub supported coaxial											
48	507-48	Waveguide											
49	507-49	Waveguide											
50	507-50	Waveguide											
51	507-51	Waveguide											
52	507-52	Waveguide											
53	507-53	Waveguide											
54	507-54	58	27.0	88.6	PE	7/26 BC	PVC-I	BC	0.275	6.99	4.5	6.7	Superseded by M17/73 - RG212
54A	507-54A	58	26.5	86.9	PE	7/0152 BC	PE-III	TC	0.250	6.35	4.1	6.1	Superseded by M17/73 - RG212
55	507-55	53.5	28.5	93.5	PE	0.320 BC	PE-III	2 TC	0.200	5.08	3.2	4.8	Superseded by M17/84 - RG223
55A	507-55A	50	28.5	93.5	PE	0.035 S	PVC-IIA	2 S	0.200	5.08	3.6	5.4	Superseded by M17/84 - RG223
*55B	507-55B	53	28.5	93.5	PE	0.032 S	PE-III	2 TC	0.200 max.	5.08 max.	3.6	5.4	Superseded by M17/84 - RG223
56	507-56	48	50.0	164	Rubber-C	19/0117 BC	PVC-I	2 BC	0.535	13.59	24.3	36.2	Pulse cable W.E. KS 9351
57	507-57	95	17.0	55.8	PE	2 cond. 7/21 BC	PVC-I	TC	0.625	15.88	22.5	33.5	Superseded by M17/56 - RG130
*57A	507-57A	95	17.0	55.8	PE	2 cond. 7/21 BC	PVC-IIA	TC	0.625	15.88	22.5	33.5	Superseded by M17/56 - RG130
58	507-58	53.5	28.5	93.5	PE	0.0320 BC	PVC-I	TC	0.195	4.95	2.7	4.0	Superseded by M17/28 - RG58
58A	507-58A	50	30.0	98.4	PE	19/33 TC	PVC-I	TC	0.195	4.95	2.7	4.0	Superseded by M17/28 - RG58
58B	507-58B	53.5	28.5	93.5	PE	0.0320 BC	PVC-IIA	TC	0.195	4.95	2.6	3.9	Superseded by M17/28 - RG58
*58C	507-58C	50	30.0	98.4	PE	19/33 TC	PVC-IIA	TC	0.195	4.95	2.6	3.9	Swept superseded by M17/28 Unswep superseded by M17/155-00001
59	507-59	73	21.0	68.9	PE	0.0253 CW	PVC-I	BC	0.242	6.15	3.2	4.8	Superseded by M17/29 - RG59
59A	507-59A	75	21.0	68.9	PE	0.0253 CW	PVC-IIA	BC	0.242	6.15	3.2	4.8	Superseded by M17/29 - RG59
*59B	507-59B	75	21.0	68.9	PE	0.023 CW	PVC-IIA	BC	0.242	6.15	3.2	4.8	Superseded by M17/29 - RG59
60	507-60	50	39.0	128	Rubber	0.0508 stranded BC	Rubber-IV	BC	0.425	10.8	15.0	22.3	Pulse cable
61	507-61	Special 500 ohm line											
62	507-62	93	13.5	44.3	Air space PE	0.0253 CW	PVC-I	BC	0.242	6.15	3.8	5.7	Superseded by M17/30 - RG62
*62A	507-62A	93	13.5	44.3	Air space PE	0.0253 CW	PVC-I	BC	0.242	6.15	3.8	5.7	Superseded by M17/30 - RG62

* Covered by specification Mil-C-17

California

1959 East Cashdan Street, Rancho Dominguez, CA 90220
 (310) 609-1811 • (800) 326-0006 • FAX: (310) 609-1862
 E-Mail: salesrd@std-wire.com

Arizona

3120 West Thomas Road, Bldg. #801, Phoenix, AZ 85017
 (602) 269-2501 • (800) 325-6478 • FAX: (602) 278-7134
 E-Mail: salesphx@std-wire.com



Standard Wire & Cable Co.

RG/U No.	Catalog Number	Nom. Imp. (ohms)		Cap. pF per (ft) (m)	Dielect. Mat.	Size (in.) and Type of Inner Conductor	Jacket	Shield	Overall Diameter (in) (mm)		Weight (lbs / 100ft) (kgs / 100m)		Remarks
62B	507-62B	93	13.5	44.3	Air space PE	7/32 CW	PVC-IIA	BC	0.242	6.15	3.8	5.7	Superseded by M17/30 - RG62
63	507-63	125	10.0	32.8	Air space PE	0.0253 CW	PVC-I	BC	0.405	10.3	8.3	12	Superseded by M17/31 - RG63
63A	507-63A	125	10.0	32.8	Air space PE	0.0253 BC	PVC-I	BC	0.405	10.3	8.3	12	Superseded by M17/31 - RG63
*63B	507-63B	125	10.0	32.8	Air space PE	0.0253 CW	PVC-IIA	BC	0.405	10.3	8.4	13	Low capacitance air space Superseded by M17/31 - RG63
*64	507-64	48	50.0	164	Rubber-IV	19/0.0117 TC	Rubber-IV	2 TC	0.495	12.6	22.0	32.7	Pulse cable
*64A	507-64A	48	50.0	164	Rubber-IV	19/0.0117 TC	Rubber-IV	2 TC	0.475	12.1	20.5	30.5	Pulse cable Superseded by M17/33 - RG65
65	507-65	950	44.0	144	PE	0.0080 Formex F	PVC-I	BC	0.405	10.3	11.0	16.4	Delay cable high impedance video Superseded by M17/84 - RG65
*65A	507-65A	950	44.0	144	PE	0.0080 Formex F	PVC-IIA	BC	0.405	10.3	9.6	14	Delay cable high impedance video Superseded by M17/84 - RG65
66	507-66	Waveguide											
67	507-67	Waveguide											
68	507-68	Waveguide											
69	507-69	Waveguide											
70	507-70	Not assigned											
71	507-71	93	13.5	44.3	Air space PE	0.0253 CW	PVC-I	2 TC	0.245	6.22	5.0	7.4	Superseded by M17/90 - RG71
71A	507-71A	93	13.5	44.3	Air space PE	0.0253 CW	PE-III	2 TC	0.245	6.22	4.6	6.8	Superseded by M17/90 - RG71
*71B	507-71B	93	14.5 max.	47.6 max.	Air space PE	0.0253 CW	PE-IIIA	2 TC	0.250 max.	6.35 max.	4.6	6.8	Superseded by M17/90 - RG71
72	507-72	150	7.8	26	Air space PE	0.0253 CW	PVC-I	BC	0.630	16.0	16.9	25.1	Low capacitance
73	507-73	25	61.8	203	PE	0.0320 BC	None	2 BC	0.175	4.45	3.1	4.6	Low capacitance
74	507-74	52	29.6	97.1	PE	0.1020 BC	PVC-II w/armor	2 BC	0.603	15.3	31.0	46.1	Superseded by M17/65-00002
*74A	507-74A	52	29.6	97.1	PE	0.1020 BC	PVC-IIA w/armor	2 BC	0.603	15.3	31.0	46.1	Superseded by M17/65-00002
75	507-75	Waveguide											
76	507-76	Stub supported coaxial											
77A	507-77A	48	50.0	164	Rubber	19/0.0117 TC	PVC-IIA	2 TC	0.450	11.4	19.5	29.0	Pulse cable
78A	507-78A	48	50.0	164	Rubber	19/0.0117 TC	PVC-IIA	TC	0.420	10.7	14.9	22.2	Pulse cable
79	507-79	125	10.0	32.8	Air space PE	0.0253 CW	PVC-I w/armor	BC	0.475	12.1	13.8	20.5	Superseded by M17/31 - RG79
79A	507-79A	125	11.0 max.	36.1 max.	Air space PE	0.0253 CW	PVC-I w/armor	BC	0.475	12.1	13.6	20.2	Superseded by M17/31 - RG79
*79B	507-79B	125	11.0 max.	36.1 max.	Air space PE	0.0253 CW	PVC-IIA w/armor	BC	0.475	12.1	13.8	20.5	RG63B/U with armor Superseded by M17/31 - RG79
80	507-80	Bead supported coaxial											
*81	507-81	50	37.0	121	Mag. Ox.	0.0625 BC	None	BC tube	0.325	8.26	17.2	25.6	Semirigid high temperature
*82	507-82	50	36.0	118	Mag. Ox.	0.1250 BC	None	BC tube	0.750	19.1	69.8	104	Semirigid high temperature
83	507-83	35	44.0	144	PE	0.1020 BC	PVC-I	BC	0.405	10.3	12.0	17.9	CANCELED
*84A	507-84A	75	21.5	70.5	PE	0.1045 BC	PVC-IIA w/lead	BC	1.000	25.4	132.5	197.2	RG35B/U with lead jacket
*85A	507-85A	75	21.5	70.5	PE	0.1045 BC	PVC-IIA w/lead	BC	1.565	39.8	291.0	433.1	RG84/U with special armor
*86	507-86	200	7.8	26	PE	2 cond. 7/21 BC	None	None	0.650 x 0.300	16.5 x 7.62	10.0	14.9	Twin-lead

* Covered by specification Mil-C-17

California

1959 East Cashdan Street, Rancho Dominguez, CA 90220
(310) 609-1811 • (800) 326-0006 • FAX: (310) 609-1862
E-Mail: salesrd@std-wire.com

Arizona

3120 West Thomas Road, Bldg. #801, Phoenix, AZ 85017
(602) 269-2501 • (800) 325-6478 • FAX: (602) 278-7134
E-Mail: salesphx@std-wire.com



Standard Wire & Cable Co.

RG/U No.	Catalog Number	Nom. Imp. (ohms)	Cap. pF per (ft) (m)		Dielect. Mat.	Size (in.) and Type of Inner Conductor	Jacket	Shield	Overall Diameter (in) (mm)		Weight (lbs / (kgs / 100ft) 100m)		Remarks
87	507-87	50	29.5	96.8	TFE	7/20 S	FG-V	BC & S	0.425	10.8	18.0	26.8	Superseded by M17/127 - RG393
*87A	507-87A	50	29.5	96.8	TFE	7/20 S	FG-V	2 S	0.425	10.8	18.0	26.8	Superseded by M17/127 - RG393
*88	507-88	48	50.0	164	Rubber	19/0.0117 TC	PVC-I	4 TC	0.515 max.	13.1 max.	21.1	31.4	High voltage pulse cable
*88A	507-88A	48	50.0	164	Rubber	19/0.0117 TC	PVC-IIA	4 TC	0.515 max.	13.1 max.	21.1	31.4	High voltage pulse cable
88B	507-88B	48	50.0	164	Rubber	19/0.0117 TC	Rubber-IV	4 TC	0.565	14.4	23.8	35.4	High voltage pulse cable
89	507-89	125	10.0	32.8	Air space PE	0.0253 CW	PVC-I	BC	0.632	16.1	20.0	29.8	Superseded by M17/31 - RG63
90	507-90	50	30.8	101	PE	7/24 S	PVC-IIA	2 TC 1 GS	0.425	10.8	-	-	Carrier frequency communication
91	507-91	Waveguide											
92	507-92	46	-	-	SS TFE	0.375 BC	None	BC tube	-	-	-	-	TFE bead supported coaxial line
93	507-93	50	29.0	95.1	TFE tape	19/18 BC	FG-V	BC	0.710	18.0	47.5	70.7	Superseded by M17/72 - RG211
*94	507-94	50	29.0	95.1	TFE tape	19/23 S	FG-V	2 BC	0.445	11.3	27.0	40.2	Superseded by M17/87-00001
94A	507-94A	50	29.0	95.1	TFE tape	19/22 S	FG-V	2 BC	0.500	12.7	44.0	65.5	Superseded by M17/87-00001
95	507-95	Waveguide											
96	507-96	Waveguide											
97	507-97	Waveguide											
98	507-98	Waveguide											
99	507-99	Waveguide											
100	507-100	35	44.0	144	PE	19/0.0147 BC	PVC-I	BC	0.242	6.15	4.6	6.8	Use up to 1,000 MHz
101	507-101	75	-	-	Rubber	0.0641 BC	-	TC	0.588	14.9	-	-	
102	507-102	140	-	-	Rubber	2 cond. 0.0808 BC	-	TC	1.088	27.64	-	-	
103	507-103	Waveguide											
104	507-104	Waveguide											
105	507-105	Waveguide											
106	507-106	Waveguide											
107	507-107	Waveguide											
108	507-108	78	24.5	80.4	PE	2 cond. 7/28 TC	PVC-II	TC	0.235	5.97	3.2	4.8	Superseded by M17/45 - RG108
*108A	507-108A	78	24.5	80.4	PE	2 cond. 7/28 TC	PVC-IIA	TC	0.235	5.97	3.2	4.8	Shielded twisted pair Superseded by M17/45 - RG108
109	507-109	Waveguide											
110	507-110	Waveguide											
111	507-111	95	16.3	53.5	PE	2 cond. 7/0.0152 BC	PVC-II w/armor	2 TC	0.478	12.1	14.5	21.6	Superseded by M17/15 - RG111
*111A	507-111A	95	16.3	53.5	PE	2 cond. 7/0.0152 BC	PVC-IIA w/armor	2 TC	0.478	12.1	14.5	21.6	Superseded by M17/15 - RG111
112	507-112	Waveguide											
113	507-113	Waveguide											
114	507-114	185	6.5	21	Air space PE	0.0070 CW	PVC-I	BC	0.405	10.3	8.7	12.9	Superseded by M17/47 - RG114
*114A	507-114A	185	6.5	21	Air space PE	0.0070 CW	PVC-IIA	BC	0.405	10.3	8.7	12.9	Superseded by M17/47 - RG114

* Covered by specification Mil-C-17

California

1959 East Cashdan Street, Rancho Dominguez, CA 90220
 (310) 609-1811 • (800) 326-0006 • FAX: (310) 609-1862
 E-Mail: salesrd@std-wire.com

Arizona

3120 West Thomas Road, Bldg. #801, Phoenix, AZ 85017
 (602) 269-2501 • (800) 325-6478 • FAX: (602) 278-7134
 E-Mail: salesphx@std-wire.com



Standard Wire & Cable Co.

RG/U No.	Catalog Number	Nom. Imp. (ohms)	Cap. pF per (ft) (m)		Dielect. Mat.	Size (in.) and Type of Inner Conductor	Jacket	Shield	Overall Diameter (in) (mm)		Weight (lbs / (kgs / 100ft) (100m))		Remarks
*115	507-115	50	29.0	95.1	TFE tape	7/21 S	FG-V	2 S	0.375	9.53	18.0	26.8	For use where expansion & contraction are problem Superseded by M17/168-00001
*115A	507-115A	50	29.0	95.1	TFE tape	7/21 S	FG-V	2 S	0.415	10.5	18.0	26.8	Superseded by M17/168-00001
*116	507-116	50	29.5	96.8	TFE	7/20 S	FG-V w/armor	2 S	0.475	12.1	19.8	29.5	Superseded by M17/86-00002
*117	507-117	50	29.5	96.8	TFE	0.188 BC	FG-V	BC	0.730	18.5	64.1	95.4	Superseded by M17/72 - RG211
*117A	507-117A	50	29.5	96.8	TFE	0.188 BC	FG-V	BC	0.730	18.5	64.1	95.4	Superseded by M17/72 - RG211
*118	507-118	50	29.0	95.1	TFE	0.188 BC	FG-V w/armor	BC	0.780	19.8	68.2	101.5	Superseded by M17/161-00002
*118A	507-118A	50	29.0	95.1	TFE	0.188 BC	FG-V w/armor	BC	0.780	19.8	68.2	101.5	Superseded by M17/161-00002
*119	507-119	50	29.0	95.1	TFE	0.102 BC	FG-V	2 BC	0.465	11.8	22.8	33.9	Superseded by M17/52 - RG119
*120	507-120	50	29.0	95.1	TFE	0.102 BC	FG-V w/armor	2 BC	0.523	13.3	28.6	42.6	Superseded by M17/52 - RG120
121	507-121	Waveguide											
*122	507-122	50	30.8	101	PE	27/36 TC	PVC-IIA	TC	0.160	4.06	1.6	2.4	Superseded by M17/54 - RG122 Superseded by M17/187-00001
123	507-123	Not assigned											
124	507-124	73	20.3	66.6	TFE tape	0.0253 TCW	FG-V	TC	0.240	6.10	21.0	31.3	Superseded by M17/110 - RG302
125	507-125	150	7.8	26	Air space PE	0.0159 CW	PVC-IIA	BC	0.600	15.2	18.0	26.8	Low capacitance
*126	507-126	50	29.0	95.1	TFE	7/24 HR	FG-V	HR	0.280	7.11	7.0	10	Superseded by M17/109 - RG301
128	507-128	50	-	-	SS TFE	0.644 BC	None	BC tube	1.625	41.3	-	-	TFE bead supported coaxial line
129	507-129	Flexible Waveguide											
*130	507-130	95	17.0	55.8	PE	2 cond. 7/21 BC	PVC-I	TC	0.625	15.9	30.0	44.6	RG 57A/U with twisted inner conductors flex. Superseded by M17/56 - RG130
*131	507-131	95	17.0	55.8	PE	2 cond. 7/21 BC	PVC-I w/armor	TC	0.710	18.0	40.0	59.5	RG 130/U with armor. Superseded by M17/56 - RG131
132	507-132	Waveguide											
133	507-133	95	16.2	53.1	PE	0.0285 BC	PVC-I	BC	0.405	10.3	9.4	14	Superseded by M17/100 - RG133
*133A	507-133A	95	16.2	53.1	PE	0.0253 BC	PVC-IIA	BC	0.405	10.3	9.4	14	NATO type NWR-7 Superseded by M17/100 - RG133
134	507-134	185	6.5	21	SS TFE	0.0126 BC	None	Brass	0.450	11.4	-	-	TFE bead supported coaxial line
135	507-135	Waveguide											
136	507-136	Waveguide											
137	507-137	Waveguide											
138	507-138	Waveguide											
139	507-139	Waveguide											
*140	507-140	75	21.0	68.9	TFE	0.0250 SCCS	FG-V	S	0.233	5.92	5.6	8.3	Superseded by M17/110 - RG302
141	507-141	50	29.4	96.5	TFE	0.0359 SCCS	FG-V	S	0.190	4.83	3.5	5.2	Similar to RG 58/U with TFE core Superseded by M17/111 - RG303
*141A	507-141A	50	29.4	96.5	TFE	0.0390 SCCS	FG-V	S	0.190	4.83	3.5	5.2	High temperature Similar to RG58C/U Superseded by M17/111- RG303
142	507-142	50	29.4	96.5	TFE	0.0359 SCCS	FG-V	2 S	0.195	4.95	4.7	7.0	Superseded by M17/60 - RG142
*142A	507-142A	50	29.4	96.5	TFE	0.0390 SCCS	FG-V	2 S	0.195	4.95	4.7	7.0	Superseded by M17/60 - RG142

* Covered by specification Mil-C-17

California

1959 East Cashdan Street, Rancho Dominguez, CA 90220
(310) 609-1811 • (800) 326-0006 • FAX: (310) 609-1862
E-Mail: salesrd@std-wire.com

Arizona

3120 West Thomas Road, Bldg. #801, Phoenix, AZ 85017
(602) 269-2501 • (800) 325-6478 • FAX: (602) 278-7134
E-Mail: salesphx@std-wire.com



Standard Wire & Cable Co.

RG/U No.	Catalog Number	Nom. Imp. (ohms)		Cap. pF per (ft) (m)		Dielect. Mat.	Size (in.) and Type of Inner Conductor	Jacket	Shield	Overall Diameter (in) (mm)		Weight (lbs / (kgs / 100ft) (100m))		Remarks
*142B	507-142B	50	29.4	96.5		TFE	0.0390 SCCS	FEP	2 S	0.195	4.95	4.7	7.0	NATO type NWR-25 Superseded by M17/60 - RG142
143	507-143	50	29.4	96.5		TFE	0.0570 SCCS	FG-V	2 S	0.325	8.26	11.4	17.0	Superseded by M17/112 - RG304
*143A	507-143A	50	29.4	96.5		TFE	0.0590 SCCS	FG-V	2 S	0.325	8.26	10.9	16.2	Superseded by M17/112 - RG304
*144	507-144	75	20.5	67.3		TFE	7/25 SCCS	FG-V	S	0.410	10.4	14.0	20.8	Superseded by M17/62 - RG144
145	507-145	75	14.6	47.9		Air space PE	2 cond. 0.0720 BC	Lead-tar	BC tube	-	-	-	-	
146	507-146	190	6.0	20		Air space TFE	0.0070 CW	FG-V	BC	0.375	9.53	10.8	16.1	CANCELED
147	507-147	52	29.5	96.8		PE	0.250 BC	PVC-I w/armor	BC	1.938	49.23	-	-	Superseded by M17/81-00002
148	507-148	52	29.5	96.8		PE	7/21 BC	PVC-I w/armor	BC	0.800	20.3	-	-	Superseded by M17/74 - RG213
*149	507-149	75	20.5	67.3		PE	7/26 TC	PVC-IIA	BC	0.405	10.3	10.0	14.9	Superseded by M17/126 - RG391
*150	507-150	75	20.5	67.3		PE	7/26 TC	PVC-IIA w/armor	BC	0.475	12.1	11.7	17.4	Superseded by M17/126 - RG392
*151	507-151	50	-	-		-	0.125 BC tube	None	BC tube	0.375	9.53	-	-	Bead supported coaxial line
*152	507-152	50	-	-		-	2.60 BC tube	None	BC tube	6.125	155.6	-	-	Bead supported coaxial line
*153	507-153	50	-	-		-	0.664 BC tube	None	BC tube	1.625	41.28	-	-	Bead supported coaxial line
154	507-154	50	-	-		-	1.315 BC tube	None	BC tube	3.125	79.38	-	-	Bead supported coaxial line
155	507-155	50	-	-		-	0.341 BC tube	None	BC tube	0.875	22.2	-	-	Bead supported coaxial line
*156	507-156	50	32.8	108		PE & conductive PE	7/21 TC	PVC-IIA	TC, GS, TC	0.540	13.7	21.1	31.4	Triaxial pulse cable
*157	507-157	50	38.0	125		PE & conductive PE	19/24 TC	PVC-IIA	TC, GS, TC	0.725	18.4	31.7	47.2	Triaxial pulse cable
*158	507-158	25	78.0	256		PE & conductive PE	37/21 TC	PVC-IIA	TC, GS, TC	0.725	18.4	38.0	56.6	Triaxial pulse cable
159	507-159	50	29.0	95.1		TFE tape	0.0320 S	FG-V	S	0.195	4.95	3.5	5.2	Superseded by M17/111 - RG303
160	507-160	125	12.0	39.4		PE	2 cond. 19/27 TC 2 cond. 19/27 BC	PVC-I	BC	1.055	26.80	-	-	Four conductor balanced line
160A	507-160A	125	12.0	39.4		PE	2 cond. 19/27 TC 2 cond. 19/27 BC	PVC-I	BC	1.055	26.80	-	-	Same as RG160/U except copper ribbon braid shield and mylar tape
161	507-161	70	20.9	68.6		TFE	7/38 SCB	nylon	S	0.082	2.08	1.5	2.2	Miniature
162	507-162	175	-	-		SS TFE	0.156 BC tube	None	BC tube	3.065	77.85	-	-	TFE bead supported coaxial line
163	507-163	Waveguide												
*164	507-164	75	20.6	67.6		PE	0.1045 BC	PVC-IIA	BC	0.870	22.1	49.0	72.9	Superseded by M17/64 - RG164
*165	507-165	50	29.5	96.8		TFE	7/20 S	FG-V	S	0.410	10.4	12.0	17.9	Superseded by M17/64 - RG165
*166	507-166	50	29.5	96.8		TFE	7/20 S	FG-V	S	0.470	11.9	14.4	21.4	Superseded by M17/64 - RG166
167	507-167	Waveguide												
168	507-168	Waveguide												
169	507-169	Waveguide												
170	507-170	Waveguide												
171	507-171	Waveguide												
172	507-172	Waveguide												

* Covered by specification Mil-C-17

California

1959 East Cashdan Street, Rancho Dominguez, CA 90220
 (310) 609-1811 • (800) 326-0006 • FAX: (310) 609-1862
 E-Mail: salesrd@std-wire.com

Arizona

3120 West Thomas Road, Bldg. #801, Phoenix, AZ 85017
 (602) 269-2501 • (800) 325-6478 • FAX: (602) 278-7134
 E-Mail: salesphx@std-wire.com

Web Page: www.std-wire.com



Standard Wire & Cable Co.

RG/U No.	Catalog Number	Nom. Imp. (ohms)	Cap. pF per (ft) (m)	Dielect. Mat.	Size (in.) and Type of Inner Conductor	Jacket	Shield	Overall Diameter (in) (mm)	Weight (lbs / (kgs / 100ft) 100m)	Remarks			
173	507-173	Waveguide											
*174	507-174	50	30.8	101	PE	7/34 CW	PVC-I	TC	0.100	2.54	0.90	1.3	Superseded by M17/119 - RG174
*174A	507-174A	50	30.8	101	PE	7/34 CW	PVC-IIA	TC	0.100	2.54	0.90	1.3	Swept superseded by M17/119 - RG174 Unwept superseded by M17/173-00001
175	507-175	Bead supported coaxial line											
*176	507-176	2240	49.0	161	PE	0.135 BC helix	PVC-I	BC	0.405	10.3	12.0	17.9	High impedance delay
*177	507-177	50	30.0	98.4	PE	0.195 BC	PVC-IIA	2 S	0.895	22.7	59.5	88.5	Superseded by M17/67 - RG177
178	507-178	50	29.4	96.5	TFE	7/38 SCW	FEP	S	0.079 max.	2.01 max.	0.54	0.80	Superseded by M17/93 - RG178
*178A	507-178A	50	27.9	91.5	TFE	7/38 SCW	FEP	S	0.075 max.	1.91 max.	0.50	0.74	Superseded by M17/93 - RG178
*178B	507-178B	50	27.9	91.5	TFE	7/38 SCW	FEP-IX	S	0.075 max.	1.91 max.	0.54	0.80	Swept superseded by M17/93 - RG178 Unwept superseded by M17/169-00001
179	507-179	70	20.9	68.6	TFE	7/38 SCCS	FEP	S	0.094 max.	2.39 max.	1.08	1.61	Superseded by M17/94 - RG179
*179A	507-179A	75	20.9	68.6	TFE	7/38 SCCS	FEP	S	0.105 max.	2.67 max.	1.08	1.61	Superseded by M17/94 - RG179
*179B	507-179B	75	20.9	68.6	TFE	7/38 SCCS	FEP-IX	S	0.105 max.	2.67 max.	1.08	1.61	Superseded by M17/94 - RG179
180	507-180	93	15.4	50.5	TFE	7/38 SCCS	FEP	S	0.141 max.	3.58 max.	1.9	2.8	Superseded by M17/95 - RG180
*180A	507-180A	95	15.4	50.5	TFE	7/38 SCCS	FEP	S	0.145 max.	3.68 max.	1.9	2.8	Superseded by M17/95 - RG180
*180B	507-180B	95	15.4	50.5	TFE	7/38 SCCS	FEP-IX	S	0.145 max.	3.68 max.	1.9	2.8	Superseded by M17/95 - RG180
*181	507-181	125	12.0	39.4	PE	2 cond. 7/26 BC	PVC-IIA	BC	0.640	16.3	19.8	29.5	Balanced line
182	507-182	125 each	12.0 each	39.4 each	PE	2 cond. 19/0.0142 BC 2 cond. 19/0.0066 TC	PVC-IIA	2 BC	1.055	26.80	-	-	Dual Twinaxial
183	507-183	50	23.0	75.5	PS helix	0.0251 BC	None	AL tube	0.750	19.1	38.0	56.5	
184	507-184	Waveguide											
185	507-185	2000	-	-	Air space PE	0.0031 RIM helix	PVC-IIA	Magnet wire	0.282	7.16	-	-	Delay line cable
186	507-186	1000	-	-	SS PE	0.0080 TFE Magnet wire helix	PVC-IIA	Magnet wire	0.405	10.3	-	-	Delay line cable
187	507-187	75	19.5	64.0	TFE	7/38 SCCS	TFE	S	0.110 max.	2.79 max.	1.13	1.68	Superseded by M17/136-00001
*187A	507-187A	75	19.5	64.0	TFE	7/38 SCCS	TFE	S	0.110 max.	2.79 max.	1.13	1.68	Superseded by M17/136-00001
*188	507-188	50	29.0	95.1	TFE	7/0.0067 SCCS	TFE	S	0.110 max.	2.79 max.	1.11	1.65	Superseded by M17/138-00001
*188A	507-188A	50	29.0	95.1	TFE	7/0.0067 SCCS	TFE	S	0.110 max.	2.79 max.	1.11	1.65	Superseded by M17/138-00001
189	507-189	50	23.0	75.5	PS helix	0.251 BC	PE-III A	2 S	0.875	22.2	57.0	84.8	Partially air supported by cross-linked polystyrene use RG389
*190	507-190	50	50.0	164	Rubber	19/0.0117 TC	Neoprene [®] VIII	TC GS TC	0.700	17.8	35.3	52.5	Pulse cable
*191	507-191	25	85.0	279	Rubber	TC braid 0.485	Neoprene [®] VIII	TC GS TC	1.460	37.08	146.9	218.6	CANCELED
192	507-192	12.5	175.0	574.1	Butyl rubber	TC braid GS tube	Rubber	TC, GS, GS	2.165	54.99	-	-	Pulse cable

* Covered by specification Mil-C-17

Neoprene[®] is a trademark of the DuPont de Nemours Co.

California

1959 East Cashdan Street, Rancho Dominguez, CA 90220
(310) 609-1811 • (800) 326-0006 • FAX: (310) 609-1862

E-Mail: salesrd@std-wire.com

Arizona

3120 West Thomas Road, Bldg. #801, Phoenix, AZ 85017
(602) 269-2501 • (800) 325-6478 • FAX: (602) 278-7134

E-Mail: salesphx@std-wire.com



Standard Wire & Cable Co.

RG/U No.	Catalog Number	Nom. Imp. (ohms)			Dielect. Mat.	Size (in.) and Type of Inner Conductor	Jacket	Shield	Overall Diameter (mm)		Weight (lbs / 100ft / kgs / 100m)		Remarks
193	507-193	12.5	159.0	521.7	Silicone rubber	TC braid GW tube	Rubber	TC GS GS	2.165	54.99	-	-	Pulse cable
194	507-194	12.5	159.0	521.7	Silicone rubber	TC braid GW tube	Rubber w/AL armour	TC GS GS	2.01 max.	51.1 max.	-	-	Pulse cable
*195	507-195	95	15.0	49.2	TFE	7/38 SCCS	TFE	S	0.155 max.	3.94 max.	2.0	3.0	Superseded by M17/137-00001
*195A	507-195A	95	15.0	49.2	TFE	7/38 SCCS	TFE	S	0.155 max.	3.94 max.	2.0	3.0	Superseded by M17/137-00001
*196	507-196	50	28.5	93.5	TFE	7/38 SCCS	TFE	S	0.080 max.	2.03 max.	0.6	0.9	Superseded by M17/93-00001
*196A	507-196A	50	28.5	93.5	TFE	7/38 SCCS	TFE	S	0.080 max.	2.03 max.	0.6	0.9	Superseded by M17/93-00001
197	507-197	50	22.0	72.2	PS helix	0.300 BC	None	AL tube	0.875	22.2	50.0	74.4	Semirigid Mil-C-22931/2A
198	507-198	70	16.0	52.5	PS helix	0.114 BC	PE	AL tube	0.600	15.2	15.5	23.1	
199	507-199	70	16.0	52.5	PS helix	0.209 BC	PE	AL tube	1.015	25.78	44.5	66.2	
200	507-200	70	16.0	52.5	PS helix	0.403 BC	PE	AL tube	1.765	44.83	90.0	134	
201	507-201	Rigid waveguide											
202	507-202	Rigid waveguide											
203	507-203	Rigid waveguide											
204	507-204	Rigid waveguide											
205	507-205	Rigid waveguide											
206	507-206	Rigid waveguide											
207	507-207	Rigid waveguide											
208	507-208	Rigid waveguide				19/0.038 S							
*209	507-209	50	26.5	86.9	Air space TFE	19/0.0378 SC	Silicone rubber & FG	2 S	0.750 max.	19.1 max.	43.2	64.3	CANCELED
*210	507-210	93	14.5	47.6	Air space TFE	0.0253 BC	FG-V	S	0.242	6.15	5.0	7.4	Superseded by M17/97 - RG210
*211	507-211	50	29.0	95.1	TFE	0.190 BC	FG-V	BC	0.730	18.5	51.6	76.8	Superseded by M17/72 - RG211
*211A	507-211A	50	29.4	96.5	TFE	0.190 BC	FG-V	BC	0.730	18.5	45.0	67.0	Superseded by M17/72 - RG211
*212	507-212	50	29.4	96.5	PE	0.0556 SC	PVC-IIA	2 S	0.332	8.43	8.3	12.4	Superseded by M17/73 - RG212
*213	507-213	50	30.8	101	PE	7/0.0296 BC	PVC-IIA	BC	0.405	10.3	9.9	14.7	Superseded by M17/74 - RG213
*214	507-214	50	30.8	101	PE	7/0.0296 SC	PVC-IIA	2 S	0.425	10.8	12.6	18.8	Superseded by M17/75 - RG214
*215	507-215	50	30.8	101	PE	7/0.0296 BC	PVC-IIA w/ armor	BC	0.475	12.1	16.0	23.8	Superseded by M17/74 - RG215
*216	507-216	75	20.6	67.6	PE	7/27 TC	PVC-IIA	2 BC	0.425	10.8	11.4	17.0	Superseded by M17/77 - RG216
*217	507-217	50	30.8	101	PE	0.106 BC	PVC-IIA	2 BC	0.545	13.8	22.5	33.5	Superseded by M17/78 - RG217
*218	507-218	50	30.8	101	PE	0.195 BC	PVC-IIA	BC	0.870	22.1	57.5	85.6	Superseded by M17/79 - RG218
*219	507-219	50	30.8	101	PE	0.195 BC	PVC-IIA w/ armor	BC	0.945 max.	24.00 max.	63.9	95.1	Superseded by M17/79 - RG219
*220	507-220	50	30.8	101	PE	0.260 BC	PVC-IIA	BC	1.120	28.45	72.0	107	Formerly RG19A/U Superseded by M17/81-00001
*221	507-221	50	30.8	101	PE	0.260 BC	PVC-IIA w/ armor	BC	1.195	30.35	78.6	117	Formerly RG20A/U Superseded by M17/81-00002

* Covered by specification Mil-C-17

California

1959 East Cashdan Street, Rancho Dominguez, CA 90220
 (310) 609-1811 • (800) 326-0006 • FAX: (310) 609-1862
 E-Mail: salesrd@std-wire.com

Arizona

3120 West Thomas Road, Bldg. #801, Phoenix, AZ 85017
 (602) 269-2501 • (800) 325-6478 • FAX: (602) 278-7134
 E-Mail: salesphx@std-wire.com



Standard Wire & Cable Co.

RG/U No.	Catalog Number	Nom. Imp. (ohms)	Cap. pF per (ft) (m)		Dielect. Mat.	Size (in.) and Type of Inner Conductor	Jacket	Shield	Overall Diameter (in) (mm)		Weight (lbs / (kgs / 100ft) (100m))		Remarks
*222	507-222	50	30.8	101.0	PE	0.0556 resistance	PVC-IIA	2 S	0.332	8.43	8.0	12	Formerly RG21A/U Superseded by M17/162-00001
*223	507-223	50	30.8	101.0	PE	0.035 S	PVC-IIA	2 S	0.212	5.38	3.6	5.4	Superseded by M17/84 - RG223
*224	507-224	50	30.8	101.0	PE	0.106 BC	PVC-IIA w/ armor	2 BC	0.615 max.	15.6 max.	23.0	34.2	Formerly RG74A/U Superseded by M17/165-00002
*225	507-225	50	29.4	96.5	TFE	7/0.0312 S	FG-V	2 S	0.430	10.9	18.0	26.8	Superseded by M17/127 - RG393
*226	507-226	50	29.4	96.5	Taped TFE	19/0.0254 S	FG-V	2 BC	0.500	12.7	44.5	66.2	Superseded by M17/87-00001
*227	507-227	50	29.4	96.5	TFE	7/0.0312 S	FG-V w/ armor	2 S	0.490 max.	12.4 max.	19.8	29.5	Superseded by M17/86-00002
*228	507-228	50	29.4	96.5	TFE	0.190 BC	FG-V w/ armor	BC	0.795 max.	20.2 max.	68.2	101.5	Superseded by M17/161-00002
*228A	507-228A	50	29.4	96.5	TFE	0.190 BC	FG-V w/ armor	BC	0.795 max.	20.2 max.	68.2	101.5	Formerly RG118A/U Superseded by M17/161-00002
229	507-229	50	29.4	96.5	TFE	7/20 S	FG-V	S	0.460	11.7	14.4	21.4	Superseded by M17/65 - RG166
*230	507-230	25	100.0	328.1	Rubber	37/21 TC	Rubber-IV	TC GS GS	0.740	18.8	-	-	Triaxial pulse cable
231	507-231	50	25.0	82.0	PE foam	0.162 BC tube	None	Al tube	0.500	12.7	15.2	22.6	Mil-C-23806/1A
231A	507-231A	50	25.0	82.0	PE foam	0.162 BC	None	Al tube	0.500	12.7	15.2	22.6	Mil-C-23806/1B
232	507-232	50	22.0	72.2	PE helix	0.300 BC	PE-III A	Al tube	1.015	25.78	58.0	86.3	Semirigid Mil-C-22931/2A
233	507-233	50	22.0	72.2	PS helix	BC tube	PE-III A	Al tube	1.765	44.83	108.0	160.7	Semirigid Mil-C-22931/3A
234	507-234	50	22.0	72.2	PS helix	BC tube	PE-III A	Al tube	3.295	83.69	311.0	462.8	Semirigid Mil-C-22931/4A
*235	507-235	50	29.5	96.8	TFE tape	7/21 S	Silicone rubber	2 S	0.470 max.	11.9 max.	16.0	23.8	Superseded by M17/168-00001
236	507-236	50	24.0	78.7	PS helix	0.162 BC	None	Al tube	0.500	12.7	16.5	24.6	Semirigid Mil-C-22931/1A
237	507-237	50	24.0	78.7	PS helix	0.162 BC	PE-III A	Al tube	0.600	15.2	20.0	29.8	Semirigid Mil-C-22931/1A
238	507-238												CANCELED same as RG197/U
239	507-239												CANCELED same as RG232/U
240	507-240	50	22.0	72.2	PS helix	BC tube	None	Al tube	1.625	41.28	93.0	138.4	Semirigid Mil-C-22931/3A
241	507-241												CANCELED same as RG233/U
242	507-242	50	22.0	72.2	PS helix	BC tube	None	Al tube	3.125	79.38	270.0	401.8	Semirigid Mil-C-22931/4A
243	507-243												CANCELED same as RG234/U
244	507-244	75	15.5	50.9	PS helix	0.102 BC	None	Al tube	0.500	12.7	11.8	17.6	Semirigid Mil-C-22931/1A
245	507-245	75	15.5	50.9	PS helix	0.102 BC	PE-III A	Al tube	0.600	15.2	15.3	22.8	Semirigid Mil-C-22931/1A
246	507-246	75	15.5	50.9	PS helix	0.188 BC	None	Al tube	0.875	22.2	34.3	51.0	Semirigid Mil-C-22931/2A
247	507-247	75	15.5	50.9	PS helix	0.188 BC	PE-III A	Al tube	1.015	25.78	42.3	62.9	Semirigid Mil-C-22931/2A
248	507-248	75	15.0	49.2	PS helix	0.370 BC	None	Al tube	1.625	41.28	94.8	141	Semirigid Mil-C-22931/3A
249	507-249	75	15.0	49.2	PS helix	0.370 BC	PE-III A	Al tube	1.765	44.83	109.8	163.4	Semirigid Mil-C-22931/3A
250	507-250	75	15.0	49.2	PS helix	0.732 BC	None	Al tube	3.125	79.38	239.5	356.4	Semirigid Mil-C-22931/4A

* Covered by specification Mil-C-17

California

1959 East Cashdan Street, Rancho Dominguez, CA 90220
 (310) 609-1811 • (800) 326-0006 • FAX: (310) 609-1862
 E-Mail: salesrd@std-wire.com

Arizona

3120 West Thomas Road, Bldg. #801, Phoenix, AZ 85017
 (602) 269-2501 • (800) 325-6478 • FAX: (602) 278-7134
 E-Mail: salesphx@std-wire.com



Standard Wire & Cable Co.

RG/U No.	Catalog Number	Nom. Imp. (ohms)		Cap. pF per (ft) (m)	Dielect. Mat.	Size (in.) and Type of Inner Conductor	Jacket	Shield	Overall Diameter (in) (mm)		Weight (lbs / (kgs / 100ft) 100m)		Remarks
251	507-251	75	15.0	49.2	PS helix	0.732 BC	PE-III A	Al tube	3.295	83.69	280.5	417.4	Semirigid Mil-C-22931/4A
252	507-252	75	24.4	80.1	PE tube	0.167 BC	None	Al tube	0.530	13.5	17.5	26.0	Semirigid Mil-C-22931/1A
253	507-253	75	24.4	80.1	PE tube	0.167 BC	PE	Al tube	0.635 max.	16.1 max.	22.5	33.5	Semirigid Mil-C-22931/1A
254	507-254	50	24.4	80.1	PE tube	0.311 BC	PE	Al tube	1.100 max.	27.94 max.	65.5	97.5	Semirigid Mil-C-22931/2A
255	507-255	50	24.4	80.1	PE tube	0.311 BC	None	Al tube	0.953	24.2	55.5	82.6	Semirigid Mil-C-22931/2A
256	507-256	50	23.5	77.1	TFE tube	S tube	None	Al tube	0.953	24.2	55.0	81.8	
257	507-257	50	24.4	80.1	PS tube	BC tube	None	Al tube	1.786	45.4	120.0	179	Semirigid Mil-C-22931/3A
258	507-258	50	24.4	80.1	PE tube	BC tube	PE	Al tube	1.936 max.	49.17 max.	138.0	205	Semirigid Mil-C-22931/3A
259	507-259	50	23.5	77.1	TFE tube	0.115 BC	None	Al tube	0.390	9.91	10.0	14.9	
260	507-260	50	23.5	77.1	PE tube	0.115 BC	PE-III A	Al tube	0.450	11.4	14.0	20.8	
261	507-261	50	23.5	77.1	PE tube	BC tube	None	Al tube	3.370	85.60	-	-	CANCELED
262	507-262	50	23.5	77.1	PE tube	BC tube	PE	Al tube	3.520	89.41	-	-	CANCELED
263	507-263	50	21.5	70.5	Air space TFE	0.172 BC	None	Al tube	0.500	12.7	17.0	25.3	
264	507-264	40	38.0	125	PE	4 x 19/27 BC	PVC-II A	2 BC 2 TC	0.750	19.1	33.6	50.0	Quad cable
264A	507-264A	40	38.0	125	PE	4 x 19/27 BC	PU	2 BC 2 TC	0.750	19.1	32.7	48.7	Quad cable
264B	507-264B	40	42.0 max.	138 max.	PE	4 x 19/27 BC	PU	2 BC 2 TC	0.750	19.1	-	-	Mil-C-23020A
264C	507-264C	40	42.0 max.	138 max.	PE	2 x 13 BC 2 x 13 TC	PU	2 BC 2 TC	0.750	19.1	32.7	48.7	Mil-C-23020/4
265	507-265	50	22.3	73.2	PS helix	BC tube	PE-III A	CCS tube	2.070	52.6	-	-	Mil-C-22931/7
*266	507-266	1530	53.0	174	PE	0.144 BC helix	PVC-I	BC	0.400	10.2	12.0	17.9	Delay line
267	507-267	50	22.2	72.8	PS helix	BC tube	PE-III	CCS tube	1.190	30.2	-	-	Mil-C-22931/6
268	507-268	50	23.0	75.5	PS helix	0.160 BC	None	BC tube	0.500	12.7	23.4	34.8	Mil-C-22931/5
269	507-269	50	22.2	72.8	PS helix	BC tube	None	BC tube	1.005	25.5	42.1	62.7	Mil-C-22931/6A
270	507-270	50	22.3	73.2	PS helix	BC tube	None	BC tube	1.830	46.5	87.5	130.2	Mil-C-22931/7A
271	507-271	Waveguide											
272	507-272	Waveguide											
273	507-273	Waveguide											
274	507-274	Waveguide											
275	507-275	Waveguide											
276	507-276	Waveguide											
277	507-277	Waveguide											
278	507-278	Waveguide											

* Covered by specification Mil-C-17

California

1959 East Cashdan Street, Rancho Dominguez, CA 90220
 (310) 609-1811 • (800) 326-0006 • FAX: (310) 609-1862
 E-Mail: salesrd@std-wire.com

Arizona

3120 West Thomas Road, Bldg. #801, Phoenix, AZ 85017
 (602) 269-2501 • (800) 325-6478 • FAX: (602) 278-7134
 E-Mail: salesphx@std-wire.com



Standard Wire & Cable Co.

RG/U No.	Catalog Number	Nom. Imp. (ohms)	Cap. pF per (ft) (m)		Dielect. Mat.	Size (in.) and Type of Inner Conductor	Jacket	Shield	Overall Diameter (in) (mm)		Weight (lbs / 100ft) (kgs / 100m)		Remarks
*279	507-279	75	17.0	55.8	Air space TFE	19/36 SCCS	FG-V	S	0.145	3.68	12.5	18.6	
*280	507-280	50	25.4	83.3	Taped TFE	0.1144 BC	FEP-IX	2 S	0.480	12.2	20.0	29.8	
281	507-281	50	25.4	83.3	Taped TFE	19/0.0378 S	SR & braid	2 S	0.750	19.1	40.0	59.5	
282	507-282	54.6	28.2	92.5	Irradiated PE	0.0253 S	FEP	2 S	0.200	5.08	3.1	4.6	
283	507-283	46	50.0	164	Rubber	19/0.177 S	Rubber-IV	2 S	0.475 max.	12.1 max.	14.2	21.1	
284A	507-284A	75	15.0	49.2	PE helix	0.220 BC	None	BC tube	1.005	25.53	41.0	61.0	
285A	507-285A	100	13.0	42.7	TFE helix	0.1140 BC	None	BC tube	1.005	25.53	43.0	64.0	
286	507-286	75	15.1	49.5	PE helix	BC tube	None	BC tube	1.830	46.48	72.0	107	
287	507-287	100	13.5	44.3	PE helix	0.197 BC	None	BC tube	1.830	46.48	75.0	112	
288	507-288	50	21.6	70.9	PE helix	BC tube	None	CCS tube	3.750	95.25	300.0	446.4	
289	507-289	75	14.7	48.2	PE helix	CCS tube	None	CCS tube	3.750	95.25	300.0	446.4	
290	507-290	Waveguide											
291	507-291	Waveguide											
292	507-292	75	15.1	49.5	PE helix	BC tube	PE FC	BC tube	1.830	46.48	104.0	154.8	
293	507-293	50	30.8	101	PE	0.106 BC	PE-III A	S	0.545	13.8	16.0	23.8	Mil-C-23020 A
293A	507-293A	50	30.8	101	PE	0.106 BC	PE-III A	S	0.545	13.8	16.0	23.8	Mil-C-23020/2
294	507-294	95	16.3	53.5	PE	0.0808 BC 0.0808 TC	PE-III A	TC	0.630	16.0	20.5	30.5	Twinaxial
294A	507-294A	95	16.3	53.5	PE	0.0808 BC 0.0808 TC	PE-III A	S	0.630	16.0	20.5	30.5	Twinaxial for submarine use
295	507-295	50	30.8	101	PE	0.195 BC	PE-III A	S	0.895	22.7	42.0	62.5	Mil-C-23020/3
*296	507-296	50	36.4	119	Silicone rubber	37/0.0336 S	Neoprene®	S	1.190	30.23	-	-	
297	507-297	50	21.4	70.2	TFE helix	BC tube	None	BC tube	1.005	25.53	-	-	Mil-C-22667 A
298	507-298	-	-	-	PE	7/24 CCS	PE foam	None	0.650	16.5	9.0	13	Same as RG126/U with FEP jacket
*301	507-301	50	29.4	96.5	TFE	7/0.0203 HR	FEP-IX	HR	0.245	6.22	6.8	10	Superseded by M17/109 - RG301
*302	507-302	75	19.5	64.0	TFE	0.025 SCCS	FEP-IX	S	0.206 max.	5.23 max.	4.0	6.0	Superseded by M17/109 - RG302
*303	507-303	50	29.4	96.5	TFE	0.039 SCCS	FEP-IX	S	0.170	4.32	3.0	4.5	Swept superseded by M17/111 Unswept superseded by M17/170-00001
*304	507-304	50	29.4	96.5	TFE	0.059 SCCS	FEP-IX	2 S	0.280	7.11	4.5	6.7	Superseded by M17/112 - RG304
305	507-305	75	19.5	64.0	FEP	BC tube	PE-III A	BC tube	1.990	50.55	-	-	Similar to RG298/U
306A	507-306A	75	16.9	55.4	PE foam	0.173 BC	PE-III A	Al tube	1.015	25.78	54.5	81.1	Mil-C-23806/2A
*307A	507-307A	75	16.7	54.8	PE foam	19/0.0058 S	PE-III A	2 S	0.270 max.	6.86 max.	8.0	12	Superseded by M17/116 - RG307
*316	507-316	50	29.4	96.5	TFE	7/0.0067 SCCS	FEP-IX	S	0.098	2.49	1.2	1.8	Same as RG188/U with FEP jacket. Swept superseded by M17/113 - RG316 Unswept superseded by M17/172-00001

* Covered by specification Mil-C-17

Neoprene® is a trademark of the DuPont de Nemours Co.

California

1959 East Cashdan Street, Rancho Dominguez, CA 90220
(310) 609-1811 • (800) 326-0006 • FAX: (310) 609-1862
E-Mail: salesrd@std-wire.com

Arizona

3120 West Thomas Road, Bldg. #801, Phoenix, AZ 85017
(602) 269-2501 • (800) 325-6478 • FAX: (602) 278-7134
E-Mail: salesphx@std-wire.com



Standard Wire & Cable Co.

RG/U No.	Catalog Number	Nom. Imp. (ohms)	Cap. pF per (ft) (m)		Dielect. Mat.	Size (in.) and Type of Inner Conductor	Jacket	Shield	Overall Diameter (in) (mm)		Weight (lbs / 100ft) (kgs / 100m)		Remarks
317	507-317	95	15.4	50.5	FEP	2 cond. 7/0.029 BC	Neoprene®	TC	0.710	18.0	-	-	Mil-C-23020/5A
318	507-318	50	22.2	72.8	PE helix	BC tube O.D. 0.3580 I.D. 0.2870	PE-III A	BC tube	1.100	27.94	53.0	78.9	Mil-C-22931/6A
319	507-319	50	22.3	73.2	SS PS	BC tube O.D. 0.6880 I.D. 0.5880	PE-III A	BC tube	1.970	50.04	104.0	154.8	Mil-C-22931/7A
321	507-321	50	21.7	71.2	SS PE	BC tube	None	BC tube	2.850	72.39	121.0	180.1	
322	507-322	50	21.7	71.2	SS PE	BC tube	PE FC	BC tube	3.040	77.22	178.0	264.9	
323	507-323	50	25.6	84.0	PE foam	BC tube	PE FC	BC tube	1.060	26.92	42.0	62.5	
324	507-324	50	25.6	84.0	PE foam	BC tube	None	BC tube	0.980	24.9	32.0	47.6	
325	507-325	50	26.3	86.3	PE spline	19/0.0200 SCCA	PU	2 SC strip	0.465 max.	11.8 max.	10.0	14.9	Low loss
326	507-326	50	26.3	86.3	PE spline	19/0.0400 SCCA	PU	2 SC strip	0.779 max.	19.8 max.	24.0	35.7	Low loss
327	507-327	50	26.3	86.3	PE spline	19/0.0640 SCCA	PU	2 SC strip	1.18 max.	30.0 max.	55.0	81.8	Low loss
*328	507-328	25	85.0	279	Rubber	TC braid	Neoprene®	TC GS TC	1.460	37.08	160.0	238.1	Superseded by M17/124 - RG328
*329	507-329	50	50.0	164	Rubber	19/0.0117 TC	Neoprene®	TC GS TC	0.700	17.8	38.0	56.6	Superseded by M17/125 - RG329
330	507-330	50	25.0	82.0	PE foam	SC	None	SC	0.242	6.1	-	-	
331	507-331	50	25.0	82.0	PE foam	0.162 BC	PE-III A	Al tube	0.625	15.9	18.7	27.8	Mil-C-23806/1A
332	507-332	50	25.0	82.0	PE foam	0.288 BC	None	Al tube	0.875	22.2	48.0	71.4	Mil-C-23806/2A
333	507-333	50	25.0	82.0	PE foam	0.288 BC	PE-III A	Al tube	1.052 max.	26.72 max.	54.5	81.1	Mil-C 23806/2A
334	507-334	75	17.0	55.8	PE foam	0.098 BC	None	Al tube	0.500	12.7	15.2	22.6	Mil-C-23806/1A
335	507-335	75	17.0	55.8	PE foam	0.098 BC	PE-III A	Al tube	0.625	15.9	18.7	27.8	Mil-C-23806/1A
336	507-336	75	16.5	54.1	PE foam	0.173 BC	None	Al tube	0.875	22.2	48.0	71.4	Mil-C-23806/1A
360	507-360	50	25.0	82.0	PE foam	0.243 BC	PE-III A	Al tube	0.825	21.0	39.8	59.2	Mil-C-23806/3A
366	507-366	50	26.6	87.3	PE foam	0.160 BC	PE-III A	BC tube	0.620	15.7	-	-	
367	507-367	50	21.7	71.2	PE helix	BC tube	PE-III A	BC tube	5.200	132.1	45.9	68.3	
369	507-369	50	23.5	77.1	PE tubes	0.177 BC	PE-III A	Al tube	0.470	11.9	14.0	20.8	
370	507-370	50	24.0	78.7	PE tubes	0.177 BC	None	Al tube	0.390	9.91	10.0	14.9	
373	507-373	-	-	-	PE	0.0508 BC	PE foam	None	0.650	16.5	-	-	Mil-C-28751 (EC) buoyant cable
374	507-374	-	-	-	PE	0.0285 BC	PE foam	None	0.650	16.5	9.7	14	Mil-C-24301 buoyant cable
376	507-376	50	26.0	85.3	PE foam	0.312 BC tube	PE-III A	Al tube	1.060	26.92	39.0	58.0	
377	507-377	50	24.0	78.7	TFE tubes	0.165 S tube	None	Al tube	0.530	13.5	17.0	25.3	

* Covered by specification Mil-C-17

Neoprene® is a trademark of the DuPont de Nemours Co.

California

1959 East Cashdan Street, Rancho Dominguez, CA 90220
 (310) 609-1811 • (800) 326-0006 • FAX: (310) 609-1862
 E-Mail: salesrd@std-wire.com

Arizona

3120 West Thomas Road, Bldg. #801, Phoenix, AZ 85017
 (602) 269-2501 • (800) 325-6478 • FAX: (602) 278-7134
 E-Mail: salesphx@std-wire.com



Standard Wire & Cable Co.

RG/U No.	Catalog Number	Nom. Imp. (ohms)	Cap. pF per		Dielect. Mat.	Size (in.) and Type of Inner Conductor	Jacket	Shield	Overall Diameter		Weight		Remarks
			(ft)	(m)					(in)	(mm)	(lbs / 100ft)	(kgs / 100m)	
378	507-378	50	22.1	72.5	PE helix	BC tube	PE-III A	Al tube	2.000	50.80	62.0	92.3	Semirigid Mil-C-22931/13
382	507-382	Rigid Line											
383	507-383	100	-	-	PE	2 cond. 0.0403	PE foam	None	0.650	16.5	-	-	Twisted pair, high strength alloy conductors
384	507-384	50	30.8	101	PE	0.16 BC	PE foam	Flat BC	0.650	16.5	-	-	Mil-C-28726 (EC) buoyant cable
385	507-385	50	25.4	83.3	SS TFE	0.153 S	Optional	Al tube	0.660	16.8	17.8	26.5	Low loss
386	507-386	-	-	-	PE	0.0508 CCS	PE foam	None	0.650	16.5	-	-	
388	507-388	50	30.8	101	PE	0.1020 BC	PE-III A	S	0.545	13.8	-	-	
389	507-389	50	22.8	74.8	PE	0.250 BC AL	PE-III A	2S	0.875	22.2	36.6	54.5	Low loss, replaces RG189/U
*391	507-391	72	23.0	75.5	C PE & PE	7/26 TC	PVC-II A	TC	0.405	10.3	9.2	14	Low noise Superseded by M17/126 - RG391
*392	507-392	72	23.0	75.5	C PE & PE	7/26 TC	PVC-II A	TC	0.475	12.1	11.4	17.0	RG391/U with armor Superseded by M17/126 - RG392
*393	507-393	50	29.4	96.5	TFE	7/0.0312 S	FEP-IX	2 S	0.390	9.91	16.5	24.6	Swept superseded by M17/127 - RG393 Unswept superseded by M17/174-00001
*400	507-400	50	29.4	96.5	TFE	19/0.0077 S	FEP-IX	2 S	0.195	4.95	5.0	7.4	Swept superseded by M17/128 - RG400 Unswept superseded by M17/175-00001
*401	507-401	50	29.4	96.5	TFE	0.0641 S	None	BC tube	0.250	6.35	8.1	12	Superseded by M17/129 - RG401
*402	507-402	50	29.4	96.5	TFE	0.0360 SCCS	None	BC tube	0.141	3.58	3.2	4.8	Superseded by M17/130 - RG402
*403	507-403	50	29.4	96.5	TFE	7/38 SCCS	FEP-IX	2 S	0.104	2.64	0.750	1.12	Triaxial Superseded by M17/131 - RG403
*404	507-404	50	31.5	103	TFE	7/38 SCCS	FEP-IX	S	0.075 max.	0.191 max.	0.54	0.80	Low noise Superseded by M17/132 - RG404
*405	507-405	50	29.4	96.5	TFE	0.0201 SCCS	None	BC tube	0.086	2.18	1.53	2.28	Semirigid Superseded by M17/133 - RG405

* Covered by specification Mil-C-17

California

1959 East Cashdan Street, Rancho Dominguez, CA 90220
 (310) 609-1811 • (800) 326-0006 • FAX: (310) 609-1862
 E-Mail: salesrd@std-wire.com

Arizona

3120 West Thomas Road, Bldg. #801, Phoenix, AZ 85017
 (602) 269-2501 • (800) 325-6478 • FAX: (602) 278-7134
 E-Mail: salesphx@std-wire.com



Standard Wire & Cable Co.

COAX CABLE CROSS-REFERENCE

MIL-C No.	RG No.	Catalog No.
M17/6	RG 12	507-12
M17/6	RG 12A	507-12A
M17/15	RG 22	507-22
M17/15	RG 22A	507-22A
M17/15	RG 22B	507-22B
M17/15	RG 111	507-111
M17/16	RG 23	507-23
M17/16	RG 23A	507-23A
M17/16	RG 24	507-24
M17/16	RG 24A	507-24A
M17/19	RG 25	507-25
M17/19	RG 25A	507-25A
M17/21	RG 26	507-26
M17/21	RG 26A	507-26A
M17/22	RG 27	507-27
M17/22	RG 27A	507-27A
M17/23	RG 28	507-28
M17/23	RG 28A	507-28A
M17/23	RG 28B	507-28B
M17/24	RG 34	507-34
M17/24	RG 34A	507-34A
M17/24	RG 34B	507-34B
M17/28	RG 58	507-58
M17/28	RG 58A	507-58A
M17/28	RG 58B	507-58B
M17/28	RG 58C	507-58C
M17/29	RG 59	507-59
M17/29	RG 59A	507-59A
M17/29	RG 59B	507-59B
M17/30	RG 62	507-62
M17/30	RG 62A	507-62A
M17/30	RG 62B	507-62B
M17/30	RG 62C	507-62C
M17/31	RG 63	507-63
M17/31	RG 63A	507-63A
M17/31	RG 63B	507-63B
M17/31	RG 79	507-79
M17/31	RG 79A	507-79A
M17/31	RG 79B	507-79B
M17/33	RG 64	507-64
M17/33	RG 64A	507-64A
M17/34	RG 65	507-65
M17/34	RG 65A	507-65A
M17/45	RG 108	507-108
M17/45	RG 108A	507-108A
M17/47	RG 114	507-114
M17/47	RG 114A	507-114A
M17/52	RG 119	507-119
M17/52	RG 120	507-120

MIL-C No.	RG No.	Catalog No.
M17/54	RG 122	507-122
M17/56	RG 130	507-130
M17/56	RG 131	507-131
M17/60	RG 142	507-142
M17/60	RG 142A	507-142A
M17/60	RG 142B	507-142B
M17/62	RG 144	507-144
M17/64	RG 35	507-35
M17/64	RG 164	507-164
M17/65	RG 165	507-165
M17/65	RG 166	507-166
M17/67	RG 177	507-177
M17/72	RG 211	507-211
M17/72	RG 211A	507-211A
M17/73	RG 212	507-212
M17/74	RG 213	507-213
M17/74	RG 215	507-215
M17/75	RG 214	507-214
M17/75	RG 365	507-365
M17/77	RG 216	507-216
M17/78	RG 217	507-217
M17/79	RG 218	507-218
M17/79	RG 219	507-219
M17/84	RG 223	507-223
M17/90	RG 71	507-71
M17/90	RG 71A	507-71A
M17/90	RG 71B	507-71B
M17/92	RG 115	507-115
M17/93	RG 178	507-178
M17/93	RG 178A	507-178A
M17/93	RG 178B	507-178B
M17/94	RG 179	507-179
M17/94	RG 179A	507-179A
M17/94	RG 179B	507-179B
M17/95	RG 180	507-180
M17/97	RG 210	507-210
M17/100	RG 133	507-133
M17/100	RG 133A	507-133A
M17/109	RG 301	507-301
M17/110	RG 302	507-302
M17/111	RG 303	507-303
M17/112	RG 304	507-304
M17/113	RG 316	507-316
M17/116	RG 307	507-307
M17/116	RG 307A	507-307A
M17/119	RG 174	507-174
M17/124	RG 328	507-328
M17/125	RG 329	507-329
M17/126	RG 391	507-391

California

1959 East Cashdan Street, Rancho Dominguez, CA 90220
 (310) 609-1811 • (800) 326-0006 • FAX: (310) 609-1862
 E-Mail: salesrd@std-wire.com

Arizona

3120 West Thomas Road, Bldg. #801, Phoenix, AZ 85017
 (602) 269-2501 • (800) 325-6478 • FAX: (602) 278-7134
 E-Mail: salesphx@std-wire.com



Standard Wire & Cable Co.

MIL-C No.	RG No.	Catalog No.
M17/126	RG 392	507-392
M17/127	RG 393	507-393
M17/128	RG 400	507-400
M17/129	RG 401	507-401
M17/130	RG 402	507-402
M17/131	RG 403	507-403
M17/132	RG 404	507-404
M17/133	RG 405	507-405

RG No.	MIL-C No.	Catalog No.
RG 6	M17/2	507-6
RG 6A	M17/2	507-6A
RG 11	M17/6	507-11
RG 11A	M17/6	507-11A
RG 12	M17/6	507-12
RG 12A	M17/6	507-12A
RG 22	M17/15	507-22
RG 22A	M17/15	507-22A
RG 22B	M17/15	507-22B
RG 23	M17/16	507-23
RG 23A	M17/16	507-23A
RG 24	M17/16	507-24
RG 24A	M17/16	507-24A
RG 25	M17/19	507-25
RG 25A	M17/19	507-25A
RG 26	M17/21	507-26
RG 26A	M17/21	507-26A
RG 27	M17/22	507-27
RG 27A	M17/22	507-27A
RG 28	M17/23	507-28
RG 28A	M17/23	507-28A
RG 28B	M17/23	507-28B
RG 34	M17/24	507-34
RG 34A	M17/24	507-34A
RG 34B	M17/24	507-34B
RG 35	M17/64	507-35
RG 58	M17/28	507-58
RG 58A	M17/28	507-58A
RG 58B	M17/28	507-58B
RG 58C	M17/28	507-58C
RG 59	M17/29	507-59
RG 59A	M17/29	507-59A
RG 59B	M17/29	507-59B
RG 62	M17/30	507-62
RG 62A	M17/30	507-62A
RG 62B	M17/30	507-62B
RG 63	M17/31	507-63
RG 63A	M17/31	507-63A
RG 63B	M17/31	507-63B
RG 64	M17/33	507-64
RG 64A	M17/33	507-64A
RG 65	M17/34	507-65
RG 65A	M17/34	507-65A

RG No.	MIL-C No.	Catalog No.
RG 71	M17/90	507-71
RG 71A	M17/90	507-71A
RG 71B	M17/90	507-71B
RG 79	M17/31	507-79
RG 79A	M17/31	507-79A
RG 79B	M17/31	507-79B
RG 108	M17/45	507-108
RG 108A	M17/45	507-108A
RG 111	M17/15	507-111
RG 114	M17/47	507-114
RG 114A	M17/47	507-114A
RG 115	M17/92	507-115
RG 119	M17/52	507-119
RG 120	M17/52	507-120
RG 122	M17/54	507-122
RG 130	M17/56	507-130
RG 131	M17/56	507-131
RG 133	M17/100	507-133
RG 133A	M17/100	507-133A
RG 142	M17/60	507-142
RG 142A	M17/60	507-142A
RG 142B	M17/60	507-142B
RG 144	M17/62	507-144
RG 164	M17/64	507-164
RG 165	M17/65	507-165
RG 166	M17/65	507-166
RG 174	M17/119	507-174
RG 177	M17/67	507-177
RG 178	M17/93	507-178
RG 178A	M17/93	507-178A
RG 178B	M17/93	507-178B
RG 179	M17/94	507-179
RG 179A	M17/94	507-179A
RG 179B	M17/94	507-179B
RG 180	M17/95	507-180
RG 210	M17/97	507-210
RG 211	M17/72	507-211
RG 211A	M17/72	507-211A
RG 212	M17/73	507-212
RG 213	M17/74	507-213
RG 214	M17/75	507-214
RG 215	M17/74	507-215
RG 216	M17/77	507-216
RG 217	M17/78	507-217
RG 218	M17/79	507-218
RG 219	M17/79	507-219
RG 223	M17/84	507-223
RG 301	M17/109	507-301

California

1959 East Cashdan Street, Rancho Dominguez, CA 90220
 (310) 609-1811 • (800) 326-0006 • FAX: (310) 609-1862

E-Mail: salesrd@std-wire.com

Arizona

3120 West Thomas Road, Bldg. #801, Phoenix, AZ 85017
 (602) 269-2501 • (800) 325-6478 • FAX: (602) 278-7134

E-Mail: salesphx@std-wire.com



Standard Wire & Cable Co.

Attenuation - M17/

M17/ Number	Resist- ance (ohms)	Maximum Attenuation dB/100 ft. at the Following Frequencies						Max. Power (Watts @ 400 MHz)	Max. Frequency (GHz)
		100 MHz	400 MHz	1 GHz	3 GHz	5 GHz	10 GHz		
M17/28	50	6.5	17.0	28.0	-	-	-	90	1.0
M17/52	50	2.1	4.4	7.6	13.0	-	-	600	1.0
M17/54	50	8.2	18.0	30.0	-	-	-	62	1.0
M17/60	50	5.5	11.7	19.0	35.0	48.0	-	1,100	12.4
M17/65	50	2.1	4.6	8.0	15.0	-	-	2,700	3.0
M17/67	50	1.0	2.6	5.0	15.0	25.0	-	1,600	5.6
M17/72	50	0.85	2.3	4.5	-	-	-	11,000	1.0
M17/73	50	3.0	6.5	12.0	24.0	34.0	54.0	350	11.0
M17/74	50	2.3	4.8	9.0	-	-	-	320	1.0
M17/75	50	2.6	6.8	12.0	25.0	35.0	56.0	330	11.0
M17/78	50	1.6	3.7	7.0	14.0	-	-	470	3.0
M17/79	50	1.0	2.8	5.0	-	-	-	1,200	1.0
M17/81	50	-	2.3	-	-	-	-	-	0.4
M17/84	50	6.5	12.0	21.0	40.0	54.0	84.0	86	12.4
M17/86	50	-	5.0	-	-	-	-	-	0.4
M17/87	50	-	3.8	-	-	-	-	-	0.4
M17/92	50	2.5	5.7	9.8	23.0	34.0	58.0	2,600	12.4
M17/93	50	16.0	33.0	52.0	94.0	-	-	110	3.0
M17/111	50	3.9	8.6	15.0	28.0	-	-	1,100	3.0
M17/112	50	2.7	6.4	11.1	22.0	30.0	-	1,450	12.4
M17/113	50	10.5	21.0	38.0	58.0	-	-	210	3.0
M17/119	50	10.0	25.0	45.0	-	-	-	26	1.0
M17/127	50	2.4	5.0	8.8	18.0	24.0	37.0	1,100	12.4
M17/128	50	4.5	10.5	17.0	38.0	50.0	78.0	1,050	12.4
M17/129	50	-	4.5	7.5	16.0	22.0	33.0	1,900	19.3
M17/130	50	-	7.1	12.0	21.0	29.0	45.0	660	34.2
M17/131	50	13.0	29.0	50.0	94.0	120.0	150.0	95	12.4
M17/133	50	-	13.5	22.0	37.0	52.0	80.0	210	40.0
M17/134	50	6.0	15.0	26.0	60.0	-	-	60	3.0
M17/135	50	2.5	6.0	11.0	22.0	-	-	350	3.0
M17/138	50	10.0	20.0	32.0	55.0	-	-	210	3.0
M17/151	50	-	25.0	40.0	70.0	90.0	130.0	52	40.0
M17/152	50	11.5	24.0	40.0	75.0	110.0	170.0	210	12.4
M17/153	50	11.0	23.0	40.0	75.0	110.0	170.0	26	12.4
M17/154	50	-	37.0	60.0	100.0	140.0	190.0	16	40.0

California

1959 East Cashdan Street, Rancho Dominguez, CA 90220
 (310) 609-1811 • (800) 326-0006 • FAX: (310) 609-1862
 E-Mail: salesrd@std-wire.com

Arizona

3120 West Thomas Road, Bldg. #801, Phoenix, AZ 85017
 (602) 269-2501 • (800) 325-6478 • FAX: (602) 278-7134
 E-Mail: salesphx@std-wire.com



Standard Wire & Cable Co.

M17/ Number	Resist- ance (ohms)	Maximum Attenuation dB/100 ft. at the Following Frequencies						Max. Power (Watts @ 400 MHz)	Max. Frequency (GHz)
		100 MHz	400 MHz	1 GHz	3 GHz	5 GHz	10 GHz		
M17/155	50	-	17.0	-	-	-	-	-	0.4
M17/156	50	-	4.5	-	-	-	-	-	0.4
M17/157	50	-	18.0	-	-	-	-	-	0.4
M17/158	50	-	9.5	-	-	-	-	-	0.4
M17/159	50	-	4.6	-	-	-	-	-	0.4
M17/160	50	-	2.7	-	-	-	-	-	0.4
M17/161	50	-	2.0	-	-	-	-	-	0.4
M17/162	50	-	6.5	-	-	-	-	-	0.4
M17/163	50	-	4.7	-	-	-	-	-	0.4
M17/164	50	-	4.6	-	-	-	-	-	0.4
M17/165	50	-	3.8	-	-	-	-	-	0.4
M17/167	50	-	11.5	-	-	-	-	-	0.4
M17/168	50	-	5.2	-	-	-	-	-	0.4
M17/169	50	-	29.0	-	-	-	-	-	0.4
M17/170	50	-	8.6	-	-	-	-	-	0.4
M17/171	50	-	6.4	-	-	-	-	-	0.4
M17/172	50	-	21.0	-	-	-	-	-	0.4
M17/173	50	-	25.0	-	-	-	-	-	0.4
M17/174	50	-	5.0	-	-	-	-	-	0.4
M17/175	50	-	10.5	-	-	-	-	-	0.4
M17/183	50	6.5	17.0	28.0	-	-	-	60	1.0
M17/187	50	8.0	18.0	30.0	-	-	-	62	1.0
M17/188	50	2.8	6.2	11.0	21.0	30.0	45.0	400	11.0
M17/189	50	2.2	4.7	9.0	-	-	-	320	1.0
M17/190	50	2.4	5.5	9.6	19.0	26.0	40.0	400	11.0
M17/192	50	1.6	4.0	7.0	15.0	-	-	400	3.0
M17/193	50	1.0	2.8	5.0	-	-	-	1,200	1.0
M17/194	50	6.5	12.0	20.0	40.0	55.0	84.0	86	12.4
M17/196	50	10.0	25.0	45.0	-	-	-	26	1.0
M17/208	50	6.5	17.0	28.0	-	-	-	90	1.0
M17/2	75	-	6.5	-	23.0	-	-	210	3.0
M17/6	75	-	5.2	9.4	-	-	-	290	1.0
M17/24	75	-	3.8	-	-	-	-	680	1.0
M17/29	75	-	9.0	16.0	-	-	-	130	1.0
M17/62	75	-	4.5	-	18.0	-	-	-	3.0
M17/64	75	-	2.8	6.0	-	-	-	-	1.0

California

1959 East Cashdan Street, Rancho Dominguez, CA 90220
 (310) 609-1811 • (800) 326-0006 • FAX: (310) 609-1862
 E-Mail: salesrd@std-wire.com

Arizona

3120 West Thomas Road, Bldg. #801, Phoenix, AZ 85017
 (602) 269-2501 • (800) 325-6478 • FAX: (602) 278-7134
 E-Mail: salesphx@std-wire.com



Standard Wire & Cable Co.

M17/ Number	Resist- ance (ohms)	Maximum Attenuation dB/100 ft. at the Following Frequencies						Max. Power (Watts @ 400 MHz)	Max. Frequency (GHz)
		100 MHz	400 MHz	1 GHz	3 GHz	5 GHz	10 GHz		
M17/77	75	-	6.5	-	23.0	-	-	210	3.0
M17/94	75	-	15.8	-	-	-	-	-	0.4
M17/110	75	-	8.0	-	25.0	-	-	1,700	3.0
M17/116	75	-	7.5	-	-	-	-	130	1.0
M17/126	75	-	15.0	-	-	-	-	-	1.0
M17/136	75	-	21.0	-	-	-	-	1,400	3.0
M17/179	75	-	21.0	-	-	-	-	1,400	3.0
M17/180	75	-	6.5	-	23.0	-	-	210	3.0
M17/181	75	-	5.2	9.4	-	-	-	290	1.0
M17/184	75	-	9.0	16.0	-	-	-	130	1.0
M17/191	75	-	6.5	-	23.0	-	-	210	3.0
M17/45	78	-	-	-	-	-	-	-	0.01
M17/30	93	-	8.0	13.0	-	-	-	9	1.0
M17/90	93	-	5.2	-	-	-	-	-	0.4
M17/97	93	-	5.0	-	-	-	-	-	0.4
M17/15	95	4.0	-	-	-	-	-	-	0.2
M17/56	95	-	5.2	-	-	-	-	-	0.2
M17/95	95	-	10.4	-	-	-	-	-	0.4
M17/100	95	-	4.5	-	-	-	-	-	0.4
M17/137	95	-	10.4	-	-	-	-	-	0.4
M17/139	95	8.8	17.0	29.0	-	-	-	-	3.0
M17/177	95	-	10.4	-	-	-	-	-	0.4
M17/178	95	-	10.4	-	-	-	-	-	0.4
M17/16	125	-	5.2	-	-	-	-	-	0.4
M17/31	125	-	3.4	-	-	-	-	-	0.4
M17/47	185	-	6.7	-	-	-	-	-	0.4

California

1959 East Cashdan Street, Rancho Dominguez, CA 90220
 (310) 609-1811 • (800) 326-0006 • FAX: (310) 609-1862
 E-Mail: salesrd@std-wire.com

Arizona

3120 West Thomas Road, Bldg. #801, Phoenix, AZ 85017
 (602) 269-2501 • (800) 325-6478 • FAX: (602) 278-7134
 E-Mail: salesphx@std-wire.com



Attenuation - RG

RG Number	Resistance (ohms)	Maximum Attenuation dB/100 ft. at the Following Frequencies						Max. Power (Watts @ 400 MHz)	Max. Frequency (GHz)
		100 MHz	400 MHz	1 GHz	3 GHz	5 GHz	10 GHz		
RG192	12.5	-	-	-	-	-	-	-	-
RG193	12.5	-	-	-	-	-	-	-	-
RG194	12.5	-	-	-	-	-	-	-	-
RG191	25	-	-	-	-	-	-	-	-
RG230	25	-	-	-	-	-	-	-	-
RG328	25	-	-	-	-	-	-	-	-
RG264B	40	-	12.0	-	-	-	-	-	-
RG264C	40	-	12.0	-	-	-	-	-	-
RG283	46	-	5.0	-	16.0	-	-	-	-
RG25	48	-	-	-	-	-	-	-	-
RG25A	48	-	-	-	-	-	-	-	-
RG26	48	-	-	-	-	-	-	-	-
RG26A	48	-	-	-	-	-	-	-	-
RG27A	48	-	-	-	-	-	-	-	-
RG28B	48	-	-	-	-	-	-	-	-
RG64	48	-	-	-	-	-	-	-	-
RG64A	48	-	-	-	-	-	-	-	-
RG88	48	-	-	-	-	-	-	-	-
RG88A	48	-	-	-	-	-	-	-	-
RG5A	50	2.6	5.5	9.1	17.8	25.0	-	-	-
RG5B	50	2.6	5.5	9.1	17.8	25.0	-	-	-
RG9	50	2.0	4.25	7.3	15.5	23.0	36.0	-	-
RG9A	50	2.1	5.0	9.0	18.0	25.0	38.0	-	-
RG9B	50	2.1	5.0	9.0	18.0	25.0	38.0	-	-
RG55A	50	4.8	10.3	16.7	30.7	46.0	130.0	-	-
RG58A	50	6.0	13.5	24.0	54.0	83.0	247.0	-	-
RG58C	50	6.0	13.5	24.0	54.0	83.0	247.0	-	-
RG74	50	1.4	3.1	5.5	12.4	19.0	51.0	-	-
RG81	50	-	5.5	-	-	-	-	-	-
RG82	50	-	3.5	-	-	-	-	-	-
RG87A	50	2.07	4.45	7.60	15.0	21.5	36.5	-	-
RG94	50	2.2	5.0	9.0	20.0	-	-	-	-
RG94A	50	-	3.5	-	-	-	-	-	-
RG115	50	2.05	4.4	7.3	14.0	20.0	33.0	-	-

California

1959 East Cashdan Street, Rancho Dominguez, CA 90220
 (310) 609-1811 • (800) 326-0006 • FAX: (310) 609-1862
 E-Mail: salesrd@std-wire.com

Arizona

3120 West Thomas Road, Bldg. #801, Phoenix, AZ 85017
 (602) 269-2501 • (800) 325-6478 • FAX: (602) 278-7134
 E-Mail: salesphx@std-wire.com



Standard Wire & Cable Co.

RG Number	Resistance (ohms)	Maximum Attenuation dB/100 ft. at the Following Frequencies						Max. Power (Watts @ 400 MHz)	Max. Frequency (GHz)
		100 MHz	400 MHz	1 GHz	3 GHz	5 GHz	10 GHz		
RG115A	50	2.05	4.4	7.3	14.0	20.0	33.0	-	-
RG116	50	2.07	4.45	7.60	15.0	21.5	36.5	-	-
RG117	50	0.90	2.4	3.55	7.6	12.0	38.0	-	-
RG117A	50	-	2.3	-	-	-	-	-	-
RG118	50	0.90	2.4	3.55	7.6	12.0	38.0	-	-
RG118A	50	-	2.3	-	-	-	-	-	-
RG119	50	1.5	3.25	5.6	11.8	17.8	56.0	-	-
RG120	50	1.5	3.25	5.6	11.8	17.8	56.0	-	-
RG122	50	7.0	16.5	29.0	57.0	-	-	-	-
RG126	50	-	-	70.0	116.0	-	-	-	-
RG141	50	3.85	8.5	13.8	27.0	39.0	70.0	-	-
RG141A	50	3.85	8.5	13.8	27.0	39.0	70.0	-	-
RG142	50	3.85	8.5	13.8	27.0	39.0	70.0	-	-
RG142A	50	3.85	8.5	13.8	27.0	39.0	70.0	-	-
RG142B	50	3.85	8.5	13.8	27.0	39.0	70.0	-	-
RG143	50	2.8	5.8	9.6	18.2	25.5	42.0	-	-
RG143A	50	2.8	5.8	9.6	18.2	25.5	42.0	-	-
RG156	50	-	-	-	-	-	-	-	-
RG157	50	-	-	-	-	-	-	-	-
RG158	50	-	-	-	-	-	-	-	-
RG165	50	2.07	4.45	7.60	15.0	21.5	36.5	-	-
RG166	50	2.07	4.45	7.60	15.0	21.5	36.5	-	-
RG174	50	8.9	17.4	30.0	64.0	99.0	190.0	-	-
RG177	50	0.95	2.4	4.4	9.5	15.3	-	-	-
RG178	50	13.8	28.0	46.0	76.0	114.0	170.0	-	-
RG178A	50	13.8	28.0	46.0	76.0	114.0	170.0	-	-
RG178B	50	-	29.0	-	-	-	-	-	-
RG188	50	11.4	16.7	31.0	60.0	82.0	136.0	-	-
RG188A	50	11.4	16.7	31.0	60.0	82.0	136.0	-	-
RG190	50	-	-	-	-	-	-	-	-
RG196	50	13.8	28.0	46.0	76.0	114.0	170.0	-	-
RG197	50	-	1.0	-	3.4	-	-	2,800	6.6
RG209	50	-	2.5	-	9.4	-	-	-	-
RG211	50	0.90	2.4	3.55	7.6	12.0	38.0	-	-
RG211A	50	-	2.3	-	10.0	-	-	-	-

California

1959 East Cashdan Street, Rancho Dominguez, CA 90220
 (310) 609-1811 • (800) 326-0006 • FAX: (310) 609-1862
 E-Mail: salesrd@std-wire.com

Arizona

3120 West Thomas Road, Bldg. #801, Phoenix, AZ 85017
 (602) 269-2501 • (800) 325-6478 • FAX: (602) 278-7134
 E-Mail: salesphx@std-wire.com



Standard Wire & Cable Co.

RG Number	Resistance (ohms)	Maximum Attenuation dB/100 ft. at the Following Frequencies						Max. Power (Watts @ 400 MHz)	Max. Frequency (GHz)
		100 MHz	400 MHz	1 GHz	3 GHz	5 GHz	10 GHz		
RG212	50	2.6	5.5	9.1	17.8	25.0	-	-	-
RG213	50	2.0	4.6	8.0	16.5	27.0	-	-	-
RG214	50	2.1	5.0	9.0	18.0	25.0	38.0	-	-
RG215	50	2.0	4.6	8.0	16.5	27.0	-	-	-
RG217	50	1.4	3.1	5.5	12.4	19.0	51.0	-	-
RG218	50	0.95	2.4	4.4	9.5	15.3	-	-	-
RG219	50	0.95	2.4	4.4	9.5	15.3	-	-	-
RG220	50	0.69	1.85	3.6	7.7	-	-	-	-
RG221	50	0.69	1.85	3.6	7.7	-	-	-	-
RG222	50	13.0	26.0	43.0	85.0	-	-	-	-
RG223	50	4.8	10.3	16.7	30.7	46.0	130.0	-	-
RG224	50	1.4	3.1	5.5	12.4	19.0	51.0	-	-
RG225	50	2.07	4.45	7.60	15.0	21.5	36.5	-	-
RG226	50	-	3.5	-	-	-	-	-	-
RG227	50	2.07	4.45	7.60	15.0	21.5	36.5	-	-
RG228	50	0.90	2.4	3.55	7.6	12.0	38.0	-	-
RG228A	50	-	2.3	-	10.0	-	-	-	-
RG231	50	-	2.3	4.2	-	-	-	-	-
RG231A	50	0.8	1.8	3.3	6.8	10.0	-	1,100	10.0
RG232	50	-	1.0	-	3.4	-	-	2,800	6.6
RG233	50	0.25	0.5	0.9	2.0	-	-	-	-
RG234	50	0.13	0.29	0.5	-	-	-	-	-
RG235	50	2.05	4.4	7.3	14.0	20.0	33.0	-	-
RG236	50	0.19	1.8	3.0	6.0	8.0	14.0	1,200	10.9
RG237	50	0.19	1.8	3.0	6.0	8.0	14.0	-	-
RG240	50	0.25	0.5	0.9	2.0	-	-	-	-
RG242	50	0.13	0.29	0.5	-	-	-	-	-
RG245	50	0.8	1.7	2.7	4.5	6.0	-	-	-
RG252	50	0.9	1.8	2.8	5.0	7.7	10.2	1,200	10.2
RG253	50	0.9	1.8	2.8	5.0	7.7	10.2	1,200	10.2
RG254	50	-	1.0	1.5	3.3	-	-	2,800	5.6
RG255	50	-	1.0	1.5	3.3	-	-	2,800	5.6
RG257	50	0.22	0.45	0.8	1.8	-	-	-	-
RG258	50	0.22	0.45	0.8	1.8	-	-	-	-
RG265	50	0.18	0.58	1.0	-	-	-	-	-

California

1959 East Cashdan Street, Rancho Dominguez, CA 90220
 (310) 609-1811 • (800) 326-0006 • FAX: (310) 609-1862
 E-Mail: salesrd@std-wire.com

Arizona

3120 West Thomas Road, Bldg. #801, Phoenix, AZ 85017
 (602) 269-2501 • (800) 325-6478 • FAX: (602) 278-7134
 E-Mail: salesphx@std-wire.com



Standard Wire & Cable Co.

RG Number	Resistance (ohms)	Maximum Attenuation dB/100 ft. at the Following Frequencies						Max. Power (Watts @ 400 MHz)	Max. Frequency (GHz)
		100 MHz	400 MHz	1 GHz	3 GHz	5 GHz	10 GHz		
RG267	50	0.47	1.0	1.7	3.0	-	-	-	-
RG268	50	0.89	1.8	2.8	5.0	7.2	12.5	-	-
RG269	50	0.40	0.85	1.5	2.6	-	-	-	-
RG269A	50	-	0.9	-	2.5	-	-	3,000	6.0
RG270	50	0.22	0.45	0.8	1.8	-	-	-	-
RG280	50	-	3.5	6.0	11.0	-	-	-	-
RG281	50	1.2	2.5	4.1	8.0	-	-	-	-
RG293A	50	-	4.0	-	15.0	-	-	-	-
RG295	50	-	3.0	-	12.5	-	-	-	-
RG296	50	-	11.0	-	-	-	-	-	-
RG301	50	-	-	70.0	116.0	-	-	-	-
RG303	50	3.85	8.5	13.8	27.0	39.0	70.0	-	-
RG304	50	2.8	5.8	9.6	18.2	25.5	42.0	-	-
RG316	50	11.4	16.7	31.0	60.0	82.0	136.0	-	-
RG318	50	-	0.9	-	2.5	-	-	3,000	6.0
RG319	50	0.22	0.45	0.8	1.8	-	-	-	-
RG325	50	2.2	4.6	7.6	14.4	19.6	30.5	340	12.4
RG326	50	1.1	2.4	4.1	8.3	11.7	-	720	7.8
RG327	50	0.8	1.7	3.0	6.5	9.4	-	1,400	5.0
RG329	50	-	-	-	-	-	-	-	-
RG331	50	0.8	1.8	3.3	6.8	10.0	-	1,100	10.0
RG332	50	0.6	1.3	2.3	4.9	7.2	-	2,100	5.7
RG333	50	0.5	1.0	2.2	4.8	7.0	-	2,100	5.6
RG360	50	0.6	1.5	2.8	6.0	9.0	-	1,600	6.7
RG366	50	0.9	1.9	3.3	6.7	9.6	-	1,000	9.0
RG369	50	1.3	2.7	4.5	8.6	12.0	22.5	670	14.6
RG370	50	1.3	2.7	4.5	8.6	12.0	22.5	670	14.6
RG376	50	0.5	1.2	2.2	4.8	-	-	2,100	4.8
RG385	50	1.2	2.5	4.3	8.6	12.0	19.6	N/A	10.6
RG389	50	0.8	1.8	3.2	6.6	9.4	-	1,500	7.6
RG8	52	2.0	4.6	8.0	16.5	27.0	-	-	-
RG8A	52	2.0	4.6	8.0	16.5	27.0	-	-	-
RG10	52	2.0	4.6	8.0	16.5	27.0	-	-	-
RG10A	52	2.0	4.6	8.0	16.5	27.0	-	-	-
RG14	52	1.4	3.1	5.5	12.4	19.0	51.0	-	-

California

1959 East Cashdan Street, Rancho Dominguez, CA 90220
 (310) 609-1811 • (800) 326-0006 • FAX: (310) 609-1862
 E-Mail: salesrd@std-wire.com

Arizona

3120 West Thomas Road, Bldg. #801, Phoenix, AZ 85017
 (602) 269-2501 • (800) 325-6478 • FAX: (602) 278-7134
 E-Mail: salesphx@std-wire.com



Standard Wire & Cable Co.

RG Number	Resistance (ohms)	Maximum Attenuation dB/100 ft. at the Following Frequencies						Max. Power (Watts @ 400 MHz)	Max. Frequency (GHz)
		100 MHz	400 MHz	1 GHz	3 GHz	5 GHz	10 GHz		
RG14A	52	1.4	3.1	5.5	12.4	19.0	51.0	-	-
RG17	52	0.95	2.4	4.4	9.5	15.3	-	-	-
RG17A	52	0.95	2.4	4.4	9.5	15.3	-	-	-
RG18	52	0.95	2.4	4.4	9.5	15.3	-	-	-
RG18A	52	0.95	2.4	4.4	9.5	15.3	-	-	-
RG19	52	0.69	1.85	3.6	7.7	-	-	-	-
RG19A	52	0.69	1.85	3.6	7.7	-	-	-	-
RG20	52	0.69	1.85	3.6	7.7	-	-	-	-
RG20A	52	0.69	1.85	3.6	7.7	-	-	-	-
RG74A	52	1.4	3.1	5.5	12.4	19.0	51.0	-	-
RG5	52.5	2.7	6.4	11.3	22.0	30.0	43.0	-	-
RG21	53	13.0	26.0	43.0	85.0	-	-	-	-
RG21A	53	13.0	26.0	43.0	85.0	-	-	-	-
RG55B	53	4.8	10.3	16.7	30.7	46.0	130.0	-	-
RG29	53.5	4.4	9.6	16.2	30.0	-	-	-	-
RG55	53.5	4.8	10.3	16.7	30.7	46.0	130.0	-	-
RG58	53.5	4.6	10.4	17.8	37.5	60.0	-	-	-
RG58B	53.5	4.6	10.4	17.8	37.5	60.0	-	-	-
RG54	58	3.2	6.8	11.5	25.0	-	-	-	-
RG54A	58	3.2	6.8	11.5	25.0	-	-	-	-
RG179	70	10.0	16.0	24.0	44.0	64.0	139.0	-	-
RG34	71	1.4	3.28	5.85	16.0	-	-	-	-
RG34A	71	1.4	3.28	5.85	16.0	-	-	-	-
RG35	71	0.85	1.95	3.5	8.6	15.5	18.0	-	-
RG35A	71	0.85	1.95	3.5	8.6	15.5	18.0	-	-
RG59	73	3.4	7.0	12.0	26.5	42.0	-	-	-
RG13	74	2.3	4.75	7.8	16.5	26.5	-	-	-
RG13A	74	2.3	4.75	7.8	16.5	26.5	-	-	-
RG6	75	2.7	6.4	11.3	22.0	30.0	43.0	-	-
RG6A	75	2.7	6.4	11.3	22.0	30.0	43.0	-	-
RG11	75	2.3	4.75	7.8	16.5	26.5	-	-	-
RG11A	75	2.3	4.75	7.8	16.5	26.5	-	-	-
RG12	75	2.3	4.75	7.8	16.5	26.5	-	-	-
RG12A	75	2.3	4.75	7.8	16.5	26.5	-	-	-
RG15	75	1.8	4.0	6.9	-	-	-	-	1.0

California

1959 East Cashdan Street, Rancho Dominguez, CA 90220
 (310) 609-1811 • (800) 326-0006 • FAX: (310) 609-1862
 E-Mail: salesrd@std-wire.com

Arizona

3120 West Thomas Road, Bldg. #801, Phoenix, AZ 85017
 (602) 269-2501 • (800) 325-6478 • FAX: (602) 278-7134
 E-Mail: salesphx@std-wire.com



Standard Wire & Cable Co.

RG Number	Resistance (ohms)	Maximum Attenuation dB/100 ft. at the Following Frequencies						Max. Power (Watts @ 400 MHz)	Max. Frequency (GHz)
		100 MHz	400 MHz	1 GHz	3 GHz	5 GHz	10 GHz		
RG34B	75	1.4	3.28	5.85	16.0	-	-	-	-
RG35B	75	0.85	1.95	3.5	8.6	15.5	18.0	-	-
RG36	75	0.8	2.0	3.7	-	-	-	-	1.0
RG59A	75	3.4	7.0	12.0	26.5	42.0	-	-	-
RG59B	75	3.4	7.0	12.0	26.5	42.0	-	-	-
RG84A	75	-	2.8	-	-	-	-	-	-
RG85A	75	-	2.8	-	-	-	-	-	-
RG140	75	4.0	8.4	13.8	25.9	-	-	-	3.0
RG144	75	1.8	3.9	6.9	14.8	-	-	-	-
RG149	75	-	8.5	-	-	-	-	-	-
RG150	75	-	8.5	-	-	-	-	-	-
RG161	75	9.3	18.8	30.1	53.3	-	-	-	3.0
RG164	75	0.85	1.95	3.5	8.6	15.5	18.0	-	-
RG179A	75	10.0	16.0	24.0	44.0	64.0	139.0	-	-
RG179B	75	-	21.0	-	-	-	-	-	-
RG187	75	10.0	16.0	24.0	44.0	64.0	139.0	-	-
RG187A	75	9.4	19.1	30.8	55.2	-	-	-	3.0
RG216	75	2.3	4.75	7.8	16.5	26.5	-	-	-
RG244	75	0.8	1.7	2.7	4.5	6.0	-	-	-
RG279	75	5.2	10.8	17.6	32.5	-	-	-	3.0
RG302	75	3.3	6.9	12.8	26.0	-	-	-	-
RG306A	75	0.52	1.3	2.20	4.8	7.0	-	1,700	6.0
RG307A	75	-	7.5	-	-	-	-	-	-
RG334	75	0.9	2.0	3.5	7.0	9.9	16.2	-	11.0
RG335	75	0.9	2.0	3.5	7.0	9.9	16.2	-	11.0
RG336	75	0.5	1.2	2.2	4.0	7.0	-	-	-
RG108	78	-	16.8	-	-	-	-	-	-
RG108A	78	-	16.8	-	-	-	-	-	-
RG62	93	2.7	5.3	8.7	18.5	30.0	83.0	-	-
RG62A	93	2.7	5.3	8.7	18.5	30.0	83.0	-	-
RG62B	93	-	7.3	-	-	-	-	-	-
RG62C	93	-	8.0	-	-	-	-	-	-
RG71	93	2.7	5.3	8.7	18.5	30.0	83.0	-	-
RG71A	93	2.7	5.3	8.7	18.5	30.0	83.0	-	-
RG71B	93	2.7	5.3	8.7	18.5	30.0	83.0	-	-

California

1959 East Cashdan Street, Rancho Dominguez, CA 90220
 (310) 609-1811 • (800) 326-0006 • FAX: (310) 609-1862
 E-Mail: salesrd@std-wire.com

Arizona

3120 West Thomas Road, Bldg. #801, Phoenix, AZ 85017
 (602) 269-2501 • (800) 325-6478 • FAX: (602) 278-7134
 E-Mail: salesphx@std-wire.com



Standard Wire & Cable Co.

RG Number	Resistance (ohms)	Maximum Attenuation dB/100 ft. at the Following Frequencies						Max. Power (Watts @ 400 MHz)	Max. Frequency (GHz)
		100 MHz	400 MHz	1 GHz	3 GHz	5 GHz	10 GHz		
RG180	93	5.7	10.8	17.0	35.0	50.0	88.0	-	-
RG210	93	-	7.0	-	-	-	-	-	-
RG7	95	2.4	5.2	-	-	-	-	-	-
RG22	95	4.6	8.7	-	-	-	-	-	-
RG22B	95	3.9	7.7	12.0	25.0	-	-	-	-
RG57	95	-	6.0	-	-	-	-	-	-
RG57A	95	-	6.0	-	-	-	-	-	-
RG111	95	3.9	7.7	12.0	25.0	-	-	-	-
RG111A	95	3.9	7.7	12.0	25.0	-	-	-	-
RG130	95	-	6.0	-	-	-	-	-	-
RG131	95	-	6.0	-	-	-	-	-	-
RG133A	95	-	5.7	-	-	-	-	-	-
RG180A	95	5.7	10.8	17.0	35.0	50.0	88.0	-	-
RG180B	95	-	17.0	-	-	-	-	-	-
RG195	95	6.6	13.3	22.5	46.0	-	-	-	-
RG195A	95	6.6	13.3	22.5	46.0	-	-	-	-
RG294	95	-	10.0	-	-	-	-	-	-
RG294A	95	-	10.0	-	-	-	-	-	-
RG317	95	-	8.0	-	-	-	-	-	-
RG23A	125	-	5.2 ea.	-	-	-	-	-	-
RG24A	125	-	5.2 ea.	-	-	-	-	-	-
RG63	125	1.99	4.0	6.4	12.2	-	-	-	-
RG63B	125	1.99	4.0	6.4	12.2	-	-	-	-
RG79	125	1.99	4.0	6.4	12.2	-	-	-	-
RG79B	125	1.99	4.0	6.4	12.2	-	-	-	-
RG181	125	-	6.0 ea.	-	-	-	-	-	-
RG125	150	1.6	3.4	5.7	13.4	-	-	-	-
RG114	185	2.9	-	-	-	-	-	-	-
RG114A	185	2.9	-	-	-	-	-	-	-
RG65A	950	-	-	-	-	-	-	-	-
RG65A	950	-	-	-	-	-	-	-	-

California

1959 East Cashdan Street, Rancho Dominguez, CA 90220
 (310) 609-1811 • (800) 326-0006 • FAX: (310) 609-1862
 E-Mail: salesrd@std-wire.com

Arizona

3120 West Thomas Road, Bldg. #801, Phoenix, AZ 85017
 (602) 269-2501 • (800) 325-6478 • FAX: (602) 278-7134
 E-Mail: salesphx@std-wire.com



Heat Shrinkable Products

Medium/Heavy Wall Tubing

Military Heavy Wall Mil-I-81765/1
Commercial Medium/Heavy Wall
Telecom
Low Voltage Electrical

Medium & Heavy Wall Tubing, Adhesive
Lined or Unlined

Wrap Around Sleeves

Commercial
Telecom
Low Voltage Electrical

Cable Jacket Repair

Cable End Caps

Wire & Cable MIL-I-81765/1
Telecom

Environmental Covers, Pressurized
Cable Caps, Filled Cable Caps

Transition Boots

MIL-I-81765/1

Cable Harnessing Systems, Lipped/
Non-lipped, Right Angle/Low-Profile

Cable Breakout Boots

Ratio Cable MIL-I-81765/1
DOD-2003-1
Navsea 803-5001027

2-8 Leg Boots, High Ratio Boots

Adhesive and Mastic Tapes

Low temperature tolerant adhesive tapes
Semi cross-linked butyl mastic

Shrink Tubing

MIL-I-23053/1, /4, /5, /6, /8, /13, /16

High-Ratio Grommets

A cable spacer and strain relief for circular mil connectors

Cable Entry Seals*

Navsea 803-500127
MIL-M-214519
MIL-I-81765/1

Straight Thru/Right Angle and Multi-leg

Ratio Tubing*

MIL-I-81765/1
UL®

True 6:1 Ratio, Sealant or Adhesive
Lined

Motor Connection Kits*

Stub or "V" type
600 Volt Motor Connections type

Motor Feeder Sizes 12 AWG through
1,000 MCM

* Not shown

California

1959 East Cashdan Street, Rancho Dominguez, CA 90220
(310) 609-1811 • (800) 326-0006 • FAX: (310) 609-1862
E-Mail: salesrd@std-wire.com

Arizona

3120 West Thomas Road, Bldg. #801, Phoenix, AZ 85017
(602) 269-2501 • (800) 325-6478 • FAX: (602) 278-7134
E-Mail: salesphx@std-wire.com



Standard Wire & Cable Co.

Military Heavy Wall Tubing



Heavy Wall Splice Tubing - Military/Industrial OEM Grade

HHW gives the optimum mechanical protection when used as a jacket or splice cover. Its high abrasion resistant formulation combined with an extra heavy wall eliminates many problems associated with today's jacketed cable. Its feature of a superior expansion to recovery ratio allows transitions in diameter with heavy wall tubing as an added use benefit and high tear resistance. HHW conforms over irregular shapes and surfaces and exceeds MIL-I-81765/1.

COLOR: Red, white, black PUT UP: 12 in. (305 mm) lengths standard, cut lengths available.

Catalog No.	Standard Internal Diameter				Nominal Recovered Wall Thickness	
	Minimum Expanded (in)	Minimum Expanded (mm)	Maximum Recovered (in)	Maximum Recovered (mm)	(in)	(mm)
HHW-5	0.50	12.7	0.120	3.05	0.155	3.94
HHW-7	0.75	19.1	0.250	6.35	0.155	3.94
HHW-10	1.00	25.4	0.375	9.53	0.155	3.94
HHW-15	1.50	38.1	0.500	12.7	0.155	3.94
HHW-20	2.00	50.8	0.750	19.1	0.155	3.94

Available with sealant.

Commercial Heavy Wall Tubing



XHTU/A* is a heat shrinkable, cross-linked, heavy wall polyolefin tubing available with or without an adhesive liner.

SHRINK RATIO: 3:1 PUT UP: 5 ft. (1.5 m) lengths standard, cut lengths are available.
OPER. TEMP: -40° C to 135° C.
COLOR: Black. LINING: Adhesive liner melts and flows providing an environmental seal.

CONSTRUCTION: Heavy wall offers increased mechanical protection as well as corrosion and abrasion resistance.

USES: Joint and cable repair in power and telecom markets. Ideally suited for aerial, underground, and direct burial applications.

Catalog No.	Minimum Expansion		Maximum Recovered**		Nominal Recovered Wall**	
	(in)	(mm)	(in)	(mm)	(in)	(mm)
XHTU-12/3	0.480	12.2	0.120	3.05	0.100	2.54
XHTU-19/6	0.756	19.2	0.200	5.08	0.106	2.69
XHTU-30/8	1.200	30.48	0.320	8.13	0.160	4.06
XHTU-45/12	1.700	43.18	0.480	12.2	0.160	4.06
XHTU-52/15	2.000	50.80	0.600	15.2	0.160	4.06
XHTU-72/22	2.830	71.88	0.835	21.2	0.165	4.19
XHTU-92/25	3.620	91.95	1.000	25.40	0.170	4.32
XHTU-120/35	4.725	120.0	1.400	35.56	0.180	4.57

* to designate adhesive insert a "/A" in catalog number. ** Wall thickness does not include adhesive when ordering adhesive lined product.

California

1959 East Cashdan Street, Rancho Dominguez, CA 90220
(310) 609-1811 • (800) 326-0006 • FAX: (310) 609-1862
E-Mail: salesrd@std-wire.com

Arizona

3120 West Thomas Road, Bldg. #801, Phoenix, AZ 85017
(602) 269-2501 • (800) 325-6478 • FAX: (602) 278-7134
E-Mail: salesphx@std-wire.com



Standard Wire & Cable Co.

Commercial Medium Wall Tubing



XMTU/A* is a heat shrinkable, cross-linked, medium wall polyolefin tubing available with or without an adhesive liner.

- SHRINK RATIO: 3:1
 OPER. TEMP: -40° C to 135° C.
 COLOR: Black.
- PUT UP: 5 ft. (1.5 m) lengths standard, cut lengths available.
 LINING: Adhesive liner melts and flows providing an environmental seal.
- CONSTRUCTION: Medium wall offers mechanical protection as well as corrosion and abrasion resistance.
 USES: Joint and cable repair in power and telecom markets, mechanical support and moisture barrier for underground burials.

Catalog No.	Minimum Expansion		Maximum Recovered**		Nominal Recovered Wall**	
	(in)	(mm)	(in)	(mm)	(in)	(mm)
XMTU-12/3	0.500	12.70	0.118	3.00	0.060	1.52
XMTU-22/6	0.866	22.00	0.240	6.10	0.100	2.54
XMTU-27/7	1.060	26.92	0.275	6.99	0.100	2.54
XMTU-34/7	1.350	34.29	0.275	6.99	0.100	2.54
XMTU-40/12	1.574	39.98	0.415	10.5	0.100	2.54
XMTU-56/17	2.200	55.88	0.650	16.5	0.110	2.79
XMTU-71/20	2.835	72.01	0.800	20.3	0.110	2.79
XMTU-92/25	3.620	91.95	1.000	25.40	0.110	2.79
XMTU-120/35	4.720	119.9	1.100	27.94	0.110	2.79

* to designate adhesive insert a "/A" in catalog number. ** Wall thickness does not include adhesive when ordering adhesive lined product.

Wrap Around Sleeves XWSA



- OPER. TEMP: For cables operating up to 125° C and 1 Kv.
 COLOR: Black.
- PUT UP: 5 ft. (1.5 m) lengths standard, cut lengths available.
- CONSTRUCTION: Precoated with a hot melt adhesive that bonds to a wide variety of substrates commonly used in cable manufacturing, ensuring a complete environmental seal against moisture and contaminant ingress. The exterior is coated with a heat sensitive paint which changes color when the appropriate application of heat has been applied.
- USES: A general purpose heat shrinkable wraparound sleeve that provides a quick and simple method for repairing cable jackets.

Catalog No.	Maximum Cable Diameter		Minimum Cable Diameter		Conductor Size AWG / KcMIL
	(in)	(mm)	(in)	(mm)	
XWSA-43/9	1.8	46	0.35	8.9	#2 - 4/0
XWSA-71/15	2.8	71	0.60	15	250 - 500
XWSA-92/25	3.6	91	1.00	25.4	750 - 1,000
XWSA-119/28	4.7	119	1.10	27.9	1,250 - 2,500
XWSA-132/38	5.2	132	1.50	38.1	
XWSA-155/51	6.1	155	2.00	50.8	
XWSA-200/56	8.0	203	2.20	55.9	

California

1959 East Cashdan Street, Rancho Dominguez, CA 90220
(310) 609-1811 • (800) 326-0006 • FAX: (310) 609-1862
E-Mail: salesrd@std-wire.com

Arizona

3120 West Thomas Road, Bldg. #801, Phoenix, AZ 85017
(602) 269-2501 • (800) 325-6478 • FAX: (602) 278-7134
E-Mail: salesphx@std-wire.com



Standard Wire & Cable Co.

Military/Industrial Grade End Caps Heat Shrinkable End Caps With or Without Sealant & Valves

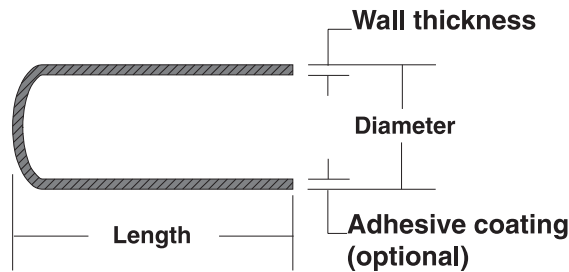

- MATERIAL:** Conforms to MIL-I-81765/1.
- SIZES:** End caps come in sizes to cover cables ranging from 0.37" to 3.5" in diameter.
- RELIABILITY:** Seal moisture out and pressure in on all types of low and medium density polyethylene jacketed cable. A special design combined with a high-grade compound to form an ideal product that withstands the most severe environmental conditions.
- TEMPERATURE:** Cable pressure of 12 psi is maintained throughout thermal conditions ranging from -40° C to 60° C.
- USES:** Commonly used by cable manufacturers and installers of telephone cables, power cables, and jelly filled cables. Can also be used for terminating pipe and conduit.

Catalog No.	Recommended Cable Range		Expanded Minimum Diameter		Recovered Maximum Diameter		Nominal Length		Recovered Wall Thickness		Adhesive Coating	
	(in)	(mm)	(in)	(mm)	(in)	(mm)	(in)	(mm)	(in)	(mm)	(in)	(mm)
080EK025	0.25 - 0.75	6.35 - 19.1	0.80	20.3	0.25	6.35	3.00	76.2	0.140	3.56	0.02	0.51
137EK050	0.50 - 1.35	12.7 - 34.3	1.37	34.8	0.50	12.7	3.50	88.9	0.150	3.81	0.02	0.51
200EK075	0.75 - 2.00	19.1 - 50.8	2.10	53.3	0.75	19.1	3.50	88.9	0.150	3.81	0.02	0.51
380EK150	1.60 - 3.75	40.6 - 95.3	3.80	96.5	1.50	38.1	4.50	114	0.180	4.57	0.02	0.51

California

1959 East Cashdan Street, Rancho Dominguez, CA 90220
 (310) 609-1811 • (800) 326-0006 • FAX: (310) 609-1862
 E-Mail: salesrd@std-wire.com

Arizona

3120 West Thomas Road, Bldg. #801, Phoenix, AZ 85017
 (602) 269-2501 • (800) 325-6478 • FAX: (602) 278-7134
 E-Mail: salesphx@std-wire.com



Standard Wire & Cable Co.

Transition Boot Strain Relief & Boots for Harness Systems

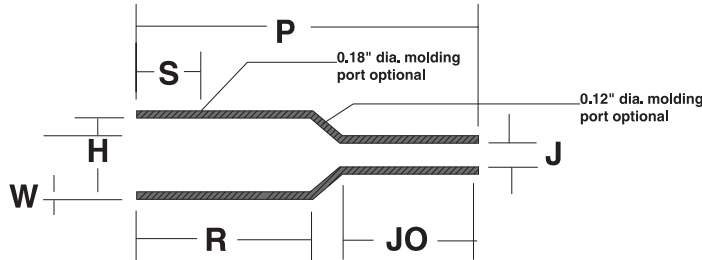
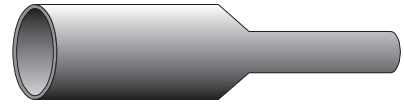

MATERIALS: -30 Conforms to MIL-I-81765/1A, unlined.
 -31 Conforms to MIL-I-81765/1A, lined with standard adhesive.
 -32 Conforms to MIL-I-81765/1A, lined with high performance adhesive.

COLOR: Black.

USES: Heat shrinkable materials are supplied in an expanded form and cover a wide dynamic range, reducing the need to stock a large inventory of sizes. There are 9 sizes of strain relief boots for a range of shell sizes from 6 to 48. Heat shrinkable molded shapes provide mechanical protection and strain relief for connectors and can be used to form breakouts. The combination of heat shrinkable tubings and molded shapes provides an encapsulated wire harness assembly for maximum environmental protection.

Catalog No.		91346	91347	91348	91349	91350	91351	91352	91353	91354	
H	(in)	(min.) ¹	0.65	0.97	1.12	1.22	1.42	1.68	2.04	2.60	3.40
		(max.) ²	0.31	0.38	0.56	0.70	0.84	1.07	1.36	1.72	2.21
	(mm)	(min.) ¹	16.51	24.64	28.45	30.99	36.07	42.67	51.82	66.04	86.36
		(max.) ²	7.87	9.65	14.22	17.78	21.34	27.18	34.54	43.69	56.13
J	(in)	(min.) ¹	0.65	0.97	1.12	1.22	1.42	1.68	2.04	2.60	3.40
		(max.) ²	0.15	0.21	0.26	0.29	0.34	0.37	0.63	0.77	1.06
	(mm)	(min.) ¹	16.51	24.64	28.45	30.99	36.07	42.67	51.82	66.04	86.36
		(max.) ²	3.81	5.33	6.60	7.37	8.64	9.40	16.00	19.56	26.92
P (±20%)	(in) ²	1.00	1.50	2.16	2.63	2.90	3.90	5.13	6.35	8.37	
	(mm) ²	25.40	38.10	54.86	66.80	73.66	99.06	130.30	161.29	212.60	
R (±10%)	(in) ²	0.56	0.86	1.10	1.40	1.63	2.47	2.56	3.55	4.45	
	(mm) ²	14.22	21.84	27.94	35.56	41.40	62.74	65.02	90.17	113.03	
S (±10%)	(in) ²	0.50	0.60	0.75	0.75	0.75	0.75	1.00	1.00	1.00	
	(mm) ²	12.70	15.24	19.05	19.05	19.05	19.05	25.40	25.40	25.40	
JO (±10%)	(in) ²	0.23	0.36	0.51	0.70	0.63	0.71	1.50	1.88	2.45	
	(mm) ²	5.84	9.14	12.95	17.78	16.00	18.03	38.10	47.75	62.23	
W (±20%)	(in) ²	0.05	0.06	0.07	0.07	0.07	0.08	0.13	0.15	0.16	
	(mm) ²	1.27	1.52	1.78	1.78	1.78	2.03	3.30	3.81	4.06	
Weight (±10%)	(lbs)	0.002	0.006	0.008	0.014	0.025	0.040	0.100	0.193	0.367	
	(kgs)	0.001	0.003	0.004	0.006	0.011	0.018	0.045	0.088	0.167	
This Boot Fits	MIL-C-5015 Shell Size	-	8S, 10S	10SL, 12S, 12	14S, 14	16S, 16, 18	20, 22	24, 28	32, 36	40	
	MIL-C-26482 Shell Size	6	8	10	12, 14	16	18, 20	22, 24	-	-	

¹Expanded as supplied
²Unrestricted recovery

California

1959 East Cashdan Street, Rancho Dominguez, CA 90220
 (310) 609-1811 • (800) 326-0006 • FAX: (310) 609-1862
 E-Mail: salesrd@std-wire.com

Arizona

3120 West Thomas Road, Bldg. #801, Phoenix, AZ 85017
 (602) 269-2501 • (800) 325-6478 • FAX: (602) 278-7134
 E-Mail: salesphx@std-wire.com



Standard Wire & Cable Co.

Transition Boot Right Angle

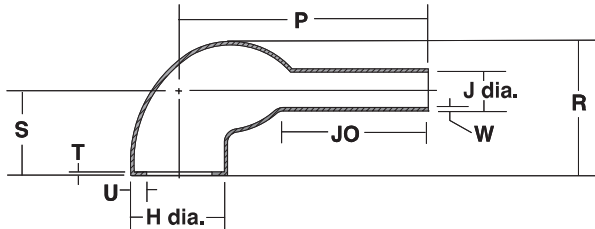
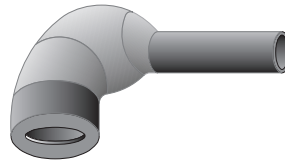

MATERIALS: -30 Conforms to MIL-I-81765/1A, unlined.
 -31 Conforms to MIL-I-81765/1A, lined with standard adhesive.
 -32 Conforms to MIL-I-81765/1A, lined with high performance adhesive.

COLOR: Black.

Catalog No.		913RL48	913RL49	913RL50	913RL51	913RL52	
H	(in)	(min.) ¹	1.12	1.22	1.42	1.68	2.04
		(max.) ²	0.56	0.70	0.88	1.10	1.38
	(mm)	(min.) ¹	28.4	31.0	36.1	42.7	51.8
		(max.) ²	14.2	17.8	22.4	27.9	35.1
J	(in)	(min.) ¹	1.12	1.22	1.42	1.68	2.04
		(max.) ²	0.26	0.28	0.33	0.38	0.62
	(mm)	(min.) ¹	28.4	31.0	36.1	42.7	51.8
		(max.) ²	6.60	7.11	8.38	9.65	15.75
P (±10%)	(in) ²	1.31	1.42	1.70	2.10	3.10	
	(mm) ²	33.3	36.1	43.2	53.3	78.7	
R (±10%)	(in) ²	1.07	1.20	1.40	1.70	2.10	
	(mm) ²	27.2	30.5	35.6	43.2	53.3	
S (±10%)	(in) ²	0.73	0.81	0.90	1.10	1.30	
	(mm) ²	18.5	20.6	22.9	27.9	33.0	
JO (±20%)	(in) ²	0.28	0.34	0.50	0.62	1.00	
	(mm) ²	7.11	8.64	12.7	15.7	25.4	
W (±20%)	(in) ²	0.06	0.07	0.07	0.08	0.13	
	(mm) ²	1.52	1.78	1.78	2.03	3.30	
T (±10%)	(in) ²	0.12	0.12	0.12	0.12	0.12	
	(mm) ²	3.05	3.05	3.05	3.05	3.05	
U (±10%)	(in) ²	0.040	0.040	0.040	0.065	0.065	
	(mm) ²	1.02	1.02	1.02	1.65	1.65	
MS No.		3117-12	3117-13	3117-14	3117-15	3117-16	

¹Expanded as supplied

²Unrestricted recovery

California

1959 East Cashdan Street, Rancho Dominguez, CA 90220
 (310) 609-1811 • (800) 326-0006 • FAX: (310) 609-1862
 E-Mail: salesrd@std-wire.com

Arizona

3120 West Thomas Road, Bldg. #801, Phoenix, AZ 85017
 (602) 269-2501 • (800) 325-6478 • FAX: (602) 278-7134
 E-Mail: salesphx@std-wire.com



Standard Wire & Cable Co.

Transition Boot Low-Profile

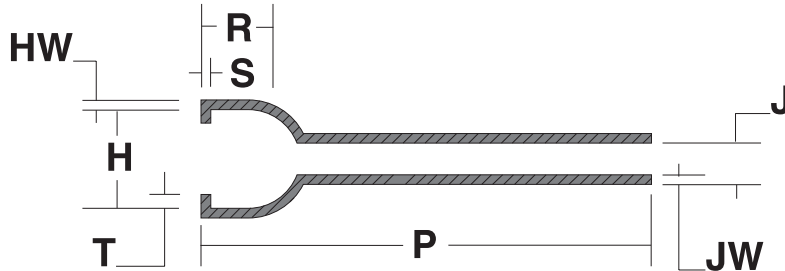

MATERIALS: -30 conforms to MIL-I-81765/1A, unlined.
 -31 conforms to MIL-I-81765/1A, lined with standard adhesive.
 -32 conforms to MIL-I-81765/1A, lined with high performance adhesive.

COLOR: Black.

Catalog No.		913L66	913L67	913L68	913L69	913L70	
H	(in)	(min.) ¹	0.88	1.01	1.16	1.34	1.47
		(max.) ²	0.45	0.59	0.74	0.90	1.16
	(mm)	(min.) ¹	22.4	25.7	29.5	34.0	37.3
		(max.) ²	11.4	15.0	18.8	22.9	29.5
J	(in)	(min.) ¹	0.88	1.01	1.16	1.34	1.47
		(max.) ²	0.25	0.29	0.33	0.38	0.41
	(mm)	(min.) ¹	22.4	25.7	29.5	34.0	37.3
		(max.) ²	6.35	7.37	8.38	9.65	10.4
P (±10%)	(in) ²	4.17	4.77	5.46	6.28	7.00	
	(mm) ²	106	121	139	160	178	
R (±10%)	(in) ²	0.46	0.48	0.48	0.48	0.55	
	(mm) ²	11.7	12.2	12.2	12.2	14.0	
S (Nom)	(in) ²	0.12	0.12	0.12	0.12	0.12	
	(mm) ²	3.05	3.05	3.05	3.05	3.05	
T (±10%)	(in) ²	0.040	0.040	0.040	0.040	0.065	
	(mm) ²	1.02	1.02	1.02	1.02	1.65	
HW (±20%)	(in) ²	0.060	0.060	0.070	0.070	0.080	
	(mm) ²	1.52	1.52	1.78	1.78	2.03	
JW (±20%)	(in) ²	0.045	0.045	0.045	0.045	0.045	
	(mm) ²	1.14	1.14	1.14	1.14	1.14	

¹Expanded as supplied
²Unrestricted recovery

California

1959 East Cashdan Street, Rancho Dominguez, CA 90220
 (310) 609-1811 • (800) 326-0006 • FAX: (310) 609-1862
 E-Mail: salesrd@std-wire.com

Arizona

3120 West Thomas Road, Bldg. #801, Phoenix, AZ 85017
 (602) 269-2501 • (800) 325-6478 • FAX: (602) 278-7134
 E-Mail: salesphx@std-wire.com



Standard Wire & Cable Co.

Transition Boot with Lip

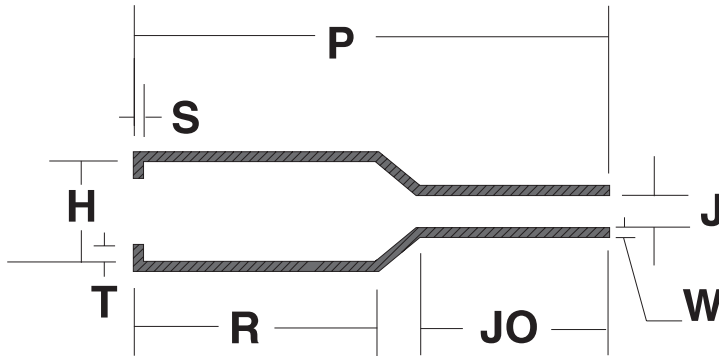
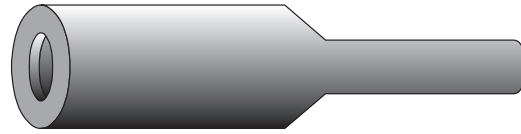

MATERIALS: -30 conforms to MIL-I-81765/1A, unlined.
 -31 conforms to MIL-I-81765/1A, lined with standard adhesive.
 -32 conforms to MIL-I-81765/1A, lined with high performance adhesive.
 COLOR: Black.

Catalog No.		913L46	913L47	913L48	913L49	913L50	913L51	913L52	913L53	913L54	
H	(in)	(min.) ¹	0.65	0.92	1.12	1.22	1.42	1.68	2.04	2.60	3.40
		(max.) ²	0.31	0.41	0.56	0.70	0.88	1.11	1.38	1.75	2.21
	(mm)	(min.) ¹	16.5	23.4	28.4	31.0	36.1	42.7	51.8	66.0	86.4
		(max.) ²	7.87	10.4	14.2	17.8	22.4	28.2	35.1	44.5	56.1
J	(in)	(min.) ¹	0.65	0.92	1.12	1.22	1.42	1.68	2.04	2.60	3.40
		(max.) ²	0.15	0.22	0.26	0.28	0.33	0.39	0.62	0.80	1.06
	(mm)	(min.) ¹	16.5	23.4	28.4	31.0	36.1	42.7	51.8	66.0	86.4
		(max.) ²	3.81	5.59	6.60	7.11	8.38	9.91	15.7	20.3	26.9
P (±10%)	(in) ²	1.00	1.50	2.16	2.63	2.90	3.90	5.13	6.35	8.37	
	(mm) ²	25.4	38.1	54.9	66.8	73.7	99.1	130	161	213	
R (±10%)	(in) ²	0.56	0.92	1.27	1.59	1.73	2.47	3.02	3.55	4.45	
	(mm) ²	14.2	23.4	32.3	40.4	43.9	62.7	76.7	90.2	113	
S (±10%)	(in) ²	0.12	0.12	0.12	0.12	0.12	0.12	0.12	0.12	0.12	
	(mm) ²	3.05	3.05	3.05	3.05	3.05	3.05	3.05	3.05	3.05	
T (±20%)	(in) ²	0.040	0.040	0.040	0.040	0.040	0.065	0.065	0.080	0.080	
	(mm) ²	1.02	1.02	1.02	1.02	1.02	1.65	1.65	2.03	2.03	
JO (±10%)	(in) ²	0.23	0.36	0.51	0.70	0.63	0.71	1.50	1.88	2.45	
	(mm) ²	5.84	9.14	13.0	17.8	16.0	18.0	38.1	47.8	62.2	
W (±20%)	(in) ²	0.05	0.06	0.07	0.07	0.07	0.08	0.13	0.15	0.16	
	(mm) ²	1.27	1.52	1.78	1.78	1.78	2.03	3.30	3.81	4.06	
MIL-C-5015 Adaptors	Rotating	-	-	10SL, 12S	14S	16S, 16, 18	20, 22	24, 28	32, 36	40	
	Solid	-	-	8	10	12, 14	16, 18	20, 22, 24	-	-	
MIL-C-26482 Adaptors	Rotating	-	8	10	12, 14	16, 18	20	22, 24	-	-	
	Solid	-	-	-	-	-	-	-	-	-	

¹Expanded as supplied

²Unrestricted recovery

California

1959 East Cashdan Street, Rancho Dominguez, CA 90220
 (310) 609-1811 • (800) 326-0006 • FAX: (310) 609-1862
 E-Mail: salesrd@std-wire.com

Arizona

3120 West Thomas Road, Bldg. #801, Phoenix, AZ 85017
 (602) 269-2501 • (800) 325-6478 • FAX: (602) 278-7134
 E-Mail: salesphx@std-wire.com





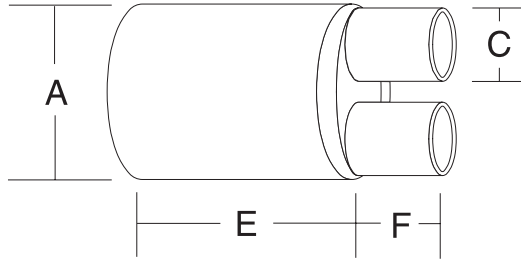
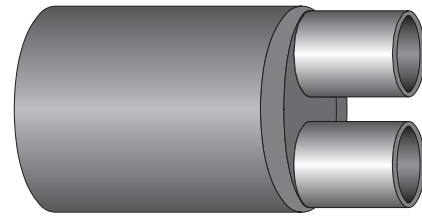

Standard Wire & Cable Co.

Ratio Cable Breakout Boot



MATERIALS: Conform to MIL-I-81765/1.
Designed to meet the requirements of DOD-2003-1.

Boot Style		2 Legs		3 Legs			4 Legs		6 Legs	
										
Catalog No.		91342-12	91342-34	91343-5678	91343-910	91343-11	91344-1213	91344-1415	91344-1617	91346-18
Cable MCM		3-30	50-400	3-100	150-400	500-600	3-23	42-100	100-200	100-200
Combined Navy Part No.		IA62-1-2	IA62-3-4	IA62-5-6-7-8	IA62-9-10	IA62-11	IA62-12-13	IA62-14-15	IA62-16-17	IA62-18
Cable Entry I.D.	A - expanded min. dia. (in)	1.20	3.00	1.70	3.20	4.90	1.25	2.35	5.25	2.39
	A - shrunk max. dia. (in)	0.37	0.90	0.36	1.40	2.32	0.43	0.98	1.40	1.45
	A - expanded min. dia. (mm)	30.5	76.2	43.2	81.3	124	31.8	59.7	133	60.7
	A - shrunk max. dia. (mm)	9.40	22.9	9.14	35.6	58.9	10.9	24.9	35.6	36.8
Conductor I.D.	C - expanded min. dia. (in)	0.50	1.45	0.82	1.40	2.00	0.50	1.00	1.35	0.80
	C - shrunk max. dia. (in)	0.11	0.30	0.12	0.50	1.00	0.11	0.28	0.53	0.35
	C - expanded min. dia. (mm)	12.7	36.8	20.8	35.6	50.8	12.7	25.4	34.3	20.3
	C - shrunk max. dia. (mm)	2.79	7.62	3.05	12.7	25.4	2.79	7.11	13.46	8.89
Body	E - expanded min. length (in)	2.5	3.5	2.3	3.5	7.5	2.3	6.8	6.0	3.4
	E - expanded min. length (mm)	63.5	88.9	58.4	88.9	191	58.4	173	152	86.4
Legs	F - expanded min. length (in)	1.0	1.5	2.2	1.6	2.5	1.0	1.7	3.0	2.0
	F - expanded min. length (mm)	25.4	38.1	55.9	40.6	63.5	25.4	43.2	76.2	50.8
Wall	Min. wall shrunk (in)	0.07	0.12	0.12	0.12	0.12	0.09	0.14	0.14	0.10
	Min. wall shrunk (mm)	1.78	3.05	3.05	3.05	3.05	2.29	3.56	3.56	2.54

California

1959 East Cashdan Street, Rancho Dominguez, CA 90220
(310) 609-1811 • (800) 326-0006 • FAX: (310) 609-1862
E-Mail: salesrd@std-wire.com

Arizona

3120 West Thomas Road, Bldg. #801, Phoenix, AZ 85017
(602) 269-2501 • (800) 325-6478 • FAX: (602) 278-7134
E-Mail: salesphx@std-wire.com



Standard Wire & Cable Co.

Cable Breakout Boot

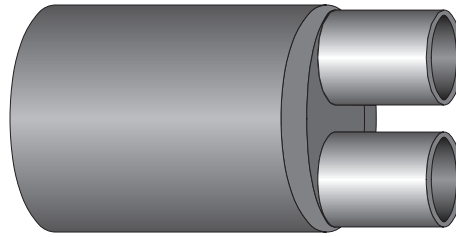
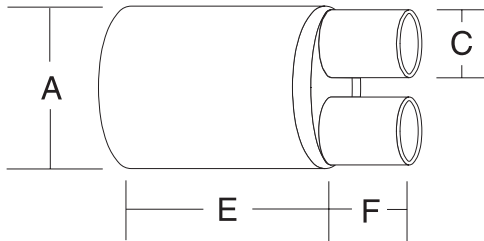

MATERIAL: Semirigid, flame-retardant, polyolefin, per MIL-I-81765/1.

DESIGN: Meets or exceeds Navsea Diagram No. 803-5001027.

USES: Heat shrinkable boots can be used for cable splices, breakouts, transitions, and any applications requiring water tightness. They provide excellent insulation, corrosion and weather resistance, as well as abrasion and mechanical protection.

Boot Style	2 Legs				3 Legs							
Catalog No.	91342-1	91342-2	91342-3	91342-4	91343-1	91343-2	91343-2A	91343-3	91343-4	91343-5	91343-6	
Cable MCM	3, 4, 6, 9	14, 23, 30	50, 75, 83, 100	200, 250, 300, 400	3, 4, 6, 9	14, 23	-	42, 50, 75, 100	150, 200, 250, 300	400	500, 600	
Navy Part No.	IA62-1	IA62-2	IA62-3	IA62-4	IA62-5	IA62-6	IA62-7	IA62-8	IA62-9	IA62-10	IA62-11	
Cable Entry I.D.	A - expanded min. dia. (in)	0.80	1.20	1.90	3.00	0.90	1.20	1.50	1.70	2.40	3.20	4.90
	A - shrunk max. dia. (in)	0.37	0.60	0.90	1.50	0.36	0.69	0.50	0.90	1.40	2.00	2.32
	A - expanded min. dia. (mm)	20.3	30.5	48.3	76.2	22.9	30.5	38.1	43.2	61.0	81.3	124
	A - shrunk max. dia. (mm)	9.40	15.2	22.9	38.1	9.14	17.5	12.7	22.9	35.6	50.8	58.9
Conductor I.D.	C - expanded min. dia. (in)	0.33	0.50	0.75	1.45	0.33	0.50	0.65	0.82	1.25	1.40	2.00
	C - shrunk max. dia. (in)	0.11	0.17	0.30	0.50	0.12	0.18	0.16	0.30	0.50	0.75	1.00
	C - expanded min. dia. (mm)	8.38	12.7	19.1	36.8	8.4	12.7	16.5	20.8	31.8	35.6	50.8
	C - shrunk max. dia. (mm)	2.79	4.32	7.62	12.7	3.05	4.57	4.06	7.62	12.7	19.1	25.4
Body	E - expanded min. length (in)	2.0	2.5	3.0	3.5	2.0	2.3	1.8	2.3	3.5	3.5	7.5
	E - expanded min. length (mm)	50.8	63.5	76.2	88.9	50.8	58.4	45.7	58.4	88.9	88.9	191
Legs	F - expanded min. length (in)	0.7	1.0	1.2	1.5	0.7	1.0	2.2	1.2	1.6	1.6	2.5
	F - expanded min. length (mm)	17.8	25.4	30.5	38.1	17.8	25.4	55.9	30.5	40.6	40.6	63.5
Wall	Min. wall shrunk (in)	0.05	0.07	0.10	0.12	0.08	0.09	0.09	0.12	0.12	0.14	0.12
	Min. wall shrunk (mm)	1.27	1.78	2.54	3.05	2.03	2.29	2.29	3.05	3.05	3.56	3.05

California

1959 East Cashdan Street, Rancho Dominguez, CA 90220
 (310) 609-1811 • (800) 326-0006 • FAX: (310) 609-1862
 E-Mail: salesrd@std-wire.com



Arizona

3120 West Thomas Road, Bldg. #801, Phoenix, AZ 85017
 (602) 269-2501 • (800) 325-6478 • FAX: (602) 278-7134
 E-Mail: salesphx@std-wire.com



Standard Wire & Cable Co.

Cable Breakout Boot (cont.)

Boot Style		4 Legs					6 Legs	8 Legs	
									
Catalog No.		91344-1	91344-2	91344-3	91344-4	91344-5	91344-6	91346-3	91348-2
Cable MCM		3, 4, 6, 9	23	42, 50, 60	75, 100	133, 150, 200	400, 500	100, 125, 150, 200	100, 125, 150
Navy Part No.		IA62-12	IA62-13	IA62-14	IA62-15	IA62-16	IA62-17	IA62-18	-
Cable Entry I.D.	A - expanded min. dia. (in)	0.90	1.25	1.75	2.35	2.65	5.25	2.39	2.25
	A - shrunk max. dia. (in)	0.43	0.80	0.98	1.00	1.40	3.00	1.45	1.32
	A - expanded min. dia. (mm)	22.9	31.8	44.5	59.7	67.3	133	60.7	57.2
	A - shrunk max. dia. (mm)	10.9	20.3	24.9	25.4	35.6	76.2	36.8	33.5
Conductor I.D.	C - expanded min. dia. (in)	0.28	0.50	0.79	1.00	1.20	1.35	0.80	0.56
	C - shrunk max. dia. (in)	0.11	0.19	0.28	0.35	0.53	0.55	0.35	0.19
	C - expanded min. dia. (mm)	7.11	12.7	20.1	25.4	30.5	34.3	20.3	14.2
	C - shrunk max. dia. (mm)	2.79	4.83	7.11	8.89	13.5	14.0	8.89	4.83
Body	E - expanded min. length (in)	2.00	2.30	2.30	6.80	3.50	6.00	3.40	2.00
	E - expanded min. length (mm)	50.8	58.4	58.4	173	88.9	152	86.4	50.8
Legs	F - expanded min. length (in)	0.75	1.00	1.20	1.70	1.50	3.00	2.00	1.25
	F - expanded min. length (mm)	19.1	25.4	30.5	43.2	38.1	76.2	50.8	31.8
Wall	Min. wall shrunk (in)	0.05	0.09	0.14	0.14	0.14	0.13	0.10	0.10
	Min. wall shrunk (mm)	1.27	2.29	3.56	3.56	3.56	3.30	2.54	2.54

California

1959 East Cashdan Street, Rancho Dominguez, CA 90220
 (310) 609-1811 • (800) 326-0006 • FAX: (310) 609-1862
 E-Mail: salesrd@std-wire.com

Arizona

3120 West Thomas Road, Bldg. #801, Phoenix, AZ 85017
 (602) 269-2501 • (800) 325-6478 • FAX: (602) 278-7134
 E-Mail: salesphx@std-wire.com



Standard Wire & Cable Co.

HRSR High-Ratio Sphincter Ring (Patented*)

HRSR is a high-ratio heat shrinkable strain relief grommet that can be placed over the cable assembly after the assembly is fabricated.

- PRODUCT FEATURES:
- Less assembly time
 - Superior strain relief
 - Less rework
 - Rework made easier

CONSTRUCTION: Conforms to Type I semirigid insulation MIL-I-81765/1.

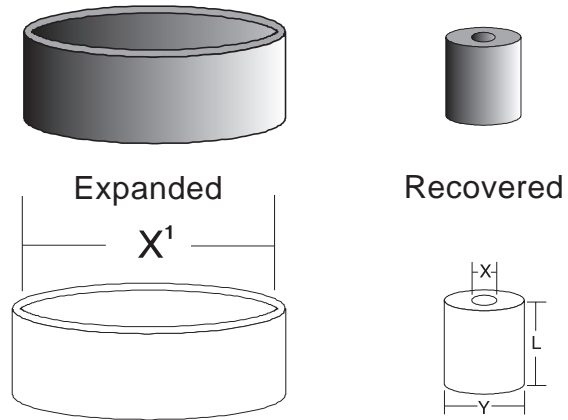

Catalog No.	I.D. Expanded - X ¹		I.D. Recovered - X		O.D. - Y		Length - L		Weight		Packing Tube Color	Connector Sizes
	(in)	(mm)	(in)	(mm)	(in)	(mm)	(in)	(mm)	(oz)	(g)		
HRSR-1	1.00	25.4	0.045	1.14	0.250	6.35	0.500	12.7	0.03	0.75	brown	8,9
HRSR-2	1.225	31.12	0.062	1.57	0.375	9.53	0.500	12.7	0.04	1.0	red	10,11,12,13
HRSR-3	1.437	36.50	0.125	3.18	0.500	12.7	0.500	12.7	0.053	1.50	orange	14,15,16,17
HRSR-4	1.85	47.0	0.125	3.18	0.562	14.3	0.750	19.1	0.123	3.50	yellow	18,19,20,21
HRSR-5	2.00	50.8	0.125	3.18	0.812	20.6	0.750	19.1	0.18	5.0	green	22,23,24,25,28

Packed by size on color coded cardboard tubes, 10 to a tube.

NOTES: Recovered length will allow for 0.075 in. (1.91 mm) either side of the collar, minimum. Recovered I.D. will conform to all wire arrangements available in the connector size. For fire wall applications, consult Standard Wire & Cable Co. Larger and custom sizes available.

* HRSR is a patent of XL Technologies.

California

1959 East Cashdan Street, Rancho Dominguez, CA 90220
(310) 609-1811 • (800) 326-0006 • FAX: (310) 609-1862
E-Mail: salesrd@std-wire.com

Arizona

3120 West Thomas Road, Bldg. #801, Phoenix, AZ 85017
(602) 269-2501 • (800) 325-6478 • FAX: (602) 278-7134
E-Mail: salesphx@std-wire.com



Standard Wire & Cable Co.

BENEFITS: Our heat shrinkable grommets put an end to costly taping resulting in less assembly time, superior strain relief, fewer errors, less rework, and rework made easier. Our heat shrinkable strain relief grommets can be placed over the cable assembly after the assembly is fabricated resulting in a superior strain relief and reduced labor cost of cable assembly. The extreme recovery conformity of the high expansion ratio material fills the cable interstices. When clamped into position, these grommets provide strain relief superior to all other types of grommets, tapes, and tape/grommet combinations. These grommets make repairs and rework simple. Simply heat the ring until soft, slide a nonmetallic probe through the center of the wire bundle enlarging the ring diameter. Cooled, the ring will remain open allowing wires to be added, removed, or reworked. After the cable's electrical properties are checked for correctness, the grommet is reheated and reshunk, repositioned, and reclamped in place.

USES: **Airlines:** Main landing gear switch and cables. Generator and starter cables for ground starting equipment. Cable bundling. **Airports:** Sealing cable splices for direct burial on runway lights. Sealing coax connectors for direct burial. **CATV Industry:** Above ground or direct burial sealing of CATV connectors and splices. **Electrical Generation & Distribution:** Sealing cable from conduit to main junction box. Sealing splices for direct burial or above ground cables. **Municipalities:** Above ground or direct burial sealing of connectors for fire alarm, traffic, and street signal departments. **Plant Maintenance:** Covering for electrical cable splices. Sealing steel cable splices. Cable repairs. **Railroads:** Splices on railroad signal cables for direct burial. Waterproof traction motor leads; protection against abrasion. Sealing splices on power cables. **Shipyard/Shipboard:** Protect and waterproof temporary ship-to-shore cables. Cover repair splices. Lifeline abrasion protection. **Truck Fleets:** Covering battery cable installations. Covering harness wires for taillights.

Specifications MIL-I-81765/1 Type 1 - Semirigid Insulation		
Property	Specification	Test Method
Specific gravity	1.4	ASTM-D-792
Hardness (Shore D)	45 +/-5	ASTM-D-2240
Tensile strength	1,200 to 1,500 psi / 8.3 to 10.3 MPa	ASTM-D-412
Elongation - ultimate	250% minimum	ASTM-D-412
Stiffness - maximum	25,000 psi / 172 MPa	ASTM-D-747
Water absorption	0.2 percent	ASTM-D-570A
Volume resistivity	10 ¹⁴ ohms-cm minimum	ASTM-D-257
Dielectric strength	200 volts/mil minimum / 7880 volts/mm minimum	ASTM-D-876
Low temperature flex	no cracking after 4 hours at -55°C +/-1°C (-67°F +/-2°F)	ASTM-D-2671C
Fluid resistance	1,200 psi/8.3 MPa minimum tensile 200% minimum ultimate elongation after 24 hours at 25°C +/-1°C (77°F +/-2°F)	ASTM-F-146
Heat resistance	1,200 psi/8.3 MPa minimum tensile 200% minimum ultimate elongation after 168 hours at 175°C +/-1°C (347°F +/-2°F)	ASTM-D-2671
Heat shock	no dripping, flowing, or cracking after 4 hours at 225°C +/-2°C (437°F +/-5°F)	ASTM-D-2671
Flammability	nonburning	ASTM-D-635
Corrosion resistance	no corrosion	ASTM-D-2671A
Elastic memory	minimum 275% expansion to 4 in (10 cm) of a fully recovered test specimen and minimum 93% recovery of expanded specimen after oven conditioning for 1 minute at 150°C +/-2°C (302°F +/-4°F)	

California

1959 East Cashdan Street, Rancho Dominguez, CA 90220
 (310) 609-1811 • (800) 326-0006 • FAX: (310) 609-1862
 E-Mail: salesrd@std-wire.com

Arizona

3120 West Thomas Road, Bldg. #801, Phoenix, AZ 85017
 (602) 269-2501 • (800) 325-6478 • FAX: (602) 278-7134
 E-Mail: salesphx@std-wire.com



Standard Wire & Cable Co.

High-Ratio Sphincter Ring Size Selection Chart

Series	Connector Size				
	8 9	10,12 11,13	14,16 15,17	18,20 19,21	22,24,28*
MIL-C-5015					
MS3451, 52, 56, 59	1	2	3	4	5
MS3450	2	3	4	5	*
MIL-C-26500**					
MS24266	1	2	3	4	5
MS24264, 65	2	3	4	5	*
MIL-C-26482					
MS3120, 21, 22, 26, M3470, 71,74, 75, 76	1	2	3	4	5
MS3124, MS3472	2	3	4	5	*
MIL-C-83723 Series I					
M83723/01&02, 05&06, 07&08, 13&14, 42&43	1	2	3	4	5
M83723/03&04	2	3	4	5	*
MIL-C-83723 Series II					
M83723/17&18, 23&24	1	2	3	4	5
M83723/12&20, 21&22	2	3	4	5	*
MIL-C-83723 Series III					
M83723/71&72-97&98	1	2	3	4	5
M83723/66, 67, 68&69	2	3	4	5	*
MIL-C-38999 Series I					
M27467	1	2	3	4	5
M27466, 68, 96, 27505, 27656	2	3	4	5	*
MIL-C-38999 Series II					
MS27472, 97, 98, 27508, 27513	1	2	3	4	5
MS27473, MS27474	3	4	5	5	*
MIL-C-38999 Series III					
D38999/26	1	2	3	4	5
D38999/20, 24	3	4	5	5	*
Boeing					
BACC45, F, M, N, P, R, S, T	-	2	3	4	5
BACC 63X	-	3	4	5	*
Douglas					
DC30, 31, 34, 35, 50-57	1	2	3	4	5
DC32, 33, 36, 37, 60, 61, 62, 63	2	3	4	5	*

Packing Tube Color Codes					
Size	1	2	3	4	5
Color	Brown	Red	Orange	Yellow	Green

* Larger sizes available

** Cable support clamp I.D. may affect the size of sphincter ring selected.

California

1959 East Cashdan Street, Rancho Dominguez, CA 90220
 (310) 609-1811 • (800) 326-0006 • FAX: (310) 609-1862
 E-Mail: salesrd@std-wire.com

Arizona

3120 West Thomas Road, Bldg. #801, Phoenix, AZ 85017
 (602) 269-2501 • (800) 325-6478 • FAX: (602) 278-7134
 E-Mail: salesphx@std-wire.com



Standard Wire & Cable Co.

Very Flexible Sealing Tape XTPA 080



TYPICAL PROPERTIES:

THERMAL:

Operating temperature	-75° C to 80° C	
Low temp. flexibility (-75° C)	No cracking after bending	ASTM-D-2671C

PHYSICAL:

Tensile strength	1500 psi	ASTM-D-412
Elongation at break	600%	ASTM-D-412
Water absorption	0.5 % maximum	ASTM-D-570
Specific gravity	1.0 maximum	ASTM-D-792
Peel strength		
PE to PE	80 N/25 mm	18 lbs/in
PVC to PVC	50 N/25 mm	11 lbs/in
Neoprene® to Neoprene®	80 N/25 mm	18 lbs/in
PE to aluminum	80 N/25 mm	18 lbs/in

CHEMICAL:

Corrosive effect	Noncorrosive	
Chemical resistance	Good	
Fungus resistance	Inert	ASTM-D-G21

ELECTRICAL:

Dielectric strength	20 kV/mm 500 V/Mil	ASTM-D-257
Volume resistivity	10 ¹⁰ ohm/cm	ASTM-D-149

COLOR:

Clear

USES:

XTPA 080 is a general purpose, very flexible thermoplastic adhesive tape based on a modified polyolefin. This tape will melt and flow to provide encapsulation, corrosion protection, and an environmental seal protection against moisture ingress in cable harnesses even at very low temperatures where flexibility is desired. It was developed to be used in conjunction with heat shrinkable molded shapes and tubings and can be multi-layered to any desired thickness. XTPA 080 bonds to material such as polyethylene, PVC, Neoprene®, Hypalon®, cross-linked polyolefins, and to many metals, such as steel and aluminum. XTPA 080 is cadmium and halogen free, and is supplied on a release paper to prevent layers from sticking.

Dimensions

Size (in)	Width		Thickness		Length per Roll	
	(in)	(mm)	(in)	(mm)	(ft)	(m)
1	1.0	25	0.01	0.25	75.0	22.9

Neoprene® is a trademark of the DuPont de Nemours Co.

Hypalon® is a trademark of the DuPont de Nemours Co.

California

1959 East Cashdan Street, Rancho Dominguez, CA 90220
 (310) 609-1811 • (800) 326-0006 • FAX: (310) 609-1862
 E-Mail: salesrd@std-wire.com

Arizona

3120 West Thomas Road, Bldg. #801, Phoenix, AZ 85017
 (602) 269-2501 • (800) 325-6478 • FAX: (602) 278-7134
 E-Mail: salesphx@std-wire.com



Standard Wire & Cable Co.

Shrink Tube MIL-I-23053/1 (SWCPLD-100)



COLOR: Black

PUT UP: Bulk spools

CONST: Certifies to MIL-I-23053/1, Classes 1 and 2. 2:1 Shrink ratio. Remains highly flexible under severe environmental conditions. Resistant to fuel, oil, abrasion, and cut-thru.

USES: Heavy duty harnessing, ground support, military or shipboard vehicles, repair and maintenance of trailing cables. MIL-H-5606 hydraulic, MIL-L-3056 gasoline, MIL-L-7808 lube oil, MIL-L-23699 lube oil, SS-S-550 5% NaCl, MIL-A-8243 deice fluid, MIL-F-46162 diesel fuel, MIL-C-372 bore cleaner, VV-F-800 diesel fuel, MIL-T-5624 JP4, JP5, and MIL-F-16884 marine fuel.

Catalog No.	Size (in)	Minimum Expansion		Maximum Recovered		Nominal Recovered Wall	
		(in)	(mm)	(in)	(mm)	(in)	(mm)
1501-99	1/8	0.125	3.18	0.062	1.57	0.027	0.686
1501-100	3/16	0.187	4.75	0.093	2.36	0.031	0.787
1501-101	1/4	0.250	6.35	0.126	3.20	0.035	0.889
1501-102	3/8	0.375	9.53	0.185	4.70	0.040	1.02
1501-103	1/2	0.500	12.7	0.252	6.40	0.048	1.22
1501-104	5/8	0.625	15.9	0.357	9.07	0.052	1.32
1501-105	3/4	0.750	19.1	0.374	9.50	0.057	1.45
1501-106	7/8	0.875	22.2	0.475	12.1	0.065	1.65
1501-107	1	1.000	25.40	0.500	12.7	0.070	1.78
1501-108	1-1/4	1.250	31.75	0.714	18.1	0.087	2.21
1501-109	1-1/2	1.500	38.10	0.857	21.8	0.095	2.41
1501-110	1-3/4	1.750	44.45	1.000	25.40	0.107	2.72
1501-111	2	2.000	50.80	1.140	28.96	0.110	2.79

Listed specifications meet or exceed military specification MIL-I-23053/1.

California

1959 East Cashdan Street, Rancho Dominguez, CA 90220
(310) 609-1811 • (800) 326-0006 • FAX: (310) 609-1862
E-Mail: salesrd@std-wire.com

Arizona

3120 West Thomas Road, Bldg. #801, Phoenix, AZ 85017
(602) 269-2501 • (800) 325-6478 • FAX: (602) 278-7134
E-Mail: salesphx@std-wire.com



Standard Wire & Cable Co.

Shrink Tube

MIL-I-23053/4 (SWCPLSRDW-100)



- COLOR:** Brown, gray, white, red, blue, yellow, and black. Other colors than listed available upon special order.
- PUT UP:** 4 foot lengths.
- CONST:** Certified to MIL-I-23053/4, Class 1. 3:1 shrink ratio on small sizes, 2.5:1 shrink ratio on large sizes. Shrink temperature of 125° C with operating temperatures of -55° C to 110° C. Inner liner melts and flows to provide an encapsulated environmental seal.
- USES:** Protects components against corrosion, shock, and vibration; provides strain relief for coaxial connectors, low cost cap, or transition. MIL-H-5606 hydraulic, MIL-L-7808 lube oil, MIL-T-5624 JP4, MIL-G-3056 gasoline, and SS-S-550 5% NaCl.

Catalog No.	Size (in)	Minimum Expansion		Maximum Recovered		Nominal Recovered Wall	
		(in)	(mm)	(in)	(mm)	(in)	(mm)
1504-101	1/8	0.125	3.18	0.023	0.584	0.038	0.965
1504-102	3/16	0.187	4.75	0.060	1.52	0.043	1.09
1504-103	1/4	0.250	6.35	0.080	2.03	0.047	1.19
1504-104	3/8	0.375	9.53	0.135	3.43	0.050	1.27
1504-105	1/2	0.500	12.7	0.195	4.95	0.055	1.40
1504-106	3/4	0.750	19.1	0.313	7.95	0.065	1.65
1504-107	1	1.000	25.40	0.400	10.2	0.075	1.91

Listed specifications meet or exceed military specification MIL-I-23053/4.

California

1959 East Cashdan Street, Rancho Dominguez, CA 90220
 (310) 609-1811 • (800) 326-0006 • FAX: (310) 609-1862
 E-Mail: salesrd@std-wire.com

Arizona

3120 West Thomas Road, Bldg. #801, Phoenix, AZ 85017
 (602) 269-2501 • (800) 325-6478 • FAX: (602) 278-7134
 E-Mail: salesphx@std-wire.com



Standard Wire & Cable Co.

Shrink Tube MIL-I-23053/4 (SWCPLDW-100)



COLOR: Black, clear. Other colors available upon special order.

PUT UP: 4 foot lengths or bulk spools.

CONST: Certified to MIL-I-23053/4, Classes 2 and 3, and UL specification 224 (black only). 3:1 shrink ratio. Shrink temperature of 125° C and operating temperatures of -55° C to 135° C. Thermoplastic adhesive liner bonds to provide excellent peel strength on most substrate materials.

USES: Strain relief, replacement of some breakouts and caps when crimped while shrinking, tamper proof cover for wire markers, insulates crimped splices. MIL-H-5606 hydraulic, MIL-I-23699 lube oil, SS-S-550 5% NaCl, MIL-T-5624 JP4, MIL-L-7808 lube oil, and MIL-A-8243 deice fluid.

Catalog No.	Size (in)	Minimum Expansion		Maximum Recovered		Nominal Recovered Wall	
		(in)	(mm)	(in)	(mm)	(in)	(mm)
1504-301	1/8	0.125	3.18	0.040	1.02	0.060	1.52
1504-301A	3/16	0.187	4.75	0.070	1.78	0.063	1.60
1504-302	1/4	0.250	6.35	0.080	2.03	0.063	1.60
1504-302A	3/8	0.375	9.53	0.120	3.05	0.075	1.91
1504-303	1/2	0.500	12.7	0.157	3.99	0.087	2.21
1504-303A	3/4	0.750	19.1	0.230	5.84	0.110	2.79
1504-304	1	1.000	25.40	0.320	8.13	0.138	3.51
1504-305	1-1/2	1.500	38.10	0.530	13.5	0.138	3.51

Listed specifications meet or exceed military specification MIL-I-23053/4.

California

1959 East Cashdan Street, Rancho Dominguez, CA 90220
(310) 609-1811 • (800) 326-0006 • FAX: (310) 609-1862
E-Mail: salesrd@std-wire.com

Arizona

3120 West Thomas Road, Bldg. #801, Phoenix, AZ 85017
(602) 269-2501 • (800) 325-6478 • FAX: (602) 278-7134
E-Mail: salesphx@std-wire.com



Standard Wire & Cable Co.

Shrink Tube

MIL-I-23053/4 (SWCPLDW-104)



COLOR: Black, clear. Other colors available upon special order.

PUT UP: 4 foot lengths.

CONST: Meets MIL-I-23053/4, Class 3. 4:1 shrink ratio. Clear material provides environmental seal, yet allows visual inspection. Black material is flame-retardant.

USES: Cost effective strain relief boot. Harness repair on-site without removing connectors. Splice protection. MIL-H-5606 hydraulic, MIL-I-23699 lube oil, SS-S-550 5% NaCl, MIL-T-5624 JP4, MIL-L-7808 lube oil, and MIL-A-8243 deice fluid.

Catalog No.	Size (in)	Minimum Expansion		Maximum Recovered		Nominal Recovered Wall	
		(in)	(mm)	(in)	(mm)	(in)	(mm)
1504-401	3/16	0.157	3.99	0.040	1.02	0.060	1.52
1504-402	5/16	0.315	8.00	0.080	2.03	0.063	1.60
1504-403	1/2	0.500	12.7	0.120	3.05	0.075	1.91
1504-403A	5/8	0.625	15.9	0.157	3.99	0.087	2.21
1504-404	1	1.000	25.40	0.236	5.99	0.110	2.79
1504-405	1-1/4	1.250	31.75	0.315	8.00	0.137	3.48

Listed specifications meet or exceed military specification MIL-I-23053/4.

California

1959 East Cashdan Street, Rancho Dominguez, CA 90220
(310) 609-1811 • (800) 326-0006 • FAX: (310) 609-1862
E-Mail: salesrd@std-wire.com

Arizona

3120 West Thomas Road, Bldg. #801, Phoenix, AZ 85017
(602) 269-2501 • (800) 325-6478 • FAX: (602) 278-7134
E-Mail: salesphx@std-wire.com



Standard Wire & Cable Co.

Shrink Tube MIL-I-23053/5 (SWCPLF-100)



- COLOR:** Black, white, red, yellow, blue, green, and clear. Other colors available upon special order.
- PUT UP:** 4 foot lengths or bulk spools.
- CONST:** Certified to MIL-I-23053/5, Classes 1, 2, and 3. 2:1 shrink ratio. Shrink temperature of 125° C and operating temperatures of -75° C to 125° C.
- USES:** Insulation, wire markers, strain relief, wire bundling, mechanical protection, and color coding. MIL-H-5606 hydraulic, MIL-I-23699 lube oil, SS-S-550 5% NaCl, MIL-T-5624 JP4, MIL-L-7808 lube oil, and MIL-A-8243 deice fluid.

Catalog No.	Size (in)	Minimum Expansion		Maximum Recovered		Nominal Recovered Wall	
		(in)	(mm)	(in)	(mm)	(in)	(mm)
1505-101	3/64	0.046	1.17	0.023	0.584	0.016	0.406
1505-102	1/16	0.063	1.60	0.031	0.787	0.017	0.432
1505-103	3/32	0.093	2.36	0.046	1.17	0.020	0.508
1505-104	1/8	0.125	3.18	0.062	1.57	0.020	0.508
1505-105	3/16	0.187	4.75	0.093	2.36	0.020	0.508
1505-106	1/4	0.250	6.35	0.125	3.18	0.025	0.635
1505-107	3/8	0.375	9.53	0.187	4.75	0.025	0.635
1505-108	1/2	0.500	12.7	0.250	6.35	0.025	0.635
1505-108D	5/8	0.625	15.9	0.312	7.92	0.028	0.711
1505-109	3/4	0.750	19.1	0.375	9.53	0.030	0.762
1505-110	1	1.000	25.40	0.500	12.70	0.035	0.889
1505-111	1-1/2	1.500	38.10	0.750	19.05	0.040	1.02
1505-112	2	2.000	50.80	1.000	25.40	0.045	1.14
1505-113	3	3.000	76.20	1.500	38.10	0.050	1.27
1505-114	4	4.000	101.6	2.000	50.80	0.055	1.40

Listed specifications meet or exceed military specification MIL-I-23053/5.

California

1959 East Cashdan Street, Rancho Dominguez, CA 90220
(310) 609-1811 • (800) 326-0006 • FAX: (310) 609-1862
E-Mail: salesrd@std-wire.com

Arizona

3120 West Thomas Road, Bldg. #801, Phoenix, AZ 85017
(602) 269-2501 • (800) 325-6478 • FAX: (602) 278-7134
E-Mail: salesphx@std-wire.com



Standard Wire & Cable Co.

Shrink Tube MIL-I-23053/5 (SWCPLF-103)



COLOR: Black, white. Other colors available on special order.

PUT UP: 4 foot lengths or bulk spools.

CONST: Certified to MIL-I-23053/5. 3:1 shrink ratio. Shrink temperature of 125° C and operating temperatures of -55° C to 135° C.

USES: Insulation of irregularly shaped components covering a wide range of diameters on a single harness, strain relief from connector to wires. MIL-H-5606 hydraulic, MIL-I-23699 lube oil, SS-S-550 5% NaCl, MIL-T-5624 JP4, MIL-L-7808 lube oil, and MIL-A-8243 deice fluid.

Catalog No.	Size (in)	Minimum Expansion		Maximum Recovered		Nominal Recovered Wall	
		(in)	(mm)	(in)	(mm)	(in)	(mm)
1505-302	1/16	0.063	1.60	0.020	0.508	0.018	0.457
1505-304	1/8	0.125	3.18	0.040	1.02	0.022	0.559
1505-306	1/4	0.250	6.35	0.080	2.03	0.026	0.660
1505-307	3/8	0.375	9.53	0.120	3.05	0.030	0.762
1505-308	1/2	0.500	12.7	0.160	4.06	0.030	0.762
1505-309	3/4	0.750	19.1	0.250	6.35	0.030	0.762
1505-310	1	1.000	25.40	0.320	8.13	0.040	1.02
1505-311	1-1/4	1.500	38.10	0.500	12.7	0.045	1.14

Listed specifications meet or exceed military specification MIL-I-23053/5.

California

1959 East Cashdan Street, Rancho Dominguez, CA 90220
(310) 609-1811 • (800) 326-0006 • FAX: (310) 609-1862
E-Mail: salesrd@std-wire.com

Arizona

3120 West Thomas Road, Bldg. #801, Phoenix, AZ 85017
(602) 269-2501 • (800) 325-6478 • FAX: (602) 278-7134
E-Mail: salesphx@std-wire.com



Standard Wire & Cable Co.

Shrink Tube MIL-I-23053/5 (SWCPLF-104)



- COLOR:** Black.
- PUT UP:** 4 foot lengths.
- CONST:** Certified to MIL-I-23053/5, Class 1. 4:1 shrink ratio. Shrink temperature of 125° C and operating temperatures of -55° C to 135° C. Allows for on-site repairs.
- USES:** Repair and rework of cable jackets, ability to install wire markers over preinstalled connectors, replaces molded shape designed for strain relief. MIL-H-5606 hydraulic, MIL-I-23699 lube oil, SS-S-550 5% NaCl, MIL-T-5624 JP4, MIL-L-7808 lube oil, and MIL-A-8243 deice fluid.

Catalog No.	Size (in)	Minimum Expansion		Maximum Recovered		Nominal Recovered Wall	
		(in)	(mm)	(in)	(mm)	(in)	(mm)
1504-410	1	1.000	25.40	0.250	6.35	0.060	1.52
1504-411	1-1/2	1.500	38.10	0.375	9.53	0.060	1.52
1504-412	2	2.000	50.80	0.500	12.7	0.060	1.52
1504-413	3	3.000	76.20	0.750	19.1	0.060	1.52
1504-414	4	4.000	101.6	1.000	25.40	0.060	1.52

Listed specifications meet or exceed military specification MIL-I-23053/5.

California

1959 East Cashdan Street, Rancho Dominguez, CA 90220
(310) 609-1811 • (800) 326-0006 • FAX: (310) 609-1862
E-Mail: salesrd@std-wire.com

Arizona

3120 West Thomas Road, Bldg. #801, Phoenix, AZ 85017
(602) 269-2501 • (800) 325-6478 • FAX: (602) 278-7134
E-Mail: salesphx@std-wire.com



Standard Wire & Cable Co.

Shrink Tube MIL-I-23053/6 (SWCPLSR-100)



COLOR: Black, clear. Other colors available upon special order.

PUT UP: 4 foot lengths.

CONST: Certified to MIL-I-23053/6. 2:1 shrink ratio. Shrink temperature of 135° C and operating temperatures of -55° C to 135° C.

USES: Strain relief of soldered connections or terminals, protection of wire splices. MIL-H-5606 hydraulic, MIL-I-23699 lube oil, SS-S-550 5% NaCl, MIL-T-5624 JP4, MIL-L-7808 lube oil, and MIL-A-8243 deice fluid.

Catalog No.	Size (in)	Minimum Expansion		Maximum Recovered		Nominal Recovered Wall	
		(in)	(mm)	(in)	(mm)	(in)	(mm)
1506-101	3/64	0.046	1.17	0.023	0.584	0.020	0.508
1506-102	1/16	0.063	1.60	0.031	0.787	0.020	0.508
1506-103	3/32	0.093	2.36	0.046	1.17	0.020	0.508
1506-104	1/8	0.125	3.18	0.062	1.57	0.020	0.508
1506-105	3/16	0.187	4.75	0.093	2.36	0.025	0.635
1506-106	1/4	0.250	6.35	0.125	3.18	0.025	0.635
1506-107	3/8	0.375	9.53	0.187	4.75	0.030	0.762
1506-108	1/2	0.500	12.7	0.250	6.35	0.030	0.762
1506-112	1	1.000	25.40	0.500	12.7	0.033	0.838

Listed specifications meet or exceed military specification MIL-I-23053/6.

California

1959 East Cashdan Street, Rancho Dominguez, CA 90220
(310) 609-1811 • (800) 326-0006 • FAX: (310) 609-1862
E-Mail: salesrd@std-wire.com

Arizona

3120 West Thomas Road, Bldg. #801, Phoenix, AZ 85017
(602) 269-2501 • (800) 325-6478 • FAX: (602) 278-7134
E-Mail: salesphx@std-wire.com



Standard Wire & Cable Co.

Shrink Tube MIL-I-23053/8 (KYNAR®)



COLOR: Clear. Other colors available upon special order.

PUT UP: 4 foot lengths.

CONST: Certified to MIL-I-23053/8. 2:1 shrink ratio. Continuous operating temperatures of -55° C to 175° C. Resistance to abrasion, cut-thru, and corrosion with a low profile ultrathin wall.

USES: Aerospace harnesses, lack of color pigment allows visual inspection of strain relief, and protection in high temperature, high performance environments. MIL-H-5606 hydraulic, MIL-I-23699 lube oil, SS-S-550 5% NaCl, MIL-T-5624 JP4, MIL-L-7808 lube oil, and MIL-A-8243 deice fluid.

Catalog No.	Size (in)	Minimum Expansion		Maximum Recovered		Nominal Recovered Wall	
		(in)	(mm)	(in)	(mm)	(in)	(mm)
1508-101	3/64	0.046	1.17	0.023	0.584	0.010	0.254
1508-102	1/16	0.063	1.60	0.031	0.787	0.010	0.254
1508-103	3/32	0.093	2.36	0.046	1.17	0.010	0.254
1508-104	1/8	0.125	3.18	0.062	1.57	0.010	0.254
1508-105	3/16	0.187	4.75	0.093	2.36	0.010	0.254
1508-106	1/4	0.250	6.35	0.125	3.18	0.012	0.305
1508-107	3/8	0.375	9.53	0.187	4.75	0.012	0.305
1508-108	1/2	0.500	12.7	0.250	6.35	0.012	0.305
1508-109	3/4	0.750	19.1	0.375	9.53	0.017	0.432
1508-110	1	1.000	25.40	0.500	12.7	0.019	0.483

Listed specifications meet or exceed military specification MIL-I-23053/8.

Kynar® is a registered trademark of Pennwalt Corporation.

California

1959 East Cashdan Street, Rancho Dominguez, CA 90220
(310) 609-1811 • (800) 326-0006 • FAX: (310) 609-1862
E-Mail: salesrd@std-wire.com

Arizona

3120 West Thomas Road, Bldg. #801, Phoenix, AZ 85017
(602) 269-2501 • (800) 325-6478 • FAX: (602) 278-7134
E-Mail: salesphx@std-wire.com



Standard Wire & Cable Co.

Shrink Tube MIL-I-23053/13 (VITON®)



COLOR: Black.

PUT UP: Bulk spools.

CONST: Certified to MIL-I-23053/13. 2:1 shrink ratio. High operating temperature of 200° C. High resistance to fuels, lubricants, solvents, and abrasions.

USES: Mechanical protection, insulation of components and cable harnesses. MIL-H-5606 hydraulic, MIL-I-23699 lube oil, SS-S-550 5% NaCl, MIL-T-5624 JP4, JP5, MIL-L-7808 lube oil, MIL-F-16884 marine fuel, and MIL-A-8243 deice fluid.

Catalog No.	Size (in)	Minimum Expansion		Maximum Recovered		Nominal Recovered Wall	
		(in)	(mm)	(in)	(mm)	(in)	(mm)
1513-100	1/8	0.125	3.18	0.062	1.57	0.031	0.787
1513-101	3/16	0.187	4.75	0.094	2.39	0.035	0.889
1513-102	1/4	0.250	6.35	0.125	3.18	0.035	0.889
1513-103	3/8	0.375	9.53	0.187	4.75	0.035	0.89
1513-104	1/2	0.500	12.7	0.250	6.35	0.035	0.89
1513-105	5/8	0.625	15.9	0.312	7.92	0.042	1.07
1513-106	3/4	0.750	19.1	0.375	9.53	0.042	1.07
1513-106D	7/8	0.875	22.2	0.437	11.1	0.049	1.24
1513-108	1	1.000	25.40	0.500	12.7	0.049	1.24
1513-110	1-1/2	1.500	38.10	0.750	19.1	0.055	1.40
1513-111	2	2.000	50.80	1.000	25.4	0.065	1.65

Listed specifications meet or exceed military specification MIL-I-23053/13.

Viton® is a trademark of DuPont Dow Elastomers.

California

1959 East Cashdan Street, Rancho Dominguez, CA 90220
(310) 609-1811 • (800) 326-0006 • FAX: (310) 609-1862
E-Mail: salesrd@std-wire.com

Arizona

3120 West Thomas Road, Bldg. #801, Phoenix, AZ 85017
(602) 269-2501 • (800) 325-6478 • FAX: (602) 278-7134
E-Mail: salesphx@std-wire.com



Standard Wire & Cable Co.

Shrink Tube MIL-I-23053/16 (SWCPLD-101)



COLOR: Black.

PUT UP: Bulk spools.

CONST: Certified to MIL-I-23053/16, Class 2. 2:1 shrink ratio. Shrink temperature of 135° C and operating temperatures of -70° C to 150° C. High resistance to abrasions, cut-thru, oil, and fuel.

USES: Military ground vehicle harnesses where severe temperatures and environmental conditions are critical. MIL-H-5606 hydraulic, MIL-I-23699 lube oil, SS-S-550 5% NaCl, MIL-F-16884 marine fuel, MIL-F-46162 diesel fuel, VV-F-800 diesel fuel, MIL-T-5624 JP4, JP5, MIL-L-7808 lube oil, MIL-A-8243 deice fluid, MIL-G-3056 gasoline, and MIL-C-372 bore cleaner.

Catalog No.	Size (in)	Minimum Expansion		Maximum Recovered		Nominal Recovered Wall	
		(in)	(mm)	(in)	(mm)	(in)	(mm)
1516-99	1/8	0.125	3.18	0.062	1.57	0.027	0.686
1516-100	3/16	0.187	4.75	0.093	2.36	0.031	0.787
1516-101	1/4	0.250	6.35	0.125	3.18	0.035	0.889
1516-102	3/8	0.375	9.53	0.187	4.75	0.040	1.02
1516-103	1/2	0.500	12.7	0.250	6.35	0.048	1.22
1516-103A	5/8	0.625	15.9	0.357	9.07	0.057	1.45
1516-104	3/4	0.750	19.1	0.376	9.55	0.057	1.45
1516-104A	7/8	0.875	22.2	0.475	12.1	0.070	1.78
1516-105	1	1.000	25.40	0.500	12.7	0.070	1.78
1516-105A	1-1/4	1.250	31.75	0.714	18.1	0.087	2.21
1516-106	1-1/2	1.500	38.10	0.750	19.1	0.095	2.41

Listed specifications meet or exceed military specification MIL-I-23053/16.

California

1959 East Cashdan Street, Rancho Dominguez, CA 90220
(310) 609-1811 • (800) 326-0006 • FAX: (310) 609-1862
E-Mail: salesrd@std-wire.com

Arizona

3120 West Thomas Road, Bldg. #801, Phoenix, AZ 85017
(602) 269-2501 • (800) 325-6478 • FAX: (602) 278-7134
E-Mail: salesphx@std-wire.com



Technical Data & Conversion Tables

Recovered Wall Thickness Polyfit 2:1 Shrink Ratio Tubing

% Recovery	K	% Recovery	K	% Recovery	K
1	0.505	34	0.670	67	0.835
2	0.510	35	0.675	68	0.840
3	0.515	36	0.680	69	0.845
4	0.520	37	0.685	70	0.850
5	0.525	38	0.690	71	0.855
6	0.530	39	0.695	72	0.860
7	0.535	40	0.700	73	0.865
8	0.540	41	0.705	74	0.870
9	0.545	42	0.710	75	0.875
10	0.550	43	0.715	76	0.880
11	0.555	44	0.720	77	0.885
12	0.560	45	0.725	78	0.890
13	0.565	46	0.730	79	0.895
14	0.570	47	0.735	80	0.900
15	0.575	48	0.740	81	0.905
16	0.580	49	0.745	82	0.910
17	0.585	50	0.750	83	0.915
18	0.590	51	0.755	84	0.920
19	0.595	52	0.760	85	0.925
20	0.600	53	0.765	86	0.930
21	0.605	54	0.770	87	0.935
22	0.610	55	0.775	88	0.940
23	0.615	56	0.780	89	0.945
24	0.620	57	0.785	90	0.950
25	0.625	58	0.790	91	0.955
26	0.630	59	0.795	92	0.960
27	0.635	60	0.800	93	0.965
28	0.640	61	0.805	94	0.970
29	0.645	62	0.810	95	0.975
30	0.650	63	0.815	96	0.980
31	0.655	64	0.820	97	0.985
32	0.660	65	0.825	98	0.990
33	0.665	66	0.830	99	0.995

To determine the wall thickness of any 2:1 shrink-ratio at any percentage of recovery, find the percentage recovery in the above table and multiply the fully recovered wall thickness of the tubing by the constant, K, located opposite the percentage of recovery.

Example: What will the wall thickness of polyfit SWCPLF-100, size 1/8" tubing be when the tubing is recovered 30%?

Solution: Constant K for 30% recovery is 0.650. The fully recovered nominal wall thickness of the tubing per the product specification is 0.020 inches (0.051 mm). 0.020 inches x 0.650 = 0.013 inches or 0.03315 mm wall thickness at 30% recovery.

This method is mathematically correct and the values derived from it are useful in practice. The method and values cannot, however, take into account individual variations in tubing manufacture and nominal values or ranges of tolerances in the specifications of same, or variations in the application of the tubing.

Temperature Conversions

Celsius (Centigrade) to Fahrenheit
Fahrenheit to Celsius

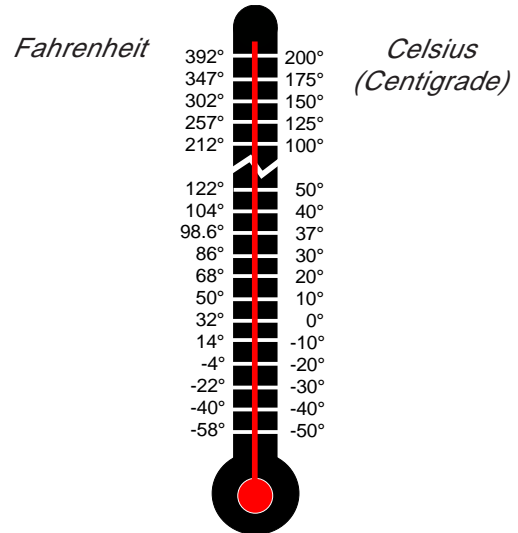

$$F^{\circ} = 9/5 C^{\circ} + 32^{\circ}$$

$$C^{\circ} = (F^{\circ} - 32^{\circ}) 5/9$$

Mathematical Formulas

Diameter of Circle: circumference \div 3.1416

Circumference of Circle: diameter x 3.1416

Area of Circle: radius² x 3.1416 or diameter² x 0.7854

Area of Triangle: base x 0.5 altitude

Area of Parallelogram (incl. rectangle): base x altitude

Surface Area of Sphere: diameter² x 3.1416

Volume of Sphere: diameter³ x 0.5236

Volume of Prism or Cylinder: area of base x altitude

Volume of Pyramid or Cone: area of base x $1/3$ altitude

California

1959 East Cashdan Street, Rancho Dominguez, CA 90220
(310) 609-1811 • (800) 326-0006 • FAX: (310) 609-1862
E-Mail: salesrd@std-wire.com

Arizona

3120 West Thomas Road, Bldg. #801, Phoenix, AZ 85017
(602) 269-2501 • (800) 325-6478 • FAX: (602) 278-7134
E-Mail: salesphx@std-wire.com



Standard Wire & Cable Co.

Conversion Tables and Equivalencies

Fractional Inches & Millimeters

Fractional	Decimal	mm
1/64	0.015625	
	1/32	0.03125
		0.03937
		1
3/64	0.046875	
	1/16	0.0625
5/64	0.078125	
		0.07874
		2
	3/32	0.09375
7/64	0.109375	
		0.11811
		3
	1/8	0.125
9/64	0.140625	
	5/32	0.15625
		0.15748
		4
11/64	0.171875	
	3/16	0.1875
		0.19685
		5
13/64	0.203125	
	7/32	0.21875
15/64	0.234375	
		0.23622
		6
	1/4	0.25
17/64	0.265625	
		0.27559
		7
	9/32	0.28125
19/64	0.296875	
	5/16	0.3125
		0.31496
		8
21/64	0.328125	
	11/32	0.34375
		0.35433
		9
23/64	0.359375	
	3/8	0.375
25/64	0.390625	
		0.3937
		10
	13/32	0.40625
27/64	0.421875	
		0.43307
		11
	7/16	0.4375
29/64	0.453125	
	15/32	0.4875
		0.47244
		12
31/64	0.484375	
	1/2	0.5

Decimal Equivalents of Millimeters

Fractional	Decimal	mm
33/64	0.515625	
		0.51181
		13
	17/32	0.53125
35/64	0.546875	
		0.55118
		14
	9/16	0.5625
37/64	0.578125	
		0.59055
		15
	19/32	0.59375
39/64	0.609375	
	5/8	0.625
		0.62992
		16
41/64	0.640625	
	21/32	0.65625
		0.66929
		17
43/64	0.671875	
	11/16	0.6875
45/64	0.703125	
		0.70866
		18
	23/32	0.71875
47/64	0.734375	
		0.74803
		19
	3/4	0.75
49/64	0.765625	
	25/32	0.78125
		0.7874
		20
51/64	0.796875	
	13/16	0.8175
		0.82677
		21
53/64	0.828125	
	27/32	0.84375
55/64	0.859375	
		0.86614
		22
	7/8	0.875
57/64	0.890625	
		0.90551
		23
	29/32	0.90625
59/64	0.921875	
	15/16	0.9375
		0.94488
		24
61/64	0.953125	
	31/32	0.96875
		0.98425
		25
63/64	0.984375	

mm	in
25	0.984252
26	1.023622
27	1.062992
28	1.102362
29	1.141732
30	1.181102
31	1.220472
32	1.259843
33	1.299213
34	1.338583
35	1.377953
36	1.417323
37	1.456693
38	1.496063
39	1.535433
40	1.574803
41	1.614173
42	1.653543
43	1.692913
44	1.732283
45	1.771654
46	1.811024
47	1.850394
48	1.889764
49	1.929134
50	1.968504
51	2.007874
52	2.047244
53	2.086614
54	2.125984
55	2.165354
56	2.204724
57	2.244094
58	2.283465
59	2.322835
60	2.362205
61	2.401575
62	2.440945

mm	in
63	2.480315
64	2.519685
65	2.559055
66	2.598425
67	2.637795
68	2.677165
69	2.716535
70	2.755906
71	2.795276
72	2.834646
73	2.874016
74	2.913386
75	2.952756
76	2.992126
77	3.031496
78	3.070866
79	3.110236
80	3.149606
81	3.188976
82	3.228346
83	3.267717
84	3.307087
85	3.346457
86	3.385827
87	3.425197
88	3.464567
89	3.503937
90	3.543307
91	3.582677
92	3.622047
93	3.661417
94	3.700787
95	3.740157
96	3.779528
97	3.818898
98	3.858268
99	3.897638
100	3.937008

Area

1 square inch	=	6.452 square centimeters
1 square foot	=	0.093 square meter
1 square yard	=	0.836 square meter
1 acre	=	0.405 hectare
1 square mile	=	2.59 square kilometers
1 square kilometer	=	0.386 square mile
1 hectare	=	2.471 acres
1 square meter	=	1.196 square yards

Length

1 inch	=	2.54 centimeters
1 foot	=	0.305 meter
1 yard	=	0.914 meter
1 mile	=	1.609 kilometers
1 nautical mile	=	1.151 statute miles
1 nautical mile	=	1.852 kilometers
1 meter	=	1.094 yards
1 kilometer	=	0.621 mile

Weight

1 ounce	=	28.35 grams
1 pound	=	0.454 kilogram
1 long ton	=	1.016 metric tons
1 gram	=	0.035 ounce
1 kilogram	=	2.205 pounds

Volume

1 cubic inch	=	16.387 cubic cm
1 cubic foot	=	0.028 cubic meter
1 cubic yard	=	0.765 cubic meter
1 cubic meter	=	1.308 cubic yards

California

1959 East Cashdan Street, Rancho Dominguez, CA 90220
(310) 609-1811 • (800) 326-0006 • FAX: (310) 609-1862

E-Mail: salesrd@std-wire.com

Arizona

3120 West Thomas Road, Bldg. #801, Phoenix, AZ 85017
(602) 269-2501 • (800) 325-6478 • FAX: (602) 278-7134

E-Mail: salesphx@std-wire.com



Standard Wire & Cable Co.

Shrink Tube Usage Requirement Table

Length		Length Required per 1000 Pieces		Yield - No. of Pieces in 1000	
(in)	(mm)	(ft)	(m)	(ft)	(m)
1/8	3.2	10.5	3.20	96,000	314,961
3/16	4.8	15.7	4.79	64,000	209,974
1/4	6.4	20.9	6.37	48,000	157,480
5/16	7.9	26.1	7.96	38,400	125,984
3/8	9.5	31.3	9.54	32,000	104,987
7/16	11.1	36.5	11.1	27,400	89,895
1/2	12.7	41.7	12.7	24,000	78,740
9/16	14.3	46.9	14.3	21,300	69,882
5/8	15.9	52.1	15.9	19,200	62,992
11/16	17.5	57.3	17.5	17,400	57,087
3/4	19.1	62.5	19.1	16,000	52,493
13/16	20.6	67.8	20.7	14,700	48,228
7/8	22.2	73.0	22.3	13,700	44,948
15/16	23.8	78.2	23.8	12,800	41,995
1	25.4	83.4	25.4	12,000	39,370
1 -1/16	27.0	88.6	27.0	11,200	36,745
1-1/8	28.6	93.8	28.6	10,600	34,777
1-3/16	30.2	99.0	30.2	10,100	33,136
1-1/4	31.8	104.2	31.76	9,600	31,496
1-5/16	33.3	109.4	33.35	9,100	29,856
1-3/8	34.9	114.6	34.93	8,700	28,543
1-7/16	36.5	119.8	36.52	8,300	27,231
1-1/2	38.1	125.0	38.10	8,000	26,247
1-9/16	39.7	130.3	39.72	7,600	24,934
1-5/8	41.3	135.5	41.30	7,300	23,950
1-11/16	42.9	140.7	42.89	7,100	23,294
1-3/4	44.5	145.9	44.47	6,800	22,310
1-13/16	46.0	151.1	46.06	6,600	21,654
1-7/8	47.6	156.3	47.64	6,400	20,997
1-15/16	49.2	161.5	49.23	6,100	20,013
2	50.8	166.7	50.81	6,000	19,685
2-1/16	52.4	171.9	52.40	5,800	19,029
2-1/8	54.0	177.1	53.98	5,600	18,373
2-3/16	55.6	182.3	55.57	5,400	17,717
2-1/4	57.2	187.5	57.15	5,300	17,388
2-5/16	58.7	192.8	58.77	5,100	16,732
2-3/8	60.3	198.0	60.35	5,000	16,404
2-7/16	61.9	203.2	61.94	4,900	16,076
2-1/2	63.5	208.4	63.52	4,800	15,748

Length		Length Required per 1000 Pieces		Yield - No. of Pieces in 1000	
(in)	(mm)	(ft)	(m)	(ft)	(m)
2-9/16	65.1	213.6	65.11	4,600	15,092
2-5/8	66.7	218.8	66.69	4,500	14,764
2-11/16	68.3	224.0	68.28	4,400	14,436
2-3/4	69.9	229.2	69.86	4,300	14,108
2-13/16	71.4	234.4	71.45	4,200	13,780
2-7/8	73.0	239.6	73.03	4,100	13,451
2-15/16	74.6	244.8	74.62	4,000	13,123
3	76.2	250.0	76.20	4,000	13,123
3-1/16	77.8	255.3	77.82	3,900	12,795
3-1/8	79.4	260.5	79.40	3,800	12,467
3-3/16	81.0	265.7	80.99	3,700	12,139
3-1/4	82.6	270.9	82.57	3,600	11,811
3-5/16	84.1	276.1	84.16	3,600	11,811
3-3/8	85.7	281.3	85.74	3,500	11,483
3-7/16	87.3	286.5	87.33	3,400	11,155
3-1/2	88.9	291.7	88.91	3,400	11,155
3-9/16	90.5	296.9	90.50	3,300	10,827
3-5/8	92.1	302.1	92.08	3,300	10,827
3-11/16	93.7	307.3	93.67	3,200	10,499
3-3/4	95.3	312.5	95.25	3,200	10,499
3-13/16	96.8	317.8	96.87	3,100	10,171
3-7/8	98.4	323.0	98.45	3,000	9,843
3-15/16	100.0	328.2	100.0	3,000	9,843
4	101.6	333.4	101.6	3,000	9,843
4-1/16	103.2	338.6	103.2	2,900	9,514
4-1/8	104.8	343.8	104.8	2,900	9,514
4-3/16	106.4	349.0	106.4	2,800	9,186
4-1/4	108.0	354.2	108.0	2,800	9,186
4-5/16	109.5	359.4	109.5	2,780	9,121
4-3/8	111.1	364.6	111.1	2,740	8,990
4-7/16	112.7	369.8	112.7	2,700	8,858
4-1/2	114.3	375.0	114.3	2,660	8,727
4-9/16	115.9	380.3	115.9	2,630	8,629
4-5/8	117.5	385.5	117.5	2,590	8,497
4-11/16	119.1	390.7	119.1	2,560	8,399
4-3/4	120.7	395.9	120.7	2,520	8,268
4-13/16	122.2	401.1	122.3	2,490	8,169
4-7/8	123.8	406.3	123.8	2,460	8,071
4-15/16	125.4	411.5	125.4	2,430	7,972

Length		Length Required per 1000 Pieces		Yield - No. of Pieces in 1000	
(in)	(mm)	(ft)	(m)	(ft)	(m)
5	127.0	416.7	127.0	2,400	7,874
5-1/16	128.6	421.9	128.6	2,370	7,776
5-1/8	130.2	427.1	130.2	2,340	7,677
5-3/16	131.8	432.3	131.8	2,310	7,579
5-1/4	133.4	437.5	133.4	2,280	7,480
5-5/16	134.9	442.8	135.0	2,250	7,382
5-3/8	136.5	448.0	136.6	2,230	7,316
5-7/16	138.1	453.2	138.1	2,200	7,218
5-1/2	139.7	458.4	139.7	2,180	7,152
5-9/16	141.3	463.6	141.3	2,150	7,054
5-5/8	142.9	468.8	142.9	2,130	6,988
5-11/16	144.5	474.0	144.5	2,100	6,890
5-3/4	146.1	479.2	146.1	2,080	6,824
5-13/16	147.6	484.4	147.6	2,060	6,759
5-7/8	149.2	489.6	149.2	2,040	6,693
5-15/16	150.8	494.8	150.8	2,020	6,627
6	152.4	500.0	152.4	2,000	6,562
6-1/16	154.0	505.3	154.0	1,970	6,463
6-1/8	155.6	510.5	155.6	1,950	6,398
6-3/16	157.2	515.7	157.2	1,930	6,332
6-1/4	158.8	520.9	158.8	1,920	6,299
6-5/16	160.3	526.1	160.4	1,900	6,234
6-3/8	161.9	531.3	161.9	1,880	6,168
6-7/16	163.5	536.5	163.5	1,860	6,102
6-1/2	165.1	541.7	165.1	1,840	6,037
6-9/16	166.7	546.9	166.7	1,820	5,971
6-5/8	168.3	552.1	168.3	1,810	5,938
6-11/16	169.9	557.3	169.9	1,790	5,873
6-3/4	171.5	562.5	171.5	1,770	5,807
6-13/16	173.0	567.8	173.1	1,760	5,774
6-7/8	174.6	573.0	174.7	1,740	5,709
6-15/16	176.2	578.2	176.2	1,720	5,643
7	177.8	583.4	177.8	1,710	5,610
7-1/16	179.4	588.6	179.4	1,690	5,545
7-1/8	181.0	593.8	181.0	1,680	5,512
7-3/16	182.6	599.0	182.6	1,660	5,446
7-1/4	184.2	604.2	184.2	1,650	5,413
7-5/16	185.7	609.4	185.7	1,640	5,381
7-3/8	187.3	614.6	187.3	1,620	5,315

California

1959 East Cashdan Street, Rancho Dominguez, CA 90220
 (310) 609-1811 • (800) 326-0006 • FAX: (310) 609-1862
 E-Mail: salesrd@std-wire.com

Arizona

3120 West Thomas Road, Bldg. #801, Phoenix, AZ 85017
 (602) 269-2501 • (800) 325-6478 • FAX: (602) 278-7134
 E-Mail: salesphx@std-wire.com



Standard Wire & Cable Co.

Length		Length Required per 1000 Pieces		Yield - No. of Pieces in 1000	
(in)	(mm)	(ft)	(m)	(ft)	(m)
7-7/16	188.9	619.8	188.9	1,610	5,282
7-1/2	190.5	625.0	190.5	1,600	5,249
7-9/16	192.1	630.3	192.1	1,580	5,184
7-5/8	193.7	635.5	193.7	1,570	5,151
7-11/16	195.3	640.7	195.3	1,560	5,118
7-3/4	196.9	645.9	196.9	1,540	5,052
7-13/16	198.4	651.1	198.5	1,530	5,020
7-7/8	200.0	656.3	200.0	1,520	4,987
7-15/16	201.6	661.5	201.6	1,510	4,954
8	203.2	666.7	203.2	1,500	4,921
8-1/16	204.8	671.9	204.8	1,480	4,856
8-1/8	206.4	677.1	206.4	1,470	4,823
8-3/16	208.0	682.3	208.0	1,460	4,790
8-1/4	209.6	687.5	209.6	1,450	4,757
8-5/16	211.1	692.8	211.2	1,440	4,724
8-3/8	212.7	698.0	212.8	1,430	4,692
8-7/16	214.3	703.2	214.3	1,420	4,659
8-1/2	215.9	708.4	215.9	1,410	4,626
8-9/16	217.5	713.6	217.5	1,400	4,593
8-5/8	219.1	718.8	219.1	1,390	4,560
8-11/16	220.7	724.0	220.7	1,380	4,528
8-3/4	222.3	729.2	222.3	1,370	4,495
8-13/16	223.8	734.4	223.8	1,360	4,462
8-7/8	225.4	739.6	225.4	1,350	4,429
8-15/16	227.0	744.8	227.0	1,340	4,396
9	228.6	750.0	228.6	1,330	4,364
9-1/16	230.2	755.3	230.2	1,320	4,331
9-1/8	231.8	760.5	231.8	1,310	4,298
9-3/16	233.4	765.7	233.4	1,300	4,265
9-1/4	235.0	770.9	235.0	1,290	4,232
9-5/16	236.5	776.1	236.6	1,280	4,199
9-3/8	238.1	781.3	238.1	1,280	4,199
9-7/16	239.7	786.5	239.7	1,270	4,167
9-1/2	241.3	791.7	241.3	1,260	4,134
9-9/16	242.9	796.9	242.9	1,250	4,101
9-5/8	244.5	802.1	244.5	1,240	4,068
9-11/16	246.1	807.3	246.1	1,230	4,035
9-3/4	247.7	812.5	247.7	1,230	4,035
9-13/16	249.2	817.8	249.3	1,220	4,003

Length		Length Required per 1000 Pieces		Yield - No. of Pieces in 1000	
(in)	(mm)	(ft)	(m)	(ft)	(m)
9-7/8	250.8	823.0	250.9	1,210	3,970
9-15/16	252.4	828.2	252.4	1,200	3,937
10	254.0	833.4	254.0	1,200	3,937
10-1/16	255.6	838.6	255.6	1,190	3,904
10-1/8	257.2	843.8	257.2	1,180	3,871
10-3/16	258.8	849.0	258.8	1,170	3,839
10-1/4	260.4	854.2	260.4	1,170	3,839
10-5/16	261.9	859.4	261.9	1,160	3,806
10-3/8	263.5	864.6	263.5	1,150	3,773
10-7/16	265.1	869.8	265.1	1,140	3,740
10-1/2	266.7	875.0	266.7	1,140	3,740
10-9/16	268.3	880.3	268.3	1,130	3,707
10-5/8	269.9	885.5	269.9	1,120	3,675
10-11/16	271.5	890.7	271.5	1,120	3,675
10-3/4	273.1	895.9	273.1	1,110	3,642
10-13/16	274.6	901.1	274.7	1,100	3,609
10-7/8	276.2	906.3	276.2	1,100	3,609
10-15/16	277.8	911.5	277.8	1,090	3,576
11	279.4	916.7	279.4	1,090	3,576
11-1/16	281.0	921.9	281.0	1,080	3,543
11-1/8	282.6	927.1	282.6	1,070	3,510
11-3/16	284.2	932.3	284.2	1,070	3,510
11-1/4	285.8	937.5	285.8	1,060	3,478
11-5/16	287.3	942.8	287.4	1,060	3,478
11-3/8	288.9	948.0	289.0	1,050	3,445
11-7/16	290.5	953.2	290.5	1,040	3,412
11-1/2	292.1	958.4	292.1	1,040	3,412
11-9/16	293.7	963.6	293.7	1,030	3,379
11-5/8	295.3	968.8	295.3	1,030	3,379
11-11/16	296.9	974.0	296.9	1,020	3,346
11-3/4	298.5	979.2	298.5	1,020	3,346
11-13/16	300.0	984.4	300.0	1,010	3,314
11-7/8	301.6	989.6	301.6	1,010	3,314
11-15/16	303.2	994.8	303.2	1,000	3,281
12	304.8	1000.0	304.8	1,000	3,281

California

1959 East Cashdan Street, Rancho Dominguez, CA 90220
 (310) 609-1811 • (800) 326-0006 • FAX: (310) 609-1862
 E-Mail: salesrd@std-wire.com

Arizona

3120 West Thomas Road, Bldg. #801, Phoenix, AZ 85017
 (602) 269-2501 • (800) 325-6478 • FAX: (602) 278-7134
 E-Mail: salesphx@std-wire.com



Standard Wire & Cable Co.

Cable and Hose Clamps

Clamps are injection molded in nylon or extruded in PVC. Various colors (white, black, gray, and natural) are available depending on the base material. Operating temperature is -40°C to 66°C. Many feature an adhesive backing.

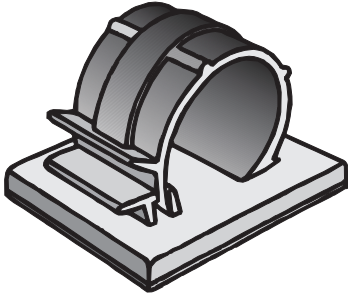

Adhesive Cable Clamp

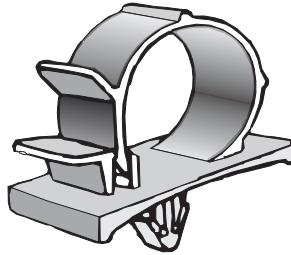

Push Mount Cable Clamp

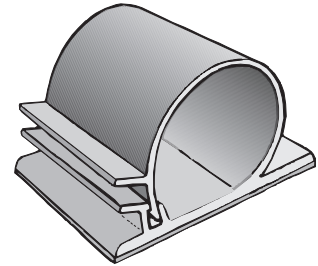

Adhesive Cable Clamp

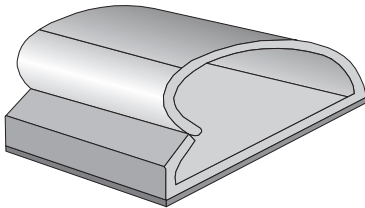

Adhesive Cable Clamp

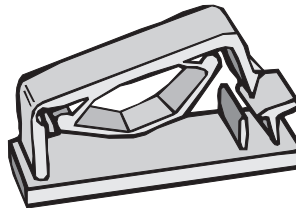

Adhesive Ribbon Cable Clamp

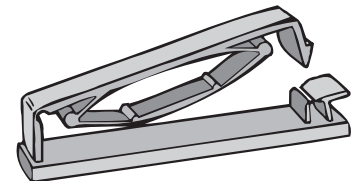

Adhesive Ribbon Cable Clamp

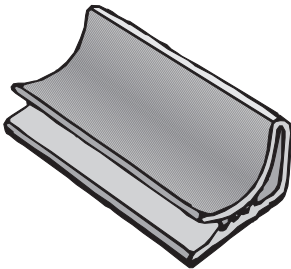

Adhesive Cable Clip

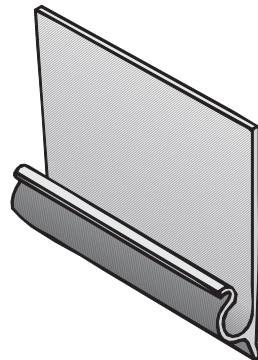

Coax Cable Clip

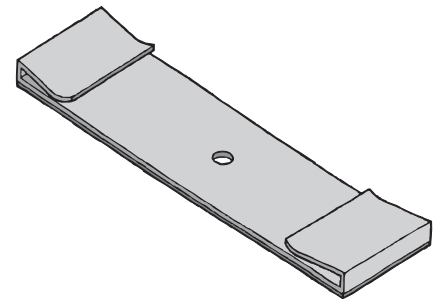

Ribbon Cable Clip

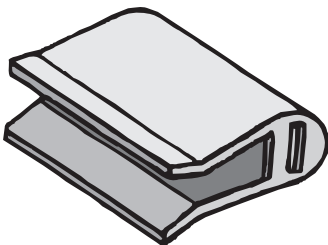

Cable Clip

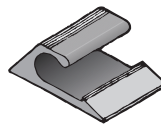

Siding Clip



Snapper Hose Clamp

California

1959 East Cashdan Street, Rancho Dominguez, CA 90220
(310) 609-1811 • (800) 326-0006 • FAX: (310) 609-1862
E-Mail: salesrd@std-wire.com

Arizona

3120 West Thomas Road, Bldg. #801, Phoenix, AZ 85017
(602) 269-2501 • (800) 325-6478 • FAX: (602) 278-7134
E-Mail: salesphx@std-wire.com



Latch Duct

Latch duct is a one-piece PVC extrusion designed to contain, route, and protect wire and cable when it is not feasible to run it inside the wall. Latch duct features a special flexible hinge which allows numerous openings and closings without creating discoloration or stress cracking. The self-locking, hidden positive latch allows for quick reentry as well as secure installation of wire and cable. Adhesive backed with foam tape allows quick installation and high bond strength. Available in sizes 3/4", 1-1/4", and 1-3/4" with a full range of fittings and accessories. Latch duct features an aesthetic, low-profile design that is easy to cut and trim and is paintable with latex-based paint. Ivory is standard color. White is available upon request.

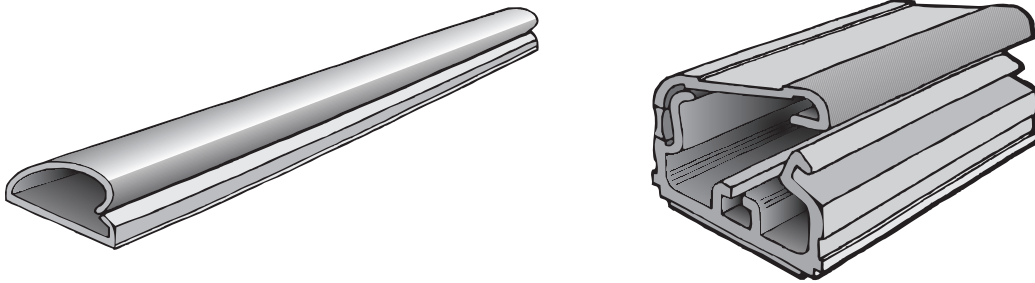

Wiring Duct

Wiring duct is manufactured from a high impact, rigid PVC. The standard colors are gray and white. Also available in black, brown, and beige. Two configurations are available: Solid wall duct for straight wire runs where no break-outs are required and slotted wall duct featuring breakaway fingers providing for additional access for wire leads. The easily snap on and off covers provide a nonslip plastic lining to ensure that covers remain in place under vibration. The covers are designed to be flush with the side of the duct allowing for tight side by side placement. Wiring ducts are available with optional pressure sensitive rubber based adhesive.

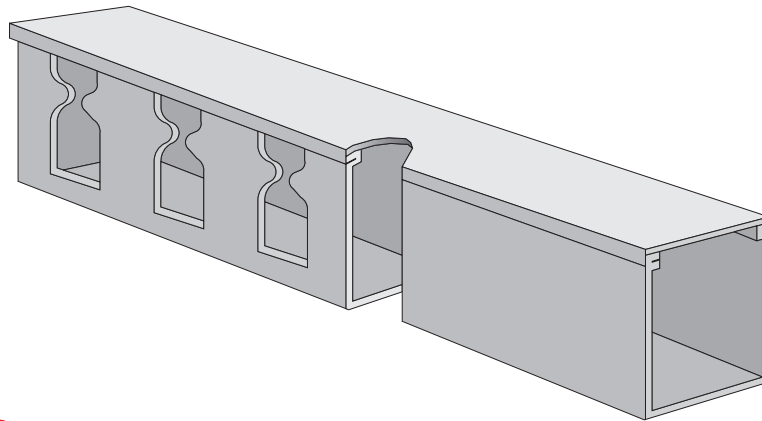

Spiralwrap

Spiralwrap protective sheathing allows flexible routing and lead-out of cables. Spiralwrap is reusable and resistant to most chemicals, including aircraft fuels and hydraulic oils. Packaged on 100 ft. reels.

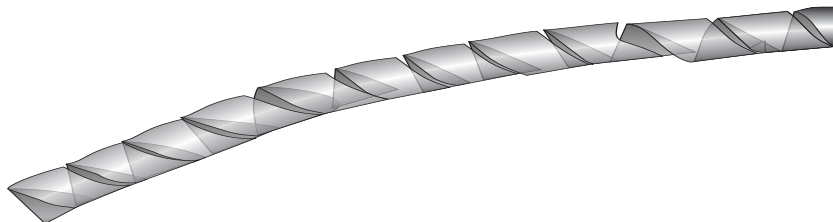

California

1959 East Cashdan Street, Rancho Dominguez, CA 90220
(310) 609-1811 • (800) 326-0006 • FAX: (310) 609-1862
E-Mail: salesrd@std-wire.com

Arizona

3120 West Thomas Road, Bldg. #801, Phoenix, AZ 85017
(602) 269-2501 • (800) 325-6478 • FAX: (602) 278-7134
E-Mail: salesphx@std-wire.com



Standard Wire & Cable Co.

Fiber Optic Duct

This PVC duct system is designed specifically for fiber optic applications. All connectors provide a 2" bend radius which ensures effective signal transmission while utilizing space. Connectors contain inside flange for cable retention during cover removal. Quick release Velcro® cover attachment provides fast and easy re-entry into the system. Over 35 components in different sizes with various horizontal and vertical transitions are available. Standard color is gray.

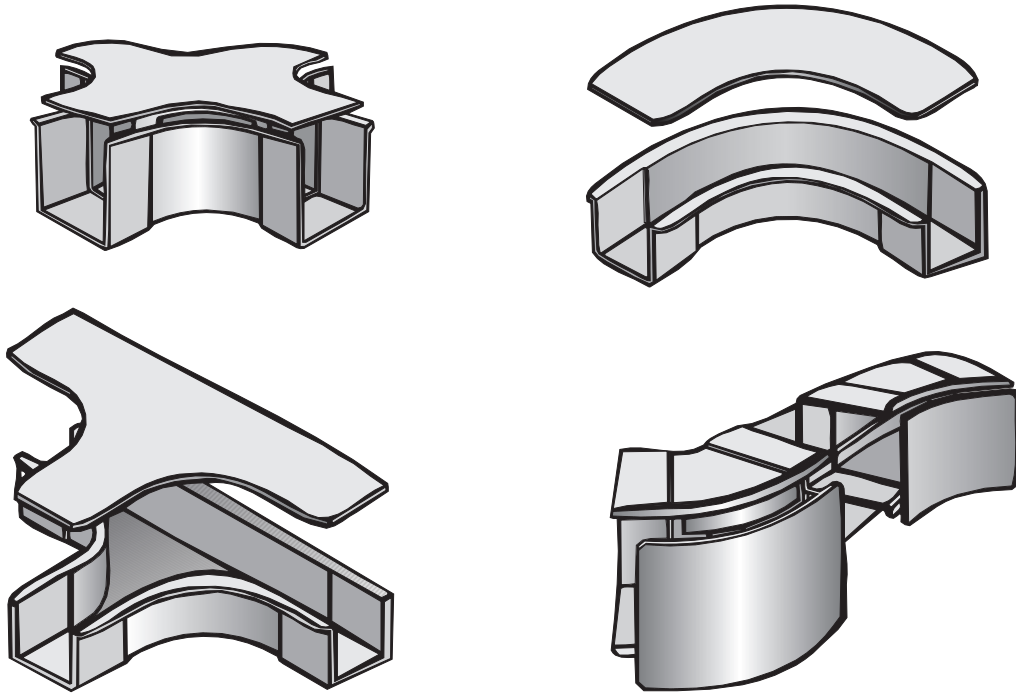

Cable Ties

Standard Wire & Cable Co. has a full line of cable ties in a wide variety of colors, materials, styles, and sizes. Our cable ties are engineered and manufactured for maximum performance and quality. We have cable ties that conform to military, Federal ASTM, and FDA specifications. We have cable ties made of nylon 6/6, nylon 6/6 heat stabilized, nylon 6/6 UV stabilized, nylon 6/6 flame retardant, nylon 6/6 high impact, nylon 12 UV stabilized, polypropylene, polypropylene UV stabilized, Tefzel® and Halar®.

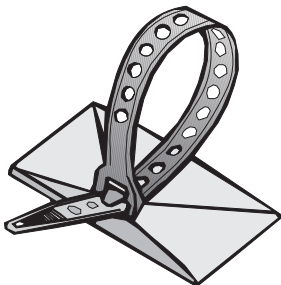

Adhesive Cable Tie Mount



Mounting Cable Ties



Standard Cable Ties

Velcro® is a trademark of Velcro Industries B.V.

Tefzel® is a trademark of the DuPont de Nemours Co.

Halar® is a trademark of the Allied Chemical Co.

California

1959 East Cashdan Street, Rancho Dominguez, CA 90220
(310) 609-1811 • (800) 326-0006 • FAX: (310) 609-1862
E-Mail: salesrd@std-wire.com

Arizona

3120 West Thomas Road, Bldg. #801, Phoenix, AZ 85017
(602) 269-2501 • (800) 325-6478 • FAX: (602) 278-7134
E-Mail: salesphx@std-wire.com



FIBER OPTIC CABLE

THEORY AND CONSTRUCTION

The major benefit of fiber optics over its alternatives is superior transmission capacity, or bandwidth. One optical fiber can carry almost 375 times as much voice and data as high capacity, high-speed T-1 communication lines. Fibers of ultrapure glass carry voice, video, and data signals faster than electron-based copper or coaxial cabling. AT&T Bell Laboratories has tested a system that enables transmission at 4 billion bits per second.

Fiber cabling also surpasses conventional electronic wiring systems for transmitting signals over long distances. Signals on electronic cabling must be retransmitted every mile or so by repeaters. Fiber optic links can carry unrepeatable signals great distances. Experimental systems have sent signals via fiber up to 125 miles without the aid of repeaters.

Another advantage of optical fiber is phenomenally low error rates. Typically, only one in 100 billion bits of information transmitted by fiber optic cabling is faulty as compared with one in 10 billion bits for the next best medium, broadband coaxial cabling.

Fiber optic transmission is not sensitive to electromagnetic interference as are electron based systems.

Fiber optic cabling has the advantage over conventional circuitry for protecting sensitive information against electronic meddling. Even without direct physical contact, it's possible for monitoring devices to pick up signals from the electromagnetic field that surrounds coaxial or copper cabling. Light signals cannot be tapped electromagnetically and fiber optic cabling is virtually impossible to tap.

SYSTEMS COMPONENTS

Like any communication system, a fiber optic link includes a transmitter, a transmission medium, and a receiver. Fiber optic links are designed to accept input and produce output in standard electronic formats but inside the fiber optic system, the signal is transmitted in the form of light.

The light source within the transmitter is a semiconductor laser or light-emitting diode. Electronic circuits within the transmitter convert the input signal

into a bias current which drives the laser or LED. When current exceeds a threshold value, which depends on the individual device, the semiconductor junction emits light with intensity dependent on how much larger the current is than the threshold level. The result is a straightforward amplitude modulation applied by the bias current to a carrier wave with frequency around 300,000 gigahertz. Laboratory transmitters based on semiconductor lasers have operated in the gigahertz or gigabits-per-second range, but only a handful of commercial systems operate above 100 megahertz or 100 megabits-per-second. LED's generally operate at lower speeds than lasers.

At the end of the fiber, the light from the laser or LED is changed back into an electrical signal by a photodetector, a semiconductor device which generates a current when light illuminates a junction. A variety of photodetectors are available, with wavelength response dependent on composition of the semiconductor, and response speed and amplitude dependent on device structure. Electrical output of a photodetector generally requires amplification and often needs some form of "cleaning up" before the signal can be passed on by the fiber optic system. This processing and amplification is the job of the receiver electronics. Fiber optic light sources and detectors can operate in either analog or digital mode and over a range of speeds.

Light is carried from the transmitter to the receiver through an optical fiber, which confines light to a central core, described in more detail below. Because a waveguiding effect is involved, optical fibers are sometimes called optical waveguides, a term which sometimes is applied to thin-film planar waveguides.

In telecommunication systems, the ends of separate fibers are usually spliced together permanently, either by melting ("fusion" splicing) or by gluing with epoxy. In many other fiber optic system, connectors are factory-mounted on fiber ends, then mated together in the field to join the fibers. Splices offer lower loss and are inexpensive, but connectors are needed when the system configuration is subject to change.

California

1959 East Cashdan Street, Rancho Dominguez, CA 90220
(310) 609-1811 • (800) 326-0006 • FAX: (310) 609-1862
E-Mail: salesrd@std-wire.com

Arizona

3120 West Thomas Road, Bldg. #801, Phoenix, AZ 85017
(602) 269-2501 • (800) 325-6478 • FAX: (602) 278-7134
E-Mail: salesphx@std-wire.com



FUNDAMENTAL PRINCIPLE

The fundamental principle underlying the operation of optical fibers is total internal reflection. Internal reflection may occur when light traveling in a material strikes the boundary of another material with a lower refractive index. The angle at which internal reflection will occur is dependent upon the difference of refractive indices of the two materials.

Optical fibers are designed with a circular core region surrounded by a concentric cladding layer with the index of refraction of the core slightly higher than that of the cladding. The refractive index difference determines the acceptance angle of the fiber (numerical aperture). Optical energy entering the fiber core within this acceptance angle will propagate within the core region. The fibers employ a glass core and glass cladding with various materials added to provide the required refractive index variation.

FIBER TYPES

There are three basic types of fiber which can be used in communication systems: Multi-mode step-index, multi-mode graded-index, and single-mode.

MULTI-MODE STEP-INDEX:

The light carrying core of this fiber is surrounded by a cladding of glass with a lower refractive index. There is a discontinuity of "step" in the refractive index at the core-cladding boundary, hence the name. If light in the core hits this boundary at a glancing angle, it is totally reflected back into the core. This mechanism, known as total internal reflection, is what guides the light along the core of a step-index fiber.

In multi-mode fibers, the core is typically tens of micrometers to one millimeter in diameter. Light rays can take many different paths through such cores and these paths may differ significantly in length. The difference in path length causes pulses of light to spread out as they travel along a fiber and, thereby, reduce the bandwidth of the fiber. The pulse-spreading effect gets worse as core diameter increases, leading to a trade-off with light-collection capability and ease of connection, both of which increase with core diameter.

SINGLE-MODE:

If the core diameter of step-index fiber is reduced to a few micrometers, the number of different paths a

light wave can take is effectively reduced to one. This is best seen from the standpoint of waveguide theory, which indicates that such a fiber can support only one mode; hence, the name single-mode. This effectively eliminates pulse dispersion due to path-length differences and as a result, single-mode fibers have the broadest bandwidth of any type. In practice, other effects limit bandwidth, but only become significant at frequencies well into the gigahertz range. Unfortunately, the small core diameter of single-mode fibers makes it hard to transfer light into such fibers from light sources or other types of fiber, a very serious problem in practical communication systems.

MULTI-MODE GRADED-INDEX:

It's possible to combine broad bandwidth with good light-collecting capability by using a different type of fiber structure -- the graded-index fiber. In this type, the boundary between core and cladding is not abrupt but gradual, so the change in refractive index with distance from the center of the fiber is not a sharp step but a gradual slope. Light trying to pass from the core through this graded region at a low enough angle is gradually bent back toward the core rather than abruptly reflected. If the refractive index profile is properly adjusted, light rays traveling different paths through a graded-index fiber will travel nearly the same distance, minimizing pulse spreading and increasing bandwidth. Of necessity, the manufacturing of graded-index fibers is a somewhat more complex task than production of step-index fibers, but graded-index fiber has major advantages and is mass-producible. Graded-index fiber is used in virtually all long-distance fiber optic links for commercial telecommunications.

CABLE CONSTRUCTION CONSIDERATIONS

If fibers are not stressed, their mechanical and optical properties remain unchanged for typical lifetimes of 20 to 40 years, even in the presence of humidity, water, and strongly acid and basic chemicals.

Fibers that are stressed due to tension or sharp bending (macro-bending) are fatigued, exhibit loss of strength and may fail, even when the stress is well below screen test levels used at the fiber manufacturing stage. In addition to stress affecting fiber life, stress upon the fiber also can produce micro-bending, or microscopic fiber bends, which will increase the signal loss of the fiber.

California

1959 East Cashdan Street, Rancho Dominguez, CA 90220
(310) 609-1811 • (800) 326-0006 • FAX: (310) 609-1862
E-Mail: salesrd@std-wire.com

Arizona

3120 West Thomas Road, Bldg. #801, Phoenix, AZ 85017
(602) 269-2501 • (800) 325-6478 • FAX: (602) 278-7134
E-Mail: salesphx@std-wire.com



Standard Wire & Cable Co.

The fiber sensitivity to microbending is a function of the core-cladding diameter ratio, the difference between core and cladding and the primary coating. In order to eliminate added loss due to microbending, the cable structure must isolate the fiber from stress due to both environmental effects, such as temperature and physical properties such as bending, and residual stress due to installation conditions. The cable structure also must restrain the minimum bend radius of the fiber since microbending which occurs below a minimum bend radius will also induce added fiber attenuation.

Traditionally, cable designs have been classified as either tight or loose buffer designs. The design type is differentiated by the protective coating or buffer that is used to facilitate fiber handling during the cabling process.

Tight buffer designs are characterized by application of one or two layers of protective plastic over the primary fiber coating. This may be on an individual fiber basis or in a ribbon structure. The former normally yields a cabling element with an outer diameter of 0.9 to 1 mm and is tightly contained within the cable structure. In ribbon design several fibers, typically 12, are sandwiched in parallel between two tape layers but the ribbon or layers of ribbons normally are allowed to float within the cable structure.

The loose structure is characterized by the fiber or fibers being placed in a cavity whose inner dimensions are much larger than that of the outer diameter of the coated fiber. Common types are slotted core or loose tube design. A variation on the loose tube design is the filled loose tube. This technique uses a viscous fluid which allows for fiber movement and excludes the presence of water.

As a general rule, when optimum environmentally stable transmission characteristics, especially under continuous mechanical stress, are specified, the filled loose buffer will be preferred. If, however, simple and robust designs with small numbers of fibers are required, the tight buffer may be advantageous.

Typically tight buffer designs are more sensitive to low temperature because of the relative large amount of plastic in intimate contact with the fiber. Since the coefficient of thermal expansion for plastic and glass are very dissimilar, the contraction forces at

low temperature of the fiber coating can cause unacceptable added loss. Tight buffering also is more sensitive to added loss during buffering and subsequent cabling operations.

In order to minimize cable elongation and contraction characteristics, structural members are included in many cable designs. The structural center member is normally steel or epoxy fiberglass, as a core foundation, around which the buffered fibers are stranded and act as an antibuckling element. Typically, a layer of Kelvar® is placed over the cable core to serve as the primary cable load-bearing element.

The table below describes representative cable performance and should be used as a guideline for system design.

TYPICAL CABLE TRANSMISSION CHARACTERISTICS			
Operating Wavelength (nanometers)	Attenuation (dB / km)	Bandwidth (MHz / km)	Distance between repeaters for 90 Mbps system (km)
850	2.8 - 4.5	200 - 1,000	12
1,300	0.9 - 2.5	200 - 1,300	22
850 / 1,300	2.8 / 1.5 - 4.5 / 3.0	200 - 800	10* / 12 / 14

TRANSMISSION CONSIDERATIONS

Bandwidth, or information carrying capacity, and attenuation, or loss of power, are the two primary properties of the transmission medium that impact the performance of a fiber optic communications system. Fiber bandwidth is specified normalized to a 1 km length and expressed in units of megahertz per kilometer. Optical characteristics for typical constructions are:

OPTICAL CHARACTERISTICS					
Construction	Glass Type	Code (X)	Operating Wavelength (nanometers)	Minimum Bandwidth (MHz / km)	Maximum Attenuation (db / km)
Loose tube	50 / 125 multi-mode	1	850 / 1,300	400 / 400	3.0 1 / 1.0
Loose tube	62.5 / 125 multi-mode	2	850 / 1,300	160 / 500	3.25 / 1.0
Loose tube	8 / 125 single-mode	3	1,310 / 1,550		0.45 / 0.35
Tight buffered & micro-loose tube	50 / 125 multi-mode	1	850 / 1,300	400 / 400	3.50 / 1.25
Tight buffered & micro-loose tube	62.5 / 125 multi-mode	2	850 / 1,300	160 / 500	3.50 / 1.25
Tight buffered & micro-loose tube	8 / 125 single-mode	3	1,310 / 1,550		0.80 / 0.50

*With wavelength division multiplexing.

Kelvar® is a trademark of the DuPont de Nemours Co.

California

1959 East Cashdan Street, Rancho Dominguez, CA 90220
(310) 609-1811 • (800) 326-0006 • FAX: (310) 609-1862
E-Mail: salesrd@std-wire.com

Arizona

3120 West Thomas Road, Bldg. #801, Phoenix, AZ 85017
(602) 269-2501 • (800) 325-6478 • FAX: (602) 278-7134
E-Mail: salesphx@std-wire.com



Standard Wire & Cable Co.

Simplex & Duplex Cables

UL Type OFNR

UL Type OFNP

2.8mm Diameter

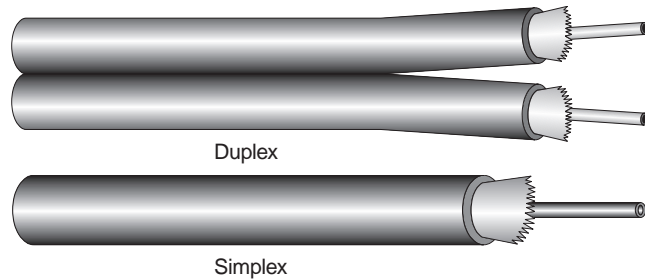

MECHANICAL, ENVIRONMENTAL & FLAME CHARACTERISTICS:

Crush Resistance	EIA-455-41	200 Newtons/cm
Impact Resistance	EIA-455-25	20 Impacts with 1.0 newton-meter
Flexure	EIA-455-104	100 Cycles minimum
Minimum Bend Radius	Long-term - No Load	10 x Cable diameter
Minimum Bend Radius	Short-term - Load	15 x Cable diameter
Operating Temperature		-20° C to 70° C
Storage Temperature		-40° C to 70° C
UL Rated	Type OFNR	Riser
UL Rated	Type OFNP	Plenum

USES: Patch cables, short run office wiring, computer room wiring.

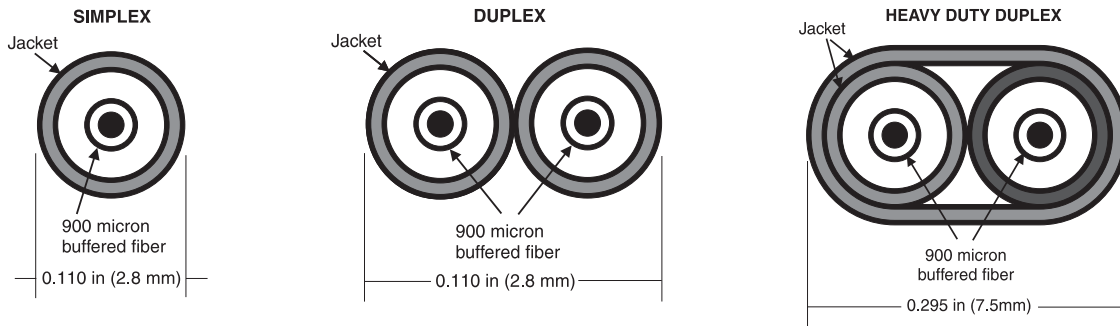

Riser

Part Number	Fiber Count	Weight		Minimum Bend Radius				Maximum Load (Installation)	
		(lbs / 1000 ft)	(kgs / km)	Short-term (in)	Short-term (cm)	Long-term (in)	Long-term (cm)	(lbs)	(newtons)
M9X001	1	6	8.93	1.7	4.32	1.1	2.79	77	343
M9X002	2	10	14.9	1.7	4.32	1.1	2.79	154	685
M9X080	2	25	37.2	1.7	4.32	1.1	2.79	154	685

Plenum

Part Number	Fiber Count	Weight		Minimum Bend Radius				Maximum Load (Installation)	
		(lbs / 1000 ft)	(kgs / km)	Short-term (in)	Short-term (cm)	Long-term (in)	Long-term (cm)	(lbs)	(newtons)
M9X003	1	7	10.4	1.7	4.32	1.1	2.79	77	343
M9X004	2	15	22.3	1.7	4.32	1.1	2.79	154	685
M9X081	2	30	44.6	1.7	4.32	1.1	2.79	154	685

For "X" in part number, see optical characteristics chart on page 186.

California

1959 East Cashdan Street, Rancho Dominguez, CA 90220
 (310) 609-1811 • (800) 326-0006 • FAX: (310) 609-1862
 E-Mail: salesrd@std-wire.com

Arizona

3120 West Thomas Road, Bldg. #801, Phoenix, AZ 85017
 (602) 269-2501 • (800) 325-6478 • FAX: (602) 278-7134
 E-Mail: salesphx@std-wire.com



Distribution Cables

UL Type OFNR

Riser

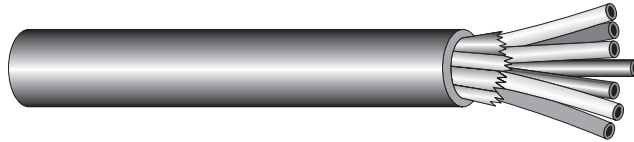

MECHANICAL, ENVIROMENTAL, & FLAME CHARACTERISTICS:

Crush Resistance	EIA-455-41	2,000 Newtons/cm
Impact Resistance	EIA-455-25	2,000 Impacts with 1.6 newton-meter
Flexure	EIA-455-104	2,000 Cycles minimum
Minimum Bend Radius	Long-term - No Load	10 x Cable diameter
Minimum Bend Radius	Short-term - Load	15 x Cable diameter
Operating Temperature		-20° C to 70° C
Storage Temperature		-40° C to 80° C
UL Rated	Type OFNR	
Flame Resistance	UL 1666	Passed

USES: Riser wiring, office wiring, and computer room wiring.

PRODUCT FEATURES: 900 µm tight buffered fibers. Color coded for easy termination. Flame-retardant. UL listed for code compliance.

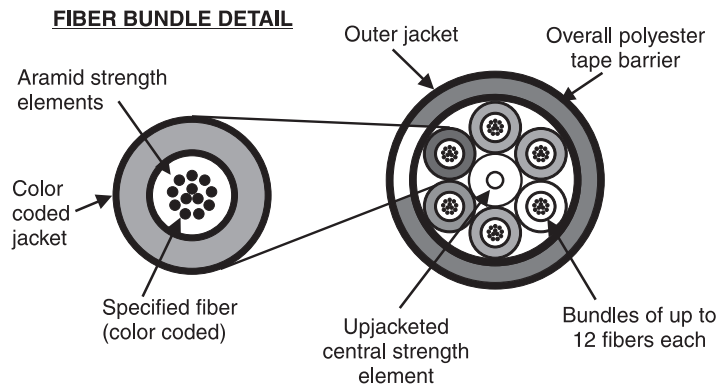

Part Number	Fiber Count	Outside Diameter		Weight		Minimum Bend Radius				Maximum Load (Installation)	
		(in)	(mm)	(lbs / 1000 ft)	(kgs / km)	Short-term		Long-term		(lbs)	(newtons)
M9X037	2	0.184	4.67	15	22.3	2.8	7.1	1.8	4.6	90	400
M9X038	4	0.200	5.08	15	22.3	3.0	7.6	2.0	5.1	120	534
M9X039	6	0.220	5.59	20	29.8	3.3	8.4	2.2	5.6	150	667
M9X040	8	0.242	6.15	25	37.2	3.6	9.1	2.4	6.1	180	801
M9X042	12	0.300	7.62	35	52.1	4.5	11.4	3.0	7.6	240	1,068
M9X600	16	0.528	13.4	100	149	7.90	20.1	5.3	13	720	3,203
M9X602	24	0.528	13.4	110	164	7.90	20.1	5.3	13	1,080	4,804
M9X604	36	0.634	16.1	150	223	9.50	24.1	6.3	16	1,260	5,605
M9X606	48	0.754	19.2	230	342	11.3	28.7	7.5	19	1,440	6,405
M9X609	72	0.754	19.2	260	387	11.3	28.7	7.5	19	1,620	7,206
M9X619	144	1.04	26.4	400	595	15.6	39.6	10.4	26.4	2,500	11,121

For "X" in part number, see optical characteristics chart on page 186.

California

1959 East Cashdan Street, Rancho Dominguez, CA 90220
 (310) 609-1811 • (800) 326-0006 • FAX: (310) 609-1862
 E-Mail: salesrd@std-wire.com

Arizona

3120 West Thomas Road, Bldg. #801, Phoenix, AZ 85017
 (602) 269-2501 • (800) 325-6478 • FAX: (602) 278-7134
 E-Mail: salesphx@std-wire.com



Standard Wire & Cable Co.

Distribution Cables

UL Type OFNP

Plenum

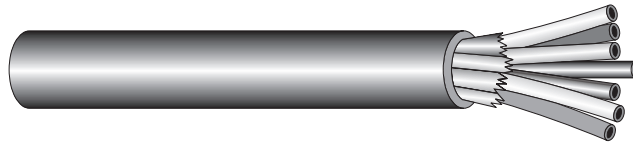

MECHANICAL, ENVIROMENTAL, & FLAME CHARACTERISTICS:

Crush Resistance	EIA-455-41	2,000 Newton/cm
Impact Resistance	EIA-455-25	2,000 Impacts with 1.6 newton-meter
Flexure	EIA-455-104	2,000 Cycles minimum
Minimum Bend Radius	Long-term - No Load	10 x Cable diameter
Minimum Bend Radius	Short-term - Load	15 x Cable diameter
Operating Temperature		-20° C to 70° C
Storage Temperature		-40° C to 80° C
UL Rated	Type OFNP	
Flame Resistance	UL 910 Modified Passed	

USES: Plenum wiring, office wiring, and computer room wiring.

PRODUCT FEATURES: 900 µm tight buffered fibers. Color coded for easy termination. Flame-retardant. UL listed for code compliance.

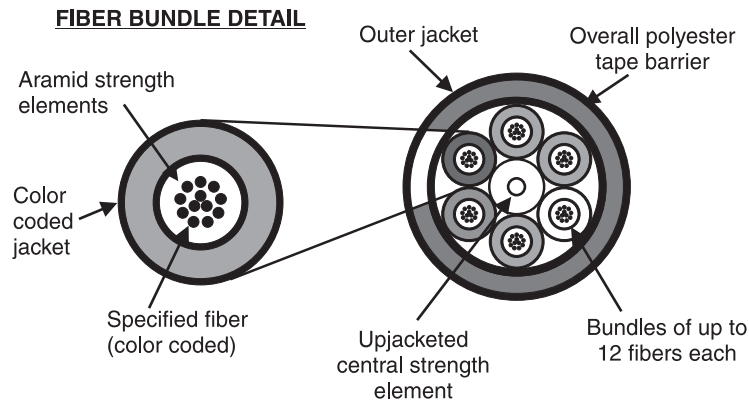

Part Number	Fiber Count	Outside Diameter		Weight		Minimum Bend Radius				Maximum Load (Installation)	
		(in)	(mm)	(lbs / 1000 ft)	(kgs / km)	Short-term		Long-term		(lbs)	(newtons)
						(in)	(cm)	(in)	(cm)		
M9X043	2	0.184	4.67	15	22	2.8	7.1	1.8	4.6	90	400
M9X044	4	0.184	4.67	15	22	2.8	7.1	1.8	4.6	120	534
M9X045	6	0.200	5.08	20	30	3.0	7.6	2.0	5.1	150	667
M9X046	8	0.222	5.64	25	37	3.3	8.4	2.2	5.6	180	801
M9X048	12	0.270	6.86	30	45	4.1	10	2.7	6.9	240	1,068
M9X610	16	0.508	12.9	105	156	7.6	19	5.1	13	720	3,203
M9X612	24	0.498	12.6	100	149	7.5	19	5.0	13	1,080	4,804
M9X614	36	0.614	15.6	180	268	9.2	23	6.1	15	1,260	5,605
M9X616	48	0.734	18.6	210	312	11.0	27.9	7.3	19	1,440	6,405
M9X620	72	0.737	18.7	220	327	11.0	27.9	7.3	19	1,620	7,206

For "X" in part number, see optical characteristics chart on page 186.

California

1959 East Cashdan Street, Rancho Dominguez, CA 90220
(310) 609-1811 • (800) 326-0006 • FAX: (310) 609-1862
E-Mail: salesrd@std-wire.com

Arizona

3120 West Thomas Road, Bldg. #801, Phoenix, AZ 85017
(602) 269-2501 • (800) 325-6478 • FAX: (602) 278-7134
E-Mail: salesphx@std-wire.com



Standard Wire & Cable Co.

Breakout Cables UL Type OFNP

2.0mm subunit - Plenum

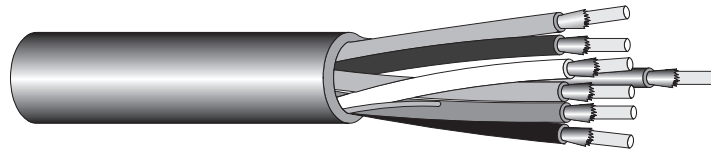

MECHANICAL, ENVIROMENTAL, & FLAME CHARACTERISTICS:

Crush Resistance	EIA-455-41	2,000 Newton/cm
Impact Resistance	EIA-455-25	2,000 Impacts with 1.6 newton-meter
Flexure	EIA-455-104	2,000 Cycles minimum
Minimum Bend Radius	Long-term - No Load	10 x Cable diameter
Minimum Bend Radius	Short-term - Load	15 x Cable diameter
Operating Temperature		-20° C to 70° C
Storage Temperature		-40° C to 80° C
UL Rated	Type OFNP	
Flame Resistance	UL 910 Modified	Passed

USES: Plenum wiring, office wiring, and computer room wiring.

PRODUCT FEATURES: 900 µm tight buffered fibers. Color coded for easy termination. Flame-retardant. UL listed for code compliance. 2-12 fibers per DEC specifications.

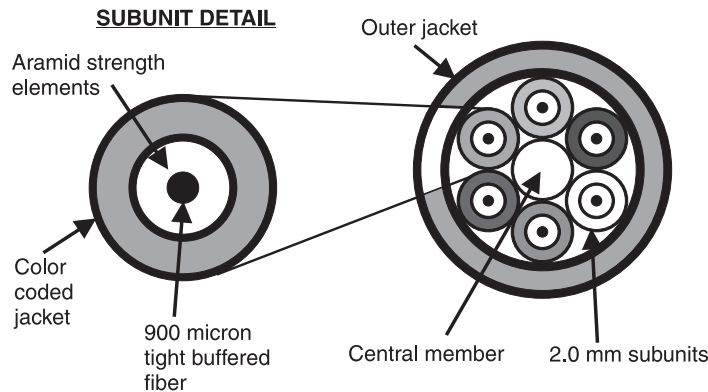

Part Number	Fiber Count	Outside Diameter		Weight		Minimum Bend Radius				Maximum Load (Installation)	
		(in)	(mm)	(lbs / 1000 ft)	(kgs / km)	Short-term		Long-term		(lbs)	(newtons)
M9X013	2	0.191	4.85	20	30	2.9	7	1.9	4.8	224	996
M9X014	4	0.224	5.69	25	37	3.4	9	2.2	5.6	600	2,669
M9X015	6	0.280	7.11	40	60	4.2	11	2.8	7.1	600	2,669
M9X016	8	0.342	8.69	60	89	5.1	13	3.4	8.6	600	2,669
M9X017	10	0.387	9.83	80	119	5.8	15	3.9	9.9	600	2,669
M9X018	12	0.458	11.6	100	149	6.9	18	4.6	12	600	2,669
M9X019	18	0.458	11.6	100	149	6.9	18	4.6	12	600	2,669
M9X020	24	0.558	14.2	145	216	8.4	21	5.6	14	600	2,669
M9X082	36	0.603	15.3	165	246	9.0	23	6.0	15	600	2,669

For "X" in part number, see optical characteristics chart on page 186.

California

1959 East Cashdan Street, Rancho Dominguez, CA 90220
(310) 609-1811 • (800) 326-0006 • FAX: (310) 609-1862
E-Mail: salesrd@std-wire.com

Arizona

3120 West Thomas Road, Bldg. #801, Phoenix, AZ 85017
(602) 269-2501 • (800) 325-6478 • FAX: (602) 278-7134
E-Mail: salesphx@std-wire.com



Standard Wire & Cable Co.

Breakout Cables

UL Type OFNR

2.0mm subunit - Riser

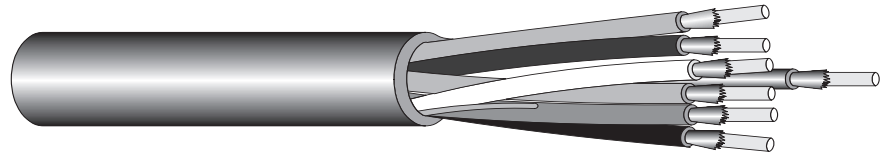

MECHANICAL, ENVIROMENTAL, & FLAME CHARACTERISTICS:

Crush Resistance	EIA-455-41	2,000 Newton/cm
Impact Resistance	EIA-455-25	2,000 Impacts with 1.6 newton-meter
Flexure	EIA-455-104	2,000 Cycles minimum
Minimum Bend Radius	Long-term - No Load	10 x Cable diameter
Minimum Bend Radius	Short-term - Load	15 x Cable diameter
Operating Temperature		-20° C to 70° C
Storage Temperature		-40° C to 80° C
UL Rated	Type OFNR	
Flame Resistance	UL 1666	Passed

USES: Riser wiring (typically under 300 meters), office wiring, and computer room wiring.

PRODUCT FEATURES: 900 µm tight buffered fibers. Color coded for easy termination. Flame-retardant. UL listed for code compliance. Direct connectorization. 2-12 fibers per DEC specifications.

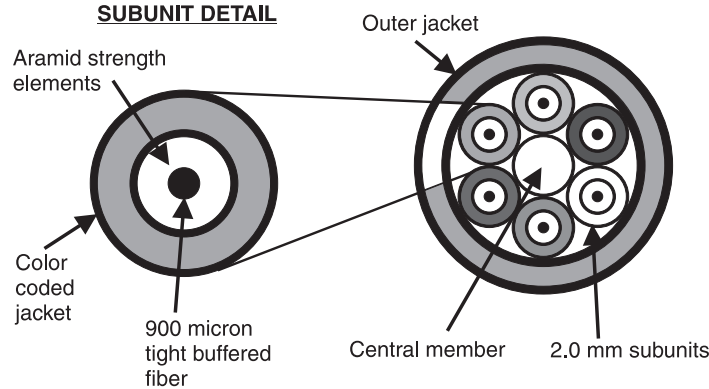

Part Number	Fiber Count	Outside Diameter		Weight		Minimum Bend Radius				Maximum Load (Installation)	
		(in)	(mm)	(lbs / 1000 ft)	(kgs / km)	Short-term		Long-term		(lbs)	(newtons)
M9X005	2	0.280	7.11	20	30	4.2	11	2.8	7.1	224	996
M9X006	4	0.312	7.92	25	37	4.7	12	3.1	7.9	600	2,669
M9X007	6	0.358	9.09	35	52	5.4	14	3.6	9.1	600	2,669
M9X008	8	0.405	10.3	55	82	6.1	15	4.1	10	600	2,669
M9X009	10	0.454	11.5	70	104	6.8	17	4.5	11	600	2,669
M9X010	12	0.514	13.1	115	171	7.7	20	5.1	13	600	2,669
M9X011	18	0.514	13.1	115	171	7.7	20	5.1	13	600	2,669
M9X012	24	0.604	15.3	130	193	9.1	23	6.0	15	600	2,669
M9X083	36	0.680	17.3	175	260	10.2	25.9	6.8	17	600	2,669

For "X" in part number, see optical characteristics chart on page 186.

California

1959 East Cashdan Street, Rancho Dominguez, CA 90220
(310) 609-1811 • (800) 326-0006 • FAX: (310) 609-1862
E-Mail: salesrd@std-wire.com

Arizona

3120 West Thomas Road, Bldg. #801, Phoenix, AZ 85017
(602) 269-2501 • (800) 325-6478 • FAX: (602) 278-7134
E-Mail: salesphx@std-wire.com



Standard Wire & Cable Co.

Loose Tube Cables UL Type OFNR

Outdoor

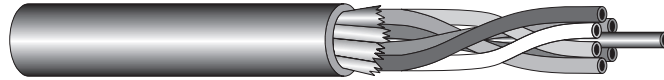

MECHANICAL, ENVIROMENTAL, & FLAME CHARACTERISTICS:

Crush Resistance	EIA-455-41	2,000 Newtons/cm
Impact Resistance	EIA-455-25	2,000 Impacts with 1.6 newton-meter
Flexure	EIA-455-104	2,000 Cycles minimum
Minimum Bend Radius	Long-term - No Load	15 x Cable diameter
Minimum Bend Radius	Short-term - Load	20 x Cable diameter
Operating Temperature		-40° C to 70° C
Storage Temperature		-50° C to 80° C
UL Rated	Type OFNR	
Flame Resistance	UL 1666	Passed

USES: Building interconnections, telecommunications and data trunk, long haul networking, ducts between buildings, and applications requiring good ozone, moisture, and weather resistance.

PRODUCT FEATURES: Available in several fiber counts. All dielectric central strength member. Excellent attenuation performance. Water block gel for moisture protection. Polyethylene jacket for weather and UV protection. Breakout kits available.

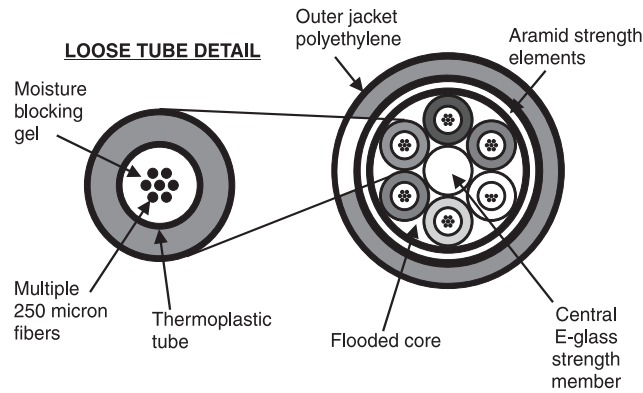

1 Fiber per tube

Part Number	Fiber Count	Outside Diameter		Weight		Minimum Bend Radius				Maximum Load (Installation)	
		(in)	(mm)	(lbs / 1000 ft)	(kgs / km)	Short-term		Long-term		(lbs)	(newtons)
M9X058	2	0.375	9.53	55	82	7.5	19	5.6	14	600	2,669
M9X059	4	0.375	9.53	55	82	7.5	19	5.6	14	600	2,669
M9X060	6	0.375	9.53	55	82	7.5	19	5.6	14	600	2,669
M9X061	8	0.520	13.2	125	186	10.4	26.4	7.8	20	600	2,669
M9X062	12	0.520	13.2	125	186	10.4	26.4	7.8	20	600	2,669

For "X" in part number, see optical characteristics chart on page 186.

California

1959 East Cashdan Street, Rancho Dominguez, CA 90220
(310) 609-1811 • (800) 326-0006 • FAX: (310) 609-1862
E-Mail: salesrd@std-wire.com

Arizona

3120 West Thomas Road, Bldg. #801, Phoenix, AZ 85017
(602) 269-2501 • (800) 325-6478 • FAX: (602) 278-7134
E-Mail: salesphx@std-wire.com



Standard Wire & Cable Co.

2 Fibers per tube

Part Number	Fiber Count	Outside Diameter		Weight		Minimum Bend Radius				Maximum Load (Installation)	
		(in)	(mm)	(lbs / 1000 ft)	(kgs / km)	Short-term		Long-term		(lbs)	(newtons)
M9X063	4	0.375	9.53	55	82	7.5	19	5.6	14	600	2,669
M9X064	6	0.375	9.53	55	82	7.5	19	5.6	14	600	2,669
M9X065	8	0.375	9.53	55	82	7.5	19	5.6	14	600	2,669
M9X066	10	0.375	9.53	55	82	7.5	19	5.6	14	600	2,669
M9X067	12	0.375	9.53	55	82	7.5	19	5.6	14	600	2,669

6 Fibers per tube

Part Number	Fiber Count	Outside Diameter		Weight		Minimum Bend Radius				Maximum Load (Installation)	
		(in)	(mm)	(lbs / 1000 ft)	(kgs / km)	Short-term		Long-term		(lbs)	(newtons)
M9X510	6	0.375	9.53	55	82	7.5	19	5.6	14	600	2,669
M9X511	12	0.375	9.53	55	82	7.5	19	5.6	14	600	2,669
M9X512	18	0.375	9.53	55	82	7.5	19	5.6	14	600	2,669
M9X500	24	0.375	9.53	55	82	7.5	19	5.6	14	600	2,669
M9X501	30	0.375	9.53	55	82	7.5	19	5.6	14	600	2,669
M9X502	36	0.375	9.53	55	82	7.5	19	5.6	14	600	2,669
M9X518	48	0.415	10.5	110	164	8.3	21	6.2	16	600	2,669
M9X503	54	0.520	13.2	125	186	10.4	26.4	7.8	20	600	2,669
M9X519	60	0.520	13.2	125	186	10.4	26.4	7.8	20	600	2,669
M9X504	72	0.520	13.2	125	186	10.4	26.4	7.8	20	600	2,669

12 Fibers per tube

Part Number	Fiber Count	Outside Diameter		Weight		Minimum Bend Radius				Maximum Load (Installation)	
		(in)	(mm)	(lbs / 1000 ft)	(kgs / km)	Short-term		Long-term		(lbs)	(newtons)
M9X515	12	0.475	12.1	95	141	9.5	24	7.1	18	600	2,669
M9X516	24	0.475	12.1	95	141	9.5	24	7.1	18	600	2,669
M9X517	36	0.475	12.1	95	141	9.5	24	7.1	18	600	2,669
M9X505	48	0.475	12.1	95	141	9.5	24	7.1	18	600	2,669
M9X506	60	0.475	12.1	95	141	9.5	24	7.1	18	600	2,669
M9X507	72	0.475	12.1	95	141	9.5	24	7.1	18	600	2,669
M9X513	96	0.542	13.8	150	223	10.8	27.4	8.1	21	600	2,669
M9X508	108	0.695	17.7	250	372	13.9	35.3	10.4	26.4	600	2,669
M9X514	120	0.695	17.7	250	372	13.9	35.3	10.4	26.4	600	2,669
M9X509	144	0.695	17.7	250	372	13.9	35.3	10.4	26.4	600	2,669

For "X" in part number, see optical characteristics chart on page 186.

California

1959 East Cashdan Street, Rancho Dominguez, CA 90220
(310) 609-1811 • (800) 326-0006 • FAX: (310) 609-1862
E-Mail: salesrd@std-wire.com

Arizona

3120 West Thomas Road, Bldg. #801, Phoenix, AZ 85017
(602) 269-2501 • (800) 325-6478 • FAX: (602) 278-7134
E-Mail: salesphx@std-wire.com



Standard Wire & Cable Co.

Loose Tube Cables UL Type OFNR

Indoor/Outdoor

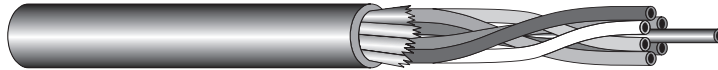

MECHANICAL, ENVIROMENTAL, & FLAME CHARACTERISTICS:

Crush Resistance	EIA-455-41	2,000 Newton/cm
Impact Resistance	EIA-455-25	2,000 Impacts with 1.6 newton-meter
Flexure	EIA-455-104	2,000 Cycles minimum
Minimum Bend Radius	Long-term - No Load	15 x Cable diameter
Minimum Bend Radius	Short-term - Load	20 x Cable diameter
Operating Temperature		-40° C to 70° C
Storage Temperature		-40° C to 80° C
UL Rated	Type OFNR	
Flame Resistance	UL 1666	Passed

USES: Indoor/outdoor installations, telecommunications and data trunk, and building interconnections.

PRODUCT FEATURES: No splicing required at building entrance. Available with zero-halogen jacket. Armored/direct burial versions available. Breakout kits available.

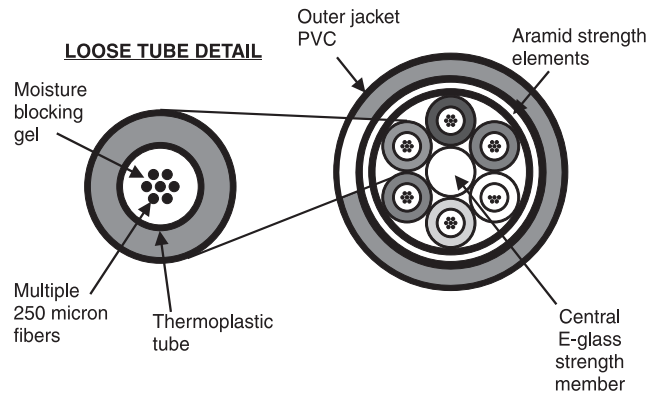

Part Number	Fiber Count	Outside Diameter		Weight		Minimum Bend Radius				Maximum Load (Installation)	
		(in)	(mm)	(lbs / 1000 ft)	(kgs / km)	Short-term		Long-term		(lbs)	(newtons)
M9X810	6	0.375	9.53	73	109	7.5	19	5.6	14	600	2,669
M9X811	12	0.375	9.53	73	109	7.5	19	5.6	14	600	2,669
M9X812	24	0.375	9.53	73	109	7.5	19	5.6	14	600	2,669
M9X813	36	0.375	9.53	73	109	7.5	19	5.6	14	600	2,669
M9X814	48	0.475	12.1	116	173	9.5	24	7.1	18	600	2,669
M9X815	72	0.475	12.1	116	173	9.5	24	7.1	18	600	2,669
M9X816	96	0.542	13.8	172	256	10.8	27.4	8.1	21	600	2,669
M9X817	144	0.695	17.7	287	427	13.9	35.3	10.4	26.4	600	2,669

For "X" in part number, see optical characteristics chart on page 186.

California

1959 East Cashdan Street, Rancho Dominguez, CA 90220
(310) 609-1811 • (800) 326-0006 • FAX: (310) 609-1862
E-Mail: salesrd@std-wire.com

Arizona

3120 West Thomas Road, Bldg. #801, Phoenix, AZ 85017
(602) 269-2501 • (800) 325-6478 • FAX: (602) 278-7134
E-Mail: salesphx@std-wire.com



Standard Wire & Cable Co.

COMPARISON CHART UL WIRES & CABLES

UL STYLE NUMBER	AWG SIZE RANGE	VOLTAGE RATING	TEMP. RATING	INSULATION		REMARKS
				THICKNESS	MATERIAL	
1007	30 - 16	300	80°C	1/64	PVC	Internal wiring of appliances
1009	28 - 16	300	90°C	1/64	PVC	Internal wiring of appliances
1010	28 - 16	300	105°C	1/64	PVC / nylon	Internal wiring of appliances
1011	28 - 9	600	80°C	1/32	PVC	Internal wiring of appliances
1012	28 - 9	600	80°C	1/32	PVC / nylon	Internal wiring of appliances
1013	28 - 9	600	90°C	1/32	PVC	Internal wiring of appliances
1014	28 - 9	600	90°C	1/32	PVC / nylon	Internal wiring of appliances
1015	28 - 9	600	105°C	1/32	PVC	Internal wiring of appliances
1016	28 - 9	600	105°C	1/32	PVC / nylon	Internal wiring of appliances
1024	22 - 8	600	80°C	3/64	PVC	Internal wiring of appliances
1028	22 - 8	600	105°C	3/64	PVC	Internal wiring of appliances
1061	30 - 16	300	80°C	0.009"	Semirigid PVC	Internal wiring of machines
1095	30 - 16	300	80°C	0.012"	PVC	Internal wiring of machines
1096	30 - 16	300	80°C	0.012"	PVC / nylon	Internal wiring of machines
1164	28 - 12	300	150°C	0.013"	TFE	Office appliances
1180	28 - 10	300	200°C	0.013"	TFE	Office appliances
1198	26 - 8	600	150°C	0.020"	TFE	Office appliances
1199	26 - 8	600	200°C	0.020"	TFE	Office appliances
1212	32 - 20	Not rated	80°C	0.008"	TFE	Office appliances
1213	32 - 20	Not rated	105°C	0.008"	TFE	Office appliances
1226	30 - 20	Not rated	80°C	0.010"	FEP	Back panel wiring

California

1959 East Cashdan Street, Rancho Dominguez, CA 90220
 (310) 609-1811 • (800) 326-0006 • FAX: (310) 609-1862
 E-Mail: salesrd@std-wire.com

Arizona

3120 West Thomas Road, Bldg. #801, Phoenix, AZ 85017
 (602) 269-2501 • (800) 325-6478 • FAX: (602) 278-7134
 E-Mail: salesphx@std-wire.com



Standard Wire & Cable Co.

UL STYLE NUMBER	AWG SIZE RANGE	VOLTAGE RATING	TEMP. RATING	INSULATION		REMARKS
				THICKNESS	MATERIAL	
1227	30 - 20	Not rated	105°C	0.010"	FEP	Back panel wiring
1293	30 - 20	Not rated	105°C	0.010"	FEP / nylon	Office equipment
1294	26 - 20	Not rated	80°C	0.010"	FEP / nylon	Office equipment
1327	30 - 16	Not rated	105°C	0.010"	Kynar®	Office appliances
1330	28 - 10	600	150°C	0.020"	FEP	Office equipment
1331	28 - 10	600	200°C	0.020"	FEP	Office equipment
1332	28 - 10	300	200°C	0.013"	FEP	Office equipment
1333	28 - 10	300	150°C	0.013"	FEP	Office equipment
1351	30 - 16	Not rated	80°C	0.010"	Kynar®	Office appliances
1354	-	30	60°C	-	-	Coaxial cable
1422	32 - 20	Not rated	105°C	0.005"	Kynar®	Back panel wiring
1423	32 - 20	Not rated	105°C	0.004"	Kynar®	Back panel wiring
1426	32 - 20	Not rated	105°C	0.006"	Kynar®	Back panel wiring
1429	30 - 16	150	80°C	0.010"	Irradiated PVC	Internal wiring of appliances
1430	30 - 16	300	105°C	0.015"	Irradiated PVC	Internal wiring of appliances
1431	30 - 10	600	105°C	0.030"	Irradiated PVC	Motor lead
1431	8	600	105°C	0.045"	Irradiated PVC	Motor lead
1431	6 - 2	600	105°C	0.060"	Irradiated PVC	Motor lead
1431	1 - 1/0	600	105°C	0.078"	Irradiated PVC	Motor lead
1508	30 - 20	30	105°C	0.0055"	Tefzel®	Back panels for computers
1513	30 - 20	Not rated	105°C	0.0045"	Tefzel®	Back panels for computers
1516	30 - 20	Not rated	105°C	0.004"	Tefzel®	Back panels for computers
1517	30 - 20	Not rated	105°C	0.006"	Tefzel®	Back panels for computers

Kynar® is a registered trademark of Pennwalt Corporation.

Tefzel® is a trademark of the DuPont de Nemours Co.

California

1959 East Cashdan Street, Rancho Dominguez, CA 90220
(310) 609-1811 • (800) 326-0006 • FAX: (310) 609-1862
E-Mail: salesrd@std-wire.com

Arizona

3120 West Thomas Road, Bldg. #801, Phoenix, AZ 85017
(602) 269-2501 • (800) 325-6478 • FAX: (602) 278-7134
E-Mail: salesphx@std-wire.com



Standard Wire & Cable Co.

UL STYLE NUMBER	AWG SIZE RANGE	VOLTAGE RATING	TEMP. RATING	INSULATION		REMARKS
				THICKNESS	MATERIAL	
1523	30 - 20	Not rated	105°C	0.005"	Tefzel®	Back panels for computers
1534	30 - 14	Not rated	80°C	0.010"	Irradiated PVC	Internal wiring of appliances
1536	30 - 10	Not rated	80°C	0.010"	Irradiated PVC	Internal wiring of appliances
2095	30 - 16	300	80°C	1/64	PVC	2 conductor shielded PVC jacket
2096	30 - 16	300	80°C	1/64	PVC	3 conductor shielded PVC jacket
2097	30 - 16	300	80°C	1/64	PVC	4 conductor shielded PVC jacket
2098	26 - 16	300	90°C	1/64	PVC	2 conductor shielded PVC jacket
2099	26 - 16	300	90°C	1/64	PVC	3 conductor shielded PVC jacket
2100	26 - 16	300	90°C	1/64	PVC	4 conductor shielded PVC jacket
2101	26 - 16	300	105°C	1/64	PVC	2 conductor shielded PVC jacket
2102	26 - 16	300	105°C	1/64	PVC	3 conductor shielded PVC jacket
2103	26 - 16	300	105°C	1/64	PVC	4 conductor shielded PVC jacket
2106	26 - 16	600	60°C	1/32	PE	2 conductor shielded PVC jacket
2107	26 - 16	600	60°C	1/32	PE	3 conductor shielded PVC jacket
2108	26 - 16	600	60°C	1/32	PE	4 conductor shielded PVC jacket
2115	26 - 16	600	80°C	1/32	PVC	2 conductor shielded PVC jacket
2116	26 - 16	600	80°C	1/32	PVC	3 conductor shielded PVC jacket
2117	26 - 16	600	80°C	1/32	PVC	4 conductor shielded PVC jacket
2343	30 min.	Not rated	80°C	-	-	Computer cable 0.060" PVC jacket
2344	30 min.	Not rated	80°C	-	-	Computer cable 0.080" PVC jacket
2345	30 min.	Not rated	80°C	-	-	Computer cable 0.110" PVC jacket

Tefzel® is a trademark of the DuPont de Nemours Co.

California

1959 East Cashdan Street, Rancho Dominguez, CA 90220
(310) 609-1811 • (800) 326-0006 • FAX: (310) 609-1862
E-Mail: salesrd@std-wire.com

Arizona

3120 West Thomas Road, Bldg. #801, Phoenix, AZ 85017
(602) 269-2501 • (800) 325-6478 • FAX: (602) 278-7134
E-Mail: salesphx@std-wire.com



Standard Wire & Cable Co.

UL STYLE NUMBER	AWG SIZE RANGE	VOLTAGE RATING	TEMP. RATING	INSULATION		REMARKS
				THICKNESS	MATERIAL	
2346	30 min.	Not rated	80°C	-	-	Computer cable 0.140" PVC jacket
2384	30 min.	300	60°C	-	-	Computer cable 0.035" PVC jacket
2385	30 min.	300	60°C	-	-	Computer cable 0.060" PVC jacket
2386	30 min.	300	60°C	-	-	Computer cable 0.080" PVC jacket
2387	30 min.	300	60°C	-	-	Computer cable 0.110" PVC jacket
2388	30 min.	300	60°C	-	-	Computer cable 0.140" PVC jacket
2448	30 min.	30	60°C	-	-	Low voltage computer cable
2461	26 - 16	300	80°C	-	-	2 - 61 conductor PVC jacket
2462	24 - 16	300	60°C	-	-	2 - 61 conductor PVC jacket
2463	26 - 16	600	80°C	-	-	2 - 19 conductor PVC jacket
2464	30 - 16	300	80°C	-	-	Multi-conductor control cable PVC
2490	30 - 16	Not rated	60°C	-	-	Multi-conductor control cable PVC
2493	30 - 16	Not rated	60°C	-	-	Multi-conductor control cable PVC
2501	30 min.	600	105°C	-	-	Multi-conductor control cable PVC
2502	40 min.	30	80°C	-	-	Multi-conductor control cable PVC
2507	32 - 26	Not rated	105°C	-	-	Multi-conductor control cable PVC
3068	26 - 20	300	105°C	0.016"	Silicone rubber / glass braid	Internal wiring of appliances
3069	26 - 20	600	150°C	0.032"	Silicone rubber / glass braid	Internal wiring of appliances
3070	18 - 12	600	150°C	0.032"	Silicone rubber / glass braid	Internal wiring of appliances
3071	18 - 14	600	200°C	0.032"	Silicone rubber / glass braid	Internal wiring of appliances
3074	12	600	200°C	0.032"	Silicone rubber / glass braid	Internal wiring of appliances

California

1959 East Cashdan Street, Rancho Dominguez, CA 90220
 (310) 609-1811 • (800) 326-0006 • FAX: (310) 609-1862
 E-Mail: salesrd@std-wire.com

Arizona

3120 West Thomas Road, Bldg. #801, Phoenix, AZ 85017
 (602) 269-2501 • (800) 325-6478 • FAX: (602) 278-7134
 E-Mail: salesphx@std-wire.com



Standard Wire & Cable Co.

UL STYLE NUMBER	AWG SIZE RANGE	VOLTAGE RATING	TEMP. RATING	INSULATION		REMARKS
				THICKNESS	MATERIAL	
3075	10	600	200°C	0.032"	Silicone rubber / glass braid	Internal wiring of appliances
3101	10	600	150°C	0.048"	Silicone rubber / glass braid	Internal wiring of appliances
3122	26 - 20	300	200°C	0.016"	Silicone rubber / glass braid	Internal wiring of appliances
3123	30 - 16	600	150°C	0.030"	Silicone rubber	Internal wiring of appliances
3132	30 - 16	300	150°C	0.015"	Silicone rubber	Internal wiring of appliances
3133	30 - 16	600	150°C	0.030"	Silicone rubber	Internal wiring of appliances
3134	18 - 12	600	150°C	0.032"	Silicone rubber	Internal wiring of appliances
3135	18 - 12	600	200°C	0.032"	Silicone rubber	Internal wiring of appliances
3136	26 - 20	300	150°C	0.048"	Silicone rubber	Internal wiring of appliances
3137	26 - 20	600	150°C	0.048"	Silicone rubber	Internal wiring of appliances
3138	18 - 12	600	150°C	0.048"	Silicone rubber	Internal wiring of appliances
3139	18 - 12	600	200°C	0.048"	Silicone rubber	Internal wiring of appliances
3142	18 - 12	600	150°C	0.064"	Silicone rubber	Internal wiring of appliances
3143	18 - 12	600	200°C	0.064"	Silicone rubber	Internal wiring of appliances
3167	26 - 9	600	105°C	0.032"	XLPE	Internal wiring of appliances
3168	18 - 12	1000	90°C	0.032"	XLPE	Internal wiring of appliances
3173	26 - 9	600	125°C	0.032"	XLPE	Internal wiring of appliances
3182	26 - 9	600	125°C	0.048"	XLPE	Internal wiring of appliances
3195	8	600	125°C	0.048"	XLPE	Internal wiring of appliances
3196	7 - 4	600	125°C	0.064"	XLPE	Internal wiring of appliances

California

1959 East Cashdan Street, Rancho Dominguez, CA 90220
 (310) 609-1811 • (800) 326-0006 • FAX: (310) 609-1862
 E-Mail: salesrd@std-wire.com

Arizona

3120 West Thomas Road, Bldg. #801, Phoenix, AZ 85017
 (602) 269-2501 • (800) 325-6478 • FAX: (602) 278-7134
 E-Mail: salesphx@std-wire.com



COMPARISON

Specifications	Operating Temperature	Oper. Voltage	AWG Size Range	Cond. Material	Primary Insulation	Secondary Insulation	Jacket	Dielectric Strength Min. KV	Comments
M5086 /1 /2 /3	-55° C +105° C	600	22 - 10 22 - 4/0	TC	PVC	None glass glass PVC	Nylon	1.5	
MIL-W-7139B I II	-65° C +200° C -65° C +260° C	600	22 - 4/0	SPC NPC	TFE film glass tape		Teflon® glass braid	1.5	Replaced by M22759/1&2
MIL-W-8777C MS 25471	-55° C +200° C	600	22 - 2/0	SPC	silicone rubber	lacquered synthetic fiber	when specified FEP or none	1.5	
MIL-W-25038 M25038/1 M25038/3	+260° C (+2000° F)**	600	22 - 4/0 22 - 12	NCC	inorganic dielectric & TFE		Teflon® glass braid	1.5	
MIL-W-16878D Type B MIL-W-16878/1	-54° C +105° C	600	32 - 14	TC	PVC		as specified	2.0	
Type C MIL-W-16878/2	-54° C +105° C	1,000	26 - 12	TC	PVC		as specified	3.0	
Type D MIL-W-16878/3	-54° C +105° C	3,000	24 - 1/0	TC	PVC		as specified	6.0	
Type E MIL-W-16878/4	-65° C +200° C -65° C +260° C	600	32 - 10	SPC NPC	TFE		as specified*	2.2	
Type EE MIL-W-16878/5	-65° C +200° C -65° C +260° C	1,000	32 - 8	SPC NPC	TFE		as specified*	3.0	
Type ET MIL-W-16878/6	-65° C +200° C -65° C +260° C	250	32 - 20	SPC NPC	TFE		as specified*	1.5	
Type F MIL-W-16878/7	-54° C +200° C	600	24 - 12	TC SPC NPC	silicone rubber		as specified* glass braid recommended	2.2	
Type FF MIL-W-16878/8	-54° C +200° C	1,000	24 - 4/0	TC SPC NPC	silicone rubber		as specified* glass braid recommended	3.0	
Type J MIL-W-16878/10	-65° C +75° C	600	24 - 4/0	TC BC	polyethylene		as specified*	2.2	
Type K MIL-W-16878/11	-65° C +200° C	600	32 - 8	TC SPC	FEP		as specified*	2.0	
Type KK MIL-W-16878/12	-65° C +200° C	1,000	32 - 4/0	TC SPC	FEP		as specified*	3.0	
Type KT MIL-W-16878/13	-65° C +200° C	250	32 - 20	TC SPC	FEP		as specified*	1.5	
MS 17331	-65° C +200° C	600	22 - 8	SPC	TFE	TFE impregnate asbestos	None	2.5	Canceled

Teflon® is a trademark of the DuPont de Nemours Co.

* Increase of outside diameters dependent on jacketing material used.

** For short-term intervals.

California

1959 East Cashdan Street, Rancho Dominguez, CA 90220
(310) 609-1811 • (800) 326-0006 • FAX: (310) 609-1862
E-Mail: salesrd@std-wire.com

Arizona

3120 West Thomas Road, Bldg. #801, Phoenix, AZ 85017
(602) 269-2501 • (800) 325-6478 • FAX: (602) 278-7134
E-Mail: salesphx@std-wire.com



CHART

AWG MAXIMUM OUTSIDE DIAMETERS (see footnote *)																				
32	30	28	26	24	22	20	18	16	14	12	10	8	6	4	2	1	1/0	2/0	3/0	4/0
					0.072	0.082	0.092	0.102	0.122	0.142	0.164									
					0.080	0.090	0.100	0.110	0.132	0.150	0.196	0.247	0.300	0.365	0.435	0.480	0.540	0.605	0.665	0.735
					0.090	0.100	0.115	0.130	0.150	0.170	0.200	0.255	0.310	0.370	0.445	0.495	0.550	0.610	0.680	0.750
					0.090	0.100	0.115	0.135	0.150	0.170	0.200	0.255	0.310	0.370	0.445	0.495	0.550	0.610	0.680	0.750
			without jacket		0.090	0.100	0.115	0.130	0.150	0.170	0.200	0.255	0.310	0.370	0.435	0.470	0.550	0.590		
			with jacket		0.106	0.115	0.128	0.136	0.163	0.183	0.217	0.272	0.311	0.386						
					0.116	0.125	0.135	0.147	0.170	0.185	0.230	0.280	0.342	0.407	0.484	0.533	0.573	0.635	0.700	0.770
					0.054	0.083	0.097	0.103	0.123	0.142										
0.031	0.034	0.037	0.041	0.047	0.053	0.061	0.071	0.081	0.095	For nylon jackets on types B, C, & D O.D. of 0.080" or less, add 0.004" to 0.008" O.D. of 0.081" or more, add 10%										
			0.057	0.062	0.068	0.076	0.086	0.095	0.109											
				0.090	0.096	0.104	0.114	0.123	0.137	0.169	0.189	0.254	0.298	0.366	0.435	0.488	.538			
0.033	0.036	0.039	0.043	0.048	0.054	0.062	0.074	0.087	0.101	0.120	0.141									
0.043	0.046	0.049	0.053	0.058	0.064	0.072	0.084	0.095	0.113	0.132	0.153	0.197								
0.023	0.026	0.029	0.033	0.038	0.044	0.052														
				0.058	0.064	0.072	0.082	0.091	0.121	0.140										
				0.091	0.097	0.105	0.115	0.124	0.171	0.190	0.210	0.307	0.351	0.407	0.473	0.550	0.596	0.649	0.725	0.773
				0.053	0.060	0.070	0.080	0.091	0.110	0.129	0.156	0.226	0.282	0.349	0.415	0.465	0.511	0.585	0.633	0.710
0.034	0.036	0.039	0.043	0.048	0.054	0.062	0.074	0.087	0.102	0.121	0.141	0.199								
0.043	0.046	0.049	0.053	0.058	0.064	0.072	0.084	0.095	0.114	0.133	0.153	0.219	0.301	0.369	0.415	0.495	0.524	0.577	0.657	0.727
0.024	0.026	0.029	0.033	0.038	0.044	0.052														
					0.080	0.090	0.103	0.115	0.140	0.160	0.193	0.245								

California

1959 East Cashdan Street, Rancho Dominguez, CA 90220
 (310) 609-1811 • (800) 326-0006 • FAX: (310) 609-1862
 E-Mail: salesrd@std-wire.com

Arizona

3120 West Thomas Road, Bldg. #801, Phoenix, AZ 85017
 (602) 269-2501 • (800) 325-6478 • FAX: (602) 278-7134
 E-Mail: salesphx@std-wire.com



Standard Wire & Cable Co.

Specifications	Operating Temperature	Oper. Voltage	AWG Size Range	Cond. Material	Primary Insulation	Secondary Insulation	Jacket	Dielectric Strength Min. KV	Comments
MS 17332	-65°C +260°C	600	22 - 8	NPC	TFE	TFE impregnated asbestos	None	2.5	Canceled
MS 17410	-65°C +200°C	600	22 - 2/0	SPC	TFE	TFE coated glass braid	FEP	2.2	Canceled
MS 17411	-65°C +200°C	600	24 - 4	SPC	TFE mineral filled		None	2.5	Canceled
MS 17412	-65°C +260°C	600	24 - 4	NPC	TFE mineral filled		None	2.5	Canceled
MS 18000	-65°C +200°C	600	24 - 4	SPC	TFE mineral filled		None	2.5	
MS 18001	-65°C +260°C	600	24 - 4	NPC	TFE mineral filled		None	2.5	
MS 18032	-65°C +200°C	600	30 - 2	SPC	Laminated TFE		None	2.5	Canceled
MS 18033	-65°C +260°C	600	30 - 2	NPC	Laminated TFE		None	2.5	Canceled
MS 18104	-65°C +200°C	600	28 - 12	SPC	TFE		polyimide	3.0	Canceled
MS 18105	-65°C +260°C	600	28 - 12	NPC	TFE		polyimide	3.0	Canceled
MS 18113	-65°C +200°C	1000	28 - 8	SPC	TFE		None	3.0	Canceled
MS 18114	-65°C +260°C	1000	28 - 8	NPC	TFE		None	3.0	Canceled
MS 21985	-65°C +200°C	600	28 - 16	SPC	TFE		None	2.2	
MS 21986	-65°C +260°C	600	28 - 16	NPC	TFE		None	2.2	
MS 27110	-55 ° C +200° C	600	22 - 4	SPC	silicone rubber	lacquered synthetic fiber	FEP	1.5	
MS 90294	-65°C +200°C	600	22 - 2/0	SPC	TFE tape & / or TFE coated glass tape	TFE coated glass braid	FEP	2.5	
MIL-W-22759/1	-65°C +200°C	600	22 - 4/0	SPC	TFE or TFE tape	TFE coated glass tape	TFE coated glass braid	2.5	Supersedes MIL-W-7139B Class I
MIL-W-22759/2	-65°C +260°C	600	22 - 4/0	NPC	TFE or TFE tape	TFE coated glass tape	TFE coated glass braid	2.5	Supersedes MIL-W-7139B Class II
MIL-W-22759/3	-65°C +260°C	600	22 - 2/0	NPC	TFE tape & / or TFE coated glass tape	TFE coated glass braid	TFE tape	2.5	

* Increase of outside diameters dependent on jacketing material used.

California

1959 East Cashdan Street, Rancho Dominguez, CA 90220
 (310) 609-1811 • (800) 326-0006 • FAX: (310) 609-1862
 E-Mail: salesrd@std-wire.com

Arizona

3120 West Thomas Road, Bldg. #801, Phoenix, AZ 85017
 (602) 269-2501 • (800) 325-6478 • FAX: (602) 278-7134
 E-Mail: salesphx@std-wire.com



Standard Wire & Cable Co.

AWG MAXIMUM OUTSIDE DIAMETERS (see footnote *)																				
32	30	28	26	24	22	20	18	16	14	12	10	8	6	4	2	1	1/0	2/0	3/0	4/0
					0.080	0.090	0.103	0.115	0.140	0.160	0.193	0.245								
					0.090	0.100	0.115	0.130	0.150	0.0170	0.200	0.255	0.310	0.370	0.445	0.495	0.550	0.610		
				0.080	0.090	0.100	0.115	0.130	0.150	0.0170	0.200	0.255	0.310	0.370						
				0.080	0.090	0.100	0.115	0.130	0.150	0.0170	0.200	0.255	0.310	0.370						
				0.064	0.075	0.084	0.094	0.105	0.118	0.137	0.172	0.225	0.276	0.335						
				0.064	0.075	0.084	0.094	0.105	0.118	0.137	0.172	0.225	0.276	0.335						
	0.027	0.030	0.035	0.040	0.047	0.055	0.070	0.076	0.091	0.114	0.150	0.196	0.244	0.307	0.388					
	0.027	0.030	0.035	0.040	0.047	0.055	0.070	0.076	0.091	0.114	0.150	0.196	0.244	0.307	0.388					
		0.037	0.041	0.045	0.052	0.060	0.072	0.082	0.103	0.124										
		0.037	0.041	0.045	0.052	0.060	0.072	0.082	0.103	0.124										
		0.045	0.050	0.055	0.062	0.070	0.080	0.087	0.103	0.124	0.145	0.212								
		0.045	0.050	0.055	0.062	0.070	0.080	0.087	0.103	0.124	0.145	0.212								
		0.033	0.040	0.045	0.051	0.060	0.070	0.077												
		0.033	0.040	0.045	0.051	0.060	0.070	0.077												
					0.106	0.115	0.128	0.136	0.163	0.183	0.217	0.272	0.311	0.386						
					0.077	0.085	0.098	0.109	0.120	0.136	0.173	0.245	0.292	0.364	0.445	0.495	0.550	0.610		
					0.088	0.098	0.110	0.125	0.143	0.162	0.188	0.255	0.303	0.370	0.435	0.485	0.535	0.595	0.660	0.730
					0.088	0.098	0.110	0.125	0.143	0.162	0.188	0.255	0.303	0.370	0.435	0.485	0.535	0.595	0.660	0.730
					0.077	0.085	0.098	0.107	0.120	0.137	0.170	0.242	0.292	0.366	0.445	0.495	0.550	0.610		

California

1959 East Cashdan Street, Rancho Dominguez, CA 90220
 (310) 609-1811 • (800) 326-0006 • FAX: (310) 609-1862
 E-Mail: salesrd@std-wire.com

Arizona

3120 West Thomas Road, Bldg. #801, Phoenix, AZ 85017
 (602) 269-2501 • (800) 325-6478 • FAX: (602) 278-7134
 E-Mail: salesphx@std-wire.com



Standard Wire & Cable Co.

Specifications	Operating Temperature	Oper. Voltage	AWG Size Range	Cond. Material	Primary Insulation	Secondary Insulation	Jacket	Dielectric Strength Min. KV	Comments
MIL-W-22759/4	-65°C +200°C	600	22 - 2/0	SPC	TFE tape & / or TFE coated glass tape	TFE coated glass braid	FEP	2.5	Supersedes MS 90294
MIL-W-22759/5	-65°C +200°C	600	24 - 4	SPC	TFE mineral filled		None	2.5	Supersedes MS 17411
MIL-W-22759/6	-65°C +260°C	600	24 - 4	NPC	TFE mineral filled		None	2.5	Supersedes MS 17412
MIL-W-22759/7	-65°C +200°C	600	24 - 4	SPC	TFE mineral filled		None	2.5	Supersedes MS 18000
MIL-W-22759/8	-65°C +260°C	600	24 - 4	NPC	TFE mineral filled		None	2.5	Supersedes MS 18001
MIL-W-22759/9	-65°C +200°C	1000	28 - 8	SPC	TFE		None	3.0	Supersedes MS 18113
MIL-W-22759/10	-65°C +260°C	1000	28 - 8	NPC	TFE		None	3.0	Supersedes MS 18114
MIL-W-22759/11	-65°C +200°C	600	28 - 8	SPC	TFE		None	2.2	Supersedes MS 21985
MIL-W-22759/12	-65°C +260°C	600	28 - 8	NPC	TFE		None	2.2	Supersedes MS 21986
MIL-W-22759/13	-55°C +135°C	600	24 - 1/0	TC	FEP		polyvinylidene fluoride	2.0	
MIL-W-22759/14	-55°C +135°C	600	26 - 12	TC	FEP		polyvinylidene fluoride	2.0	
MIL-W-22759/15	-55°C +135°C	600	26 - 20	SPC alloy	FEP		polyvinylidene fluoride	2.0	
MIL-W-22759/16	-65°C +150°C	600	24 - 2/0	TC	ETFE		None	2.2	
MIL-W-22759/17	-65°C +150°C	600	26 - 20	SPC alloy	ETFE		None	2.2	
MIL-W-22759/18	-65°C +150°C	600	26 - 10	TC	ETFE		None	2.0	
MIL-W-22759/19	-65°C +150°C	600	26 - 20	SPC alloy	ETFE		None	2.0	
MIL-W-22759/20	-65°C +200°C	1000	28 - 20	SPC alloy	TFE		None	3.0	
MIL-W-22759/21	-65°C +200°C	1000	28 - 20	NPC alloy	TFE		None	3.0	
MIL-W-22759/22	-65°C +200°C	600	28 - 20	SPC alloy	TFE		None	2.2	
MIL-W-22759/23	-65°C +260°C	600	28 - 20	NPC alloy	TFE		None	2.2	
MIL-W-22759/24	-65°C +150°C	600	24 - 2/0	TC	ECTFE		None	2.2	

* Increase of outside diameters dependent on jacketing material used.

California

1959 East Cashdan Street, Rancho Dominguez, CA 90220
(310) 609-1811 • (800) 326-0006 • FAX: (310) 609-1862
E-Mail: salesrd@std-wire.com

Arizona

3120 West Thomas Road, Bldg. #801, Phoenix, AZ 85017
(602) 269-2501 • (800) 325-6478 • FAX: (602) 278-7134
E-Mail: salesphx@std-wire.com



Standard Wire & Cable Co.

AWG MAXIMUM OUTSIDE DIAMETERS (see footnote *)																				
32	30	28	26	24	22	20	18	16	14	12	10	8	6	4	2	1	1/0	2/0	3/0	4/0
					0.077	0.085	0.098	0.107	0.120	0.137	0.170	0.242	0.292	0.366	0.445	0.495	0.550	0.610		
				0.080	0.090	0.100	0.115	0.130	0.150	0.167	0.186	0.225	0.310	0.370						
				0.080	0.090	0.100	0.115	0.130	0.150	0.167	0.186	0.255	0.310	0.370						
				0.064	0.075	0.084	0.094	0.105	0.118	0.137	0.162	0.225	0.276	0.335						
				0.064	0.075	0.084	0.094	0.105	0.118	0.137	0.162	0.225	0.276	0.335						
		0.045	0.050	0.055	0.062	0.070	0.080	0.087	0.103	0.124	0.145	0.212								
		0.045	0.050	0.055	0.062	0.070	0.080	0.087	0.103	0.124	0.145	0.212								
		0.035	0.040	0.045	0.051	0.060	0.070	0.077	0.092	0.114	0.143	0.206								
		0.035	0.040	0.045	0.051	0.060	0.070	0.077	0.092	0.114	0.143	0.208								
				0.051	0.054	0.064	0.074	0.081	0.095	0.115	0.142	0.202	0.253	0.308	0.386	0.426	0.474			
			0.039	0.044	0.051	0.059	0.069	0.075	0.091	0.111										
			0.039	0.044	0.051	0.059														
				0.047	0.054	0.062	0.073	0.081	0.095	0.117	0.142	0.202	0.253	0.316	0.392	0.436	0.485	0.553		
				0.042	0.047	0.054	0.062													
				0.034	0.038	0.045	0.053	0.063	0.072	0.087	0.110	0.137								
				0.034	0.038	0.045	0.053													
		0.045	0.050	0.055	0.062	0.070														
		0.045	0.050	0.055	0.062	0.070														
		0.035	0.040	0.045	0.051	0.060														
		0.035	0.040	0.045	0.051	0.060														
				0.047	0.054	0.062	0.073	0.081	0.095	0.117	0.142	0.202	0.253	0.316	0.392	0.436	0.485	0.553		

California

1959 East Cashdan Street, Rancho Dominguez, CA 90220
 (310) 609-1811 • (800) 326-0006 • FAX: (310) 609-1862
 E-Mail: salesrd@std-wire.com

Arizona

3120 West Thomas Road, Bldg. #801, Phoenix, AZ 85017
 (602) 269-2501 • (800) 325-6478 • FAX: (602) 278-7134
 E-Mail: salesphx@std-wire.com



Standard Wire & Cable Co.

Specifications	Operating Temperature	Oper. Voltage	AWG Size Range	Cond. Material	Primary Insulation	Secondary Insulation	Jacket	Dielectric Strength Min. KV
MIL-W-22759/25	-65°C +150°C	600	26 - 20	SPC alloy	ECTFE		None	2.2
MIL-W-22759/26	-65°C +150°C	600	26 - 10	TC	ECTFE		None	2.0
MIL-W-22759/27	-65°C +150°C	600	26 - 20	SPC alloy	ECTFE		None	2.0
MIL-W-22759/28	-65°C +200°C	600	28 - 8	SPC	TFE	polyimide	None	2.2
MIL-W-22759/29	-65°C +260°C	600	28 - 8	NPC	TFE	polyimide	None	2.2
MIL-W-22759/30	-65°C +200°C	600	28 - 20	SPC alloy	TFE	polyimide	None	2.2
MIL-W-22759/31	-65°C +260°C	600	28 - 20	NPC alloy	TFE	polyimide	None	2.2
MIL-W-22759/32	-65°C +150°C	600	30 - 12	TC	XETFE		None	2.5
MIL-W-22759/33	-65°C +150°C	600	30 - 20	SPC alloy	XETFE		None	2.5
MIL-W-22759/34	-65°C +150°C	600	24 - 2/0	TC	XETFE	XETFE	None	2.5
MIL-W-22759/35	-65°C +150°C	600	26 - 20	SPC alloy	XETFE	XETFE	None	2.5
MIL-W-22759/36	-65°C +135°C	600	26 - 12	TC	XLPA		ECTFE	2.5
MIL-W-22759/37	-65°C +150°C	600	24 - 12	TC	XLPA		ECTFE	2.5
MIL-W-22759/38	-65°C +135°C	600	26 - 20	SPC alloy	XLPA		ECTFE	2.5
MIL-W-22759/39	-65°C +135°C	600	26 - 10	TC	XLPA		ECTFE	2.5
MIL-W-22759/40	-65°C +135°C	600	26 - 20	SPC alloy	XLPA		ECTFE	2.5
MIL-W-22759/41	-65°C +200°C	600	26 - 2/0	NPC	XETFE	XETFE	None	2.5
MIL-W-22759/42	-65°C +200°C	600	26 - 20	NPC alloy	XETFE	XETFE	None	2.5
MIL-W-22759/43	-65°C +200°C	600	26 - 2/0	SPC	XETFE	XETFE	None	2.5
MIL-W-22759/44	-65°C +200°C	600	28 - 12	SPC	XETFE	XETFE	None	2.5
MIL-W-22759/45	-65°C +200°C	600	28 - 12	NPC	XETFE	XETFE	None	2.5
MIL-W-22759/46	-65°C +200°C	600	28 - 20	NPC alloy	XETFE	XETFE	None	2.5
MIL-W-22759/80	-65°C +150°C	600	26 - 10	TC	PTFE/polyimide	PTFE	None	3.0
MIL-W-22759/81	-65°C +200°C	600	26 - 20	SPC	PTFE/polyimide	PTFE	None	3.0

California

1959 East Cashdan Street, Rancho Dominguez, CA 90220
 (310) 609-1811 • (800) 326-0006 • FAX: (310) 609-1862
 E-Mail: salesrd@std-wire.com

Arizona

3120 West Thomas Road, Bldg. #801, Phoenix, AZ 85017
 (602) 269-2501 • (800) 325-6478 • FAX: (602) 278-7134
 E-Mail: salesphx@std-wire.com



Standard Wire & Cable Co.

AWG MAXIMUM OUTSIDE DIAMETERS (see footnote *)																				
32	30	28	26	24	22	20	18	16	14	12	10	8	6	4	2	1	1/0	2/0	3/0	4/0
			0.042	0.047	0.054	0.062														
			0.034	0.038	0.045	0.053	0.063	0.069	0.083	0.105	0.128									
			0.034	0.038	0.045	0.053														
		0.036	0.041	0.046	0.052	0.061	0.071	0.079	0.094	0.114	0.143	0.200								
		0.036	0.041	0.046	0.052	0.061	0.071	0.079	0.094	0.114	0.143	0.204								
		0.036	0.041	0.046	0.052	0.061														
		0.036	0.041	0.046	0.052	0.061														
	0.026	0.029	0.034	0.039	0.045	0.052	0.062	0.070	0.088	0.106										
	0.026	0.029	0.034	0.039	0.045	0.052														
			0.047	0.052	0.060	0.073	0.080	0.097	0.114	0.138	0.203	0.251	0.320	0.421	0.461	0.501	0.561			
			0.042	0.047	0.052	0.060														
			0.036	0.042	0.049	0.057	0.067	0.075	0.093	0.112										
			0.056	0.065	0.073	0.083	0.093	0.112	0.130											
			0.036	0.042	0.049	0.057														
			0.042	0.046	0.053	0.062	0.074	0.082	0.096	0.119	0.143									
			0.042	0.046	0.053	0.062														
			0.042	0.047	0.052	0.060	0.073	0.080	0.097	0.114	0.138	0.203	0.251	0.320	0.421	0.461	0.501	0.561		
			0.042	0.047	0.052	0.060														
			0.042	0.047	0.052	0.060	0.073	0.080	0.097	0.114	0.138	0.203	0.251	0.320	0.421	0.461	0.501	0.561		
		0.029	0.034	0.039	0.045	0.052	0.062	0.070	0.088	0.106										
		0.029	0.034	0.039	0.045	0.052	0.062	0.070	0.088	0.106										
		0.029	0.034	0.039	0.045	0.052														
			0.034	0.038	0.043	0.051	0.060	0.069	0.082	0.101	0.124									
			0.034	0.038	0.043	0.051														

* Increase of outside diameters dependent on jacketing material used.

California

1959 East Cashdan Street, Rancho Dominguez, CA 90220
 (310) 609-1811 • (800) 326-0006 • FAX: (310) 609-1862
 E-Mail: salesrd@std-wire.com

Arizona

3120 West Thomas Road, Bldg. #801, Phoenix, AZ 85017
 (602) 269-2501 • (800) 325-6478 • FAX: (602) 278-7134
 E-Mail: salesphx@std-wire.com



Standard Wire & Cable Co.

Specifications	Operating Temperature	Oper. Voltage	AWG Size Range	Cond. Material	Primary Insulation	Secondary Insulation	Jacket	Dielectric Strength Min. KV
MIL-W-22759/82	-65°C +200°C	600	26 - 20	NPC	PTFE/polyimide	PTFE	None	3.0
MIL-W-22759/83	-65°C +200°C	600	2 - 4/0	SPC	PTFE/polyimide	PTFE	None	3.0
MIL-W-22759/84	-65°C +200°C	600	2 - 4/0	NPC	PTFE/polyimide	PTFE	None	3.0
MIL-W-22759/85	-65°C +150°C	600	2 - 4/0	TC	PTFE/polyimide	PTFE	None	3.0
MIL-W-22759/86	-65°C +200°C	600	26 - 4/0	SPC	PTFE/polyimide	PTFE	None	3.0
MIL-W-22759/87	-65°C +200°C	600	26 - 4/0	NPC	PTFE/polyimide	PTFE	None	3.0
MIL-W-22759/88	-65°C +150°C	600	26 - 4/0	TC	PTFE/polyimide	PTFE	None	3.0
MIL-W-22759/89	-65°C +200°C	600	26 - 20	SPC	PTFE/polyimide	PTFE	None	3.0
MIL-W-22759/90	-65°C +200°C	600	26 - 20	NPC	PTFE/polyimide	PTFE	None	3.0
MIL-W-22759/91	-65°C +200°C	600	26 - 10	SPC	PTFE/polyimide	PTFE	None	3.0
MIL-W-22759/92	-65°C +200°C	600	26 - 10	NPC	PTFE/polyimide	PTFE	None	3.0
MIL-W-81044/1	-65°C +135°C	600	24 - 4	SPC	XLPA		XLPVF	2.5
MIL-W-81044/2	-65°C +135°C	600	24 - 4	TC	XLPA		XLPVF	2.5
MIL-W-81044/3	-65°C +135°C	600	30 - 12	SPC	XLPA		XLPVF	2.5
MIL-W-81044/4	-65°C +135°C	600	30 - 12	TC	XLPA		XLPVF	2.5
MIL-W-81044/5	-65°C +150°C	600	24 - 1/0	SPC	XLPA		XLPVF	2.5
MIL-W-81044/6	-65°C +150°C	600	24 - 1/0	TC	XLPA		XLPVF	2.5
MIL-W-81044/7	-65°C +150°C	600	26 - 20	SPC alloy	XLPA		XLPVF	2.5
MIL-W-81044/8	-65°C +150°C	600	24 - 1/0	SPC	XLPA		XLPVF	2.5
MIL-W-81044/9	-65°C +150°C	600	24 - 1/0	TC	XLPA		XLPVF	2.5
MIL-W81044/10	-65°C +150°C	600	26 - 20	SPC alloy	XLPA		XLPVF	2.5
MIL-W-81044/11	-65°C +150°C	600	30 - 12	SPC	XLPA		XLPVF	2.5
MIL-W-81044/12	-65°C +150°C	600	30 - 12	TC	XLPA		XLPVF	2.5
MIL-W-81044/13	-65°C +150°C	600	30 - 20	SPC alloy	XLPA		XLPVF	2.5

California

1959 East Cashdan Street, Rancho Dominguez, CA 90220
 (310) 609-1811 • (800) 326-0006 • FAX: (310) 609-1862
 E-Mail: salesrd@std-wire.com

Arizona

3120 West Thomas Road, Bldg. #801, Phoenix, AZ 85017
 (602) 269-2501 • (800) 325-6478 • FAX: (602) 278-7134
 E-Mail: salesphx@std-wire.com



Standard Wire & Cable Co.

AWG MAXIMUM OUTSIDE DIAMETERS (see footnote *)																				
32	30	28	26	24	22	20	18	16	14	12	10	8	6	4	2	1	1/0	2/0	3/0	4/0
			0.034	0.038	0.043	0.051														
															0.380	0.420	0.462	0.528	0.584	0.655
															0.380	0.420	0.462	0.528	0.584	0.655
															0.380	0.420	0.462	0.528	0.584	0.655
			0.037	0.042	0.047	0.055	0.068	0.073	0.086	0.105	0.127	0.188	0.229	0.288	0.364	0.408	0.450	0.505	0.560	0.630
			0.037	0.042	0.047	0.055	0.068	0.073	0.086	0.105	0.127	0.188	0.229	0.288	0.364	0.408	0.450	0.505	0.560	0.630
			0.037	0.042	0.047	0.055	0.068	0.073	0.086	0.105	0.127	0.188	0.229	0.288	0.364	0.408	0.450	0.505	0.560	0.630
			0.037	0.042	0.047	0.055														
			0.037	0.042	0.047	0.055														
			0.034	0.0375	0.043	0.051	0.060	0.069	0.082	0.101	0.124									
			0.034	0.0375	0.043	0.051	0.060	0.069	0.082	0.101	0.124									
				0.060	0.072	0.081	0.091	0.101	0.119	0.112	0.166	0.225	0.276	0.333						
				0.060	0.072	0.081	0.091	0.101	0.119	0.112	0.166	0.225	0.276	0.333						
	0.029	0.032	0.036	0.042	0.049	0.057	0.067	0.075	0.091	0.112										
	0.029	0.032	0.036	0.042	0.049	0.057	0.067	0.075	0.091	0.112										
				0.059	0.072	0.081	0.091	0.101	0.119	0.135	0.166	0.225	0.276	0.333	0.416	N/A	0.510			
				0.059	0.072	0.081	0.091	0.101	0.119	0.135	0.166	0.225	0.276	0.333	0.416	N/A	0.510			
			0.055	0.059	0.072	0.081														
				0.056	0.065	0.073	0.083	0.093	0.112	0.130	0.160	0.220	0.271	0.328	0.412	N/A	0.506			
				0.056	0.065	0.073	0.083	0.093	0.112	0.130	0.160	0.220	0.271	0.328	0.412	N/A	0.506			
			0.050	0.056	0.065	0.073														
	0.029	0.032	0.036	0.042	0.049	0.057	0.067	0.075	0.093	0.112										
	0.029	0.032	0.036	0.042	0.049	0.057	0.067	0.075	0.093	0.112										
	0.029	0.032	0.036	0.042	0.049	0.057														

* Increase of outside diameters dependent on jacketing material used.

California

1959 East Cashdan Street, Rancho Dominguez, CA 90220
 (310) 609-1811 • (800) 326-0006 • FAX: (310) 609-1862
 E-Mail: salesrd@std-wire.com

Arizona

3120 West Thomas Road, Bldg. #801, Phoenix, AZ 85017
 (602) 269-2501 • (800) 325-6478 • FAX: (602) 278-7134
 E-Mail: salesphx@std-wire.com



Standard Wire & Cable Co.

Specifications	Operating Temperature	Oper. Voltage	AWG Size Range	Cond. Material	Primary Insulation	Secondary Insulation	Jacket	Dielectric Strength Min. KV
MIL-W-81044/14	-65°C +135°C	600	24 - 1/0	TC	XLPA		XLPVF	2.5
MIL-W-81044/15	-65°C +135°C	600	26 - 20	SPC	XLPA		XLPVF	2.5
MIL-W-81044/16	-65°C +150°C	600	24 - 2/0	TC	XLAP	XLAP	MIP	2.5
MIL-W-81044/17	-65°C +150°C	600	26 - 20	SPC alloy	XLAP	XLAP	MIP	2.5
MIL-W-81044/18	-65°C +150°C	600	30 - 12	TC	XLAP	XLAP	MIP	2.5
MIL-W-81044/19	-65°C +150°C	600	30 - 20	SPC alloy	XLPA		MIP	2.5
MIL-W-81044/20	-65°C +150°C	600	26 - 8	TC	polyarylene	polyarylene	None	2.5
MIL-W-81044/21	-65°C +200°C	600	26 - 8	SPC	polyarylene	polyarylene	None	2.5
MIL-W-81044/22	-65°C +200°C	600	30 - 20	SPC alloy	polyarylene	polyarylene	None	2.5
MIL-W-81044/23	-65°C +260°C	600	26 - 8	NPC	polyarylene	polyarylene	None	2.5
MIL-W-81044/24	-65°C +260°C	600	30 - 20	NPC alloy	polyarylene	polyarylene	None	2.5
MIL-W-81044/25	-65°C +150°C	600	30 - 12	TC	polyarylene		None	2.5
MIL-W-81044/26	-65°C +200°C	600	30 - 12	SPC	polyarylene		None	2.5
MIL-W-81044/27	-65°C +200°C	600	30 - 20	SPC alloy	polyarylene		None	2.5
MIL-W-81044/28	-65°C +260°C	600	30 - 12	NPC	polyarylene		None	2.5
MIL-W-81044/29	-65°C +260°C	600	30 - 20	NPC alloy	polyarylene		None	2.5
MIL-W-81381/1	-65°C +200°C	600	26 - 10	SPC	FI pol tape		FEP dispersion	2.5
MIL-W-81381/2	-65°C +200°C	600	26 - 10	NPC	FI pol tape		FEP dispersion	2.5
MIL-W-81381/3	-65°C +200°C	600	26 - 2	SPC	FI pol tape		FEP dispersion* or TFE tape	2.5
MIL-W-81381/4	-65°C +200°C	600	26 - 2	NPC	FI pol tape		FEP dispersion* or TFE tape	2.5
MIL-W-81381/5	-65°C +200°C	600	26 - 20	SPC alloy	FI pol tape		FEP dispersion	2.5
MIL-W-81381/6	-65°C +200°C	600	26 - 20	NPC alloy	FI pol tape		FEP dispersion	2.5
MIL-W-81381/7	-65°C +200°C	600	26 - 10	SPC	FI pol tape		FEP dispersion	2.5
MIL-W-81381/8	-65°C +200°C	600	26 - 10	NPC	FI pol tape		FEP dispersion	2.5

California

1959 East Cashdan Street, Rancho Dominguez, CA 90220
 (310) 609-1811 • (800) 326-0006 • FAX: (310) 609-1862
 E-Mail: salesrd@std-wire.com

Arizona

3120 West Thomas Road, Bldg. #801, Phoenix, AZ 85017
 (602) 269-2501 • (800) 325-6478 • FAX: (602) 278-7134
 E-Mail: salesphx@std-wire.com



Standard Wire & Cable Co.

AWG MAXIMUM OUTSIDE DIAMETERS (see footnote *)																				
32	30	28	26	24	22	20	18	16	14	12	10	8	6	4	2	1	1/0	2/0	3/0	4/0
				0.056	0.065	0.073	0.083	0.093	0.112	0.130	0.160	0.220	0.271	0.328	0.412	N/A	0.506			
			0.050	0.056	0.065	0.073														
				0.047	0.054	0.062	0.073	0.082	0.099	0.116	0.142	0.203	0.251	0.311	0.386	N/A	0.482	0.542		
			0.042	0.047	0.054	0.062														
	0.026	0.029	0.034	0.039	0.045	0.054	0.064	0.072	0.090	0.108										
	0.026	0.029	0.034	0.039	0.045	0.054														
			0.042	0.047	0.054	0.062	0.073	0.082	0.099	0.116	0.142	0.203								
			0.042	0.047	0.054	0.062	0.073	0.082	0.099	0.116	0.142	0.203								
	0.034	0.037	0.042	0.047	0.054	0.062														
			0.042	0.047	0.054	0.062	0.073	0.082	0.099	0.116	0.142	0.203								
	0.034	0.037	0.042	0.047	0.054	0.062														
	0.026	0.029	0.034	0.039	0.045	0.054	0.064	0.072	0.090	0.108										
	0.026	0.029	0.034	0.039	0.045	0.054	0.064	0.072	0.090	0.108										
	0.026	0.029	0.034	0.039	0.045	0.054														
	0.026	0.029	0.034	0.039	0.045	0.054	0.064	0.072	0.090	0.108										
	0.026	0.029	0.034	0.039	0.045	0.054														
			0.040	0.043	0.050	0.058	0.067	0.074	0.089	0.108	0.131									
			0.040	0.043	0.050	0.058	0.067	0.074	0.089	0.108	0.131									
			0.049	0.054	0.060	0.068	0.079	0.087	0.099	0.117	0.141	0.210	0.250	0.308	0.378					
			0.049	0.054	0.060	0.068	0.079	0.087	0.099	0.117	0.141	0.210	0.250	0.308	0.378					
			0.040	0.042	0.049	0.057														
			0.040	0.042	0.049	0.057														
			0.034	0.037	0.044	0.052	0.062	0.068	0.082	0.101	0.124									
			0.034	0.037	0.044	0.052	0.062	0.068	0.082	0.101	0.124									

* Increase of outside diameters dependent on jacketing material used.

California

1959 East Cashdan Street, Rancho Dominguez, CA 90220
 (310) 609-1811 • (800) 326-0006 • FAX: (310) 609-1862
 E-Mail: salesrd@std-wire.com

Arizona

3120 West Thomas Road, Bldg. #801, Phoenix, AZ 85017
 (602) 269-2501 • (800) 325-6478 • FAX: (602) 278-7134
 E-Mail: salesphx@std-wire.com



Standard Wire & Cable Co.

Specifications	Operating Temperature	Oper. Voltage	AWG Size Range	Cond. Material	Primary Insulation	Secondary Insulation	Jacket	Dielectric Strength Min. KV
MIL-W-81381/9	-65°C +200°C	600	30 - 20	SPC alloy	FI pol tape		FEP dispersion	2.5
MIL-W-81381/10	-65°C +200°C	600	30 - 20	NPC alloy	FI pol tape		FEP dispersion	2.5
MIL-W-81381/11	-65°C +200°C	600	24 - 2	SPC	FI pol tape		Aromatic polyimide* or TFE tape	2.5
MIL-W-81381/12	-65°C +200°C	600	24 - 2	NPC	FI pol tape		Aromatic polyimide* or TFE tape	2.5
MIL-W-81381/13	-65°C +200°C	600	28 - 20	SPC alloy	FI pol tape		Aromatic polyimide	2.5
MIL-W-81381/14	-65°C +200°C	600	26 - 20	NPC alloy	FI pol tape		Aromatic polyimide	2.5
MIL-W-81381/15	CANCELED							
MIL-W-81381/16	CANCELED							
MIL-W-81381/17	-65°C +200°C	600	26 - 12	SPC	FI pol tape		Aromatic polyimide	2.5
MIL-W-81381/18	-65°C +200°C	600	26 - 12	NPC	FI pol tape		Aromatic polyimide	2.5
MIL-W-81381/19	-65°C +200°C	600	30 - 20	SPC alloy	FI pol tape		Aromatic polyimide	2.5
MIL-W-81381/20	-65°C +200°C	600	30 - 20	NPC alloy	FI pol tape		Aromatic polyimide	2.5
MIL-W-81381/21	-65°C +150°C	600	26 - 10	TC	FI pol tape	FI pol tape	Aromatic polyimide	2.5
MIL-W-81381/22	-65°C +150°C	600	24 - 2/0	TC	FI pol tape	FI pol tape	Aromatic polyimide resin or braid	2.5

* Increase of outside diameters dependent on jacketing material used.

California

1959 East Cashdan Street, Rancho Dominguez, CA 90220
(310) 609-1811 • (800) 326-0006 • FAX: (310) 609-1862
E-Mail: salesrd@std-wire.com

Arizona

3120 West Thomas Road, Bldg. #801, Phoenix, AZ 85017
(602) 269-2501 • (800) 325-6478 • FAX: (602) 278-7134
E-Mail: salesphx@std-wire.com



Standard Wire & Cable Co.

AWG MAXIMUM OUTSIDE DIAMETERS (see footnote *)																				
32	30	28	26	24	22	20	18	16	14	12	10	8	6	4	2	1	1/0	2/0	3/0	4/0
	0.026	0.029	0.034	0.037	0.044	0.052														
	0.027	0.030	0.034	0.037	0.044	0.052														
				0.044	0.049	0.057	0.067	0.073	0.086	0.105	0.127	0.206	0.251	0.306	0.378					
				0.045	0.050	0.058	0.068	0.074	0.087	0.107	0.129	0.206	0.251	0.306	0.378					
		0.035	0.040	0.045	0.051	0.059														
			0.040	0.045	0.051	0.060														
CANCELED																				
CANCELED																				
			0.030	0.035	0.041	0.049	0.058	0.065	0.078	0.098										
			0.030	0.035	0.041	0.050	0.059	0.066	0.080	0.099										
	0.024	0.027	0.030	0.035	0.041	0.050														
	0.024	0.027	0.030	0.035	0.042	0.050														
			0.034	0.038	0.045	0.053	0.063	0.069	0.083	0.102	0.125									
			0.044	0.049	0.058	0.068	0.074	0.089	0.107	0.130	0.206	0.251	0.306	0.378	N/A	0.461	0.578			

California

1959 East Cashdan Street, Rancho Dominguez, CA 90220
 (310) 609-1811 • (800) 326-0006 • FAX: (310) 609-1862
 E-Mail: salesrd@std-wire.com

Arizona

3120 West Thomas Road, Bldg. #801, Phoenix, AZ 85017
 (602) 269-2501 • (800) 325-6478 • FAX: (602) 278-7134
 E-Mail: salesphx@std-wire.com



Cable Design Formulas

WEIGHT OF CONDUCTOR:

- Weight** = $340.5 D^2 GNK$ = lbs./1,000 ft.
D = diameter of conductor in inches
G = specific gravity of conductor material; (8.89 for copper, 2.71 for aluminum)
N = number of strands
K = weight increase factor for stranded conductor. (**K** = 1 for solid conductor)

No. of strands	K
19	1.02
37	1.026
49	1.03
133 or more	1.04

WEIGHT OF INSULATION:

- Weight** = $340.5 (D^2 - d^2) G$ = lbs./1,000 ft.
D = diameter over insulation in inches
d = diameter over conductor in inches
G = specific gravity of insulation

WEIGHT OF JACKET:

- Weight** = $340.5 (D^2 - d^2) G$ = lbs./1,000 ft.
D = diameter over jacket in inches
d = diameter under jacket in inches
G = specific gravity of jacket material

WEIGHT OF TAPE:

- Weight** = $1362 Gt ((d+t)+(d+3t) f)$ = lbs./1,000 ft.
G = specific gravity of tape
t = tape thickness in inches
d = diameter of cable under tape in inches
f = multiplying factor from % lap

% Lap	f
17.5	0.35
25.0	0.5
33.0	0.67
50.0	1.0

TOTAL WEIGHT OF CABLED

CONDUCTOR:

- Weight** = $N \times L \times W$ = lbs./1,000 ft.
N = number of conductors
L = twisting loss factor = 1.03
W = weight of one conductor

CABLING FACTORS:

Number of Conductors	Factor	Number of Conductors	Factor
2	2.0	12	4.155
3	2.154	16	4.7
4	2.414	19	5.0
5	2.7	27	6.155
6	3.0	37	7.0
7	3.0	41	8.0
10	4.0	61	9.0

Use the following formula for other combinations:

$$O.D. = 1.155 \times (\text{Number of Conductors}) \times (\text{Diameter of Individual Conductor})$$

To determine the approximate O.D. of the finished cable, double the wall thickness of the wire, add this figure to the O.D. of the desired stranded conductor and multiply this dimension by the indicated factor for the number of conductors to be in the cable. Add 0.025" for a bare, tinned, or silver-plated copper shield of #36 gauge wire; e.g., 6 conductors of 24 gauge, 19/36 stranded, Type E wire with overall shield - 2×0.010 " (wall) = 0.020 " + 0.025 " (conductor O.D.) = 0.045 " (finished wire). Taking 0.045 " (finished wire) $\times 3$ (Factor for 6 conductors) = 0.135 ". Add the 0.135 " to the shield diameter of 0.025 " which yields a finished cable diameter (no jacket) of 0.160 ".

California

1959 East Cashdan Street, Rancho Dominguez, CA 90220
 (310) 609-1811 • (800) 326-0006 • FAX: (310) 609-1862
 E-Mail: salesrd@std-wire.com

Arizona

3120 West Thomas Road, Bldg. #801, Phoenix, AZ 85017
 (602) 269-2501 • (800) 325-6478 • FAX: (602) 278-7134
 E-Mail: salesphx@std-wire.com



Standard Wire & Cable Co.

PERCENT OF SHIELD COVERAGE:

$$\text{Percent coverage} = (2F - F^2) \times 100$$

- F** = $N P d / \text{Sin } (a)$
- N** = number of ends (strands) per carrier
- P** = picks per inch
- D** = diameter over dielectric core in inches
- d** = diameter of shielding strand in inches
- a** = the smaller of the two angles between the longitudinal axis of the cable and the lay of the braid.
- C** = number of carriers (groups of ends around the diameter of the cable) in a "two over" "two under" woven basket weave.
- p** = 3.14159265

$$\text{Tan } (a) = 2 p (D+2d) P / C$$

AWG Size	d (inches)	W (lbs./1,000 ft)
#40	0.0031	0.0291
#38	0.0040	0.0481
#36	0.0050	0.0757
#34	0.0063	0.120
#32	0.0080	0.194
#30	0.0100	0.303

DIAMETER OF SHIELD:

The formula to determine adders for diameter over the shield diameter of a multi-conductor cable is:

$$\text{Shield O.D.} = \text{diameter under shield} + \text{adder}$$

AWG Size (braid)	Adder (inches)
#40	0.014
#38	0.018
#36	0.022
#34	0.028
#32	0.035
#30	0.044
#28	0.056

PROPERTY VALUES (NOMINAL):

Material	Specific Gravity	K 1 Mc	Max. Oper. Temp. °C
TFE	2.15	1.95	260
FEP	2.15	2.15	200
Polyvinylidene flouride	1.76	7.5	125
FEP/polyimide film	1.67	2.35	200
Polyester film	1.40	2.80	150
Semirigid PVC	1.39	4.0	80
PVC	1.38	4.6	105
Neoprene®	1.38	-	60
EP rubber	1.30	3.7	105
Fire resistant polyethylene	1.29	2.7	80
Polyethylene/polyester film	1.26	2.80	105
Polysulfone	1.24	3.3	125
Polyurethane	1.12	-	80
Nylon	1.09	4.8	105
Polyethylene	0.92	2.26	80
Polypropylene	0.91	2.30	80
Cellular polyethylene	0.55	1.50	80

TWISTING LOSS:

Approximately 3% for all cables

WEIGHT OF SHIELD:

$$\text{Weight} = \frac{N \times C \times W}{\text{Cos } (a)} \times 1.03 = \text{lbs./1,000 ft.}$$

- N** = number of ends per carrier
- C** = number of carriers
- W** = weight of one of the shielding strands (lbs./1,000 ft.), see above
- a** = braid angle

Neoprene® is a trademark of the DuPont de Nemours Co.

California

1959 East Cashdan Street, Rancho Dominguez, CA 90220
(310) 609-1811 • (800) 326-0006 • FAX: (310) 609-1862
E-Mail: salesrd@std-wire.com

Arizona

3120 West Thomas Road, Bldg. #801, Phoenix, AZ 85017
(602) 269-2501 • (800) 325-6478 • FAX: (602) 278-7134
E-Mail: salesphx@std-wire.com



GLOSSARY OF WIRE & CABLE TERMINOLOGY

A

ABRASION - The destruction of a material caused by scraping or rubbing against a rough, hard surface.

ABRASION MACHINE - A laboratory device for determining the abrasion resistance of wire and cable. The two standard types of machines are the squirrel cage, with square steel bars, and the abrasive grit type.

ABRASION RESISTANCE - The ability of a wire or cable jacket to resist surface wear.

AC - Abbreviation for alternating current. See alternating current. Also abbreviated as ac.

ACCELERATED LIFE TEST - A test in which a cable is subjected to extreme conditions to determine the life of a cable.

ACCELERATOR - Chemical additive which hastens a chemical reaction, e.g., a compound added to rubber or Neoprene® mixtures to reduce curing time. Neoprene® is a trademark of the DuPont de Nemours Co.

ACR - Designation for cable with corona resisting insulation.

ACRS - Aluminum conductor, steel reinforced. Aluminum wires stranded around a steel core. Usually used for high voltage cross-country transmission lines.

ADAPTER - a) Device used for joining two fiber optic connectors together. b) A device for connecting two parts (of different diameters) of an apparatus.

ADHESIVE - Usually a synthetic material which, when applied to tapes, potting operations, etc., permits materials to be bonded together.

ADMITTANCE - Symbol Y . The reciprocal of impedance. Given by the formula:

$$Y = G + iB$$

where G is the conductance, B the susceptance, and i equals $\sqrt{-1}$. Since impedance, Z , is given by:

$$Z = R + iX$$

where R and X are the resistance and reactance, respectively, then:

$$Y = (R - iX) / (R^2 + X^2)$$

AEC - Atomic Energy Commission. The government agency which oversees all atomic energy projects.

AERIAL CABLE - A cable suspended in the air on poles or other overhead structures.

AIEE - Formerly American Institute of Electrical Engineers. Now called the Institute of Electrical and Electronic Engineers (IEEE).

AIR SPACED COAX - A coaxial cable in which air is basically the dielectric material. The conductor may be centered by means of a spirally wound synthetic filament, beads, or braided filaments. This construction is also referred to as an air dielectric.

AIRCRAFT IGNITION CABLE - A high tension cable designed for use in the ignition systems of internal combustion aircraft engines.

AIRCRAFT WIRE - An electrical wire primarily designed for the extreme conditions (temperature, altitude, solvents, fuels, etc.) of airborne equipment.

AL - Abbreviation for aluminum.

ALKALI - A soluble salt obtained from the ashes of plants and consisting largely of potassium or sodium carbonate.

ALL RUBBER CABLE - A cable in which all voids between conductors are filled with a rubber compound. This construction gives greater resistance to impact, adds strength, and reduces the tendency to kink. It also reduces flexibility.

ALLOY - A metal made by the fusion of two or more metals.

AL/MY - Abbreviation for Aluminum Mylar®. Sometimes called out as ALMY. Mylar® is a trademark of the DuPont de Nemours Co.

ALS - A type of cable consisting of insulated conductors enclosed in a continuous, closely fitting aluminum tube.

ALTERNATING CURRENT - An alternating current is one where the direction of current is reversed at regular intervals. The rate at which reversals occur is expressed in cycles per second (Hertz or Hz). Abbreviated as AC or ac.

California

1959 East Cashdan Street, Rancho Dominguez, CA 90220
(310) 609-1811 • (800) 326-0006 • FAX: (310) 609-1862
E-Mail: salesrd@std-wire.com

Arizona

3120 West Thomas Road, Bldg. #801, Phoenix, AZ 85017
(602) 269-2501 • (800) 325-6478 • FAX: (602) 278-7134
E-Mail: salesphx@std-wire.com



Standard Wire & Cable Co.

ALUMEL® - An alloy used for thermocouple and thermocouple extension wire. Alumel® is a trademark of the Hoskins Mfg. Co.

ALUMINUM CONDUCTOR - A wire or group of wires of aluminum, not insulated from each other, suitable for carrying electrical current.

am - Abbreviation for amplitude modulation. Also abbreviated as AM.

AMBIENT TEMPERATURE - The temperature of a medium (gas or liquid) surrounding an object.

AMERICAN WIRE GAUGE - Abbreviated AWG. See AWG.

AMP - Abbreviation for ampere. See Ampere.

AMPACITY - See current carrying capacity.

AMPERE - The unit expressing the rate of flow of an electrical current. One ampere is the current flowing through one ohm resistance with one volt potential. Abbreviated as amp.

AMPLIFIER - A device usually employing electron tubes or transistors to obtain amplification of voltage, current, or power.

AN - Literally "aircraft number". For example, AN-6 signifies a wire size of No. 6 AWG.

ANALOG - Being or relative to a mechanism in which data is represented by continuously varying physical quantities. Opposite - digital.

ANNEALED WIRE - Wire which has been softened by heating and gradually cooling. Also called soft drawn wire.

ANNULAR CONDUCTOR - An annular conductor consists of a number of wires stranded in three reverse concentric layers around a saturated hemp core.

ANODE - Positive pole of an electric source. Opposite - cathode.

ANSI - Abbreviation for American National Standards Institute. A federation of trade, technical, professional organizations, government agencies, and consumer groups. Coordinates standards development and publishes standards. Operates a voluntary certification program. Used to be called the American Standards Association (ASA).

ANTENNA WIRE - A wire usually of high tensile strength such as Copperweld®, bronze, etc., with or without insulation used as an antenna for radio and electronic equipment. Copperweld® is a trademark of the Copperweld Steel Company.

ANTIOXIDANT - A substance which prevents or slows down oxidation of material exposed to air.

APPROX. - Abbreviation for approximate.

ARAMID - A lightweight strong heat-resistant aromatic polyamide material used in fiber optic strength members.

ARMATURE WIRE - Stranded annealed copper wire, straight lay, soft loose white cotton braid. It is used for low voltage, high current rotor winding motors and generators. Straight lay permits forming in armature slots and compressibility.

ARMOR - An outer braid of metal or spiral steel tapes, primarily for the purpose of mechanical protection. Generally placed over the outer sheath.

AROMATIC - An organic material composed of benzene in a ring structure.

ARTOS STRIPPER - A machine that will automatically measure to a predetermined length, cut, strip, count, and tie wire in bundles.

ASA - Abbreviation for American Standards Association. Former name of the American National Standards Institute (ANSI). See ANSI.

ASESA - Abbreviation for Armed Services Electro Standards Agency.

ASG - Abbreviation for Aeronautical Standards Group.

ASME - Abbreviation for American Society of Mechanical Engineers.

ASTM - Abbreviation for American Society for Testing Materials. An organization that tests materials and attempts to set standards on various materials for industry.

ATTENUATION - The loss of power or signal in a circuit, generally expressed in decibels (dB) per unit length, usually one thousand (1,000) feet. In optical fiber cables, attenuation is the ratio of input power vs. output power, measured in decibels per unit length, usually dB/km. Abbreviated as attn.

ATTN. - Abbreviation for attenuation. See attenuation.

AUDIO FREQUENCY - The range of frequencies audible to the human ear, approximately 20 to 20,000 Hz.

AUTO PRIMARY WIRE - A single or multi-conductor wire used for original equipment or replacement on automotive products. Normally low voltage, resistant to oil, acid, and weather.

AWG - Abbreviation for American Wire Gauge. The system most commonly used in the United States for describing the size of copper wire. It is based on the circular mil system. One (1) mil equals 0.001 inch. Also referred to as the Brown and Sharpe (B&S) wire gauge.

AWM - Designation for appliance wiring material.

California

1959 East Cashdan Street, Rancho Dominguez, CA 90220
(310) 609-1811 • (800) 326-0006 • FAX: (310) 609-1862
E-Mail: salesrd@std-wire.com

Arizona

3120 West Thomas Road, Bldg. #801, Phoenix, AZ 85017
(602) 269-2501 • (800) 325-6478 • FAX: (602) 278-7134
E-Mail: salesphx@std-wire.com



B

B - Symbol for susceptance. See susceptance.

B & S GAUGE - Brown and Sharpe wire gauge used for describing different sizes of copper conductors. It is the same as AWG (American Wire Gauge). See AWG.

BACKBONE - A transmission network that carries information in a fiber optic system. Mainly for indoor applications between floors and areas with different types of cables.

BACKSHELL MOLD - An aluminum mold used to mold a rubber or Neoprene® covering over the backshell of a conductor or plug after it is connected to a cable. The compound is usually chemically cured. Neoprene® is a trademark of the DuPont de Nemours Co.

BALCO® - An alloy of 70% nickel and 30% iron. It is used in devices where self-regulation by temperature is required. Wilbur Driver Company trademark for a resistance wire.

BAND MARKING - A circular band applied at regular intervals to the insulation of a conductor for the purpose of color coding or circuit identification.

BANDED CABLE - Two or more cables which have been banded together by stainless steel strapping.

BANDWIDTH - The frequency range of transmitted electrical or optical signals, expressed in Hertz. The greater or higher the bandwidth, the greater the information carrying capacity.

BARE CONDUCTOR - A conductor not covered with any insulating material.

BASE BAND - The frequency band occupied by all the transmitted modulating signals.

BASE PRICE - The price of copper per pound before any adders are applied. To this base price, adders are used to determine price for drawing the copper into a wire and for tinning or insulating the bare copper wire.

BATTERY CABLE - A single conductor cable either insulated or uninsulated used for carrying current from batteries to the point where power is needed. May also be used for grounding.

BAUD - Unit of measure for data transmission speed representing bits per second, e.g., 9,600 baud = 9,600 bits per second (bps).

BC - Abbreviation for bare copper.

2BC - Abbreviation for double bare copper shield.

BCCS - Abbreviation for bare copper-clad steel.

BC-S - Abbreviation for double shield; 1 bare copper, 1 silver.

BEADED COAX - A coaxial cable in which the dielectric consists of beads made of various materials.

BELL WIRE - Common term for wire primarily used for making doorbell and thermostat connections.

BELT (BELTED TYPE CABLE) - Refers to the number of layers of insulation on a conductor or number of layers of jacket on a cable.

BEND RADIUS - The radius of curvature that an optical fiber cable can bend without causing harmful effects on the optical or mechanical performance of the cable.

BENDING LOSS - In a fiber optic system a form of increased attenuation caused by: a) Having the fiber curved around a restrictive radius of curvature; or b) Microbends caused by minute distortions in the fiber imposed by externally induced disturbances. Excessive bending loss may result from poor drawing or cable manufacturing technique.

BENDING RADIUS - Radius of curvature around which a fiber is bent under a stated pulling force.

BerC - Abbreviation for beryllium-copper alloy.

BIAS - a) A voltage applied to a device to establish a reference level for operation. b) A high frequency voltage combined with an audio signal to reduce distortion.

BINDER - A spirally served tape or thread used for holding assembled cable components in place awaiting subsequent manufacturing operations.

BLASTING WIRE - Wire used for detonating explosives. It is usually a very inexpensively constructed wire.

BLK - Abbreviation for black.

BMS - Abbreviation for Boeing Material Specification.

BOND STRENGTH - Amount of adhesion between bonded surfaces, e.g., in cemented ribbon cable.

BONDABLE WIRE - An insulated wire whose surface has been specially treated to make it possible to adhere to other materials such as potting compounds. The term usually refers to extruded Teflon® insulated wires. The etching process roughens the surface of the insulation permitting an interlocking effect with potting compounds. Teflon® is a trademark of the DuPont de Nemours Co.

BONDED CONSTRUCTION - A type of insulation construction in which the glass braid and nylon jacket are bonded together as in certain wire sizes of MIL-W-5086 Type II.

BOOT - A protective covering over any portion of a cable or conductor in addition to its jacket or insulation.

BPS - Abbreviation for bits per second.

California

1959 East Cashdan Street, Rancho Dominguez, CA 90220
(310) 609-1811 • (800) 326-0006 • FAX: (310) 609-1862
E-Mail: salesrd@std-wire.com

Arizona

3120 West Thomas Road, Bldg. #801, Phoenix, AZ 85017
(602) 269-2501 • (800) 325-6478 • FAX: (602) 278-7134
E-Mail: salesphx@std-wire.com



Standard Wire & Cable Co.

BRAID - A fibrous or metallic group of filaments interwoven in cylindrical form to form a covering over one or more wires. It can be made of materials such as cotton, glass, nylon, or copper fibers. Usually fibrous braid is saturated with an impregnant to protect it against moisture and fraying.

BRAID ANGLE - The smaller of the two angles formed by the shielding strand and the axis of the cable being shielded.

BRAIDED WIRE - Woven bare or tinned copper wire used as shielding for wires, cables, and ground wire for batteries or heavy industrial equipment. There are many different types of constructions.

BRAKE WIRE - Wires used in the manufacture of both home and truck trailers to supply current to the electrical brakes on the equipment.

BRAZING - The joining of the end of two wires, rods, or groups of wires with a nonferrous filler metal at temperatures above 427° C (800° F).

BREAKDOWN (PUNCTURE) - A disruptive discharge through the insulation.

BREAKDOWN OF INSULATION - Failure of an insulation resulting in a flow of current through the insulation. It may be caused by the application of too high a voltage or defects or decay in the insulation.

BREAKDOWN VOLTAGE - The voltage at which the insulation between two conductors breaks down.

BREAKING STRENGTH - The maximum load that a conductor can withstand when tested in tension to rupture. This force is usually expressed in pounds (lbs) or kilograms (kgs).

BREAKOUT - A breakout is a joint where a conductor or conductors break out from a multi-conductor cable to complete circuits at various points along the main cable. The rest of the conductors continue on within the jacket. The breakout may itself be jacketed and the joint sealed.

BROADBAND - A frequency band that extends over a relatively large range.

BUFFER (TUBE) - Metallic or nonmetallic tube used to protect optical fibers from physical damage, providing mechanical isolation and/or protection.

BUILDING WIRE - Commercial wires used in the building trades such as: Types RR, RH, RL, TW, THW, and THHN wires. General used for light and power, 600 volts or less, usually not exposed to outdoor environment.

BUNA RUBBER - A synthetic rubber used as a replacement for natural rubber.

BUNCH STRANDING - A conductor in which all individual wires are twisted in the same direction without a predetermined pattern.

BURIAL CABLE - A cable installed directly in the earth without use of an underground conduit. Also called "direct burial cable."

BUS (BUS BAR) - A conductor, often a heavy strap or bar, used to make a common connection between several circuits.

BUTT BRAIDER - A machine used for braiding or shielding cable or wire. It may be 8, 16, 24, 32, 48, or 64 carriers. These braiders are manufactured by New England Butt Company and operate on the maypole type principal.

BUTYL - Used for any of various synthetic rubbers made by polymerizing isobutylene.

BX - A very common type of armored building wire in various configurations, rated at 600 volt.

C

c - Abbreviation for centimeter. Also abbreviated cm.

C - Abbreviation for Centigrade. A scale for measuring temperature, water freezes at 0° C and boils at 100° C. See Celsius temperature scale.

CABLE - a) A cable may be a small number of large conductors or a large number of small conductors, cabled together, usually color coded and with a protective jacket overall. b) A single conductor larger than 9 AWG.

CABLE ASSEMBLY - A cable assembly is a cable with plugs or connectors on each end for a specific purpose. It may be formed in various configurations.

CABLE CORE - The portion of an insulated cable lying under the protective covering or jacket.

CABLE FILLER - The material used in multi-conductor cables to occupy the spaces formed by the assembly of components thus forming a core of the desired shape (normally cylindrical).

CABLE PULLERS - A cable puller is a tool for pulling cables through a conduit made of metal, plastic, rubber, or Neoprene®. Neoprene® is a trademark of the DuPont de Nemours Co.

CABLE SHEATH - A cable sheath is a covering of rubber, Neoprene®, resin, or lead over a wire or cable core. Neoprene® is a trademark of the DuPont de Nemours Co.

CABLING FACTOR - Symbol K. A constant used in determining the approximate finished O.D. of an unshielded, unjacketed cable. $D = Kd$, where **D** is the diameter, **K** is the factor, and **d** is the diameter of one insulated conductor. A separate constant is used based on the number of conductors used (see Cable Design Formulas page 214).

CAD BR - Abbreviation for cadmium bronze.

California

1959 East Cashdan Street, Rancho Dominguez, CA 90220
(310) 609-1811 • (800) 326-0006 • FAX: (310) 609-1862
E-Mail: salesrd@std-wire.com

Arizona

3120 West Thomas Road, Bldg. #801, Phoenix, AZ 85017
(602) 269-2501 • (800) 325-6478 • FAX: (602) 278-7134
E-Mail: salesphx@std-wire.com



Standard Wire & Cable Co.

CADMIUM - A bluish-white malleable ductile toxic bivalent metallic element used in protective platings and in bearing metals.

CAGED ARMOR - The armor wires within a polyethylene jacket to increase mechanical protection and tensile strength. Often used in submarine cables.

CAL-TRANS - Abbreviation for California Department of Transportation.

CAP - Abbreviation for capacitance. See capacitance.

CAPACITANCE - Capacitance is that property of a system of conductors and dielectrics which permits the storage of electricity when potential differences exist between the conductors. The value depends largely on the surface area of the plates, distance between them, and the composition of the medium between the plates. Abbreviation CAP. The unit of measure is farad (f).

CAPACITANCE, DIRECT - The capacitance measured directly from conductor to conductor through a single insulating layer.

CAPACITANCE, MUTUAL - The capacitance between two conductors with all other conductors, including shield, short-circuited to ground.

CAPACITANCE, UNBALANCED - An inequality of capacitance between the wires of two or more pairs which results in a transfer of unwanted signal from one pair to others.

CAPACITANCE, UNBALANCED TO GROUND - An inequality of capacitance between the ground capacitance of the conductors of a pair which results in a pick up of external source energy, usually from power transmission lines.

CAPACITIVE COUPLING - Electrical interaction between two conductors caused by the capacitance between them.

CATEGORY 1 - A UL designation for inside telephone cable for voice and low-speed data applications. Also referred to as Level 1.

CATEGORY 2 - A UL designation for inside telephone cable for voice and low-speed data applications. Also referred to as Level 2.

CATEGORY 3 - A UL designation for inside telephone cable that is the lowest performance level recommended for voice or data use. Also referred to as Level 3.

CATEGORY 4 - A UL designation for inside telephone cable that is the highest performance level available UTP or Data Grade UTP. Also referred to as Level 4.

CATEGORY 5 - A UL designation for inside telephone cable that is the lowest performance level recommended for Data Grade UTP. Also referred to as Level 5.

CATHODE - Negative pole of an electric source. Opposite - anode.

CATV - Abbreviation for Community Antenna Television.

CBO - Brewery cord, Neoprene® insulated. Neoprene® is a trademark of the DuPont de Nemours Co.

CCA - Abbreviation for copper-clad aluminum.

CCS - Abbreviation for copper-clad steel. See copper-clad.

CCTV - Abbreviation for Closed Circuit Television.

CDDI - Abbreviation for cable distributed data interface.

CEC - Abbreviation for Canadian Electrical Code.

CELLULAR POLYETHYLENE - Expanded or "foam" polyethylene consisting of individual closed cells suspended in a polyethylene medium.

CELSIUS TEMPERATURE SCALE - Formerly called Centigrade Temperature Scale. A temperature scale based upon the freezing point of water defined as 0° C and the boiling point defined as 100° C.

CENTI - A prefix to a unit, denoting a submultiple of one-hundredth (10^{-2}) of that unit.

CENTIGRADE TEMPERATURE SCALE - The older name for the Celsius Temperature Scale in English speaking countries. Officially abandoned by international agreements and the U.S. Bureau of Standards in 1948, but still in common usage.

CERTIFICATE OF COMPLIANCE (CONFORMANCE) - A certificate which is normally generated by a quality control department which shows that the product being shipped meets the customer's specifications. Abbreviation C of C, sometimes referred to as CERTS.

CERTIFIED TEST REPORTS - A report providing actual test data on a cable. Tests are normally run by a quality control department which show that the product being shipped conforms to test specifications. Abbreviation CTR or TR.

CERTS - Abbreviation for certificate of compliance. See certificate of compliance.

CF - The designation for cotton fixture wire. It is a cotton insulated, impregnated with moisture resisting, flame-retardant compound. It is used in lighting fixtures up to 90° C.

CF GLASS - Means continuous filament glass yarn which is used in braiding, in making glass fabric, and glass thread.

CFT - The abbreviation for 100 feet.

CHARACTERISTIC IMPEDANCE - a) The impedance that when connected to the output terminals of a transmission line of any length, makes the line appear infinitely long. b) The ratio

California

1959 East Cashdan Street, Rancho Dominguez, CA 90220
(310) 609-1811 • (800) 326-0006 • FAX: (310) 609-1862
E-Mail: salesrd@std-wire.com

Arizona

3120 West Thomas Road, Bldg. #801, Phoenix, AZ 85017
(602) 269-2501 • (800) 325-6478 • FAX: (602) 278-7134
E-Mail: salesphx@std-wire.com



Standard Wire & Cable Co.

of voltage to current at every point along a transmission line on which there are no standing waves.

CHEMICALLY CURED COMPOUND - Those compounds which are cured by chemical process rather than by heat and pressure.

CHLORO - Abbreviation for chloroprene. See chloroprene.

CHLOROPRENE - A colorless liquid C_4H_5Cl . Abbreviated as chloro.

CHLOROSULFONATED POLYETHYLENE - A synthetic rubber, made by DuPont de Nemours Co. Resistant to oxidation by ozone, sun, weather, heat, and chemicals, rated 90° C. Abbreviated CP or CSPE. Trade name is Hypalon® which is a trademark of the DuPont de Nemours Co.

CHROMATIC DISPERSION - Different wavelengths travel along an optical medium at different speeds. Wavelengths reach the end of the medium at different times, causing the light pulse to spread. This chromatic dispersion is expressed in picoseconds (of dispersion) per kilometer (of length) per nanometer (of source bandwidth). It is the sum of material and waveguide dispersion.

CHROMEL®-ALUMEL® - The alloy used in making Chromel-Alumel® thermocouple wires. Chromel® is an alloy of nickel and chrome plus nine other elements. Alumel® is an alloy containing nickel, manganese, aluminum, silicon, and nine other elements. Chromel® is nonmagnetic; Alumel® is highly magnetic. Chromel® and Alumel® are trademarks of the Hoskins Mfg. Co.

CHROMIUM - A blue-white metallic element found naturally only in combination and used in alloys and in electroplating.

CIRCUIT (ELECTRIC) - The complete path of an electrical current. When the continuity of the circuit is broken, it is called an open circuit; when continuity is maintained, it is called a closed circuit.

CIRCUIT SIZES - A popular term for building wires sizes 14 through 10 AWG.

CIRCULAR MIL - A term universally used to define cross sectional areas of conductors. It is an area (7.854×10 sq. in.) equal to the area of a circle one-thousandth (10^{-3}) of an inch in diameter. As the number of circular mils increases, the size of a wire increases. Abbreviation CM.

CL2 - Abbreviation for Class 2 cable.

CL2P - Abbreviation for Class 2 plenum cable.

CL2R - Abbreviation for Class 2 riser cable.

CL2X - Abbreviation for Class 2 cable, limited use.

CL3 - Abbreviation for Class 3 cable.

CL3P - Abbreviation for Class 3 plenum cable.

CL3R - Abbreviation for Class 3 riser cable.

CL3X - Abbreviation for Class 3 cable, limited use.

CLADDING - a) In fiber optics the layer of material, usually glass, that immediately surrounds the fiber core of optical fiber cable. The cladding is usually coated with another material to provide protection when handling. b) A method of applying a layer of metal over another metal whereby the junction of the two metals is continuously welded.

CLEAVING - The process of separating an optical fiber by a controlled fracture of the glass, for the purpose of obtaining a fiber end, which is flat, smooth, and perpendicular to the fiber axis.

cm - Abbreviation for centimeter. Also abbreviated c.

CM - a) Abbreviation for communication general purpose cable. b) Abbreviation for circular mil. See circular mil.

CMP - Abbreviation for communication plenum cable.

CMR - Abbreviation for communication riser cable.

CMX - Abbreviation for communication cable, limited use.

COATING - A material applied to the surface of a conductor to prevent environmental deterioration, facilitate soldering, or improve electrical performance.

COAX - See coaxial cable.

COAXIAL CABLE - A cable in which one conductor completely surrounds the other, the two being coaxial and separated by a continuous solid dielectric or by dielectric spacers. When the outside conductor is grounded, the inside conductor is not susceptible to external fields from outside sources. Commonly called coax.

COIL - A coiled conductor, wound on a form or core which uses electromagnetic induction to cause changes in a current.

COLD BEND - Generally refers to a test to determine cable or wire characteristics at low temperatures. The test specimen and a specified mandrel are cooled in a low temperature box to the specified temperature. The wire specimen is then wound around the mandrel after which it is examined for cracks or other defects caused by bending at low temperatures.

COLD FLOW - Permanent deformation of the insulation due to mechanical force or pressure (not due to heat softening).

COLD TEST - Tests performed on cables to check their performance at a specified low temperature as outlined in various specifications.

COLOR CODE - Color code is the use of different colored insulated wires for purposes of identification in a multi-conductor cable.

California

1959 East Cashdan Street, Rancho Dominguez, CA 90220
(310) 609-1811 • (800) 326-0006 • FAX: (310) 609-1862
E-Mail: salesrd@std-wire.com

Arizona

3120 West Thomas Road, Bldg. #801, Phoenix, AZ 85017
(602) 269-2501 • (800) 325-6478 • FAX: (602) 278-7134
E-Mail: salesphx@std-wire.com



Standard Wire & Cable Co.

COMMON AXIS CABLING - In multiple cable constructions, a twisting of all conductors around a "common axis" with two conductor groups then selected as pairs. This method yields smaller diameter constructions than does a separate axis construction, but tends to yield greater susceptibility to EMI and ESI.

COMMUNITY TV CABLE - Community TV cables are coaxial cables that are used to transmit television signals from a master antenna to a group of receivers in a community. RG 17/U is used as the primary lead-in, RG 11/U as the secondary lead-in, and RG 59/U as the tap-off lead-in.

COMPACT CONDUCTOR - Refers to a stranded conductor which is rolled to deform the round wires to fill the normal interstices between the wires in a strand.

COMPOSITE CABLE - A cable consisting of two or more different types or sizes of wire and/or cable.

COMPOUND - An insulating or jacketing material made by the chemical union of two or more ingredients.

CONCENTRIC LAY CONDUCTOR - A single conductor composed of a central core surrounded by one or more helically laid wires. Each of these succeeding layers is applied with an opposite direction twist. The number of wires laid up the center wire is six, and each succeeding layer consists of six additional wires so that the number of wires in the strands are 7, 19, 37, 61, etc.

CONCENTRIC STRANDING - A central wire or core surrounded by one or more layers of helically wound strands in a fixed round geometric arrangement. Generally each layer, after the first, has six more strands than the preceding layer and is applied in a direction opposite to that of the layer under it.

CONCENTRICITY - In a wire or cable, the measurement of the location of the center of the conductor with respect to the geometric center of the surrounding insulation.

COND. - Abbreviation for conductor. See conductor.

CONDUCTANCE - Symbol G . The measure of the ability of a substance to conduct electricity. The ratio of the current flow to the potential difference causing the flow. The real part of the admittance, Y , which is given by:

$$Y = G + iB$$

where B is the susceptance and i equals $\sqrt{-1}$.

For a direct current circuit, the conductance is the reciprocal of resistance and is measured in ohms. For a circuit containing both resistance, R , and reactance, X , the conductance is given by:

$$G = R / (R^2 + X^2)$$

CONDUCTIVITY - The capability of a material to carry electrical current, usually expressed as a percentage of copper conductivity (copper being 100%). The reciprocal of resistivity.

CONDUCTOR - A material that offers a low resistance to the passage of electric current (see resistivity). When a potential difference is applied across it, a relatively large current flows. A conductor usually consists of copper, aluminum, steel, silver, or other materials. Abbreviated as cond.

CONDUIT - A tube or trough for protecting electrical wires or cables.

CONNECTOR - A mechanism used to unite two pieces of cable, both physically and electrically.

CONSERVATION OF ENERGY PRINCIPLE - A principle in physics; the total energy of an isolated system remains constant irrespective of whatever internal change may take place with energy disappearing in one form and reappearing in another.

CONST. - Abbreviation for construction.

CONSTANTAN - An alloy of 55% copper and 45% nickel used in thermocouple with copper in the temperature range of 169° C to 386° C. Temperature coefficient of electrical resistivity, 0.0002 / ° C.

CONT. - Abbreviation for continued.

CONTACT - The part of a conductor which actually carries the electrical current and is touched together or separated to control flow.

CONTINUITY CHECK - A test performed on a length of finished wire or cable to determine if the electrical current flows continuously throughout the length. Each conductor may also be checked against each other to ascertain that no shorts exist between conductors.

CONTINUOUS DUTY - In some portable cords there are two standard number of strands of a given wire size. The one with the greater number (most flexible) is called continuous duty and the other is called stationary duty.

CONTINUOUS VULCANIZATION - The process of extruding on a wire, under high pressure, a uniform seamless, close-fitting tube of a rubber or rubberlike compound. The covered wire then continues into a vulcanizing chamber, where, under high pressure and temperature, the insulation or jacket is vulcanized continuously rather than in sections. Abbreviated as cv.

CONTROL CABLE - A cable used for remote control operation of any type of electrical power equipment.

COPO - Abbreviation for copolene. See copolene.

COPELENE - Copolene is a dielectric material used in manufacturing coaxial cable. Developed as a substitute for polysty-

California

1959 East Cashdan Street, Rancho Dominguez, CA 90220
(310) 609-1811 • (800) 326-0006 • FAX: (310) 609-1862
E-Mail: salesrd@std-wire.com

Arizona

3120 West Thomas Road, Bldg. #801, Phoenix, AZ 85017
(602) 269-2501 • (800) 325-6478 • FAX: (602) 278-7134
E-Mail: salesphx@std-wire.com



Standard Wire & Cable Co.

rene, it is composed of polystyrene and polyisobutylene. Since it has undesirable characteristics, it has been replaced by polyethylene. Abbreviated as copo.

COPOLYMER - A compound resulting from the polymerization of two different monomers.

COPPER-CLAD - Steel wire with a coating of copper welded to it, as distinguished from copper-plated. Abbreviated CCS. Same as Copperweld®. Copperweld® is a trademark of the Copperweld Steel Company.

COPPER CONSTANTAN - Copper and constantan are two materials used in making thermocouple wires. The copper is the positive wire and the constantan is the negative wire.

COPPERWELD® - Copperweld® is the trade name for copper covered steel wire manufactured by Copperweld Steel Company. It is made by an exclusive molten welding process whereby a thick copper covering is inseparably welded to a steel core. Copperweld® thus performs as one metal. Hot rolling, cold drawing, pounding, or temperature changes cannot adversely affect it. Abbreviated as cw.

CORD - A small, flexible insulated conductor or conductors, usual 10 AWG or smaller and not more than four conductors, jacketed to protect the conductors, and most often used for portable applications.

CORD SETS - Portable cords fitted with any type of wiring device at one or both ends.

CORE - a) In cables, a component or assembly of components over which additional components (shield, sheath, etc.) are applied. b) In fiber optic cable, the central part of the glass construction through which light is transmitted.

CORONA - Ionization of air surrounding a conductor caused by the influence of high voltage.

CORPS OF ENGINEERS - The branch of the United States Army in charge of construction on all military installations.

COVERAGE - The percent of completeness with which a metal braid covers the underlying surface.

COVERINGS - Coverings may consist of textile braids or may be jackets of rubber, plastics, or other materials applied over wires and cables. Such coverings provide mechanical protection and, in some cases, circuit identification.

CP - Abbreviation for chlorosulfonated polyethylene. Also abbreviated as CSPE. See Hypalon®. Hypalon® is a trademark of the DuPont de Nemours Co.

CPC - Abbreviation for copper polyester copper laminate.

CPE - Abbreviation for chlorinated polyethylene, a conductive polyethylene.

CPVC - Abbreviation for chlorinated polyvinylchloride.

CR - Abbreviation for chloroprene rubber. See Neoprene®. Neoprene® is a trademark of the DuPont de Nemours Co.

CRAZING - The minute cracks on the surface of plastic materials.

CRCS - Abbreviation for continuous rigid cable support, synonymous with tray.

CREEPAGE - Electric leakage on a solid dielectric surface.

CROSS-LINKED - Intermolecular bonds between long chain thermoplastic polymers by means of chemical or electron bombardment. The properties of the resulting thermosetting material are usually improved. Abbreviation XL.

CROSS SECTIONAL AREA OF A CONDUCTOR - Cross sectional area of a conductor is the sum of cross sectional areas of all the individual wires comprising the strand.

CROSS TALK - Signal interference due to cross coupling between nearby conductors producing an unwanted signal in one circuit when a signal is present in the other. A phenomenon usually due to induction.

CSA - Abbreviation for Canadian Standards Association. This is the Canadian counterpart of the Underwriters Laboratories (UL) in the U.S.

CSPE - Abbreviation for chlorosulfonated polyethylene. Also abbreviated as CP. See Hypalon®. Hypalon® is a trademark of the DuPont de Nemours Co.

CURE DATE - a) The date at which the curing cycle is completed on Neoprene® or rubber. b) The date of manufacture. Neoprene® is a trademark of the DuPont de Nemours Co.

CURRENT - The rate of flow of electricity. Usually measured in amperes. Symbol I.

CURRENT CARRYING CAPACITY - The maximum current an insulated conductor can continuously carry without exceeding its insulation and jacket temperature limitations. Also called ampacity.

CUTOFF WAVELENGTH - In fiber optics cable, the wavelength at which a single-mode fiber transmits a single-mode of light.

CV - The abbreviation for continuous vulcanization. See continuous vulcanization.

CW - Abbreviation for Copperweld® conductor. See Copperweld®. Copperweld® is a trademark of the Copperweld Steel Company.

CYCLE - The complete sequence of alteration or reversal of the flow of an alternating electric current.

California

1959 East Cashdan Street, Rancho Dominguez, CA 90220
(310) 609-1811 • (800) 326-0006 • FAX: (310) 609-1862
E-Mail: salesrd@std-wire.com

Arizona

3120 West Thomas Road, Bldg. #801, Phoenix, AZ 85017
(602) 269-2501 • (800) 325-6478 • FAX: (602) 278-7134
E-Mail: salesphx@std-wire.com



D

db - Abbreviation for decibel(s). See decibel.

db LOSS - The loss of signal over a path or conductor, expressed in decibels.

DC - Abbreviation for direct current. See direct current. Also abbreviated dc.

DCR - Abbreviation for direct current resistance. The resistance offered by any circuit to the flow of direct current.

DEC - Abbreviation for Digital Equipment Corporation.

DECA - A prefix to a unit, denoting a multiple of ten (10) of that unit.

DECI - A prefix to a unit, denoting a submultiple of one-tenth (10^{-1}) of that unit.

DECIBEL - A unit used to express ratios of sound or signal power, defined by the following formula where **n** is the number of decibels.

$$n = 10 \log_{10} \left(P_2 / P_1 \right)$$

Where **P₁** and **P₂** are the power levels. Since decibels represent a ratio, it is necessary to establish a reference level in order to indicate an absolute level. For sound, the reference level is a pressure of 0.0002 microbar. Abbreviated as db.

DEGREE RISE - The amount of increase in temperature caused by the introduction of electricity into a unit.

DELAY LINE - A conductor that is made of a specific material in a specific size and length that will permit the delay of an electrical impulse for a predetermined specific length of time. The delay is measured in microseconds or nanoseconds.

DENSITY - The distribution of a quantity (as mass, electricity, or energy) per unit, usually of space.

DESICCANT - Water or moisture absorbent material used to prevent moisture from damaging packaged equipment or other merchandise.

DESIGN VOLTAGE - Voltage at which a cable is designed for maximum work.

DETECTA-DUCT® - Traffic signal inductance loop detector wire. Detecta-Duct® is a trademark of the Standard Wire & Cable Co.

DIA. - Abbreviation for diameter.

DIELECT. - Abbreviation for dielectric. See dielectric.

DIELECTRIC - Any insulating material that is a nonconductor of electricity. Abbreviated as dielect.

DIELECTRIC ABSORPTION - That property of an imperfect dielectric whereby there is an accumulation of electric charge within the body of the material when it is placed in an electric field.

DIELECTRIC CONSTANT - The factor by which the electric field strength in a vacuum exceeds that in the dielectric for the same distribution of charge. Symbol **K**. The **K** for air is 1.0.

DIELECTRIC LOSS - Energy dissipated as heat when the dielectric is placed in a varying electric field.

DIELECTRIC STRENGTH - The maximum potential gradient (volts per mil) a dielectric will stand without breaking down; the voltage stress required to puncture an insulation of known thickness (in volts per unit, usually volts per mil.)

DIGITAL - Of or relating to calculation by numerical methods or by discrete units. Opposite - analog.

DIODE - Any electronic device that has only two electrodes. There are several different types of diodes, their voltage characteristics determining their application. Diodes are most commonly used as rectifiers.

DIRECT BURIAL CABLE - A cable installed directly in the earth without use of an underground conduit. Also called "burial cable".

DIRECT CURRENT - A direct current is one which flows in one direction. Further classifications of direct currents are: a) Continuous currents which are steady, nonpulsating direct currents; b) Constant currents, which continue to flow for a considerable time in the same direction and with unvarying intensity; and c) Pulsating currents, which are regularly varying continuous currents. Abbreviations DC and dc.

DIRECTION OF LAY - The lateral direction in which the strands of a cable run over the top of the cable as they recede from you looking along the axis of the cable.

DISPERSION - A general term for those phenomena that cause a broadening or spreading of light as it propagates through an optical fiber. The three types are modal, chromatic, and waveguide.

DOD - Abbreviation for the U. S. Department of Defense.

DOUBLE SHIELD - Two shields, one over the other. Maximum coverage is 98%.

DP - Abbreviation for data processing.

DRAIN WIRE - An uninsulated solid or stranded tinned copper wire which is placed directly under a shield. It touches the shield throughout the cable, and, therefore, may be used in terminating the shield to ground. A big labor saver in terminating all shielded cables. It is completely necessary on spiral

California

1959 East Cashdan Street, Rancho Dominguez, CA 90220
(310) 609-1811 • (800) 326-0006 • FAX: (310) 609-1862
E-Mail: salesrd@std-wire.com

Arizona

3120 West Thomas Road, Bldg. #801, Phoenix, AZ 85017
(602) 269-2501 • (800) 325-6478 • FAX: (602) 278-7134
E-Mail: salesphx@std-wire.com



Standard Wire & Cable Co.

shielded cables because it eliminates the possibility of induction in a spiral shield.

DRAWING - In wire manufacturing, pulling of metal through a die or series of dies to reduce diameter to a specific size.

DROP CABLE - In a CATV system, the transmission cable from the distribution cable to a dwelling.

DUCT - An underground or overhead tube for carrying electrical conductors.

DUPLEX - Two conductors twisted together, usually with no outer covering. This word has a double meaning and it is possible to have parallel wires and jacketed parallel wires and still refer to them as a duplex.

E

EARTH FAULT - A fault that occurs when a conductor is accidentally connected to earth or when the resistance to earth of an insulator falls below a specific value.

EARTH POTENTIAL - The potential of a large conducting body, such as the earth, taken to be the arbitrary zero in the scale of electrical potential. Synonymous with zero potential.

ECM - Abbreviation for Electronic Counter Measure. The use of equipment to prevent or induce jamming of electronic equipment, missile systems, radar, radio, and other devices.

ECTFE - Abbreviation for ethylene chlorotrifluoroethylene copolymer. See ethylene chlorotrifluoroethylene. Trade name Halar®. Halar® is a trademark of the Allied Chemical Co.

EEA - Abbreviation for ethylene-ethyl acrylate copolymer.

EHF - Abbreviation for extremely high frequency. See frequency band.

EIA - Abbreviation for Electronics Industries Association. Formerly know as RETMA (Radio Electronics Television Manufacturers Association).

ELASTOMER - A rubberlike substance.

ELECTRICAL DUCT - Any electrical conduit or other raceway round in cross section, approved or listed for use underground, and embedded in earth or concrete.

ELECTRO TINNED - Wire tinned with pure tin using an electrolytic process.

ELECTROMOTIVE FORCE - Pressure or voltage. The force which causes current to flow in a circuit. The algebraic sum of the potential differences in a circuit equals the EMF, which is measured by the energy liberated when unit electric charge passes completely round the circuit. A battery of EMF, **E**, will supply a current, **I**, to an external resistance, **R**:

$$E = I(R + r)$$

where **r** is the internal resistance of the battery.

The term "electromotive force" strictly applies to a source of electrical energy but is sometimes misused as being equivalent to potential difference. Symbol **E**. Abbreviated as EMF.

ELONGATION - The state of being elongated or lengthened.

EMC - Abbreviation for electromagnetic compatibility. No emission of interference exceeding FCC limits.

EMF - Abbreviation for electromotive force. See electromotive force.

EMI - Abbreviation for electromagnetic interference.

EMP - Abbreviation for electromagnetic pulse.

ENAMELED WIRE - A conductor with a baked-on varnish enamel; may be 7 AWG through 50 AWG. Intended for use in winding motors, coils, transformers, and other applications of similar usage.

ENERGIZE - To apply rated voltage to a circuit or device, such as the coil of a relay, in order to activate it.

ENERGY - The capacity for performing work.

EP - Abbreviation for ethylene propylene.

EPDM - Abbreviation for ethylene propylenediene monomer rubber.

EPN - Abbreviation for extended performance network cable.

EPOXY - A potting resin used in bonding, e.g., to bond Teflon® wire to pot connectors to assure that they are moisture proof. Teflon® is a trademark of the DuPont de Nemours Co.

EPR - Abbreviation for ethylene propylene copolymer rubber. It has properties similar to butyl rubber. The polymer is chemically cross-linked.

ESI - Abbreviation for electrostatic interference.

ETCHED WIRE - A process applied to Teflon® wire in which the wire is passed through a sodium bath to create a rough surface to allow epoxy resin to bond the Teflon®. Teflon® is a trademark of the DuPont de Nemours Co.

ETFE - Abbreviation for ethylene tetrafluoroethylene. Trade name is Tefzel®. See ethylene tetrafluoroethylene. Tefzel® is a trademark of the DuPont de Nemours Co.

ETHERNET - Local area network configuration.

ETHYLENE - A colorless flammable gaseous unsaturated hydrocarbon C₂H₄ that is found in coal gas. It can be produced by pyrolysis of petroleum hydrocarbon.

California

1959 East Cashdan Street, Rancho Dominguez, CA 90220
(310) 609-1811 • (800) 326-0006 • FAX: (310) 609-1862
E-Mail: salesrd@std-wire.com

Arizona

3120 West Thomas Road, Bldg. #801, Phoenix, AZ 85017
(602) 269-2501 • (800) 325-6478 • FAX: (602) 278-7134
E-Mail: salesphx@std-wire.com



Standard Wire & Cable Co.

ETHYLENE CHLOROTRIFLUOROETHYLENE - A high temperature fluoropolymer of high dielectric strength (HALAR®). Abbreviation ECTFE. Also abbreviated as ECTFE-XI. Halar® is a trademark of the Allied Chemical Co.

ETHYLENE TETRAFLUOROETHYLENE - A high temperature insulation of high dielectric strength, Tefzel®. Abbreviation ETFE. Tefzel® is a trademark of the DuPont de Nemours Co.

ETHYLENE TETRAFLUOROETHYLENE COPOLYMER - A high temperature cross-linked fluoropolymer of high dielectric strength per MIL-C-17. Abbreviation XLETFE.

ETL - ETL Testing Laboratory.

EXTREMELY HIGH FREQUENCY - See frequency band.

EXTRUDE - To shape (as metal or plastic) by forcing through a die.

EXTRUSION - The process of continuously forcing both a plastic or elastomer and a conductor core through a die, thereby applying a continuous coating of insulation or jacket to the core or conductor.

F

f - Abbreviation for farad. See farad.

F - Abbreviation for Fahrenheit. See Fahrenheit.

FAA - Abbreviation for Federal Aeronautics Administration.

FAHRENHEIT - A scale for measuring temperature. Water freezes at 32° F and boils at 212° F. Abbreviated F.

FARAD - A unit of capacitance. Usually expressed in microfarads (μF) one-millionth (10^{-6}) of a farad; or picofarads (pF) one-trillionth (10^{-18}) of a farad. Abbreviation f.

FATIGUE RESISTANCE - Resistance to metal crystallization that occurs when the conductors or wires break from flexing.

FAULT CURRENT - A current that may flow through a circuit or device as a result of a fault, such as a defect in the insulation.

FDDI - Abbreviation for fiber distributed data interface.

FEP - Abbreviation for fluorinated ethylene propylene. It was formerly called X-100 or FEP-100. This FEP fluorocarbon resin is in the Teflon® family. Teflon® is a trademark of the DuPont de Nemours Co.

FEP-IX - Abbreviation for extruded fluorinated ethylene propylene, type IX per MIL-C-17.

FEP-XII - Abbreviation for extruded fluorinated ethylene propylene, type XII per MIL-C-17.

FF - There are two types, commercial and military. Commercial type is UL approved fixture wire. Construction is stranded copper conductor, rubber insulation, and cotton braid. Military type FF is MIL-W-16878D, 1,000 volt, 200° C, sizes 24 AWG to 4/0 AWG. Construction is stranded tin copper conductor, silicone rubber insulation, with or without an outer glass braid.

FG - Abbreviation for fiberglass.

FG BRAID-V - Abbreviation for fiberglass impregnated type V per MIL-C-17.

FHPE - Abbreviation for foamed high density polyethylene.

FIBER OPTICS - Transmission of energy by light through glass fibers.

FIELD - Area through which passes electric and/or magnetic lines of force.

FIGURE 8 CABLE - An aerial cable in which the conductors and steel supporting strand are jacketed together in such a manner that a cross section of the cable approximates the figure eight.

FILLED CABLE - A telephone cable construction in which the cable core is filled with a material that will prevent moisture from entering or passing through the cable.

FILLED STRAND - Conductor in which the interstices between the individual wires are filled with a compound to prevent moisture migration along the conductor.

FILLER - a) Fillers are used in multi-conductor cable to occupy the voids formed by the assembled conductors. This is done so that the resulting configuration will be round. b) An inert substance added to a compound to improve properties or decrease cost.

FIRE CONTROL EQUIPMENT - This is equipment that automatically directs the firing of armament. It is constructed in accordance with International Municipal Signal Association Standards. These standards recognize 18 to 9 AWG wires and cables that may be insulated with rubber or polyethylene with lead or lead alloy sheath.

FL - Abbreviation for FL poly tape.

FLAME-RESISTANCE - The ability of a material not to propagate flame once the heat source is removed.

FLAME-RETARDANT - Ability of a material to prevent the spread of combustion by a low rate of travel so the flame will not be conveyed.

FLAMMABILITY - The measure of a material's ability to support combustion.

FLASHOVER - A disruptive discharge in the form of an arc or spark between two electrical conductors or between a conductor and earth.

California

1959 East Cashdan Street, Rancho Dominguez, CA 90220
(310) 609-1811 • (800) 326-0006 • FAX: (310) 609-1862
E-Mail: salesrd@std-wire.com

Arizona

3120 West Thomas Road, Bldg. #801, Phoenix, AZ 85017
(602) 269-2501 • (800) 325-6478 • FAX: (602) 278-7134
E-Mail: salesphx@std-wire.com



Standard Wire & Cable Co.

FLASHOVER VOLTAGE - The voltage between two conductors at which flashover just occurs. The dry flashover voltage is the voltage at which flashover occurs when the conductors are separated by a clean dry insulator. The wet flashover voltage is the voltage at which flashover occurs when the clean insulator is wet.

FLAT CONDUCTOR - A wire having a rectangular cross section as opposed to round or square conductors.

FLEX. - Abbreviation for flexible.

FLEX LIFE - The measure of the ability of a conductor or cable to withstand repeated bending.

FLEXOPRENE® - Standard Wire & Cable Co. trademark for Neoprene® jacketed portable cord and cable. Neoprene® is a trademark of the DuPont de Nemours Co.

FLUOROCARBON - Any of various chemically inert compounds containing carbon and fluorine used chiefly as lubricants, refrigerants, nonstick coatings, and formerly aerosol propellants and in making resins and plastics.

FLUOROPOLYMER - Insulations or jackets characterized by the presence of fluorine in the formulation.

FM - Abbreviation for frequency modulation.

FOAMED PLASTICS - Insulations having a cellular structure.

FP - Abbreviation for fluorocarbon polymer, modified polytetrafluoroethylene (PTFE). See polytetrafluoroethylene.

FPL - Abbreviation for fire protective power-limited signaling circuit cable.

FPLP - Abbreviation for fire protective power-limited signaling circuit plenum cable.

FPLR - Abbreviation for fire protective power-limited signaling circuit riser cable.

FR-1 - See VW-1.

FREQUENCY - The number of times an alternating current reverses itself in one second. Expressed in Hertz (Hz), which is one cycle per second.

FREQUENCY BAND - A particular range of frequencies that forms part of a larger continuous series of frequencies. The internationally agreed radio frequency bands are shown below:

Wavelength	Band	Frequency
1 mm - 1 cm	extremely high frequency (EHF)	300 - 30 GHz

1 cm - 10 cm	superhigh frequency (SHF)	30 - 3 GHz
10 cm - 1 m	ultrahigh frequency (UHF)	3 - 0.3 GHz
1 m - 10 m	very high frequency (VHF)	300 - 30 MHz
10 m - 100 m	high frequency (HF)	30 - 3 MHz
100 m - 1,000 m	medium frequency (MF)	3 - 0.3 MHz
1 Km - 10 Km	low frequency (LF)	300 - 30 KHz
10 Km - 100 Km	very low frequency (VLF)	30 - 3 KHz

Microwave frequencies, ranging from VHF to EHF bands are usually subdivided into bands designated by letters. These are not internationally agreed upon but the commonly used subdivisions are shown below:

Band	Frequency (GHz)	Wavelength (cm)
P	0.225 - 0.390	133.3 - 76.9
L	0.390 - 1.550	76.9 - 19.3
S	1.550 - 5.20	19.3 - 5.77
X	5.20 - 10.90	5.77 - 2.75
K	10.90 - 36.00	2.75 - 0.834
Q	36.0 - 46.0	0.834 - 0.652
V	46.0 - 56.0	0.652 - 0.536
W	56.0 - 100.0	0.536 - 0.300

FREQUENCY MULTIPLEXING - The technique of sharing a transmission channel wherein carrier signals of different frequencies are transmitted simultaneously.

FRHF - Abbreviation for flame-retardant and halogen-free. A sheathing material which is flame-retardant, halogen-free, noncorrosive, low-smoke, and nonfire propagating.

F/S - Abbreviation for foam skin insulation (expanded polyolefin with a skin of solid polyolefin).

ft - Abbreviation for feet.

FT-4 - CSA designation for vertical tray flame test.

California

1959 East Cashdan Street, Rancho Dominguez, CA 90220
(310) 609-1811 • (800) 326-0006 • FAX: (310) 609-1862
E-Mail: salesrd@std-wire.com

Arizona

3120 West Thomas Road, Bldg. #801, Phoenix, AZ 85017
(602) 269-2501 • (800) 325-6478 • FAX: (602) 278-7134
E-Mail: salesphx@std-wire.com



FT-6 - CSA designation for plenum or MI flame test.

FUSED SPIRAL TAPE - This refers to a type of Teflon® insulated hook-up wire. The conductor is run through a taping head so that each successive wrap overlays the previous wrap. The spiral wrapped conductor is then passed through a sintering oven where the overlaps are fused together. The wire is then sized and polished. Teflon® is a trademark of the DuPont de Nemours Co.

FUSION SPLICE - A splice accomplished by the application of localized heat sufficient to fuse or melt the ends of two lengths of optical fiber. Same as heat shrink splice.

G

g - Abbreviation for gram.

G - Symbol for conductance. See conductance.

G. CABLE - G. cable is a type W or power cable with ground wires. The total CM (circular mil) area of the ground wires is approximately one-half to three-quarters of the CM area of one of the conductors.

GAS FILLED CABLE - Paper insulated lead sheath cable filled with gas which provides a self-supervised alarm system. There are three different types; low pressure, medium pressure, and high pressure. They may be installed in ducts, in air, or buried directly.

GAS PRESSURE COMPENSATED - A saturated paper insulated cable containing tubes for the transmission of gas pressure along a cable and with external gas feed to the tubes.

GAUGE - A term used to denote the physical size of a wire.

GC - Abbreviation for ground conductor.

GFI - Abbreviation for Ground Fault Interrupter. A protective device that detects abnormal current flowing to ground and then interrupts the circuit.

G-GC - Type G-GC mining cable with grounding conductor and a ground check conductor.

GHz - Abbreviation for gigahertz. See gigahertz.

GIGA - A prefix to a unit, denoting a multiple of one billion (10^9) of that unit.

GIGAHERTZ - A term for one billion (10^9) cycles per second. Used to replace the more cumbersome term kilomegacycle. Abbreviation GHz.

GLASS BRAID - Used to provide thermal and/or mechanical protection to the underlying insulation of certain types of conductors.

GPU - Abbreviation for Ground Power Unit. A GPU is a mobile power generator used typically at airports.

GRADED INDEX - In fiber optic cable the refractive index profile that varies with the radius of the core. The refractive indices decrease from the center axis out. The purpose is to reduce modal dispersion and thereby increase fiber bandwidth.

GROMMET - A flexible loop that serves as a fastening, support, or reinforcement; an eyelet of firm material to strengthen or protect an opening or to insulate or protect something passed through it.

GROUND - An object that makes an electrical connection with the earth; a large conducting body (as the earth) used as a common return for an electrical circuit and as an arbitrary zero potential; synonym for earth.

GROUND FAULT - A failure of transmission involving insulation to shield or insulation to ground wire.

GROUND POWER CABLE - A cable assembly fitted with the applicable terminations to supply power to an aircraft from a ground power unit (GPU).

GROUND NEUTRAL - The neutral wire is metallicity connected to ground.

GRS - Abbreviation for Government Rubber Synthetic. This is a government standard for Buna-S rubber for jacketing and insulating compounds for military wires and cables.

GS - Abbreviation for galvanized steel.

GTO - Abbreviation for gas tube, sign, and oil burner ignition cable. Stranded tin copper conductor, polyethylene insulation, PVC jacket overall. Manufactured in 14 AWG for 10 kV and 15 kV service.

gu - Abbreviation for gauge.

GW - Abbreviation for galvanized wire.

H

H - Abbreviation for henry (unit of measure of inductance).

H-FILM® - High temperature polyimide Kapton® film. H-FILM® and Kapton® are trademarks of the DuPont de Nemours Co.

HALAR® - Ethylene chlorotrifluoroethylene or ECTFE copolymer. A high temperature insulation. Halar® is a trademark of the Allied Chemical Co. See ethylene chlorotrifluoroethylene.

HALOGEN - Any of the five elements fluorine, chlorine, bromine, iodine, and astatine that form part of group VII A of the periodic table and exist in the free state normally as diatomic molecules.

California

1959 East Cashdan Street, Rancho Dominguez, CA 90220
(310) 609-1811 • (800) 326-0006 • FAX: (310) 609-1862
E-Mail: salesrd@std-wire.com

Arizona

3120 West Thomas Road, Bldg. #801, Phoenix, AZ 85017
(602) 269-2501 • (800) 325-6478 • FAX: (602) 278-7134
E-Mail: salesphx@std-wire.com



Standard Wire & Cable Co.

HAM - An amateur radio operator.

HARD DRAWN - The conductor is work hardened in the drawing process. Hard drawn refers to the temper of conductors that are not annealed after drawing.

HARNESS - An arrangement of wires and cables, usually with many breakouts, which have been tied together or pulled into a rubber or plastic sheath, used to interconnect an electric circuit.

HASH MARK STRIPE - A noncontinuous helical stripe applied to a conductor for identification.

HD - Abbreviation for high density.

HDP - Abbreviation for high density polyethylene. Compared to PE (polyethylene) it has higher abrasion resistance, higher weatherability, and lower flexibility at room and low temperature. Also abbreviated as HDPE.

HDPE - Abbreviation for high density polyethylene. Compared to PE (polyethylene) it has higher abrasion resistance, higher weatherability, and lower flexibility at room and low temperature. Also abbreviated as HDP.

HDXLPE - Abbreviation for high density cross-linked polyethylene.

HEAD SET CORD - A very flexible cord used for communication equipment usually 24 AWG to 22 AWG multi-conductor. Usually made with Buna insulation, rubber or Neoprene® jacket; sometimes the outer jacket is a cotton braid. The conductor may be bare copper or cadmium bronze. Neoprene® is a trademark of the DuPont de Nemours Co.

HEAT AND PRESSURE CURE - Uncured rubber or rubberlike compound that is usually cooked in a mold under high pressure at a given temperature. The pressure, temperature, and time required for curing depends upon the type of compound used.

HEAT ENDURANCE - The time of heat aging that a material can withstand before failing a specific physical test.

HEAT SEAL - A method for sealing a tape-wrap jacket by thermal fusion.

HEAT SHOCK - A test to determine stability of a material by sudden exposure to a high temperature for a short period of time.

HEAT SHRINK - A material that shrinks when heated. Heat shrink tubing is used for insulation, sealing, and protecting wire connections, terminations, and splices.

HEAT SHRINK SPLICE - Same as Fusion Splice except the splice is protected within a heat shrink tube.

HEATER CORD - Flexible stranded copper conductor, cotton wrapped, rubber insulation, and high temperature roving. For indoor use on household appliances such as flat irons, coffee pots, toasters, heaters, and soldering irons.

HECTO - A prefix to a unit, denoting a multiple of 100 (10²) of that unit.

HELICAL STRIPE - A continuous spiral stripe applied to the insulation of a conductor for the purpose of circuit identification.

HELIX - Something spiral in form; a coil formed by winding wire around a uniform tube; a curve traced on a cylinder or cone by the rotation of a point crossing its right sections at a constant oblique angle.

HENRY - The unit of measure of inductance. It is defined as the inductance of a circuit in which a counter electromotive force of one volt is generated when the current is changing at the rate of one ampere per second. Abbreviation H.

HERTZ - A term replacing cycles per second as an indication of frequency. Abbreviation Hz.

HF - a) Heavy Formvar Magnet Wire. Soft bare copper wire with baked synthetic insulation overall. b) Abbreviation for high frequency. See frequency band.

HF/LS/LT - Abbreviation for halogen-free, low smoke, low toxicity.

HI-POT (HIGH POT) - A test designed to determine the highest potential that can be applied to a conductor without breaking through the insulation.

HIGH FREQUENCY - See frequency band.

HIGH TENSION - See high voltage. Abbreviation HT.

HIGH VOLTAGE - A wire or cable with an operating voltage over 600 volts.

HL - CSA mark used to identify cables which comply with the Hazardous Location performance requirements of CSA C22.2 No. 174 specification.

HMWPE - Abbreviation for high molecular weight polyethylene.

HOOK-UP WIRE - A wire used for low current, low voltage (under 1,000 volts) applications within enclosed electronic equipment, usually 12 AWG and smaller.

HOT TIN DIP - A process of passing bare wire through a bath of molten tin to provide a coating.

HPD - Heater cord, rubber, and high temperature barrier, insulated with an overall braid.

HPN - Heater cord, Neoprene®, parallel, two conductor. Neoprene® is a trademark of the DuPont de Nemours Co.

HR - Abbreviation for high resistance wire.

hrs - Abbreviation for hours.

California

1959 East Cashdan Street, Rancho Dominguez, CA 90220
(310) 609-1811 • (800) 326-0006 • FAX: (310) 609-1862
E-Mail: salesrd@std-wire.com

Arizona

3120 West Thomas Road, Bldg. #801, Phoenix, AZ 85017
(602) 269-2501 • (800) 325-6478 • FAX: (602) 278-7134
E-Mail: salesphx@std-wire.com



Standard Wire & Cable Co.

HT - a) Abbreviation for high tension. See high voltage. b) Abbreviation for high temperature.

HW - Type designation for heavy wall, 2,500 volt electronic hook-up wire to MIL-W-76.

HYGROSCOPIC - Readily absorbing and retaining moisture.

HYPALON® - A synthetic rubber, chlorosulfonated polyethylene (CSPE or CP). Hypalon® is a trademark of the DuPont de Nemours Co. Resistant to oxidation by ozone, sun, weather, heat, and chemicals, rated 90° C.

Hz - Abbreviation for Hertz. See Hertz.

I

I - Symbol used to designate current. See current.

IACS - Abbreviation for International Annealed Copper Standard. Refined copper for electrical conductors: 100% conductivity at 20° C for 1 m X 1 mm² has 1/58 ohm resistivity, 8.93 (changed to 8.89 in 1977) grams per mm² density, 0.000017 per degree C coefficient of linear expansion, and 1/254.45 per degree C coefficient of variation of resistance.

IC - Abbreviation for integrated circuit.

ICEA - Abbreviation for Insulated Cable Engineers Association, formerly IPCEA.

ID - Abbreviation for identification.

I.D. - Abbreviation for inside diameter.

IEC - Abbreviation for International Electrotechnical Commission, similar to the International Standards Organization (ISO).

IEEE - Abbreviation for Institute of Electrical and Electronic Engineers. Formerly American Institute of Electrical Engineers (AIEE) and Institute of Radio Engineers (IRE).

IMP - Abbreviation for impedance. See impedance.

IMPACT STRENGTH - A test for determining the mechanical punishment a cable can withstand without physical or electrical breakdown by impacting with a given weight, dropped a given distance, in a controlled environment.

IMPEDANCE - A measure of the response of an electric circuit to an alternating current. Measured in ohms (volts per ampere). Symbol **Z**. The current is opposed by the capacitance and inductance of the circuit in addition to the resistance. The total opposition to current flow is the impedance, given by the formula:

$$Z = R + iX$$

where **R** is resistance, **X** is reactance and **i** equals $\sqrt{-1}$.

The real part, the resistance, represents a loss of power due to dissipation. The imaginary part, the reactance, indicates the phase difference between the voltage and current. It is either positive or negative depending on whether the current lags or leads the voltage, respectively. In a circuit containing only resistance or in a resonant circuit, the current and voltage are in phase and **Z** is purely resistive. In a circuit containing only reactance, the current and voltage are out of phase and **Z** is purely imaginary, i.e., there is no dissipation in the circuit. Reciprocal of admittance. Abbreviated imp.

IMPEDANCE, HIGH - Generally, the area of 25,000 ohms or higher.

IMPEDANCE, LOW - Generally, the area of 1 through 600 ohms.

IMPREGNATED CABLE - A cable with paper insulation in which the insulating properties of the paper tapes are improved by impregnating them with an insulating compound, such as oil.

IMPULSE STRENGTH - The voltage breakdown of insulation under voltage surges on the order of microseconds in duration.

IMSA - Abbreviation for International Municipal Signal Association, specification for fire alarm cable.

in - Abbreviation for inches.

INCL - Abbreviation for including.

INDEX OF REFRACTION - See refractive index.

INDIV - Abbreviation for individual.

INDUCED CURRENT - An electric current that flows in a conductor as a result of a changing magnetic flux density, in which lines of magnetic flux intersect with the conductor.

INDUCTANCE - The property of a circuit or circuit element that opposes a change in current flow, thus causing current changes to lag behind voltage changes. It is measured in henrys. Symbol **L**.

INDUCTION - The phenomenon of a voltage, magnetic field, or electrostatic charge being produced in an object by lines of force from the source of such fields.

INDUCTIVE COUPLING - Cross talk resulting from the electromagnetic field of one conductor on another.

INSERTION LOSS - The total optical power loss caused by the insertion of an optical component such as a connector, splice, or coupler.

INSULATION - That portion which is relied upon in a cable to segregate and protect the conductor from the other conductors, conducting parts, or from ground.

California

1959 East Cashdan Street, Rancho Dominguez, CA 90220
(310) 609-1811 • (800) 326-0006 • FAX: (310) 609-1862
E-Mail: salesrd@std-wire.com

Arizona

3120 West Thomas Road, Bldg. #801, Phoenix, AZ 85017
(602) 269-2501 • (800) 325-6478 • FAX: (602) 278-7134
E-Mail: salesphx@std-wire.com



Standard Wire & Cable Co.

INSULATION LEVEL - The impulse voltage breakdown of cables and equipment.

INSULATION RESISTANCE - The resistance offered by an insulating material to the flow of current resulting from an impressed DC voltage.

INSULATOR - a) A nonconducting substance such as porcelain, plastic, glass, rubber, etc; b) a device made of such material used for separating or supporting conductors to prevent undesired flow of electricity.

INTERAXIAL SPACING - Center to center conductor spacing in paired wire; center to center spacing between conductors in a flat cable.

INTERCOM WIRE - Wire used to connect communication instruments, telephones, telegraphs, etc.

INTERLACED TAPES - Two or more tapes, generally of different composition, applied simultaneously in such a manner that a portion of each tape overlaps a portion of the other tape.

INTERSTICE - A space that intervenes between things.

IPCEA - Abbreviation for Insulated Power Cable Engineers Association. Now ICEA.

IPE - Abbreviation for irradiated polyethylene tape.

IRE - Abbreviation for Institute of Radio Engineers, now IEEE.

IRON CONSTANTAN - A combination of metals used in thermocouple, thermocouple wires, and thermocouple lead wires. The iron wire is positive. The constantan is the negative wire.

IRRADIATION - In insulations, the exposure of the material to high energy emissions for the purpose of favorably altering the molecular structure by cross-linking.

ISA - Abbreviation for Instrument Society of America.

ISO - Abbreviation for International Standards Organization.

ISO 9000 - An international quality assurance program.

J

J-BOX - Abbreviation for junction box. A box for joining different runs of raceway or cable, plus space for connecting and branching the enclosed conductors.

JACKET - A covering over insulation usually nonmetallic, plastic, rubber, cotton, Neoprene®, fluoropolymer, or glass. Neoprene® is a trademark of the DuPont de Nemours Co.

JAN-C-17A - Joint Army-Navy specifications covering coaxial cables used for high frequency applications in radio, television, radar, etc.

JAN-C-76A - Joint Army-Navy specifications covering radio hook-up wire. Types SRIR, SRHV, WL, and SRRF. Superseded by MIL-W-76.

JOULE - The unit of measure for energy or work. The international joule is equal to the work required to maintain a current of one ampere for one second in a resistance of one ohm.

JUMPER - Usually a temporary connection. A short length of conductor to connect between terminals, across a break in a circuit, or around an instrument.

JUTE FILLER - Rope like strands of material used in cables for filling in the voids to form a rounded final cable shape.

K

K - Abbreviation for Karma®. Karma® is a trademark of the Driver Harris Company.

K BAND - A band of microwave frequencies. See frequency band.

KAPTON® - Trade name for polyimide resin. See polyimide. Kapton® is a trademark of the DuPont de Nemours Co.

KARMA® - Trade name of the Driver Harris Company for a resistance wire composed of 74.5% nickel, 20% chromium, 2.75% aluminum, and 2.75% copper. Abbreviated K.

KEVLAR® - Trademark of the DuPont de Nemours Co. for the para-aramid fiber polyparaphenylene terephthalamide. See polyparaphenylene terephthalamide.

kgs - Abbreviation for kilograms.

kHz - Abbreviation for kilohertz. See kilohertz.

KILO - A prefix to a unit, denoting a multiple of one thousand (1,000) of that unit; a prefix used in computing to denote a multiple of one thousand, twenty four (2¹⁰).

KILOHERTZ - One thousand (1,000) cycles per second. Abbreviation kHz.

KILOVOLT - One thousand (1,000) volts. Abbreviation kV.

KILOVOLT AMPERE - One thousand (1,000) volts x amperes. Abbreviation kVA

KILOWATT - A unit of measure of power equal to one thousand (1,000) watts. Abbreviation kW.

California

1959 East Cashdan Street, Rancho Dominguez, CA 90220
(310) 609-1811 • (800) 326-0006 • FAX: (310) 609-1862
E-Mail: salesrd@std-wire.com

Arizona

3120 West Thomas Road, Bldg. #801, Phoenix, AZ 85017
(602) 269-2501 • (800) 325-6478 • FAX: (602) 278-7134
E-Mail: salesphx@std-wire.com



Standard Wire & Cable Co.

KIRCHOFF'S LAWS - The algebraic sum of the currents at any point in a circuit is zero; the algebraic sum of the product of the current and the impedance in each conductor in a circuit is equal to the electromotive force in the circuit.

km - Abbreviation for kilometer (1,000 meters).

KOVAR - An alloy of iron, nickel, and cobalt.

kV - Abbreviation for kilovolt (1,000 volts). See kilovolt.

kVA - Abbreviation for kilovolt ampere (1,000 volt ampere). See kilovolt ampere.

kW - Abbreviation for kilowatt (1,000 watts). See kilowatt

KYNAR® - Trademark of the Pennwalt Corporation for polyvinylidene fluoride. See polyvinylidene fluoride.

L

L - Symbol for inductance. See inductance.

L BAND - A band of microwave frequencies. See frequency band.

LACQUER FINISH - A finish applied over braided wire or cable for appearance, for moisture proofing, to reduce friction, and resist abrasion.

LAMINATES - A buildup of layers of material to increase thickness as in braid varnished cambric (VCB).

LAMP CORD - Flexible stranded conductor cord, rubber or plastic insulated, used in wiring of lamps, household fans, and similar appliances. Not subject to hard usage. UL approved.

LAN - Abbreviation for Local Area Network. See local area network.

LAPEL MIKE CABLE - Small O.D., flexible microphone cable.

LASER - Acronym from **l**ight **a**mplification by **s**timulated **e**mission of **r**adiation. A source of intense monochromatic coherent radiation in the visible, ultraviolet, or infrared regions of the electromagnetic spectrum. The narrow beam can be either pulsed or continuous.

LATEX - Rubber material used for insulation of wire.

LAUNCH FIBER - An optical fiber used to couple and condition light from an optical source into an optical fiber. Often the launch fiber is used to create an equilibrium modal distribution in multi-mode fiber. Also referred to as launching fiber.

LAY - The length measured along the axis of a wire or cable required for a single strand (in stranded wire) or conductor (in cable) to make one complete turn around the axis of the conductor or cable.

lbs - Abbreviation for pounds.

LDPE - Abbreviation for low density polyethylene.

LEACHING AND NONLEACHING - In a leaching wire, the plasticizer will migrate or leave the vinyl compound when exposed to the heat of baking. The wire so treated becomes brittle and hard. A nonleaching wire will retain its plasticizer under extreme temperature conditions and remain flexible after baking. Nonleaching wire is desirable for use as motor lead wire.

LEAD CURED - A cable that is cured or vulcanized in a metallic lead mold.

LEAD-IN - The cable that connects the active part of an aerial to the transmitter or receiver.

LEAKAGE - The passage of an electric current along a path other than that intended due to faulty insulation or isolation in a circuit, component, device, or other piece of apparatus.

LED - Abbreviation for light emitting diode.

LEVEL 1, 2, 3, 4, & 5 - Underwriters Laboratories' performance designations for unshielded, twisted pair cables. See Category 1, 2, 3, 4, or 5.

LF - Abbreviation for low frequency. See frequency band.

LINE VOLTAGE - The voltage existing in a cable or circuit.

LITZ WIRE - Short for litzendraht wire. A construction of fine individually insulated strands specially woven or braided together to reduce skin effect and thus lower resistance to high frequency currents.

LOCAL AREA NETWORK - A baseband or broadband interactive bidirectional communication system for voice, video, or data use on a common cable medium. Abbreviation LAN.

LONGITUDINAL SHIELD - A tape shield, flat or corrugated, applied longitudinally with the axis of the core being shielded.

LOOP RESISTANCE - The total resistance of two conductors measured round-trip from one end.

LOOSE TUBE (BUFFER) - A type of cable construction in which the fiber is placed in a plastic tube with a diameter much larger than the fiber itself. The loose tube isolates the fiber from exterior mechanical forces acting on the cable. The space between the tube and fiber is often filled with a gel which serves to cushion the fiber.

LOSS FACTOR - The product of the dissipation and dielectric constant of an insulating material.

LOW FREQUENCY - See frequency band.

LOW LOSS - A cable that has a small amount of power loss when extended over long lengths.

California

1959 East Cashdan Street, Rancho Dominguez, CA 90220
(310) 609-1811 • (800) 326-0006 • FAX: (310) 609-1862
E-Mail: salesrd@std-wire.com

Arizona

3120 West Thomas Road, Bldg. #801, Phoenix, AZ 85017
(602) 269-2501 • (800) 325-6478 • FAX: (602) 278-7134
E-Mail: salesphx@std-wire.com



Standard Wire & Cable Co.

LOW NOISE - A cable constructed in such a manner as to reduce to a minimum any signals generated by the motion of the cable components in respect to each other. Used to reduce the noise level in coaxial or microphone cable circuits.

LOW TENSION - Low voltage as applied to ignition cable.

LT - Abbreviation for low temperature noncontaminating jacket, Type II.

LW - Abbreviation for light wall, 300 volt, electronic hook-up wires to MIL-W-76.

M

m - Abbreviation for meter. See meter.

M - Abbreviation for Mylar®. See Mylar®. Mylar® is a trademark of the DuPont de Nemours Co. Also abbreviated as MY.

mA - Abbreviation for milliampere, one-thousandth (10^{-3}) of an ampere.

MAG. OX. - Abbreviation for magnesium oxide.

MAGNET WIRE - Insulated copper wire used for winding coils, motors, and transformers.

MAINS - The source of domestic electrical power distributed nationally throughout the U.K. The mains frequency is the frequency at which the electrical power is supplied. This is 50 hertz in the U.K. and 60 hertz in the U.S.

MARKER TAPE - A tape laid parallel to the conductors under the sheath in a cable, imprinted with the manufacturer's name and the specification to which the cable is made.

MARKER THREAD - A colored thread laid parallel and adjacent to the strand in an insulated conductor which identifies the manufacturer and sometimes the specification to which the wire is made.

MAT - Abbreviation for material.

MATV - Abbreviation for Master Antenna TV.

MAX - Abbreviation for maximum.

Mbps - Abbreviation for megabits per second.

MC - Abbreviation for megacycle.

MCM - Abbreviation for one thousand (1,000) circular mils, e.g., 500 MCM = 500,000 circular mils.

MECHANICAL SPLICE - A fiber splice accomplished by fixtures or materials, rather than by thermal fusion. Index matching material may be applied between the two fiber ends.

MEDIUM FREQUENCY - See frequency band.

MEGA - A prefix to a unit, denoting a multiple of one million (1,000,000) of that unit.

MEGAHERTZ - One million (1,000,000) cycles per second. Abbreviation MHz.

MEGAWATT - One million (1,000,000) watts. Abbreviation MW.

MELAMINE - A thermosetting resin chemically known as melamine formaldehyde. It has excellent resistance to acids and alkalis and good resistance to water and solvents. Has high strength, high insulation resistance as compared to plastics.

MESA - Abbreviation for Mining Enforcement and Safety Administration. Formerly PBM (Pennsylvania Bureau of Mines).

MESSENGER - The linear supporting member, usually a high strength steel wire, used as the supporting element of a suspended aerial cable. The messenger may be an integral part of the cable or exterior to it.

METER - The unit of length defined as the length of the path traveled by light in vacuum during a time interval of $1/299,792,458$ of a second. One meter equals 39.3701 inches. Abbreviation m.

MF - Abbreviation for medium frequency. See frequency band.

Mfd - Abbreviation for microfarad. See microfarad.

MFG. - Abbreviation for manufacture/manufacturing.

MFT - Abbreviation for one thousand (1,000) feet.

MHD - Abbreviation for medium hard drawn copper wire.

Mho - The unit of conductivity. The reciprocal of an ohm.

MHz - Abbreviation for megahertz, one million (1,000,000) cycles per second. Formerly mc. See megahertz.

MI - Nomenclature for mineral insulated cable, made with one or more conductors using mineral for insulation and overall solid metal tube sheath.

MICA - A transparent silicate which separates into layers and has high insulation resistance, high dielectric strength, and high heat resistance.

MICRO - A prefix to a unit, denoting a submultiple of one-millionth (10^{-6}) of that unit.

MICROBENDING - Minute but sever bends in the fiber of fiber optic cable that result in light displacement and increased loss. Most microbending can be avoided by the correct selection of materials and proper cabling, handling, and installation techniques.

California

1959 East Cashdan Street, Rancho Dominguez, CA 90220
(310) 609-1811 • (800) 326-0006 • FAX: (310) 609-1862
E-Mail: salesrd@std-wire.com

Arizona

3120 West Thomas Road, Bldg. #801, Phoenix, AZ 85017
(602) 269-2501 • (800) 325-6478 • FAX: (602) 278-7134
E-Mail: salesphx@std-wire.com



Standard Wire & Cable Co.

MICROFARAD - A unit of measure for capacitance. One-millionth (10^{-6}) of a farad. Abbreviation μF or Mfd.

MICROMETER - A unit of length equal to one-millionth (10^{-6}) of a meter, formerly called micron. Abbreviated μm .

MICROMINIM[®] - Ultra-flexible micro-miniature wire. A trade name of Standard Wire & Cable Co.

MICRON - A unit of length equal to one-millionth (10^{-6}) of a meter, now renamed as the micrometer. Abbreviated μm .

MICROSECOND - One-millionth (10^{-6}) of a second.

MICROWAVE - An electromagnetic wave with a wavelength in the range 3 millimeters to 1-3 meters, i.e., between infrared radiation and radio waves on the frequency spectrum. See frequency band.

MICROWAVE FREQUENCY - See frequency band.

MIGRATION - The movement of the nonresinous plasticizers in vinyl which takes place at elevated or lowered temperatures. The migrating plasticizer from the jacket will contaminate the polyethylene core of a coaxial cable and thus change its electrical characteristics.

MIKE CABLE or MICROPHONE CABLE - A flexible, generally shielded cable used to connect the microphone to the amplifier.

MIL - a) Abbreviation for one-thousandth (10^{-3}) of an inch (0.001"). b) A unit used in measuring the diameter of wire or thickness of insulation. c) Abbreviation for military specification (mil spec).

MIL-C - Military cable specification.

MILLI - A prefix to a unit, denoting a submultiple of one-thousandth (10^{-3}) of that unit.

MILLIMETER - Unit of measure for linear distance. One millimeter equals one-thousandth (10^{-3}) of a meter. Abbreviation mm.

MILLISECOND - One-thousandth (10^{-3}) of a second. Abbreviation ms.

MIL SPEC - Abbreviation for military specification.

MIL STD - Abbreviation for military standard.

MIL-W - Military wire specification.

MIN. - Abbreviation for minimum.

MINIATURE WIRE - Refers to insulated conductors of approximately 20 to 34 AWG with a small overall diameter as compared to usual constructions.

MIP - Abbreviation for mylene irradiated polymer.

mm - Abbreviation for millimeter. See millimeter.

MMfd - Abbreviation for one-trillionth (10^{-12}) of a farad. Commonly referred to as a picofarad (pF).

MODAL DISPERSION - Pulse spreading due to multiple light rays traveling different distances and speeds through a fiber.

MODE - A path of light through a fiber of a fiber optic cable.

MODE FIELD DIAMETER - In single-mode fiber, the region in which light propagates is larger than the glass core diameter. This mode field diameter is a measured value and often listed as a requirement with core diameter in fiber specifications.

MODES - Individual paths in optical waveguides. Single-mode fiber has only one mode, the fundamental mode, while multi-mode fiber has several hundred modes. The upper limit to the number of modes is determined by the core diameter of the waveguide.

MODULUS OF ELASTICITY - The ratio of stress to strain in an elastic material.

MOISTURE RESISTANCE - Ability of a material to resist absorbing moisture from the air or when immersed in water.

MOLDED PLUG - A connector, male or female, molded on either end of a cord or cable.

MONOMER - The basic chemical unit used in building a polymer.

MP - Abbreviation for multipurpose cable.

MPa - Abbreviation for megapascal (10^6 pascals), the metric unit of pressure.

MPG - Abbreviation for multipurpose general purpose cable.

MPP - Abbreviation for multipurpose plenum cable.

MPR - Abbreviation for multipurpose riser cable.

MSHA - Abbreviation for Mining Safety and Health Administration.

MT - Abbreviation for machine tool wire used for internal wiring of appliances or tools. Solid or stranded conductor. Thermoplastic insulations.

MTW - Abbreviation for machine tool wire, plastic insulated, 600 volt, varies 90°C to 105°C .

MULTI-CONDUCTOR - More than one conductor within a single cable complex.

MULTI-MODE FIBER - An optical fiber whose core diameter is large compared with the optical wavelength and thus can contain a large number of modes.

California

1959 East Cashdan Street, Rancho Dominguez, CA 90220
(310) 609-1811 • (800) 326-0006 • FAX: (310) 609-1862
E-Mail: salesrd@std-wire.com

Arizona

3120 West Thomas Road, Bldg. #801, Phoenix, AZ 85017
(602) 269-2501 • (800) 325-6478 • FAX: (602) 278-7134
E-Mail: salesphx@std-wire.com



Standard Wire & Cable Co.

MULTIPLEX - Being or relating to a system of transmitting several messages/signals simultaneously on the same circuit or channel.

MV - Abbreviation for millivolt, one-thousandth (10^{-3}) of a volt.

MW - a) Abbreviation for megawatt, one million (10^6) watts. b) Abbreviation for milliwatt. One-thousandth (10^{-3}) of a watt. c) Usually, used in reference to one thousand (1,000) volt plastic insulated wire covered by MIL-W-76.

MY - Abbreviation for Mylar®. See Mylar®. Mylar® is a trademark of the DuPont de Nemours Co. Also abbreviated as M.

MYLAR® - Trade name for DuPont de Numerous Co. polyester material (polyethylene terephthalate) used in the form of a tape. A synthetic compound with high dielectric properties. Abbreviated as MY and M.

N

N - a) Abbreviation for newtons. See newton. b) Abbreviation for nichrome.

NA - Abbreviation for not applicable.

NA - Abbreviation for numerical aperture. See numerical aperture.

NANO - A prefix to a unit, denoting a submultiple of one-billionth (10^{-9}) of that unit.

NANOMETER - One billionth (10^{-9}) of a meter. Abbreviated nm.

NANOSECOND - One-billionth (10^{-9}) of a second.

NATIONAL ELECTRIC CODE - Recommendations of the National Fire Protection Association (NFPA) are revised every three years. City, county, or state regulations may differ from code regulations and take precedent over NEC Code rules, which of themselves, have no legal status.

NATIONAL FIRE PROTECTION ASSOCIATION -The organization whose prime mission is to maintain and publish the National Electrical Code.

NAVAIR - Abbreviation for Naval Air Systems Command (see NMC).

NAVELEX - Abbreviation for Naval Electronics Systems Command (see NMC).

NAVFAC - Abbreviation for Naval Facilities Engineering Command (see NMC).

NAVORD - Abbreviation for Naval Ordinance Systems Command (see NMC).

NAVSEA - Abbreviation for Naval Sea Systems Command.

NAVSHIPS - Abbreviation for Naval Ships Systems Command (see NMC).

NAVSUP - Abbreviation for Naval Supply Systems Command (see NMC).

NBFU - Abbreviation for National Board of Fire Underwriters.

NBS - Abbreviation for National Bureau of Standards.

NC - a) Abbreviation for nickel-plated copper. Also abbreviated as NPC. b) Abbreviation for nickel-clad copper. Also abbreviated as NCC. c) Abbreviation for nickel conductor.

NCC - Abbreviation for nickel-clad copper. Also abbreviated as NC.

NCCCS - Abbreviation for nickel-covered copper-clad steel.

NEC - Abbreviation for National Electric Code. See National Electric Code.

NEMA - Abbreviation for National Electrical Manufacturers Association. Maintains standardization of electrical motors, gear reducers, and wire and cable specifications.

NEOPRENE® - A synthetic rubber made by the polymerization of chloroprene and characterized by superior resistance (as to oils). Neoprene® is a trademark of the DuPont de Nemours Co.

NET LOSS - The difference between the attenuation and the gain in any circuit, device, network, or transmission line.

NEUTRAL - a) Having no net positive or negative electric charge at earth potential. b) Denoting the line that completes the domestic mains supply and is connected to earth at the power station.

NEWTON - The unit of force in the metric system of physical units that is of such size that under its influence a body whose mass is one kilogram would experience an acceleration of one meter per second per second. Abbreviated N.

NFPA - Abbreviation for National Fire Protection Association. See National Fire Protection Association.

NICKEL-CLAD COPPER WIRE - A wire with a layer of nickel on a copper core where the area of the nickel is approximately 30% of the conductor area. The nickel has been rolled and fused to the copper before drawing. It has a very high resistivity and can operate at extremely high temperatures. Abbreviated NCC and NC.

NICROME® - Driver Harris Company's trade name for an alloy of 60% nickel, 16% chromium, and the balance steel. Used exclusively in wire wound resistors and heating elements.

nm - Abbreviation for nanometer. One-billionth (10^{-9}) of a meter.

California

1959 East Cashdan Street, Rancho Dominguez, CA 90220
(310) 609-1811 • (800) 326-0006 • FAX: (310) 609-1862
E-Mail: salesrd@std-wire.com

Arizona

3120 West Thomas Road, Bldg. #801, Phoenix, AZ 85017
(602) 269-2501 • (800) 325-6478 • FAX: (602) 278-7134
E-Mail: salesphx@std-wire.com



NMC - Abbreviation for Naval Material Command. Central Navy agency for the development, procurement, maintenance, supply, disposal, distribution, and storage of material. Includes the following Systems Commands; the Naval Ships Systems Command (NAVSHIPS), the Naval Ordnance Systems Command (NAVORD), the Naval Air Systems Command (NAVAIR), the Naval Electronics Systems Command (NAVELEX), the Naval Facilities Engineering Command (NAVFAC), and the Naval Supply Systems Command (NAVSUP).

NO. - Abbreviation for number.

NOM. - Abbreviation for nominal.

NOMEX® - DuPont de Nemours Co. trademark for a temperature resistant, flame-retardant nylon.

NONCONTAMINATING - Refers to a type of PVC jacketing material whose plasticizer will not migrate into the dielectric of a coaxial cable and thus avoids contaminating and destroying the dielectric.

NONFERROUS - Not of iron. Refers to alloys which have no iron or steel as ingredients.

NONHYGROSCOPIC - Material does not absorb moisture.

NONMIGRATING - Same as noncontaminating.

NPC - Abbreviation for nickel-plated copper. Also abbreviated as NC.

NPLF - Abbreviation for nonpower-limited fire protective signaling circuit cable.

NPLFP - Abbreviation for nonpower-limited fire protective signaling circuit plenum cable.

NPLFR - Abbreviation for nonpower-limited fire protective signaling circuit riser cable.

NRC - Abbreviation for Nuclear Regulatory Commission.

NUMERICAL APERTURE - In fiber optics, the sine of half the angle over which a fiber can accept light, it is a function of the relationship between the refractive index of the core and that of the cladding. It is the "light gathering ability" of a fiber, defining the maximum angle to the fiber axis at which light will be accepted and propagated through the fiber. Abbreviation NA. NA is also used to describe the angular spread of light from a central axis, as in exiting a fiber, emitting from a source, or entering a detector.

NYLON - A group of polyamide polymers which are used for wire and cable jacketing. Mechanical and chemical protection 105° C.

NYLON JACKETED - Refers to the outer covering of nylon on wire or cable which can either be an extruded layer or a braid of nylon filaments.

O

O.D. - Abbreviation for outside diameter.

OEM - Abbreviation for Original Equipment Manufacturer.

OFC - Abbreviation for optical fiber conductive general purpose cable.

OFFCG - Abbreviation for optical fiber conductive fire resistant general purpose cable.

OFCP - Abbreviation for optical fiber conductive plenum cable.

OFCR - Abbreviation for optical fiber conductive riser cable.

OFFGASSING - Percentage of a specified gas released during the combustion of an insulating or jacketing material.

OFHC - Abbreviation for oxygen free, high conductivity copper. It has no residual deoxidant, 99.95% minimum copper content and an average annealed conductivity of 100%.

OFN - Abbreviation for optical fiber nonconductive general purpose cable.

OFNG - Abbreviation for optical fiber nonconductive fire resistant general purpose cable.

OFNP - Abbreviation for optical fiber nonconductive plenum cable.

OFNR - Abbreviation for optical fiber nonconductive riser cable.

OHM - The unit of measure for electrical resistance, reactance, and impedance. A constant current of one ampere produces a force of one volt. Symbol Ω .

OHM (300) LEAD WIRE - Television lead-in wire. Leads signal in from the antenna to the set.

OHM'S LAW - The electric current, **I**, flowing in a conductor or resistor is linearly proportional to the applied difference, **V**, across it. From the definition of resistance, **R**, Ohm's law can be written:

$$V = IR \text{ (i.e., Volts = Current x Resistance.)}$$

OIL FILLED CABLE - Paper insulated, lead sheathed cable, into which high grade mineral oil is forced under pressure, saturating the insulation. The main object is to prevent moisture and gases from entering. It is also easier to detect flaws due to leakage, as the oil is kept under constant pressure at all times.

OIL FILLED PIPE CABLE - Basically the same as oil filled cable, but inside of rigid pipe instead of lead sheath. Sometimes it is a standard oil filled cable inserted into rigid pipe under

California

1959 East Cashdan Street, Rancho Dominguez, CA 90220
(310) 609-1811 • (800) 326-0006 • FAX: (310) 609-1862
E-Mail: salesrd@std-wire.com

Arizona

3120 West Thomas Road, Bldg. #801, Phoenix, AZ 85017
(602) 269-2501 • (800) 325-6478 • FAX: (602) 278-7134
E-Mail: salesphx@std-wire.com



Standard Wire & Cable Co.

pressure, both units being oil filled. Usually for much higher voltage where constant pressure is maintained at all times.

OIL RESISTANT - Performance characteristics of a material against exposure to a specific oil.

OKOCORD® - Trade name for portable power cables made by Okonite Company.

OKOPRENE® - Trade name for Neoprene® covered wire and cable made by Okonite. Neoprene® is a trademark of the DuPont de Nemours Co.

OPEN WIRE - Synonymous with overhead line. A conductor that is not surrounded by insulation and is supported separately above ground.

OPER. - Abbreviation for operating.

OPTICAL RECEIVER - Unit for converting optical signals into electrical signals.

OPTICAL TIME DOMAIN REFLECTOMETER - An instrument that measures transmission characteristics of fiber by sending a pulse of light down the fiber and measuring the light scattered across the length and reflected back from the end as a function of time. Used to measure attenuation, point discontinuities, and fiber length, as well as to find breaks.

OPTICAL TRANSMITTER - Unit for converting electrical signals into optical signals.

OSHA - Abbreviation for Occupational Safety and Health Act.

OUTGASSING - The dissipation of gas from a dielectric evidencing decomposition.

OVERCOAT - Individual strands of tin copper wire stranded together and then covered with a tin coating.

OVERHEAD LINE - Synonymous with open wire. A conductor that is not surrounded by insulation and is supported separately above ground.

OVERLOAD - Any load delivered at the output of an electrical device, circuit, machine, or other apparatus that exceeds the rated output of the equipment.

OXIDIZE - To change (a compound) by increasing the proportion of the electronegative part or charge (an element or ion) from a lower to a higher positive valence; remove one or more electrons from an atom, ion, or molecule.

OXYGEN BOMB TEST - To determine aging effect, heat, tensile strength, and elongation of wire. The wire is placed in a bomb at 70° C, under 300 psi using pure oxygen gas for a period of 48 to 96 hours.

OXYGEN INDEX - Percentage of oxygen necessary to support combustion of a specified material.

OZ - Abbreviation for ounce.

OZONE - Form of oxygen produced by discharge of electricity into air. Chemical symbol O₂.

P

PAIR - Two insulated wires of a single circuit associated together.

PAIRING - The union of two insulated single conductors through twisting.

PAN CURED - Method of vulcanizing. Coils of unvulcanized insulated wire are coiled in pans and vulcanized under pressure with live steam.

PAP - A commonly used term for air core (unfilled) direct burial telephone cable with a corrugated aluminum shield.

PAPER INSULATED - Insulation used for telephone cable, high voltage cable, and magnet wire. Has high dielectric strength; however, pretty much passe because of better insulations.

PAR - Acronym for **p**recision **a**pproach **r**adar.

PARALLEL CABLE - Two insulated conductors in parallel in a cable.

PATCH CABLE - A power cable with plugs or terminals on each end of the conductor or conductors used to connect equipment.

PATCH CORD - Usually braid covered, with plugs or terminals on each end. Used to connect jacks or blocks in switchboards or analog programming systems. Called a patch cord because it is used to "patch" a circuit.

P BAND - A band of microwave frequencies. See frequency band.

PBM-109 - Trailing mine cable with an outer sheath of flame-resistant Neoprene®. Cable conforms to requirements of Pennsylvania Bureau of Mines and the Federal Bureau of Mines. Neoprene® is a trademark of the DuPont de Nemours Co.

PBX - Abbreviation for private branch exchange.

PC - Abbreviation for Physical Contact adaptor. In fiber optics, the physical contact refers to connectors which provide back reflections (also referred to as return loss) of less than 30 db. D4 adaptors allow the fibers to be butted together, resulting in a constant index of refraction in the optical transmission path, thereby eliminating most of the reflection. In non-PC adaptors, the fiber cores are brought into close proximity to each other with a small air gap (usually only a few microns) between them.

California

1959 East Cashdan Street, Rancho Dominguez, CA 90220
(310) 609-1811 • (800) 326-0006 • FAX: (310) 609-1862
E-Mail: salesrd@std-wire.com

Arizona

3120 West Thomas Road, Bldg. #801, Phoenix, AZ 85017
(602) 269-2501 • (800) 325-6478 • FAX: (602) 278-7134
E-Mail: salesphx@std-wire.com



Standard Wire & Cable Co.

PCP - A commonly used term for air core (unfilled) direct burial cable with a corrugated copper shield.

PCTFE - Abbreviation for polychlorotrifluorethylene. One of the fluoropolymers which has a high dielectric strength used at temperatures to 250° C.

PE - Abbreviation for polyethylene. A thermoplastic insulation having excellent electrical properties. Also abbreviated as poly and pol.

PEAK VOLTAGE - The maximum voltage reached during an alternation of frequency.

PEF - Abbreviation for polyethylene foam. Also abbreviated as PE Foam.

PE FC - Abbreviation for polyethylene flooding compound.

PE Foam - Abbreviation for polyethylene foam. Also abbreviated as PEF.

PE-III - Abbreviation for clear polyethylene.

PE-IIIA - Abbreviation for high molecular weight, black polyethylene, type IIIA, per MIL-C-17.

PERCENT CONDUCTIVITY - Conductivity of a material expressed as a percentage of that of copper.

PERFLUOROALKOXY - High temperature compound in the fluorocarbon family of dielectrics. Used at temperatures to 250° C. Abbreviation Teflon® PFA. Also abbreviated as PFA-XII, per MIL-C-17.

PETROL WIRE - Wire insulated to withstand immersion in gas and oil. Usually thermoplastic with or without a nylon jacket.

pF - Abbreviation for picofarad. See picofarad.

PFA - Abbreviation for perfluoroalkoxy resin. See perfluoroalkoxy.

PFA-XIII - Abbreviation for perfluoroalkoxy resin. See perfluoroalkoxy.

PIB - Abbreviation for polyisobutylene, type B, per MIL-C-17.

PIC - A general term for any type of plastic insulated telephone cable.

PICK - The distance between two adjacent crossover points of braid filaments. The measurement in picks per inch indicates the degree of coverage.

PICO - A prefix to a unit, denoting a submultiple of one-trillionth (10^{-12}) of that unit.

PICOFARAD - A unit of measure for capacitance; one-trillionth (10^{-12}) farads. Abbreviation pF.

PIGTAIL WIRE - Fine stranded, extra flexible, rope lay, lead wire.

PIPE TYPE CABLE - Pressure cable. Pressure medium is a loose rigid metal pipe.

PITCH - In flat cable, the nominal distance between the index edges of two adjacent conductors.

PLAIN ENAMEL - Type of magnet wire. Wire is dip coated with a varnish and then baked.

PLANAR - Of, relating to, or lying in a plane; two-dimensional in quantity.

PLASTICIZER - A chemical agent added to plastics to make them softer and more pliable.

PLATED - Covered with an adherent layer mechanically, chemically, or electrically.

PLENUM - The air return path of a central air handling system, either duct work or open space, over a dropped ceiling.

PLENUM CABLE - Cable approved by Underwriters Laboratories for installation in plenums without the need for conduit. Generally the insulation and jackets are fluorocarbon based materials.

PLSJ - Cord, light duty, all rubber, parallel, two conductor, 300 volt.

PLT - Same as PLSJ except plastic.

PLTC - Abbreviation for parallel tray cable.

P/N - Abbreviation for part number.

PNR - Control cable using polyethylene and nylon on the conductors and PVC jacket.

PO - Rayon parallel lamp cord with a stranded copper conductor, separator, rubber insulation, cotton braid, rayon braid overall. Used in dry places on small appliances.

POL - Abbreviation for polyethylene. Also abbreviated PE and poly. See polyethylene.

POLY - Abbreviation for polyethylene. Also abbreviated PE and pol. See polyethylene.

POLYALKALENE - A polymer, typically polyethylene, made from alkene monomer. Primary insulation compound used in MIL-W-81044.

POLYAMIDE - a) A compound characterized by more than one amide group. b) A polymeric amide (nylon).

POLYCHLOROPRENE - Chemical name for Neoprene®. Used for jacketing wire and cable that will be subject to rough usage, moisture, oil, greases, solvents, and/or chemicals. May also

California

1959 East Cashdan Street, Rancho Dominguez, CA 90220
(310) 609-1811 • (800) 326-0006 • FAX: (310) 609-1862
E-Mail: salesrd@std-wire.com

Arizona

3120 West Thomas Road, Bldg. #801, Phoenix, AZ 85017
(602) 269-2501 • (800) 325-6478 • FAX: (602) 278-7134
E-Mail: salesphx@std-wire.com



Standard Wire & Cable Co.

be used as a low voltage insulating material. Neoprene® is a trademark of the DuPont de Nemours Co.

POLYESTER - Any of a group of polymers that consists basically of repeated units of an ester and are used especially in making fibers or plastics. More specifically, polyethylene terephthalate which is used extensively in the production of a high strength moisture resistant film used as a cable core wrap.

POLYETHYLENE - A thermoplastic material, polymerized ethylene. They are basically pure hydrocarbon resins, often with small amounts of other additives to impart needed properties. All members of the polyethylene family are excellent dielectrics. Electrically they are far superior to any other extrudable dielectric in use today. Outstanding electrical properties include high insulation resistance, high dielectric strength, low dielectric constant, low dielectric loss at all frequencies, excellent resistance to cold flow, and good abrasion resistance. One or more members of the polyethylene family also have the following properties: Resistance to sunlight, weather, chemicals, and flame. Polyethylene is widely used for insulation on telephone, signal and control cables, high frequency electronic cables, high voltage and low voltage power cables, line wire, neutral supported secondary and service drop cables. They are suitable for direct earth burial. Temperature ratings vary with type and application from 75° C up. Abbreviation PE, POL, and POLY.

POLYIMIDE - A relatively high temperature plastic developed for use as a dielectric or jacketing material, Kapton®. Usually laminated to FEP and used as heat sealable tape. It does not burn and has high abrasion resistance. Kapton® is a trademark of the DuPont de Nemours Co.

POLYMER - A material of high molecular weight formed by the chemical union on monomers.

POLYOLEFIN - A family of thermoplastics based upon the unsaturated hydrocarbons known as olefins. When combined with butylene or styrene polymers, they form compounds such as polyethylene and polypropylene.

POLYPARAPHENYLENE TEREPHTHALAMIDE - This synthetic has high tensile strength at low weight, low elongation to break, high modulus (structural rigidity), low electrical conductivity, high chemical resistance, low thermal shrinkage, high toughness (work-to-break), excellent dimensional stability, high cut resistance, flame-resistant, and self-extinguishing properties. Trade name KEVLAR®. KEVLAR® is a trademark of the DuPont de Nemours Co.

POLYPROPYLENE - A thermoplastic polymer of propylene with good electrical characteristics, high tensile strength, and resistance to heat.

POLYSTYRENE - A rigid transparent thermoplastic of good physical and electrical insulating properties used especially in molded products, foams, and sheet materials. Abbreviation PS.

POLYSULFONE - A polymer highly resistant to mineral, acid, alkali, and salt conditions. Good dielectric properties up to 350° F.

POLYTETRAFLUOROETHYLENE - This is modified ETFE, a copolymer of ethylene and tetrafluoroethylene. This is the most thermally stable and chemically resistant carbonaceous insulating compound. It is unaffected by sunlight, moisture, and practically all chemicals. Temperature range is -90° C to 250° C and electrical properties are very constant over the temperature range and a wide range of frequencies. This insulation may be applied by extrusion, taping, dip-coating, and in cases where other material is used, by dispersion coating. Both conventional and ribbon type wires and cables are made as well as magnet wire. This insulation material is used as dielectric, insulation, and extruded jackets. Abbreviation is PTFE. Most common trade name is Teflon®. Teflon® is a trademark of the DuPont de Nemours Co.

POLYURETHANE - Enamel that has excellent moisture resistance, easily soldered, also has excellent winding properties as a magnet wire insulation. Abbreviation PU.

POLYVINYLCHLORIDE - A family of insulating compounds whose basic ingredient is either polyvinylchloride or its copolymer with vinyl acetate, in combination with appropriate plasticizers, stabilizers, fillers, and pigments. Like many other plastic materials, these insulations can be compounded to provide a wide variety of properties for various applications. Among the properties obtained are: Resistance to moisture, cold, heat, flame, oils, solvents, chemicals, and ozone. Electrical properties are adequate for low voltage power applications. Temperature ratings up to 105° C are recognized by UL for certain applications. These insulations are widely used for types T and TW building wires, series street lighting cable, machine tool wiring, hook-up and appliance wiring, overhead line wire, control and signal cables, and many others. Known as PVC or Vinyl. Abbreviation PVC.

POLYVINYLIDENE FLUORIDE - VF₂ vinylidene fluoride resin is a crystalline, high molecular weight polymer of VF₂ having high dielectric strength as well as abrasion resistant characteristics. This thermoplastic resin, a fluorocarbon, is characterized by good mechanical, electrical, and chemical properties. In primary insulation and in jackets for multi-conductor cables, it has a temperature range of -80° F to 300° F. This material can be extruded, applied as a film or solution, or by dispersion coating. This compound offers excellent resistance to abrasion and cut-through. Radiation cross-linking provides improved heat resistance. Abbreviation PVDF. Known as Kynar®. Kynar® is a trademark of the Pennwalt Corporation.

PORTABLE POWER CABLE - Extra flexible, all rubber insulated to allow hard usage. Some cables have additional protection of shielded conductors, metallic or nonmetallic, and can have Neoprene® sheath overall. Neoprene® is a trademark of the DuPont de Nemours Co.

POTENTIAL DIFFERENCE - The difference in electric potential between two points, equal to the line integral of the electric field strength between points. If a charge is moved from one

California

1959 East Cashdan Street, Rancho Dominguez, CA 90220
(310) 609-1811 • (800) 326-0006 • FAX: (310) 609-1862
E-Mail: salesrd@std-wire.com

Arizona

3120 West Thomas Road, Bldg. #801, Phoenix, AZ 85017
(602) 269-2501 • (800) 325-6478 • FAX: (602) 278-7134
E-Mail: salesphx@std-wire.com



Standard Wire & Cable Co.

to the other of the points by any path, the work done is equal to the product of the potential difference per unit length.

POTTING - The sealing of a cable termination or other component with a liquid which thermosets into an elastomer making the joint moisture proof or air tight.

POWER CABLE - A cable of various sizes, various constructions, and insulations used to supply power to a variety of types of equipment.

POWER FACTOR - The ratio of resistance, **R**, to impedance, **Z**. The ratio of the actual power of an alternating current to apparent power. Mathematically, the cosine of the angle between the voltage applied and the current resulting.

POWER FREQUENCY - The frequency at which domestic and industrial mains electricity is supplied and distributed. In the U.K. the standard value is 50 hertz; in the U.S. it is 60 hertz.

POWER LINE - See transmission line.

POWER RATING - AC voltage that can be applied between adjacent conductors.

POWER RATIO - The ratio of power appearing at the load to the input power. Expressed in db, it is equal to $10 \log_{10} (P_1/P_2)$ where P_1 is input power and P_2 is the power at the load.

PPE - Abbreviation for polypropylene ethylene.

PRESSURE CABLE - Oil impregnated, paper insulated conductors. Lead or steel pipe outer covering, in which positive pressure is constantly maintained. Has higher dielectric strength, greater insulation stability, increased current-carrying capacity, and saves space.

PRICE'S GUARD WIRE - A wire conductor used to prevent surface leakage current associated with an insulator from reaching the measuring instrument during determination of insulation resistance, particularly of cables.

PRIMARY INSULATION - The first layer of nonconductive material applied over a conductor, whose prime function is to act as electrical insulation.

PRIMARY VOLTAGE - Initial or main voltage.

PROP. - Abbreviation for propagation.

PROPYLENE - A flammable gaseous hydrocarbon C_3H_6 obtained by cracking petroleum hydrocarbons.

PS - Abbreviation for polystyrene. See polystyrene.

psi - Abbreviation for pounds per square inch.

PS TAPE - Nonmetallic shielding, very flexible. Remains in positive contact with insulation. Prevents formation of air gaps between conductor and insulation.

PTFE - Abbreviation for polytetrafluoroethylene. See polytetrafluoroethylene. Most common trade name is Teflon®. Teflon® is a trademark of the DuPont de Nemours Co.

PU - Abbreviation for polyurethane. See polyurethane.

PUFF - Colloquial term for one picofarad. See picofarad.

PULLING EYE - A device on the end of a cable to which a pulling line is attached for pulling the cable into a conduit or duct.

PULSE CABLE - Type of coaxial cable with or without a magnetic core constructed to transmit repeated high voltage pulses without degradation. Usually multi-shielded.

PULSE COMMUNICATIONS - Telecommunications involving the transmission of information by means of pulse modulation. Pulse communication is used in systems that operate by means of time-division multiplexing.

PUNCTURE VOLTAGE - The value of voltage that causes an insulator to be punctured when it is subjected to a gradually increasing voltage.

PUT UP - Packaging of finished wire or cable.

PVC - Abbreviation for polyvinylchloride. See polyvinylchloride.

PVC-I - Abbreviation for black polyvinylchloride, contaminating, type I, per MIL-C-17.

PVC-II - Abbreviation for gray polyvinylchloride, contaminating, type II, per MIL-C-17.

PVC-IIA - Abbreviation for black polyvinylchloride, contaminating, type IIA, per MIL-C-17.

PVC-IV - Abbreviation for black polyvinylchloride, contaminating, type IV, per MIL-C-17.

PVC-105° C - Specially compounded high temperature polyvinylchloride.

PVD - Abbreviation for polyvinylidene fluoride, Kynar®. Also abbreviated PVDF. See polyvinylidene fluoride. Kynar® is a trademark of the Pennwalt Corporation.

PVDF - Abbreviation for polyvinylidene fluoride, Kynar®. Also abbreviated PVD. See polyvinylidene fluoride. Kynar® is a trademark of the Pennwalt Corporation.



Q BAND - A band of microwave frequencies. See frequency band.

California

1959 East Cashdan Street, Rancho Dominguez, CA 90220
(310) 609-1811 • (800) 326-0006 • FAX: (310) 609-1862
E-Mail: salesrd@std-wire.com

Arizona

3120 West Thomas Road, Bldg. #801, Phoenix, AZ 85017
(602) 269-2501 • (800) 325-6478 • FAX: (602) 278-7134
E-Mail: salesphx@std-wire.com



Standard Wire & Cable Co.

QPL - Abbreviation for Qualified Products List issued by a United States Government Agency.

QUAD - A four conductor cable.

R

R - a) Symbol for resistance (see resistance) or resistor. b) 600 volt copper conductor stranded or solid, rubber insulated, cotton braid (rubber filled tape 6 AWG and larger). Cotton braid saturated with moisture resisting, flame-retarding compound smoothly finished. Used for power wiring. c) Abbreviation for riser.

RAD - The unit of measure for a radiation dose which is absorbed, equal to 0.01 joule per kilogram.

RADAR - Acronym for **radio detecting and ranging**. A system that measures distances and usually the direction to an object by determining the amount of time required for electromagnetic energy to travel to and return from the object.

RADIO - A general term, principally an adjective, applied to the use of electromagnetic waves between 10 KHz and 3 GHz and, in particular, their transmission through space.

RAM EXTRUDER - Wire making machinery for pressure and heat extruding Teflon® insulation over a conductor. A predetermined amount of cylindrical shaped molded Teflon® powder is placed in a cylinder chamber. A ram is pushed through the cylinder by a jack screw, forcing the Teflon® through an orifice or tip through which the conductor is moving and forms a homogeneous tube of insulation around the conductor. The unsintered insulated wire is then passed through a curing oven to complete the process. The limitation of a ram extruder is the size of the slug of preformed Teflon® powder. Since it is of constant size, when the slug is exhausted it is the end of the run. It cannot be continuously fed. As the diameter increases, the maximum length of wire to be covered decreases. Teflon® is a trademark of the DuPont de Nemours Co.

RATED TEMPERATURE - The maximum temperature at which an electric component can operate for extended periods without loss of its basic properties.

RATED VOLTAGE - The maximum voltage at which an electric component can operate for extended periods without undue degradation or safety hazard.

REACTANCE - The part of the total impedance of a circuit not due to pure resistance, measured in ohms. Symbol **X**. It is the imaginary part of the complex impedance, **Z** given by:

$$Z = R + iX$$

where **R** is resistance, **X** is reactance and **i** equals $\sqrt{-1}$.

Reactance is due to the presence of capacitance or inductance in a circuit. The effect of reactance is to cause the voltage and current to become out-of-phase.

RECEIVER - A detector and electronic circuitry to change optical signals to electrical signals.

REEL - Circular container on which wire is wound for storage or transit, usually made of wood or metal.

REFLECTION LOSS - The part of a signal which is lost due to reflection of power at a line discontinuity.

REFLOW SOLDERING - The process of connecting two solder coated conductive surfaces by remelting of the solder to cause fusion.

REFRACTIVE INDEX - The ratio of the speed of light in a vacuum to the speed of light in a material. Also called Index of Refraction.

REFRACTION - Deflection from a straight path undergone by a light ray or energy wave in passing obliquely from one medium (as air) into another (as glass) in which its velocity is different.

REPEATER - A device that receives signals in one circuit and automatically delivers corresponding signals to one or more other circuits, usually amplifying the signal.

RESIN - A solid or semisolid organic substance, originally of plant origin but largely synthesized now. It may be clear, yellowish, or brown, ranging from transparent to translucent; typically a nonconductor of electricity and soluble in organic solvents but not in water. Consequently, resins are widely used in insulating, potting, and encapsulating. Resins are broadly classified as thermoplastic or thermosetting according to whether they soften or harden with the application of heat.

RESISTANCE - The tendency of a material to resist the passage of an electric current and to convert electrical energy into heat energy. Symbol **R**. It is the ratio of the applied potential difference across a conductor to the current flowing through it (see Ohm's law). If the current is an alternating current, the resistance, measured in ohms, is the real part of electrical impedance, **Z**, given by the formula:

$$Z = R + iX$$

where **i** equals $\sqrt{-1}$ and **X** is the reactance.

RESISTANCE WIRE - Wire constructed from a material, such as Nichrome® or constantan, that has a high resistivity and low temperature coefficient of resistance. It is used for accurate wire-wound resistors. Nichrome® is a trademark of the Driver Harris Company.

RESISTIVITY - An intrinsic property of a material equal to the resistance per unit length and unit cross sectional area.

California

1959 East Cashdan Street, Rancho Dominguez, CA 90220
(310) 609-1811 • (800) 326-0006 • FAX: (310) 609-1862
E-Mail: salesrd@std-wire.com

Arizona

3120 West Thomas Road, Bldg. #801, Phoenix, AZ 85017
(602) 269-2501 • (800) 325-6478 • FAX: (602) 278-7134
E-Mail: salesphx@std-wire.com



Standard Wire & Cable Co.

Reciprocal of conductivity. The lower the resistivity of a material the better conductor it is. Materials can be classified as conductors, semiconductors, or insulators according to their resistivity. Conductors have a resistivity of 10^{-6} to 10^{-8} ohms per meter, semiconductors have a resistivity of 10^{-6} to 10^{-7} ohms per meter, and insulators have a resistivity of 10^{-7} to 10^{23} ohms per meter.

RESPOOL - To rerun material from one package spool to another for various purposes, such as to verify lengths, inspect for defects, or to a specified packaging by customer.

RETRACTILE CORD - A cord in which the insulation and/or jacket has been specially treated so that it will return to its original contracted form from an extended condition.

REV. - Abbreviation for revision.

RF - a) Abbreviation for radio frequency. b) Tinned copper conductors, rubber insulation, cotton braid saturated with moisture resisting, flame-retarding compound, smoothly finished in white, black, red, green, blue, and yellow for identification. The lubricated surface finish of the wire permits easy pulling through conduits.

RF CONNECTOR - Connector used for connecting or terminating coaxial cable.

RFI - Abbreviation for radio frequency interference.

RG - Abbreviation for Radio Frequency (Government). Prefix for many coaxial cables.

RHRW - Tinned copper conductors, rubber insulation, saturated braid, flame and moisture resistant finish for moist locations.

RHW - 75°C rubber insulated. Heat and moisture resistant insulation with an outer cover of moisture resistant, flame-retardant and a nonmetallic covering. Generally used in wet locations.

RIBBON CABLE - A flat cable with individually insulated conductors processed together in a parallel position. Conductors may be all in one color, or each individual conductor may be of a different color.

RIDGE MARKER - One or more ridges running laterally along the outer surface of plastic wire for purposes of identification.

RIGID COAXIAL CABLE - Nonflexible coaxial cable, usually a metal tube armored coaxial cable.

RIGID WAVEGUIDE - A type of coaxial cable. A metal form (usually an extrusion) using air as a dielectric.

RIM Helix - Abbreviation for resin insulated magnet wire.

RIP CORD - A parallel construction of two or more insulated conductors which may be easily separated leaving the insulation of the conductors undisturbed.

RISER - A UL designation for cable approved to go from one floor to another floor in a multistory building.

RMS - Abbreviation for Root Mean Square. It is a means of expressing AC voltage in terms of DC. It is approximately 80% of AC peak voltage.

ROENTGEN - The amount of radiation that will produce one electrostatic unit of ions per cubic centimeter volume.

ROPE LAY STRAND - A conductor made of multiple groups of filaments. A 7 x 19 rope lay strand has 19 wires laid into a group and then 7 such groups laid cabled into a conductor.

RR - An all rubber nonmetallic underground cable suitable for direct burial in the earth or in conduit. It has heat and moisture resistant insulation and an outer Neoprene® jacket. Neoprene® is a trademark of the DuPont de Nemours Co.

RUB - Abbreviation for rubber.

RUBBER MOLD - A metal mold containing a cavity that will give the desired form or part. The part is made by placing uncured rubber or synthetic compound in the cavity and curing under heat and pressure.

S

S - a) Abbreviation for silver-plated copper. Also abbreviated as SPC. b) 600 volt senior service rubber insulated portable cord. 18 AWG two conductor through 6 AWG four conductor.

2S - Abbreviation for silver-plated copper double shield.

SA - a) Abbreviation for silver-covered alloy. b) Nomenclature for silicone rubber insulation with high temperature barrier or glass overall for use up to 125° C.

S BAND - A band of microwave frequencies. See frequency band.

SC - Abbreviation for silver-covered copper. Also abbreviated as SCC.

2SC - Abbreviation for two silver-plated copper shields.

SCB - Abbreviation for silver-plated cadmium bronze. Also abbreviated as SCCad Br.

SCBerC - Abbreviation for silver-covered beryllium-copper alloy.

SCC - Abbreviation for silver-covered copper. Also abbreviated as SC.

SCCA - Abbreviation for silver-covered copper-clad aluminum. Also abbreviated SCCAL.

SCCad Br - Abbreviation for silver-covered cadmium bronze. Also abbreviated as SCB

California

1959 East Cashdan Street, Rancho Dominguez, CA 90220
(310) 609-1811 • (800) 326-0006 • FAX: (310) 609-1862
E-Mail: salesrd@std-wire.com

Arizona

3120 West Thomas Road, Bldg. #801, Phoenix, AZ 85017
(602) 269-2501 • (800) 325-6478 • FAX: (602) 278-7134
E-Mail: salesphx@std-wire.com



Standard Wire & Cable Co.

SCCAL - Abbreviation for silver-covered copper-clad aluminum. Also abbreviated SCCA.

SCCS - Abbreviation for silver-covered copper-clad steel. Also abbreviated as SCS.

SCHSCA - Silver-coated high strength copper alloy.

SCPE - Semiconducting polyethylene.

SCS - Abbreviation for silver-covered copper-clad steel. Also abbreviated as SCCS.

SCW - Abbreviation for silver-plated Copperweld® conductor. Copperweld® is a trademark of the Copperweld Steel Company.

SD - Abbreviation for soft drawn (annealed).

SECONDARY INSULATION - A high resistance dielectric material which is placed over primary insulation to protect it from abrasion.

SECTOR STRAND - A group of wires laid in triangular shape with rounded corners, for use as one conductor of a three conductor cable with 120° angle between faces, and with 90° angle for a four conductor cable.

SEGMENTAL CONDUCTOR - In single conductor cables one million (1,000,000) CM or more, the conductors are divided into three or four segments, insulated from each other by paper tapes, to reduce current resistance in AC circuits.

SELENIUM CURE - Process used in curing Neoprene® and rubber jacketed wires and cables. The process makes a dense, tough, durable jacket. Neoprene® is a trademark of the DuPont de Nemours Co.

SELF-EXTINGUISHING - The characteristic of a material whose flame is extinguished after the igniting flame is removed.

SELF-SUPPORTING AERIAL CABLE - A cable consisting of one or more insulated conductors assembled or cabled with a steel core or attached to a separate steel cable, which supports the weight of the cable. It may be from pole to pole or in a vertical position on a tower.

SELF-SUPPORTING CABLE - A cable with a steel support strand capable of supporting the cable weight across spans.

SEMICONDUCTING JACKET - A jacket having a sufficiently low resistance so that its outer surface can be kept at substantially ground potential by a grounded conductor in contact with it at frequent intervals.

SEMICONDUCTOR - Any of a class of solids whose electrical conductivity is between that of a conductor and that of an insulator in being nearly as great as that of a metal at high temperatures and nearly absent at low temperatures.

SEMIRIGID - Rigid to some degree or in some part.

SEMITIGHT BUFFER - Type of optical fiber cable construction where each fiber is loosely surrounded by a protective coating to a diameter of 900 microns.

SEPARATOR - Layer of insulating material between: (a) Conductors and insulation; and (b) Between cable components and jacket.

SERVING OF A CABLE - A serve is a separator applied directly over the conductor. The serve may consist of one or a combination of materials such as paper, cotton, silk, nylon, or rayon. These materials may be applied spirally or laterally.

SF - Fixture wire, silicone rubber insulated. Can be solid or stranded.

SFF - Same as SF but in flexible grade stranding.

SH-A - Portable power cable, commonly known as shovel cable, Neoprene® jacket, usually three or four conductors individually shielded. Cable rated 5 kV. Neoprene® is a trademark of the DuPont de Nemours Co.

SH-B - Similar to SH-A except shield over all conductors.

SH-C - Similar to SH-B except with grounds.

SH-D - Similar to SH-A except with grounds.

SHEATH - The outer covering or jacket over the insulated conductors to provide mechanical protection for the conductors.

SHF - Abbreviation for super high frequency. See frequency band.

SHIELD - In cables, a metallic layer placed around a conductor or group of conductors to prevent electrostatic or electromagnetic interference between the enclosed wires and external fields.

SHIELD COVERAGE (PERCENTAGE) - The physical area of a cable that is actually covered by the shielding material and is expressed in percent.

SHIELDED CONDUCTOR - An insulated conductor which has been shielded by a copper braid or tape, aluminum foil, copper foil, or a semiconductive vinyl. The purpose is to confine the electrical field.

SHIELDED MULTI-CONDUCTOR CABLE - A cable with a multiplicity of conductors with a metallic or nonmetallic shield over the cable core.

SHORTS - Less than standard lengths of wire or cable which are generated by making cuts for special orders, i.e., remnants.

California

1959 East Cashdan Street, Rancho Dominguez, CA 90220
(310) 609-1811 • (800) 326-0006 • FAX: (310) 609-1862
E-Mail: salesrd@std-wire.com

Arizona

3120 West Thomas Road, Bldg. #801, Phoenix, AZ 85017
(602) 269-2501 • (800) 325-6478 • FAX: (602) 278-7134
E-Mail: salesphx@std-wire.com



Standard Wire & Cable Co.

SHRINK TUBING - A thermoplastic tube, when heated, shrinks and cures to a smaller diameter. Used to seal joints, etc.

SHUNT WIRE - A conductor joining two parts of an electric circuit to divert part of the current.

SIGNAL - A current used to convey information, either digital, analog, audio, or video.

SIGNAL CABLE - A cable designed to carry current of less than 1 ampere per conductor.

SIGNAL GENERATOR - A device used to furnish current at a known frequency, modulated, and to deliver a measured voltage only at the terminals of the generator without appreciable radiation at any other point.

SIGNAL-TO-NOISE RATIO - At any point in an electronic circuit, device, or transmission system, the ratio of one parameter of a desired signal to the same or corresponding parameter of the noise. In broadcast communication the signal-to-noise ratio is often quoted in decibels and the noise parameter taken as its root mean square value.

SIL/DAC-VI - Abbreviation for Dacron braid over silicon rubber, Type VI, per MIL-C-17.

SILICONE - A thermoplastic elastomer insulation with excellent heat resistance.

SILICONE IMPREGNATED - The complete saturation of insulating tapes or braids with a silicone varnish compound. The process may be performed under a vacuum. The compound serves as a heat and flame-retardant as well as a binder.

SIMPLEX CABLE - A single fiber optical cable.

SINGLE-MODE FIBER - An optical waveguide in which only one mode propagates due to its small core diameter of approximately 9 microns.

SINTERED - Usually refers to curing of Teflon®. To cause to become a coherent mass by heating without melting. Teflon® is a trademark of the DuPont de Nemours Co.

SIS - XLP (cross-linked polyolefin) switchboard wire.

SJ - 300 volt junior service rubber insulated UL approved portable cord, rubber jacket. 18 AWG two conductor through 16 AWG four conductor.

SJO - 300 volt junior service rubber insulated UL approved portable cord, Neoprene® jacket. Neoprene® is a trademark of the DuPont de Nemours Co.

SJT - 300 volt junior service vinyl insulated UL approved portable cord, vinyl jacket.

SJTO - 300 volt. Same as SJO except all thermoplastic construction.

SKELETON BRAID - Widely separated braid of fiber, copper, or steel may be used to hold core together, for reinforcing jacket or for shielding.

SKIN EFFECT - In an alternating current system, a phenomenon that occurs at increased frequencies causing an increase in resistance of the conductor causing the outer skin to carry most of the current. The phenomenon increases in intensity the higher the frequency.

SLEEVING - A braided, knitted, woven tube.

SNCCS - Abbreviation for silver-covered nickel-covered copper-clad steel.

SO - A 600 volt senior service Neoprene® jacket UL approved portable cord; 18 AWG two conductor through 10 AWG four conductor. Neoprene® is a trademark of the DuPont de Nemours Co.

SOLDER - A metal or metallic alloy used when melted to join metallic surfaces; an alloy of lead and tin so used.

SOLDERABLE NYLON LITZ - Litz wire made up of solderize strands with a nylon serve overall.

SOLDEREZE - Magnet wire insulated with polyurethane base enamel.

SOLID CONDUCTOR - A conductor composed of one wire. Generally 18 AWG through 6 AWG, used where flexibility is not required.

SONAR - Acronym from **sound navigation ranging**. A method of detecting and locating underwater objects by transmitting a pulse of sound energy, usually ultrasonic, then measuring the return "reflected" echo.

SP-1 - Lamp cord, parallel, all rubber, two conductor, 300 volt.

SP-2 - Similar to SP-1 except heavier insulation.

SP-3 - Similar to SP-1 except heavier insulation, also may have a ground.

SPACE FACTOR - Given values in coil winding for amount of space available.

SPARK TEST - A test given to wire or cable to determine if there are defects in the insulation. A semi-destructive test, in that it will find weak spots in insulation by a spark breaking through thin spots or pinholes in the jacket when a high voltage potential from the conductor to an outside source is applied. Where these sparks emanate, the cable is cut, thus shortening the cable. This test should only be run once on a wire or cable.

SPC - Abbreviation for silver-plated copper. Also abbreviated as S.

SPECIFIC GRAVITY - The ratio of the density (mass per unit volume) of a material to that of water.

California

1959 East Cashdan Street, Rancho Dominguez, CA 90220
(310) 609-1811 • (800) 326-0006 • FAX: (310) 609-1862
E-Mail: salesrd@std-wire.com

Arizona

3120 West Thomas Road, Bldg. #801, Phoenix, AZ 85017
(602) 269-2501 • (800) 325-6478 • FAX: (602) 278-7134
E-Mail: salesphx@std-wire.com



Standard Wire & Cable Co.

SPECIFIC INDUCTIVE CAPACITY - Dielectric constant of insulating material. Abbreviated as K, SK, SIC.

SPHINCTER RING - A high ratio heat shrinkable strain relief grommet that can be placed over the cable assembly after the assembly is fabricated.

SPIRAL SHIELD - A metallic shield of fine stranded wires applied spirally rather than braided.

SPIRAL WRAP - The helical wrap of a material over a core.

SPLICE - A permanent joint between two optical waveguides.

SPOOL - Circular container on which wire is wound for storage or transit, usually made of plastic, paper, or metal.

SP SHIELD - Abbreviation for silver-plated shield.

SPT-1 - Same as SP-1 except in plastic.

SPT-2 - Same as SP-2 except in plastic.

SPT-3 - Same as SP-3 except in plastic.

sq. - Abbreviation for square.

SR - Abbreviation for silicone rubber insulated cable, 600 volt.

SRAW - Abbreviation for silicone rubber insulated, overall glass braid, with nickel-plated copper conductor, flexible stranding, 600 volt.

SRL - Abbreviation for structural return loss.

SRML - Abbreviation for silicone rubber motor lead.

SS - Abbreviation for stainless steel.

SSC - Abbreviation for silver-covered strip.

SSPE - Abbreviation for semisolid polyethylene. Also abbreviated as SS poly.

SS Poly - Abbreviation for semisolid polyethylene. Also abbreviated as SSPE.

SSPS - Abbreviation for semisolid polystyrene.

SSTFE - Abbreviation for semisolid tetrafluorethylene, Teflon®. Teflon® is a trademark of the DuPont de Nemours Co.

SSTUBE - Abbreviation for stainless steel tube.

ST - Same as SJT, except 600 volt.

STABILITY FACTOR - The difference between the percentage power factor at 80 volts/mil and at 40 volts/mil measured on wire immersed in water at 75° C for a specific time.

STANCOTE® - Standard Wire & Cable Co. trade name for plastic insulated wire.

STANDING WAVE RATIO - In a transmission line, waveguide or analogous system, a figure of merit used to express the efficiency of the system in transmitting power, specifically taking into account the mismatch between source, line, and load. The standing wave ratio **S** is given by the formula:

$$S = V_{\max} / V_{\min} = I_{\max} / I_{\min}$$

In an ideally matched system, **S**=1 indicating the presence of a pure traveling wave and no reflected power. As the proportion of power reflected increases, **S** approaches infinity, which value would indicate a pure standing wave.

STANFLEX® - Standard Wire & Cable Co. trade name for rubber jacketed portable cords and cables.

STATIC - Disturbing effects produced in a radio, telephone, or television receiver by atmospheric or various natural or man-made electrical disturbances.

STATIONARY DUTY - See continuous duty.

STEP INDEX - In fiber optics the refractive index profile characterized by a uniform refractive index within the core and a sharp decrease at the core cladding interface. It usually refers to a multi-mode fiber.

STRAND - A single uninsulated wire.

STRANDED CONDUCTOR - A conductor made with a specified number of strands. Rope lay strand, for example, is a conductor made of multiple groups of strands (filaments). A 7 x 19 rope lay strand has 19 wires laid into a group and then seven such groups cabled laid into a conductor.

STRENGTH MEMBER - Included in a cable configuration for purposes of adding tensile strength only. Does not conduct any power or signal.

STRIP INSULATIONS - Strip process insulation consists of one or more longitudinal strips of unvulcanized thermosetting material folded around a conductor and vulcanized after application.

SUBMARINE CABLE - Cable used underwater from one point to another for power or communication. Lead sheath and/or rubber jacket.

SUBSTRATE - Insulating material of a printed circuit.

SUGGESTED WORKING VOLTAGE - Usually refers to the AC voltage that can be applied between adjacent conductors.

SUPER HIGH FREQUENCY - See frequency band.

SUSCEPTANCE - Symbol **B**. The imaginary part of the admittance, **Y**, which is given by:

$$Y = G + iB$$

California

1959 East Cashdan Street, Rancho Dominguez, CA 90220
(310) 609-1811 • (800) 326-0006 • FAX: (310) 609-1862
E-Mail: salesrd@std-wire.com

Arizona

3120 West Thomas Road, Bldg. #801, Phoenix, AZ 85017
(602) 269-2501 • (800) 325-6478 • FAX: (602) 278-7134
E-Mail: salesphx@std-wire.com



Standard Wire & Cable Co.

where **G** is the conductance and **i** equals $\sqrt{-1}$. For a circuit containing both resistance, **R**, and reactance, **X**, the susceptance is given by:

$$B = -X / (R^2 + X^2)$$

SV - Vacuum cleaner cord 18/2, 300 volt, light duty rubber, portable.

SVO - Same as SV except with Neoprene® jacket. Neoprene® is a trademark of the DuPont de Nemours Co.

SVT - Same as SV except nonmarking plastic jacket.

SWEEP TEST - A method to determine the frequency response of a cable by generating an RF voltage whose frequency is varied at a rapid constant rate over a given range. A test commonly made on coaxial cables.

SWEPT COAX - Coaxial cable which has been checked by the sweep test and certified by the manufacturer.

SWITCHBOARD WIRE - High temperature insulated wire such as TA or AVB, used to wire switchboards and control apparatus. It is heat, flame, and corrosive vapor resistant.

SYN. RUB. - Abbreviation for synthetic conductive rubber.

SYNTH - Abbreviation for synthetic.

T

T - The old UL designation for switchboard wire insulated with thermoplastic lead wire.

TA - The UL designation for switchboard wire insulated with thermoplastic and a high temperature barrier.

TAGT - Stranded nickel-clad copper conductor insulated with fused Teflon® tape, high temperature barrier, and Teflon® impregnated glass braid. 600 volt, 250°C rating. Teflon® is a trademark of the DuPont de Nemours Co.

TANK TEST - A voltage dielectric test in which the test sample is submerged in water and voltage is applied between the conductor and water as ground.

TC - a) Abbreviation for tinned copper. b) Type TC power and control tray cable.

2TC - Abbreviation for tinned copper double shield.

3TC - Abbreviation for tinned copper triple shield.

4TC - Abbreviation for tinned copper quadruple shield.

TCCS - Abbreviation for tinned copper-clad steel.

TCW - Abbreviation for tinned Copperweld®. Copperweld® is a trademark of the Copperweld Steel Company.

TEFLON® - Teflon® is DuPont de Nemours Co.'s trade name for their family of fluorocarbon resins including Teflon® TFE (tetrafluoroethylene), Teflon® FEP (fluorinated ethylene propylene), and Teflon® PFA (perfluoroalkoxy). See tetrafluoroethylene and perfluoroalkoxy.

TEFLON® IMPREGNATED - Refers to the saturation of a heat resistant fibrous glass braid with Teflon® suspension. After saturation, the Teflon® is cured. Teflon® is a trademark of the DuPont de Nemours Co.

TEFZEL® - Trademark of the DuPont de Nemours Co. Abbreviation ETFE. See ethylene tetrafluoroethylene.

TELEMETRY CABLE - Cable used for the transmission of information from instruments to the peripheral recording equipment.

TELEPHONE WIRE - This is a general term referring to many different types of communication wire. It refers to a class of wires and cables rather than a specific type.

TELLURIUM CURE - A curing process similar to selenium cure, except a different element is used.

TEMP. - Abbreviation for temperature.

TEMPERATURE COEFFICIENT OF RESISTANCE - The amount of resistance change of a material per degree of temperature change.

TEMPERATURE RATING - The maximum temperature at which an insulating material may be used in continuous operation without loss of its basic properties.

TENSILE STRENGTH - The pull stress required to break a given specimen. In fiber optics, the maximum allowed pulling force until a specific attenuation is reached. The stated value is short-term.

TERMINAL - Any fitting used for making a convenient electrical connection.

TEST LEAD - A flexible, insulated lead wire which usually has a test probe on one end. It is ordinarily used for making temporary electrical connections. The insulation normally is rubber, the standard colors are red and black.

TEST REPORTS - The permanent records made by a wire manufacturer of the tests performed on a batch of wire to a specification.

TETRAFLUOROETHYLENE - A fluorocarbon resin. Abbreviation TFE. Trade name is Teflon®. Teflon® is a trademark of the DuPont de Nemours Co.

TEW - Nomenclature for appliance wire by Canadian Standards Association (CSA), plastic insulated, solid or stranded conductor, 600 volt.

California

1959 East Cashdan Street, Rancho Dominguez, CA 90220
(310) 609-1811 • (800) 326-0006 • FAX: (310) 609-1862
E-Mail: salesrd@std-wire.com

Arizona

3120 West Thomas Road, Bldg. #801, Phoenix, AZ 85017
(602) 269-2501 • (800) 325-6478 • FAX: (602) 278-7134
E-Mail: salesphx@std-wire.com



Standard Wire & Cable Co.

TEXTILE BRAID - Any braid made from threads of cotton, silk, or synthetic fibers.

TF - The UL designation for fixture wire, solid soft copper conductor, insulated with thermoplastic lead wire.

TFE - Abbreviation for tetrafluoroethylene, Teflon® TFE. See tetrafluoroethylene. Teflon® is a trademark of the DuPont de Nemours Co.

TFF - Same as TF, except stranded copper conductor.

TG - Teflon® tape with overall glass braid, stranded nickel-clad copper conductor. Teflon® is a trademark of the DuPont de Nemours Co.

TGGT - Flexible stranded nickel-coated copper conductor with PTFE Teflon® tapes, covered by wrapped fiberglass yarns. A fiberglass braid jacket is applied over insulation and is treated with high-temp saturant. 600 volt, 250°C rating. Teflon® is a trademark of the DuPont de Nemours Co.

THERMAL RATING - The maximum and/or minimum temperature at which a material will perform its function without undue degradation.

THERMAL RESISTANCE - The resistance of a substance to conductivity of heat.

THERMAL SHOCK - A test to determine the ability of a material to withstand heat and cold by subjecting it to rapid and wide changes in temperature.

THERMOCOUPLE - A union of dissimilar metals in which a voltage is generated due to a change in temperature. The voltage is usually in micro or milli volts.

THERMOCOUPLE EXTENSION - Same as thermocouple lead wire.

THERMOCOUPLE LEAD WIRE - An insulated pair of wires used from the couple to a junction box or to the recording instrument.

THERMOCOUPLE WIRE - Wire drawn from special metals or alloys and calibrated to established specifications such as for the U.S. Bureau of Standards or Instruments Society of American standards.

THERMOPLASTIC - A material which softens when heated and becomes firm on cooling.

THERMOSET - A material which hardens or sets when heat is applied, and which, once set, cannot be re-softened by heating. The application of heat is called "curing".

THERMOSTAT WIRE - Single or multi-conductor wire, bare soft solid copper conductor, usually PVC insulated. May be twisted and/or jacketed. May have enameled or nylon covered conductors and may have a metal armor covering. May also have a high temperature barrier insulation. It is used to

transmit electrical signals between the thermostat and the heating or cooling unit.

THHN - Building wire, plastic insulated, 90° C, 600 volt, nylon jacket. Used in dry locations.

THINNET - RG58 type coaxial cable used in local area network configurations.

THW - Building wire, plastic insulated, heat, flame, and moisture resistant, 75° C.

THWN - Same as THW with overall nylon jacket. Used in dry and wet locations.

TIGHT BUFFER - Type of fiber optic cable construction where each fiber is tightly buffered by a protective thermoplastic coating to a diameter of 900 microns.

TINNED COPPER - Tin coating added to a copper conductor or braid to aid in soldering and inhibit corrosion. Abbreviated as TC.

TINSEL CORD - Extra flexible cord made with tinsel conductors to give the ultimate in flexibility. Used mostly in the communications field on headsets, handsets, and anywhere that repeated flexibility is necessary.

TINSEL WIRE - A low voltage, stranded wire in which each strand is very thin copper ribbon spirally wrapped around a textile yarn. Insulation is generally a textile braid. Intended for use where severe flexing is expected.

TOKEN RING - A star-wired ring architecture used for computer LAN data communications.

TOLERANCE - a) The allowable deviation from a standard especially the range of variation permitted in maintaining a specified dimension in machining a piece; or b) The variance between the quantity ordered and the quantity shipped, generally accepted in the wire industry to be plus or minus 10%.

TOPCOAT - Bare (untinned) copper wire, stranded, then coated with pure tin.

TPDDI - Abbreviation for twisted pair distributed data interface.

TPE - A highly flexible jacket material of thermoplastic elastomer.

TP-PM D - Abbreviation for twisted pair physical medium dependent.

TR - Abbreviation for (certified) test reports. See certified test reports

TRACER STRIPE - When color coding is accomplished by more than one stripe on the same wire. The first stripe, or widest, is called the base stripe, the others, usually narrower, are called tracer stripes.

California

1959 East Cashdan Street, Rancho Dominguez, CA 90220
(310) 609-1811 • (800) 326-0006 • FAX: (310) 609-1862
E-Mail: salesrd@std-wire.com

Arizona

3120 West Thomas Road, Bldg. #801, Phoenix, AZ 85017
(602) 269-2501 • (800) 325-6478 • FAX: (602) 278-7134
E-Mail: salesphx@std-wire.com



Standard Wire & Cable Co.

TRANSFER MOLD - A type of rubber mold. The term derived from the method used of moving the compound into the cavity of the mold. The compound is forced or transferred by pressure, from a cavity in the top of the mold through sprues, into the lower section.

TRANSFORMER - A device for transferring electrical energy in an AC circuit by means of electromagnetic induction. Each circuit is represented by a winding around a common magnetic core, the ratio of the voltage in the two circuits being (in an ideal transformer) equal to the ratio of the number of turns. From Ohm's Law and the Conservation of Energy Principle, it follows that (except for losses) the product of current and voltage is the same in both circuits.

TRANSMISSION LINE - Synonymous with power line. One or more insulated conductors arranged to transmit electrical energy signals from one locality to another.

TRANSMITTER - A driver and a source used to change electrical signals to optical signals.

TRAP WIRE - A low voltage wire used at hinge points, where severe flexing occurs, usually in burglar alarm systems. It is made with tinsel conductor to withstand the repeated flexing.

TRAY - A metal raceway for holding cable.

TRAY CABLE - A factory assembled multi-conductor control, signal, and power cable specifically approved under the NEC for installation in trays.

TRIAD - A group of three insulated conductors twisted together with or without a sheath overall. Usually color coded for identification. Also called a triplex.

TRIAxIAL - Refers to a three conductor cable with one conductor in the center, a second circular conductor concentric with the first, and a third circular conductor insulated from and concentric with the first and second, usually with insulation, and a braid or impervious sheath overall.

TRIBOELECTRIC NOISE - Noise generated in a shielded cable due to variations in capacitance between shielding and conductor as the cable is flexed.

TRIPLEX - A group of three insulated conductors twisted and/or sheathed or held together mechanically. Usually color coded or ridge marked. Also called triad.

TUBING - A tube of extruded nonsupporting plastic or metallic material.

TV - Abbreviation for Television. The transmission of images by means of radio waves or wires.

TV CAMERA CABLE - A portable, flexible cable consisting of several coaxial cables and other conductors cabled together, overall shield and usually Neoprene® jacketed. It is used to carry signals between the camera and transmitter and plate and heater currents to the camera. Neoprene® is a trademark of the DuPont de Nemours Co.

TW - The UL designation for thermoplastic insulated wire for use in conduit, underground, and wet locations. It is a common building wire having a bare soft copper conductor, which may be either solid or stranded.

TWINAX - A shielded coaxial cable with two central conductors. Also called twinaxial.

TWINAXIAL - A shielded coaxial cable with two central conductors. Also called twinax.

TWIN CABLE - A pair of insulated conductors of 8 AWG or larger, twisted or laid parallel and/or sheathed or held together mechanically under a common covering.

TWIN WIRE - A pair of insulated conductors of 9 AWG or smaller, twisted or bonded together and not identifiable from each other.

TWISTED PAIR - Two insulated conductors twisted together without a common covering.

U

UF - Single or multi-conductor, with or without ground, used for direct burial underground feeders and branch circuits between buildings, yard lights, floodlights, and similar installations.

UG - The two letter designation that proceeds the number on connectors for coaxial cable. It means Universal Government.

UHF - Abbreviation for ultra high frequency. See frequency band.

UL - Abbreviation for Underwriters Laboratories Inc. A non-profit organization that maintains and operates laboratories for the examination and testing of devices, systems and materials relative to life, fire and casualty, hazards, and crime prevention. Founded in 1894, the enterprise is sponsored by the National Board of Fire Underwriters.

UL APPROVED - A product that has been tested and approved to Underwriters Laboratories standards.

ULTRA HIGH FREQUENCY - See frequency band. Abbreviation UHF.

UNBALANCED CIRCUIT - A transmission line in which voltage on the two conductors are unequal with respect to ground, e.g., a coaxial cable.

UNILAY CONDUCTOR - A central core surrounded by one or more concentric layers of helically wound strands in a fixed geometrical arrangement with the direction of lay the same for each layer and the central core.

UNSINTERED - Means uncured. This word is usually used to differentiate between cured and uncured Teflon® tape. Teflon® is a trademark of the DuPont de Nemours Co.

California

1959 East Cashdan Street, Rancho Dominguez, CA 90220
(310) 609-1811 • (800) 326-0006 • FAX: (310) 609-1862
E-Mail: salesrd@std-wire.com

Arizona

3120 West Thomas Road, Bldg. #801, Phoenix, AZ 85017
(602) 269-2501 • (800) 325-6478 • FAX: (602) 278-7134
E-Mail: salesphx@std-wire.com



Standard Wire & Cable Co.

UNSWEEP - Coaxial cable that has not had an attenuation check (sweep test).

URC - Nomenclature for weatherproof wire.

USASI - Abbreviation for United States of American Standards Institute. Superseded ASA and in turn was superseded by ANSI.

USE - Neoprene® jacketed underground service entrance cable. Neoprene® is a trademark of the DuPont de Nemours Co.

UTP - Abbreviation for unshielded twisted pair.

UV - Abbreviation for ultraviolet.

V

V - Abbreviation for voltage. See voltage.

VA - Abbreviation for volt-ampere. A designation of power in terms of volts and amperes.

V BAND - A band of microwave frequencies. See frequency band.

VEL. - Abbreviation for velocity.

VELCRO® - Set of nylon strips of interlocking barbs on one strip and hooks on another that can be fastened and unfastened repeatedly. Velcro® is a trademark of the Velcro Industries B.V.

VELOCITY OF PROPAGATION - Is the ratio of the speed of an electric signal down a length of cable compared to the speed of light in free space. All insulated cables have this ratio and it is expressed in percentage. It is the reciprocal of the square root of the dielectric constant of the cable insulation. For example, in the case of coaxial cables with polyethylene dielectric, this ratio is 65% to 66%.

VERTICAL RISER CABLE - Steel wire armored power cable for vertical runs in a building.

VERY HIGH FREQUENCY - See frequency band. Abbreviation VHF.

VERY LOW FREQUENCY - See frequency band. Abbreviation VLF.

VHF - Abbreviation for very high frequency. See frequency band.

VIDEO PAIR CABLE - A transmission cable containing low loss pairs with an impedance of 125 ohms. Used for TV pick ups, closed circuit TV, telephone carrier circuits, etc.

VITON® - A synthetic family of elastomer for high performance jacketing material. It possesses very good resistance to chemi-

icals, heat, fire, and good mechanical properties. Viton® is a trademark of DuPont Dow Elastomers.

VLF - Abbreviation for very low frequency. See frequency band.

VOLT - A unit of measure of electromotive force. One volt is the amount of pressure that will cause one ampere of current in one ohm of resistance. Abbreviation V.

VOLTAGE - The term most often used in place of electromotive force, potential difference, or voltage drop to designate the electric pressure that exists between two points and is capable of producing a current when a close circuit is connected between two points.

VOLTAGE BREAKDOWN - A test to determine maximum voltage of insulated wire before electrical current leakage through insulation occurs.

VOLTAGE RATING - The highest voltage which may be applied to a wire or cord for continuous service in conformance with the governing standards or specifications.

VOLUME RESISTIVITY (SPECIFIC INSULATION RESISTANCE) - The electrical resistance between opposite faces of a 1 centimeter cube of insulating material, commonly expressed in ohms per centimeter.

VS. - Abbreviation for versus.

VSWR - Abbreviation for Voltage Standing Wave Ratio. The ratio of the voltage maximum to voltage minimum which exists in a transmission line. Caused when there is reflection of incident wave, due to a discontinuity or improper match to the transmission line (see Standing Wave Ratio).

VW-1 - Vertical flame test for wire and cable. A standard established by Underwriters Laboratories. Formerly know as FR-1.

W

W - a) Abbreviation for watt. See watt. b) Heavy duty portable power cable, Neoprene® jacket, in single or multiple conductors, 600 volt. Neoprene® is a trademark of the DuPont de Nemours Co. c) Abbreviation for with.

WALL THICKNESS - Refers to insulation thickness or jacket thickness that has been applied.

WATER ABSORPTION - A test to determine the water absorbed by a material after a given immersion period.

WATER BLOCKED CABLE - A multi-conductor cable having voids filled to prevent water flow or wicking.

WATT - The unit of measure of electric power. One watt is equivalent to the power represented by one ampere of current under a pressure of one volt in a DC circuit. Abbreviation W.

California

1959 East Cashdan Street, Rancho Dominguez, CA 90220
(310) 609-1811 • (800) 326-0006 • FAX: (310) 609-1862
E-Mail: salesrd@std-wire.com

Arizona

3120 West Thomas Road, Bldg. #801, Phoenix, AZ 85017
(602) 269-2501 • (800) 325-6478 • FAX: (602) 278-7134
E-Mail: salesphx@std-wire.com



Standard Wire & Cable Co.

WAVEGUIDE - A transmission line that consists of a suitably shaped hollow conductor, which may be filled with a dielectric material, and that is used to guide ultrahigh frequency electromagnetic waves propagated along its length. The most common shapes of waveguide are rectangular and cylindrical; the most common dielectric is air. A cylindrical waveguide is sometimes known as a wave duct; one that contains a solid rod of dielectric is a uniconductor waveguide. If a wide range of frequencies is to be transmitted, a ridged waveguide may be used. The presence of the ridges extends the possible range of frequencies that may be propagated in a particular transmission mode but the transmission is greater than in the equivalent rectangular waveguide.

WAVEGUIDE DISPERSION - Dispersion caused by the fact that light travels at different speeds in the core and cladding of single-mode fibers.

WAVELENGTH - The distance, measured in the direction of propagation, of a repetitive electrical pulse or waveform between two successive points that are characterized by the same phase of vibration.

W BAND - A band of microwave frequencies. See frequency band.

WICKING - The longitudinal flow of a liquid in a wire or cable due to capillary action.

WIRE - A slender rod or filament of drawn metal. The term is a generally used one, which may refer to any single conductor. If larger than 9 AWG or multiple conductors, it is usually referred to as a cable.

WIRE BRAID - Flexible wire constructed of small size strands woven together in tubular form. Used for shielding or connections where constant flexing is required.

WIRE GAUGE - The American Wire Gauge, originally called Brown & Sharpe Gauge. A system of numerical wire sizes starting with the lowest numbers for the largest sizes. Gauge sizes are each 20.6% apart based on cross sectional area. Abbreviation AWG.

WOLLASTON WIRE - Extremely fine platinum wire that is used for electroscopes, microfuses, and hot-wire instruments. It is produced by coating platinum wire with a sheath of silver, drawing them together into a relatively fine uniform diameter wire, and then dissolving the silver with a suitable acid. Diameters to about one micrometer may be produced by this method.

WOVEN CABLES - A method of producing a flat or ribbon type cable by holding the conductors together with thread as a result of a weaving process.

X

X - Symbol for reactance. See reactance.

X-100 - See FEP.

X BAND - A band of microwave frequencies. See frequency band.

XETFE - Abbreviation for cross-linked extruded, modified ethylene tetrafluoroethylene copolymer. See ethylene tetrafluoroethylene.

X GUIDE - A transmission line that is used for the propagation of surface waves and consists of a length of dielectric material with a X-shaped cross section.

XHHW - Cross-linked polyethylene insulated, rated at 90° C in dry locations and 75° C in wet locations.

XL - Abbreviation for cross-linked insulation. See cross-linked.

XLAP - Abbreviation for cross-linked extruded alkane-imide polymer.

XLETFE - Abbreviation for cross-linked ethylene tetrafluoroethylene copolymer. See ethylene tetrafluoroethylene copolymer.

XLPE - Abbreviation for cross-linked polyethylene. Also abbreviated as XLPE.

XLPA - Abbreviation for cross-linked extruded polyalkene.

XLPE - Abbreviation for cross-linked polyethylene. Also abbreviated as XLP.

XL POLYOLEFIN - Cross-linked polyolefin.

XLPVF - Abbreviation for cross-linked extruded polyvinylidene fluoride.

Y

Y - Symbol for admittance. See admittance.

yrs. - Abbreviation for years.

Z

Z - Symbol for impedance. See impedance.

ZERO POTENTIAL - See earth potential.

ZIP CORD - Parallel cable that can be easily separated by pulling apart.

California

1959 East Cashdan Street, Rancho Dominguez, CA 90220
(310) 609-1811 • (800) 326-0006 • FAX: (310) 609-1862
E-Mail: salesrd@std-wire.com

Arizona

3120 West Thomas Road, Bldg. #801, Phoenix, AZ 85017
(602) 269-2501 • (800) 325-6478 • FAX: (602) 278-7134
E-Mail: salesphx@std-wire.com



DECIMAL EQUIVALENTS

	FRACTIONS OF ONE INCH				DECIMAL EQUIV. (IN)	METRIC EQUIV. (mm)
	8 THS	16 THS	32 NDS	64 THS		
				1	0.015625	0.396875
			1	2	0.031250	0.793750
					0.039370	1.000000
				3	0.046875	1.190625
		1	2	4	0.062500	1.587500
				5	0.078125	1.984375
					0.078740	2.000000
			3	6	0.093750	2.381250
				7	0.109375	2.778125
					0.118110	3.000000
1/8	1	2	4	8	0.125000	3.175000
				9	0.140625	3.571875
			5	10	0.156250	3.968750
					0.157480	4.000000
				11	0.171875	4.365625
		3	6	12	0.187500	4.762500
					0.196850	5.000000
				13	0.203125	5.159375
			7	14	0.218750	5.556250
				15	0.234375	5.953125
					0.236220	6.000000
1/4	2	4	8	16	0.250000	6.350000
				17	0.265625	6.746875
					0.275591	7.000000
			9	18	0.281250	7.143750
				19	0.296875	7.540625
		5	10	20	0.312500	7.937500
					0.314961	8.000000
				21	0.328125	8.334375
			11	22	0.343750	8.731250
					0.354331	9.000000
				23	0.359375	9.128125
3/8	3	6	12	24	0.375000	9.525000
				25	0.390625	9.921875
					0.393701	10.000000
			13	26	0.406250	10.318750
				27	0.421875	10.715625
					0.433071	11.000000
		7	14	28	0.437500	11.112500
				29	0.453125	11.509375
			15	30	0.468750	11.906250
					0.472441	12.000000
				31	0.484375	12.303125
1/2	4	8	16	32	0.500000	12.700000

	FRACTIONS OF ONE INCH				DECIMAL EQUIV. (IN)	METRIC EQUIV. (mm)
	8 THS	16 THS	32 NDS	64 THS		
				33	0.515625	13.096875
					0.511811	13.000000
			17	34	0.531250	13.493750
				35	0.546875	13.890625
					0.551181	14.000000
		9	18	36	0.562500	14.287500
				37	0.578125	14.684375
					0.590551	15.000000
			19	38	0.593750	15.081250
				39	0.609375	15.478125
5/8	5	10	20	40	0.625000	15.875000
					0.629921	16.000000
				41	0.640625	16.271875
			21	42	0.656250	16.668750
					0.669291	17.000000
				43	0.671875	17.065625
		11	22	44	0.687500	17.462500
				45	0.703125	17.859375
					0.708661	18.000000
			23	46	0.718750	18.256250
				47	0.734375	18.653125
					0.748031	19.000000
3/4	6	12	24	48	0.750000	19.050000
				49	0.765625	19.446875
			25	50	0.781250	19.843750
					0.787402	20.000000
				51	0.796875	20.240625
		13	26	52	0.812500	20.637500
					0.826772	21.000000
				53	0.828125	21.034375
			27	54	0.843750	21.431250
				55	0.859375	21.828125
					0.866142	22.000000
7/8	7	14	28	56	0.875000	22.225000
				57	0.890625	22.621875
					0.905512	23.000000
			29	58	0.906250	23.018750
				59	0.921875	23.415625
		15	30	60	0.937500	23.812500
					0.944882	24.000000
				61	0.953125	24.209375
			31	62	0.968750	24.606250
					0.984252	25.000000
				63	0.984375	25.003125
1	8	16	32	64	1.000000	25.400000

California

1959 East Cashdan Street, Rancho Dominguez, CA 90220
 (310) 609-1811 • (800) 326-0006 • FAX: (310) 609-1862
 E-Mail: salesrd@std-wire.com

Arizona

3120 West Thomas Road, Bldg. #801, Phoenix, AZ 85017
 (602) 269-2501 • (800) 325-6478 • FAX: (602) 278-7134
 E-Mail: salesphx@std-wire.com



CONVERSION TABLE OF TEMPERATURES

Locate temperature to be converted in center column -- read Centigrade (Celsius) equivalents to left, Fahrenheit equivalents to right.

°C	°C or °F	°F
-73.3	-100	-148.0
-67.8	-90	-130.0
-62.2	-80	-112.0
-56.7	-70	-94.0
-51.1	-60	-76.0
-45.6	-50	-58.0
-40.0	-40	-40.0
-34.4	-30	-22.0
-28.9	-20	-4.0
-23.3	-10	14.0
-17.8	0	32.0
-17.2	1	33.8
-16.7	2	35.6
-16.1	3	37.4
-15.6	4	39.2
-15.0	5	41.0
-14.4	6	42.8
-13.9	7	44.6
-13.3	8	46.4
-12.8	9	48.2
-12.2	10	50.0
-11.7	11	51.8
-11.1	12	53.6
-10.6	13	55.4
-10.0	14	57.2
-9.4	15	59.0
-8.9	16	60.8
-8.3	17	62.6
-7.8	18	64.4
-7.2	19	66.2
-6.7	20	68.0
-6.1	21	69.8
-5.6	22	71.6
-5.0	23	73.4
-4.4	24	75.2
-3.9	25	77.0
-3.3	26	78.8
-2.8	27	80.6
-2.2	28	82.4
-1.7	29	84.2
-1.1	30	86.0

°C	°C or °F	°F
-0.6	31	87.8
0.0	32	89.6
0.6	33	91.4
1.1	34	93.2
1.7	35	95.0
2.2	36	96.8
2.8	37	98.6
3.3	38	100.4
3.9	39	102.2
4.4	40	104.0
5.0	41	105.8
5.6	42	107.6
6.1	43	109.4
6.7	44	111.2
7.2	45	113.0
7.8	46	114.8
8.3	47	116.6
8.9	48	118.4
9.4	49	120.2
10.0	50	122.0
10.6	51	123.8
11.1	52	125.6
11.7	53	127.4
12.2	54	129.2
12.8	55	131.0
13.3	56	132.8
13.9	57	134.6
14.4	58	136.4
15.0	59	138.2
15.6	60	140.0
16.1	61	141.8
16.7	62	143.6
17.2	63	145.4
17.8	64	147.2
18.3	65	149.0
18.9	66	150.8
19.4	67	152.6
20.0	68	154.4
20.6	69	156.2
21.1	70	158.0
21.7	71	159.8
22.2	72	161.6

°C	°C or °F	°F
22.8	73	163.4
23.3	74	165.2
23.9	75	167.0
24.4	76	168.8
25.0	77	170.6
25.6	78	172.4
26.1	79	174.2
26.7	80	176.0
27.2	81	177.8
27.8	82	179.6
28.3	83	181.4
28.9	84	183.2
29.4	85	185.0
30.0	86	186.8
30.6	87	188.6
31.1	88	190.4
31.7	89	192.2
32.2	90	194.0
32.8	91	195.8
33.3	92	197.6
33.9	93	199.4
34.4	94	201.2
35.0	95	203.0
35.6	96	204.8
36.1	97	206.6
36.7	98	208.4
37.2	99	210.2
37.8	100	212.0
38.3	101	213.8
38.9	102	215.6
39.4	103	217.4
40.0	104	219.2
40.6	105	221.0
41.1	106	222.8
41.7	107	224.6
42.2	108	226.4
42.8	109	228.2
43.3	110	230.0
43.9	111	231.8
44.4	112	233.6
45.0	113	235.4
45.6	114	237.2

°C	°C or °F	°F
46.1	115	239.0
46.7	116	240.8
47.2	117	242.6
47.8	118	244.4
48.3	119	246.2
48.9	120	248.0
49.4	121	249.8
50.0	122	251.6
50.6	123	253.4
51.1	124	255.2
51.7	125	257.0
52.2	126	258.8
52.8	127	260.6
53.3	128	262.4
53.9	129	264.2
54.4	130	266.0
55.0	131	267.8
55.6	132	269.6
56.1	133	271.4
56.7	134	273.2
57.2	135	275.0
57.8	136	276.8
58.3	137	278.6
58.9	138	280.4
59.4	139	282.2
60.0	140	284.0
60.6	141	285.8
61.1	142	287.6
61.7	143	289.4
62.2	144	291.2
62.8	145	293.0
63.3	146	294.8
63.9	147	296.6
64.4	148	298.4
65.0	149	300.2
65.6	150	302.0
66.1	151	303.8
66.7	152	305.6
67.2	153	307.4
67.8	154	309.2
68.3	155	311.0
68.9	156	312.8

California

1959 East Cashdan Street, Rancho Dominguez, CA 90220
(310) 609-1811 • (800) 326-0006 • FAX: (310) 609-1862
E-Mail: salesrd@std-wire.com

Arizona

3120 West Thomas Road, Bldg. #801, Phoenix, AZ 85017
(602) 269-2501 • (800) 325-6478 • FAX: (602) 278-7134
E-Mail: salesphx@std-wire.com



Standard Wire & Cable Co.

CONVERSION TABLE OF TEMPERATURES

Locate temperature to be converted in center column -- read Centigrade (Celsius) equivalents to left, Fahrenheit equivalents to right.

°C	°C or °F	°F
69.4	157	314.6
70.0	158	316.4
70.6	159	318.2
71.1	160	320.0
71.7	161	321.8
72.2	162	323.6
72.8	163	325.4
73.3	164	327.2
73.9	165	329.0
74.4	166	330.8
75.0	167	332.6
75.6	168	334.4
76.1	169	336.2
76.7	170	338.0
77.2	171	339.8
77.8	172	341.6
78.3	173	343.4
78.9	174	345.2
79.4	175	347.0
80.0	176	348.8
80.6	177	350.6
81.1	178	352.4
81.7	179	354.2
82.2	180	356.0
82.8	181	357.8
83.3	182	359.6
83.9	183	361.4
84.4	184	363.2
85.0	185	365.0
85.6	186	366.8
86.1	187	368.6
86.7	188	370.4
87.2	189	372.2
87.8	190	374.0
88.3	191	375.8
88.9	192	377.6
89.4	193	379.4
90.0	194	381.2
90.6	195	383.0
91.1	196	384.8
91.7	197	386.6
92.2	198	388.4

°C	°C or °F	°F
92.8	199	390.2
93.3	200	392.0
93.9	201	393.8
94.4	202	395.6
95.0	203	397.4
95.6	204	399.2
96.1	205	401.0
96.7	206	402.8
97.2	207	404.6
97.8	208	406.4
98.3	209	408.2
98.9	210	410.0
99.4	211	411.8
100.0	212	413.6
100.6	213	415.4
101.1	214	417.2
101.7	215	419.0
102.2	216	420.8
102.8	217	422.6
103.3	218	424.4
103.9	219	426.2
104.4	220	428.0
105.0	221	429.8
105.6	222	431.6
106.1	223	433.4
106.7	224	435.2
107.2	225	437.0
107.8	226	438.8
108.3	227	440.6
108.9	228	442.4
109.4	229	444.2
110.0	230	446.0
110.6	231	447.8
111.1	232	449.6
111.7	233	451.4
112.2	234	453.2
112.8	235	455.0
113.3	236	456.8
113.9	237	458.6
114.4	238	460.4
115.0	239	462.2
115.6	240	464.0

°C	°C or °F	°F
116.1	241	465.8
116.7	242	467.6
117.2	243	469.4
117.8	244	471.2
118.3	245	473.0
118.9	246	474.8
119.4	247	476.6
120.0	248	478.4
120.6	249	480.2
121.1	250	482.0
121.7	251	483.8
122.2	252	485.6
122.8	253	487.4
123.3	254	489.2
123.9	255	491.0
124.4	256	492.8
125.0	257	494.6
125.6	258	496.4
126.1	259	498.2
126.7	260	500.0

California

1959 East Cashdan Street, Rancho Dominguez, CA 90220
(310) 609-1811 • (800) 326-0006 • FAX: (310) 609-1862
E-Mail: salesrd@std-wire.com

Arizona

3120 West Thomas Road, Bldg. #801, Phoenix, AZ 85017
(602) 269-2501 • (800) 325-6478 • FAX: (602) 278-7134
E-Mail: salesphx@std-wire.com



Standard Wire & Cable Co.

WIRE DATA - SOLID BARE COPPER

AWG	DIAMETER		CROSS SECTIONAL AREA			WEIGHT	
	(in)	(mm)	(sq in)	(sq mm)	(circular mils)	(lbs / 1000 ft)	(kgs / 1000 m)
44	0.0020	0.0502	0.00000307	0.0000198	3.91	0.01184	0.01762
43	0.0022	0.0564	0.00000387	0.0000250	4.93	0.01493	0.02222
42	0.0025	0.0633	0.00000488	0.0000315	6.22	0.01882	0.02801
41	0.0028	0.0711	0.00000616	0.0000397	7.84	0.02374	0.03533
40	0.0031	0.0799	0.00000777	0.0000501	9.89	0.02993	0.04454
39	0.0035	0.0897	0.00000979	0.0000632	12.5	0.03774	0.05616
38	0.0040	0.1007	0.00001235	0.0000797	15.7	0.04759	0.07082
37	0.0045	0.1131	0.00001557	0.000100	19.8	0.06001	0.08931
36	0.0050	0.1270	0.00001963	0.000127	25.0	0.07567	0.1126
35	0.0056	0.1426	0.00002476	0.000160	31.5	0.09542	0.1420
34	0.0063	0.1601	0.00003122	0.000201	39.8	0.1203	0.1790
33	0.0071	0.1798	0.00003937	0.000254	50.1	0.1517	0.2258
32	0.0080	0.2019	0.00004964	0.000320	63.2	0.1913	0.2847
31	0.0089	0.2268	0.0000626	0.000404	79.7	0.2413	0.3591
30	0.0100	0.2546	0.0000789	0.000509	101	0.3042	0.4527
29	0.0113	0.2859	0.0000995	0.000642	127	0.3836	0.5709
28	0.0126	0.3211	0.0001255	0.000810	160	0.4837	0.7198
27	0.0142	0.3606	0.0001583	0.00102	202	0.6100	0.9078
26	0.0159	0.4049	0.0001996	0.00129	254	0.7692	1.145
25	0.0179	0.4547	0.0002517	0.00162	320	0.9699	1.443
24	0.0201	0.5106	0.0003173	0.00205	404	1.223	1.820
23	0.0226	0.5733	0.0004001	0.00258	509	1.542	2.295
22	0.0253	0.6438	0.0005046	0.00326	642	1.945	2.895
21	0.0285	0.7229	0.0006363	0.00411	810	2.452	3.649
20	0.0320	0.8118	0.0008023	0.00518	1,022	3.092	4.601
19	0.0359	0.9116	0.001012	0.00653	1,288	3.899	5.802
18	0.0403	1.0237	0.001276	0.00823	1,624	4.917	7.317
17	0.0453	1.1495	0.001609	0.0104	2,048	6.200	9.227
16	0.0508	1.2908	0.002028	0.0131	2,583	7.818	11.63
15	0.0571	1.4495	0.002558	0.0165	3,257	9.858	14.67
14	0.0641	1.6277	0.003225	0.0208	4,107	12.43	18.50
13	0.0720	1.8278	0.004067	0.0262	5,178	15.68	23.33
12	0.0808	2.0525	0.005129	0.0331	6,530	19.77	29.42
11	0.0907	2.3048	0.006467	0.0417	8,234	24.92	37.09
10	0.1019	2.5882	0.008155	0.0526	10,383	31.43	46.77
9	0.1144	2.9064	0.01028	0.0663	13,093	39.63	58.98
8	0.1285	3.2636	0.01297	0.0837	16,510	49.97	74.36
7	0.1443	3.6649	0.01635	0.105	20,818	63.02	93.79
6	0.1620	4.1154	0.02062	0.133	26,251	79.46	118.3
5	0.1819	4.6213	0.02600	0.168	33,102	100.2	149.1
4	0.2043	5.1894	0.03278	0.211	41,741	126.4	188.1
3	0.2294	5.8273	0.04134	0.267	52,635	159.3	237.1
2	0.2576	6.5437	0.05213	0.336	66,371	200.9	299.0
1	0.2893	7.3481	0.06573	0.424	83,693	253.3	377.0
1/0	0.3249	8.2515	0.08289	0.535	105,535	319.5	475.5
2/0	0.3648	9.2658	0.1045	0.674	133,077	402.8	599.4
3/0	0.4096	10.4049	0.1318	0.850	167,806	507.9	755.8
4/0	0.4600	11.6840	0.1662	1.07	211,600	640.5	953.2

California

1959 East Cashdan Street, Rancho Dominguez, CA 90220
 (310) 609-1811 • (800) 326-0006 • FAX: (310) 609-1862
 E-Mail: salesrd@std-wire.com

Arizona

3120 West Thomas Road, Bldg. #801, Phoenix, AZ 85017
 (602) 269-2501 • (800) 325-6478 • FAX: (602) 278-7134
 E-Mail: salesphx@std-wire.com



Standard Wire & Cable Co.

WIRE DATA - SOLID BARE COPPER

AWG	SOFT OR ANNEALED						AWG	HARD DRAWN					
	TENSILE STRENGTH MAXIMUM		BREAKING STRENGTH MINIMUM		MAXIMUM DC RESISTANCE @ 20°C (68° F)			TENSILE STRENGTH MAXIMUM		BREAKING STRENGTH MINIMUM		MAXIMUM DC RESISTANCE @ 20°C (68° F)	
	(lbs / sq in)	(kgs / sq mm)	(lbs)	(kgs)	(ohms / 1000 ft)	(ohms / 1000 m)		(lbs / sq in)	(kgs / sq mm)	(lbs)	(kgs)	(ohms / 1000 ft)	(ohms / 1000 m)
44	40,000	59,520	0.1229	0.05575	2,652	8,701	44	72,000	107,136	0.2212	0.1003	2,758	9,049
43	40,000	59,520	0.1549	0.07026	2,103	6,900	43	72,000	107,136	0.2789	0.1265	2,187	7,176
42	40,000	59,520	0.1954	0.08863	1,668	5,473	42	72,000	107,136	0.3517	0.1595	1,734	5,689
41	40,000	59,520	0.2464	0.1118	1,323	4,341	41	72,000	107,136	0.4434	0.2011	1,375	4,511
40	40,000	59,520	0.3106	0.1409	1,049	3,442	40	72,000	107,136	0.5592	0.2537	1,091	3,580
39	40,000	59,520	0.3917	0.1777	831.8	2,729	39	71,800	106,838	0.7031	0.3189	865.0	2,838
38	40,000	59,520	0.4939	0.2240	659.6	2,164	38	71,500	106,392	0.8829	0.4005	686.0	2,251
37	40,000	59,520	0.6228	0.2825	523.1	1,716	37	71,300	106,094	1.1100	0.5035	544.0	1,785
36	40,000	59,520	0.7854	0.3563	414.8	1,361	36	71,100	105,797	1.3960	0.6332	431.4	1,415
35	40,000	59,520	0.9904	0.4492	329.0	1,079	35	70,900	105,499	1.7550	0.7961	342.1	1,122
34	40,000	59,520	1.249	0.5665	260.9	856.0	34	70,600	105,053	2.204	0.9997	271.3	890.1
33	40,000	59,520	1.575	0.7144	206.9	678.8	33	70,400	104,755	2.772	1.257	215.2	706.1
32	40,000	59,520	1.986	0.9008	164.1	538.4	32	70,200	104,458	3.485	1.581	170.6	559.7
31	40,000	59,520	2.504	1.136	130.1	426.9	31	69,900	104,458	4.376	1.985	135.3	443.9
30	40,000	59,520	3.157	1.432	103.2	338.6	30	69,700	104,011	5.502	2.496	107.3	352.1
29	40,000	59,520	3.981	1.806	81.84	268.5	29	69,400	103,714	6.908	3.133	85.10	279.2
28	40,000	59,520	5.020	2.277	64.90	212.9	28	69,300	103,267	8.698	3.945	67.49	221.4
27	40,000	59,520	6.331	2.872	51.47	168.9	27	69,000	103,118	10.92	4.953	53.52	175.6
26	40,000	59,520	7.983	3.621	40.81	133.9	26	68,800	102,672	13.73	6.228	42.44	139.2
25	40,000	59,520	10.07	4.568	32.37	106.2	25	68,600	102,374	17.26	7.829	33.66	110.4
24	40,000	59,520	12.69	5.756	25.67	84.22	24	68,300	102,077	21.67	9.829	26.69	87.57
23	38,500	57,288	15.41	6.990	20.36	66.80	23	68,100	101,630	27.25	12.36	21.17	69.46
22	38,500	57,288	19.43	8.813	16.14	52.96	22	67,900	101,333	34.26	15.54	16.79	55.09
21	38,500	57,288	24.50	11.11	12.80	42.00	21	67,700	101,035	43.07	19.54	13.31	43.67
20	38,500	57,288	30.89	14.01	10.15	33.30	20	67,400	100,738	54.08	24.53	10.56	34.65
19	38,500	57,288	38.95	17.67	8.051	26.42	19	67,200	100,291	67.99	30.84	8.373	27.47
18	38,500	57,288	49.12	22.28	6.385	20.95	18	67,000	99,994	85.47	38.77	6.640	21.79
17	38,500	57,288	61.93	28.09	5.064	16.61	17	66,800	99,696	107.5	48.76	5.266	17.28
16	38,500	57,288	78.10	35.43	4.016	13.18	16	66,600	99,398	135.1	61.28	4.176	13.70
15	38,500	57,288	98.48	44.67	3.184	10.45	15	66,400	99,101	169.8	77.02	3.312	10.87
14	38,500	57,288	124.2	56.34	2.525	8.285	14	66,200	98,803	213.5	96.84	2.626	8.616
13	38,500	57,288	156.6	71.03	2.003	6.572	13	65,900	98,506	268.0	121.6	2.083	6.834
12	38,500	57,288	197.5	89.59	1.588	5.210	12	65,700	98,059	336.9	152.8	1.652	5.420
11	38,500	57,288	249.0	112.9	1.260	4.134	11	65,400	97,762	422.9	191.8	1.310	4.298
10	38,500	57,288	314.0	142.4	0.9989	3.277	10	64,900	97,315	529.2	240.0	1.039	3.409
9	37,000	55,056	380.5	172.6	0.7921	2.599	9	64,300	96,571	661.2	299.9	0.8238	2.703
8	37,000	55,056	479.8	217.6	0.6282	2.061	8	63,700	95,678	826.0	374.7	0.6533	2.143
7	37,000	55,056	605.0	274.4	0.4982	1.635	7	63,000	94,786	1,030	467.2	0.5181	1.700
6	37,000	55,056	762.9	346.0	0.3951	1.296	6	62,100	93,744	1,280	580.6	0.4108	1.348
5	37,000	55,056	961.9	436.3	0.3133	1.028	5	61,200	92,405	1,591	721.7	0.3258	1.069
4	37,000	55,056	1,213	550.2	0.2485	0.8153	4	60,100	91,066	1,970	893.6	0.2584	0.8478
3	37,000	55,056	1,530	694.0	0.1970	0.6464	3	59,000	89,429	2,439	1,106	0.2049	0.6723
2	37,000	55,056	1,929	875.0	0.1563	0.5128	2	57,600	87,792	3,003	1,362	0.1625	0.5332
1	37,000	55,056	2,432	1,103	0.1239	0.4065	1	56,100	85,709	3,688	1,673	0.1289	0.4229
1/0	36,000	53,568	2,984	1,354	0.09827	0.3224	1/0	54,500	83,477	4,517	2,049	0.10110	0.3317
2/0	36,000	53,568	3,763	1,707	0.07793	0.2557	2/0	52,800	81,096	5,519	2,503	0.08021	0.2632
3/0	36,000	53,568	4,745	2,152	0.06180	0.2028	3/0	51,000	78,566	6,722	3,049	0.06361	0.2087
4/0	36,000	53,568	5,983	2,714	0.04901	0.1608	4/0	49,000	75,888	8,143	3,694	0.05045	0.1655

California

1959 East Cashdan Street, Rancho Dominguez, CA 90220
 (310) 609-1811 • (800) 326-0006 • FAX: (310) 609-1862
 E-Mail: salesrd@std-wire.com

Arizona

3120 West Thomas Road, Bldg. #801, Phoenix, AZ 85017
 (602) 269-2501 • (800) 325-6478 • FAX: (602) 278-7134
 E-Mail: salesphx@std-wire.com



Standard Wire & Cable Co.

WIRE DATA - STRANDED TINNED COPPER

AWG	STRAND- ING	NOMINAL O.D. OF STRAND		APPROXIMATE O.D.		CROSS SECTIONAL AREA			WEIGHT	
		(in)	(mm)	(in)	(mm)	(sq in)	(sq mm)	(circular mils)	(lbs / 1000 ft)	(kgs / 1000 m)
36	7/44	0.0020	0.0508	0.006	0.152	0.00002199	0.01419	28.00	0.085	0.126
34	7/42	0.0025	0.0635	0.0075	0.191	0.00003436	0.02217	43.75	0.132	0.196
32	7/40	0.0031	0.0787	0.008	0.203	0.00005283	0.03405	67.27	0.204	0.304
32	19/44	0.0020	0.0508	0.009	0.229	0.00005969	0.03851	76.00	0.230	0.342
30	7/38	0.0040	0.1016	0.012	0.305	0.00008796	0.05675	112.00	0.339	0.504
30	19/42	0.0025	0.0635	0.012	0.305	0.00009327	0.06017	118.75	0.359	0.534
28	7/36	0.0050	0.1270	0.015	0.381	0.0001374	0.08867	175.00	0.530	0.789
28	19/40	0.0031	0.0787	0.016	0.406	0.0001434	0.09243	182.59	0.553	0.823
27	7/35	0.0056	0.1422	0.018	0.457	0.0001724	0.1112	219.52	0.664	0.988
26	7/34	0.0063	0.1600	0.019	0.483	0.0002182	0.1407	277.83	0.841	1.25
26	10/36	0.0050	0.1270	0.021	0.533	0.0001963	0.1267	250.00	0.757	1.13
26	19/38	0.0040	0.1016	0.020	0.508	0.0002388	0.1540	304.00	0.920	1.37
24	7/32	0.0080	0.2032	0.024	0.610	0.0003519	0.2270	448.00	1.36	2.02
24	10/34	0.0063	0.1600	0.023	0.584	0.0003117	0.2011	396.90	1.20	1.79
24	19/36	0.0050	0.1270	0.024	0.610	0.0003731	0.2407	475.00	1.44	2.14
24	41/40	0.0031	0.0787	0.023	0.584	0.0003095	0.1994	394.01	1.19	1.77
22	7/30	0.0100	0.2540	0.030	0.762	0.0005498	0.3547	700.00	2.12	3.15
22	19/34	0.0063	0.1600	0.031	0.787	0.0005923	0.3820	754.11	2.28	3.39
22	26/36	0.0050	0.1270	0.030	0.762	0.0005105	0.3294	650.00	1.97	2.93
20	10/30	0.0100	0.2540	0.036	0.914	0.0007854	0.5067	1,000.0	3.03	4.51
20	19/32	0.0080	0.2032	0.037	0.940	0.0009550	0.6162	1,216.0	3.68	5.48
20	26/34	0.0063	0.1600	0.036	0.914	0.0008105	0.5228	1,031.9	3.12	4.64
20	41/36	0.0050	0.1270	0.036	0.914	0.0008050	0.5194	1,025.0	3.10	4.61
18	7/26	0.0159	0.4039	0.048	1.219	0.001390	0.8969	1,769.7	5.36	7.98
18	16/30	0.0100	0.2540	0.047	1.194	0.001257	0.8107	1,600.0	4.84	7.20
18	19/30	0.0100	0.2540	0.049	1.245	0.001492	0.9627	1,900.0	5.75	8.56
18	41/34	0.0063	0.1600	0.047	1.194	0.001278	0.8244	1,627.3	4.93	7.34
18	65/36	0.0050	0.1270	0.047	1.194	0.001276	0.8234	1,625.0	4.92	7.32
16	7/24	0.0201	0.5105	0.060	1.524	0.002221	1.433	2,828.1	8.56	12.7
16	19/29	0.0113	0.2870	0.058	1.473	0.001905	1.229	2,426.1	7.34	10.9
16	26/30	0.0100	0.2540	0.059	1.499	0.002042	1.317	2,600.0	7.87	11.7
16	65/34	0.0063	0.1600	0.059	1.499	0.002026	1.307	2,579.9	7.81	11.6
16	105/36	0.0050	0.1270	0.059	1.499	0.002062	1.330	2,625.0	7.95	11.8
14	7/22	0.0253	0.6426	0.073	1.854	0.003519	2.270	4,480.6	13.6	20.2
14	19/27	0.0142	0.3607	0.073	1.854	0.003009	1.941	3,831.2	11.6	17.3
14	41/30	0.0100	0.2540	0.073	1.854	0.003220	2.078	4,100.0	12.4	18.5
14	105/34	0.0063	0.1600	0.073	1.854	0.003273	2.111	4,167.5	12.6	18.7
12	7/20	0.0320	0.8128	0.096	2.438	0.005630	3.632	7,168.0	21.7	32.3
12	19/25	0.0179	0.4547	0.093	2.362	0.004781	3.085	6,087.8	18.4	27.4
12	65/30	0.0100	0.2540	0.095	2.413	0.005105	3.294	6,500.0	19.7	29.3
12	165/34	0.0063	0.1600	0.095	2.413	0.005143	3.318	6,548.9	19.8	29.5

California

1959 East Cashdan Street, Rancho Dominguez, CA 90220
 (310) 609-1811 • (800) 326-0006 • FAX: (310) 609-1862
 E-Mail: salesrd@std-wire.com

Arizona

3120 West Thomas Road, Bldg. #801, Phoenix, AZ 85017
 (602) 269-2501 • (800) 325-6478 • FAX: (602) 278-7134
 E-Mail: salesphx@std-wire.com



Standard Wire & Cable Co.

WIRE DATA - STRANDED TINNED COPPER

AWG	STRAND- ING	NOMINAL O.D. OF STRAND		APPROXIMATE O.D.		CROSS SECTIONAL AREA			WEIGHT	
		(in)	(mm)	(in)	(mm)	(sq in)	(sq mm)	(circular mils)	(lbs / 1000 ft)	(kgs / 1000 m)
10	37/26	0.0159	0.4039	0.115	2.921	0.007347	4.741	9,354.0	28.3	42.1
10	49/27	0.0142	0.3607	0.116	2.946	0.007760	5.007	9,880.4	29.9	44.5
10	105/30	0.0100	0.2540	0.116	2.946	0.008247	5.320	10,500	31.8	47.3
8	49/25	0.0179	0.4547	0.147	3.734	0.01233	7.957	15,700	47.5	70.7
8	133/29	0.0113	0.2870	0.147	3.734	0.01334	8.604	16,983	51.4	76.5
8	655/36	0.0050	0.1270	0.147	3.734	0.01286	8.297	16,375	49.6	73.8
6	133/27	0.0142	0.3607	0.184	4.674	0.02106	13.59	26,818	81.2	121
6	259/30	0.0100	0.2540	0.184	4.674	0.02034	13.12	25,900	78.4	117
6	1050/36	0.0050	0.1270	0.184	4.674	0.02062	13.30	26,250	79.5	118
4	133/25	0.0179	0.4547	0.232	5.893	0.03347	21.60	42,615	129	192
4	259/27	0.0142	0.3607	0.232	5.893	0.04102	26.47	52,225	158	235
4	1666/36	0.0050	0.1270	0.232	5.893	0.03271	21.10	41,650	126	187
2	133/23	0.0226	0.5740	0.292	7.417	0.05335	34.42	67,931	206	307
2	259/26	0.0159	0.4039	0.292	7.417	0.05143	33.18	65,478	198	295
2	665/30	0.0100	0.2540	0.292	7.417	0.05223	33.70	66,500	201	299
2	2646/36	0.0050	0.1270	0.292	7.417	0.05195	33.52	66,150	200	298
1	133/22	0.0253	0.6426	0.328	8.331	0.06686	43.13	85,132	258	384
1	259/25	0.0179	0.4547	0.328	8.331	0.06518	42.06	82,986	251	373
1	817/30	0.0100	0.2540	0.328	8.331	0.06417	41.40	81,700	247	368
1	2109/34	0.0063	0.1600	0.328	8.331	0.06574	42.40	83,706	253	376
1/0	133/21	0.0285	0.7239	0.368	9.347	0.08485	54.74	108,029	327	487
1/0	259/24	0.0201	0.5105	0.368	9.347	0.08218	53.01	104,639	317	472
1/0	1045/30	0.0100	0.2540	0.368	9.347	0.08207	52.95	104,500	316	470
1/0	2660/34	0.0063	0.1600	0.368	9.347	0.08292	53.48	105,575	320	476
1/0	4214/36	0.0050	0.1270	0.368	9.347	0.08274	53.38	105,350	319	475
2/0	133/20	0.0320	0.8128	0.414	10.516	0.1070	69.01	136,192	412	613
2/0	259/23	0.0226	0.5740	0.414	10.516	0.1039	67.02	132,287	400	595
2/0	1330/30	0.0100	0.2540	0.414	10.516	0.1045	67.39	133,000	403	600
2/0	3325/34	0.0063	0.1600	0.414	10.516	0.1036	66.85	131,969	399	594
2/0	5292/36	0.0050	0.1270	0.414	10.516	0.1039	67.04	132,300	400	595
3/0	259/22	0.0253	0.6426	0.464	11.786	0.1302	84.00	165,783	502	747
3/0	427/24	0.0201	0.5105	0.464	11.786	0.1355	87.40	172,512	522	777
3/0	1661/30	0.0100	0.2540	0.464	11.786	0.1305	84.16	166,100	503	748
3/0	4256/34	0.0063	0.1600	0.464	11.786	0.1327	85.57	168,921	511	760
3/0	6713/36	0.0050	0.1270	0.464	11.786	0.1318	85.04	167,825	508	756
4/0	259/21	0.0285	0.7239	0.522	13.259	0.1652	106.6	210,373	637	948
4/0	427/23	0.0226	0.5740	0.522	13.259	0.1713	110.5	218,095	660	982
4/0	2104/30	0.0100	0.2540	0.522	13.259	0.1652	106.6	210,400	637	948
4/0	5320/34	0.0063	0.1600	0.522	13.259	0.1658	107.0	211,151	639	951
4/0	8512/36	0.0050	0.1270	0.522	13.259	0.1671	107.8	212,800	644	958

California

1959 East Cashdan Street, Rancho Dominguez, CA 90220
 (310) 609-1811 • (800) 326-0006 • FAX: (310) 609-1862
 E-Mail: salesrd@std-wire.com

Arizona

3120 West Thomas Road, Bldg. #801, Phoenix, AZ 85017
 (602) 269-2501 • (800) 325-6478 • FAX: (602) 278-7134
 E-Mail: salesphx@std-wire.com



WIRE DATA - STRANDED TINNED COPPER

AWG	STRAND-ING	DC RESISTANCE @ 20°C	
		(ohms / 1000 ft)	(ohms / 1000 m)
36	7/44	401.6	1318
34	7/42	252.6	828.7
32	7/40	158.8	521.0
32	19/44	150.9	495.1
30	7/38	99.90	327.8
30	19/42	94.93	311.5
28	7/36	62.82	206.1
28	19/40	59.70	195.9
27	7/35	49.82	163.5
26	7/34	39.51	129.6
26	10/36	43.98	144.3
26	19/38	37.55	123.2
24	7/32	24.85	81.53
24	10/34	27.66	90.75
24	19/36	23.61	77.46
24	41/40	28.84	94.62
22	7/30	15.63	51.28
22	19/34	14.85	48.72
22	26/36	17.62	57.81
20	10/30	10.94	35.89
20	19/32	9.340	30.64
20	26/34	11.08	36.35
20	41/36	11.41	37.43
18	7/26	6.181	20.28
18	16/30	6.908	22.66
18	19/30	5.874	19.27
18	41/34	7.173	23.53
18	65/36	7.194	23.60
16	7/24	3.887	12.75
16	19/29	4.658	15.28
16	26/30	4.384	14.38
16	65/34	4.524	14.84
16	105/36	4.453	14.61
14	7/22	2.445	8.022
14	19/27	2.930	9.613
14	41/30	2.837	9.308
14	105/34	2.801	9.190
12	7/20	1.538	5.046
12	19/25	1.842	6.043
12	65/30	1.789	5.869
12	165/34	1.799	5.902

AWG	STRAND-ING	DC RESISTANCE @ 20°C	
		(ohms / 1000 ft)	(ohms / 1000 m)
10	37/26	1.243	4.078
10	49/27	1.184	3.885
10	105/30	1.108	3.635
8	49/25	0.7446	2.443
8	133/29	0.7002	2.297
8	655/36	0.7207	2.365
6	133/27	0.4403	1.445
6	259/30	0.4534	1.488
6	1050/36	0.4496	1.475
4	133/25	0.2769	0.9085
4	259/27	0.2261	0.7418
4	1666/36	0.2834	0.9298
2	133/23	0.1742	0.5715
2	259/26	0.1793	0.5883
2	665/30	0.1766	0.5794
2	2646/36	0.1784	0.5853
1	133/22	0.1381	0.4531
1	259/25	0.1422	0.4665
1	817/30	0.1437	0.4715
1	2109/34	0.1408	0.4619
1/0	133/21	0.1095	0.3593
1/0	259/24	0.1128	0.3701
1/0	1045/30	0.1124	0.3688
1/0	2660/34	0.1116	0.3661
1/0	4214/36	0.1120	0.3675
2/0	133/20	0.08686	0.2850
2/0	259/23	0.08944	0.2934
2/0	1330/30	0.08829	0.2897
2/0	3325/34	0.08929	0.2929
2/0	5292/36	0.08920	0.2927
3/0	259/22	0.07093	0.2327
3/0	427/24	0.06841	0.2244
3/0	1661/30	0.07070	0.2320
3/0	4256/34	0.06976	0.2289
3/0	6713/36	0.07032	0.2307
4/0	259/21	0.05625	0.1845
4/0	427/23	0.05425	0.1780
4/0	2104/30	0.05581	0.1831
4/0	5320/34	0.05581	0.1831
4/0	8512/36	0.05546	0.1820

California

1959 East Cashdan Street, Rancho Dominguez, CA 90220
 (310) 609-1811 • (800) 326-0006 • FAX: (310) 609-1862
 E-Mail: salesrd@std-wire.com

Arizona

3120 West Thomas Road, Bldg. #801, Phoenix, AZ 85017
 (602) 269-2501 • (800) 325-6478 • FAX: (602) 278-7134
 E-Mail: salesphx@std-wire.com



Standard Wire & Cable Co.

Trademarks

The following is a list of trademarks referenced in this publication:

Alumel®	- Hoskins Mfg. Co.
Balco®	- Wilbur Driver Co.
Chromel®	- Hoskins Mfg. Co.
Copperweld®	- Copperweld Steel Company
Detecta-Duct®	- Standard Wire & Cable Co.
Flexoprene®	- Standard Wire & Cable Co.
H-Film®	- DuPont de Nemours Co.
Halar®	- Allied Chemical Co.
Hypalon®	- DuPont de Nemours Co.
Kapton®	- DuPont de Nemours Co.
Karma®	- Driver Harris Company
Kevlar®	- DuPont de Nemours Co.
Kynar®	- Pennwalt Corporation
Microminum®	- Standard Wire & Cable Co.
Mylar®	- DuPont de Nemours Co.
Neoprene®	- DuPont de Nemours Co.
Nicrome®	- Driver Harris Company
Nomex®	- DuPont de Nemours Co.
Okocord®	- Okonite Company
Okoprene®	- Okonite Company
Stanflex®	- Standard Wire & Cable Co.
Teflon®	- DuPont de Nemours Co.
Tefzel®	- DuPont de Nemours Co.
Velcro®	- Velcro Industries B.V.
Viton®	- DuPont Dow Elastomers.

California

1959 East Cashdan Street, Rancho Dominguez, CA 90220
(310) 609-1811 • (800) 326-0006 • FAX: (310) 609-1862
E-Mail: salesrd@std-wire.com

Arizona

3120 West Thomas Road, Bldg. #801, Phoenix, AZ 85017
(602) 269-2501 • (800) 325-6478 • FAX: (602) 278-7134
E-Mail: salesphx@std-wire.com



Standard Wire & Cable Co.

Index of Catalog Numbers

Catalog No.	Page No.	Catalog No.	Page No.	Catalog No.	Page No.	Catalog No.	Page No.
HHW-5	152	M9X505	193	M17/56 RG130	117	M17/130-00008	119
HHW-7	152	M9X506	193	M17/56 RG131	117	M17/130-00009	119
HHW-10	152	M9X507	193	M17/60 RG142	117	M17/130-00010	119
HHW-15	152	M9X508	193	M17/62 RG144	117	M17/130-00011	119
HHW-20	152	M9X509	193	M17/64 RG35	117	M17/131 RG403	119
HRSR-1	162	M9X510	193	M17/64 RG164	117	M17/132-00001	119
HRSR-2	162	M9X511	193	M17/65 RG165	117	M17/132 RG404	119
HRSR-3	162	M9X512	193	M17/65 RG166	117	M17/133 RG405	119
HRSR-4	162	M9X513	193	M17/67 RG177	117	M17/133-00001	119
HRSR-5	162	M9X514	193	M17/72 RG211	117	M17/133-00002	119
M9X001	187	M9X515	193	M17/73 RG212	117	M17/133-00003	119
M9X002	187	M9X516	193	M17/74 RG213	117	M17/133-00004	119
M9X003	187	M9X517	193	M17/74 RG215	117	M17/133-00005	119
M9X004	187	M9X518	193	M17/75 RG214	117	M17/133-00006	119
M9X005	191	M9X519	193	M17/75 RG365	117	M17/133-00007	119
M9X006	191	M9X600	188	M17/77 RG216	117	M17/133-00008	119
M9X007	191	M9X602	188	M17/78-00001	117	M17/133-00009	119
M9X008	191	M9X604	188	M17/78 RG217	117	M17/133-00010	119
M9X009	191	M9X606	188	M17/79 RG218	117	M17/133-00011	119
M9X010	191	M9X609	188	M17/79 RG219	117	M17/133-00012	119
M9X011	191	M9X610	189	M17/81-00001	117	M17/133-00013	119
M9X012	191	M9X612	189	M17/81-00002	117	M17/133-00014	119
M9X013	190	M9X614	189	M17/84 RG223	117	M17/133-00015	119
M9X014	190	M9X616	189	M17/86-00001	117	M17/133-00016	119
M9X015	190	M9X619	188	M17/86-00002	117	M17/133-00017	120
M9X016	190	M9X620	189	M17/87-00001	117	M17/134-00001	120
M9X017	190	M9X810	194	M17/90 RG71	118	M17/134-00002	120
M9X018	190	M9X811	194	M17/92 RG115	118	M17/134-00003	120
M9X019	190	M9X812	194	M17/92-00001	118	M17/134-00004	120
M9X020	190	M9X813	194	M17/93 RG178	118	M17/135-00001	120
M9X037	188	M9X814	194	M17/93-00001	118	M17/135-00002	120
M9X038	188	M9X815	194	M17/94 RG179	118	M17/135-00003	120
M9X039	188	M9X816	194	M17/95 RG180	118	M17/135-00004	120
M9X040	188	M9X817	194	M17/96 RG209	118	M17/135-00005	120
M9X042	188	M17/2 RG6	116	M17/97 RG210	118	M17/135-00006	120
M9X043	189	M17/6 RG11	116	M17/100 RG133	118	M17/136-00001	120
M9X044	189	M17/6 RG12	116	M17/109 RG301	118	M17/137-00001	120
M9X045	189	M17/15 RG22	116	M17/110 RG302	118	M17/138-00001	120
M9X046	189	M17/15 RG111	116	M17/111 RG303	118	M17/139-00001	120
M9X048	189	M17/16 RG23	116	M17/112 RG304	118	M17/140-00001	120
M9X058	192	M17/16 RG24	116	M17/113 RG316	118	M17/151-00001	120
M9X059	192	M17/19 RG25	116	M17/116 RG307	118	M17/151-00002	120
M9X060	192	M17/21 RG26	116	M17/119 RG174	118	M17/152-00001	120
M9X061	192	M17/22-00001	116	M17/124 RG328	118	M17/153-00001	120
M9X062	192	M17/22 RG27	116	M17/125 RG329	118	M17/154-00001	120
M9X063	193	M17/23 RG28	116	M17/126 RG391	118	M17/154-00002	120
M9X064	193	M17/24 RG34	116	M17/126 RG392	118	M17/155-00001	120
M9X065	193	M17/28 RG58	116	M17/127 RG393	118	M17/156-00001	120
M9X066	193	M17/29 RG59	116	M17/128 RG400	118	M17/157-00001	120
M9X067	193	M17/30 RG62	116	M17/129 RG401	118	M17/158-00001	120
M9X080	187	M17/31 RG63	116	M17/129-00001	118	M17/159-00001	120
M9X081	187	M17/31 RG79	116	M17/130 RG402	118	M17/160-00001	120
M9X082	190	M17/33 RG64	116	M17/130-00001	118	M17/161-00001	121
M9X083	191	M17/34 RG65	116	M17/130-00002	119	M17/161-00002	121
M9X500	193	M17/45 RG108	116	M17/130-00003	119	M17/162-00001	121
M9X501	193	M17/47 RG114	116	M17/130-00004	119	M17/163-00001	121
M9X502	193	M17/52 RG119	116	M17/130-00005	119	M17/164-00001	121
M9X503	193	M17/52 RG120	117	M17/130-00006	119	M17/164-00002	121
M9X504	193	M17/54 RG122	117	M17/130-00007	119	M17/165-00001	121

California

1959 East Cashdan Street, Rancho Dominguez, CA 90220
(310) 609-1811 • (800) 326-0006 • FAX: (310) 609-1862

E-Mail: salesrd@std-wire.com

Arizona

3120 West Thomas Road, Bldg. #801, Phoenix, AZ 85017
(602) 269-2501 • (800) 325-6478 • FAX: (602) 278-7134

E-Mail: salesphx@std-wire.com



Standard Wire & Cable Co.

Catalog No.	Page No.	Catalog No.	Page No.	Catalog No.	Page No.	Catalog No.	Page No.
M17/165-00002	121	M17/215-00001	123	M22759/22-24*	82	M22759/42-24*	85
M17/166-00001	121	M17/216-00001	124	M22759/22-26*	82	M22759/42-26*	85
M17/167-00001	121	M17/217-00001	124	M22759/22-28*	82	M22759/43-01*	86
M17/168-00001	121	M17/218-00001	124	M22759/23-20*	82	M22759/43-1*	86
M17/168-00002	121	M17/218-00002	124	M22759/23-22*	82	M22759/43-02*	86
M17/169-00001	121	M22759/9-8*	78	M22759/23-24*	82	M22759/43-2*	86
M17/170-00001	121	M22759/9-10*	78	M22759/23-26*	82	M22759/43-4*	86
M17/171-00001	121	M22759/9-12*	78	M22759/23-28*	82	M22759/43-6*	86
M17/172-00001	121	M22759/9-14*	78	M22759/32-12*	83	M22759/43-8*	86
M17/173-00001	121	M22759/9-16*	78	M22759/32-14*	83	M22759/43-10*	86
M17/174-00001	121	M22759/9-18*	78	M22759/32-16*	83	M22759/43-12*	86
M17/175-00001	121	M22759/9-20*	78	M22759/32-18*	83	M22759/43-14*	86
M17/176-00002	121	M22759/9-22*	78	M22759/32-20*	83	M22759/43-16*	86
M17/176-00003	121	M22759/9-24*	78	M22759/32-22*	83	M22759/43-18*	86
M17/177-00001	121	M22759/9-26*	78	M22759/32-24*	83	M22759/43-20*	86
M17/178-00001	121	M22759/9-28*	78	M22759/32-26*	83	M22759/43-22*	86
M17/179-00001	122	M22759/10-8*	78	M22759/32-28*	83	M22759/43-24*	86
M17/180-00001	122	M22759/10-10*	78	M22759/32-30*	83	M22759/43-26*	86
M17/181-00001	122	M22759/10-12*	78	M22759/33-20*	83	M22759/44-12*	86
M17/181-00002	122	M22759/10-14*	78	M22759/33-22*	83	M22759/44-14*	86
M17/182-00001	122	M22759/10-16*	78	M22759/33-24*	83	M22759/44-16*	86
M17/182-00002	122	M22759/10-18*	78	M22759/33-26*	83	M22759/44-18*	86
M17/183-00001	122	M22759/10-20*	78	M22759/33-28*	83	M22759/44-20*	86
M17/184-00001	122	M22759/10-22*	78	M22759/33-30*	83	M22759/44-22*	86
M17/185-00001	122	M22759/10-24*	78	M22759/34-1*	84	M22759/44-24*	86
M17/186-00001	122	M22759/10-26*	78	M22759/34-01*	84	M22759/44-26*	86
M17/187-00001	122	M22759/10-28*	78	M22759/34-2*	84	M22759/44-28*	86
M17/188-00001	122	M22759/11-8*	79	M22759/34-02*	84	M22759/45-12*	87
M17/189-00001	122	M22759/11-10*	79	M22759/34-4*	84	M22759/45-14*	87
M17/189-00002	122	M22759/11-12*	79	M22759/34-6*	84	M22759/45-16*	87
M17/190-00001	122	M22759/11-14*	79	M22759/34-8*	84	M22759/45-18*	87
M17/191-00001	122	M22759/11-16*	79	M22759/34-10*	84	M22759/45-20*	87
M17/192-00001	122	M22759/11-18*	79	M22759/34-12*	84	M22759/45-22*	87
M17/192-00002	122	M22759/11-20*	79	M22759/34-14*	84	M22759/45-24*	87
M17/193-00001	122	M22759/11-22*	79	M22759/34-16*	84	M22759/45-26*	87
M17/193-00002	122	M22759/11-24*	79	M22759/34-18*	84	M22759/45-28*	87
M17/194-00001	122	M22759/11-26*	79	M22759/34-20*	84	M22759/46-20*	87
M17/195-00001	122	M22759/11-28*	79	M22759/34-22*	84	M22759/46-22*	87
M17/196-00001	122	M22759/12-8*	79	M22759/34-24*	84	M22759/46-24*	87
M17/197-00001	122	M22759/12-10*	79	M22759/35-20*	84	M22759/46-26*	87
M17/198-00001	122	M22759/12-12*	79	M22759/35-22*	84	M22759/46-28*	87
M17/199-00001	122	M22759/12-14*	79	M22759/35-24*	84	M22759/80-10*	88
M17/200-00001	122	M22759/12-16*	79	M22759/35-26*	84	M22759/80-12*	88
M17/201-00001	123	M22759/12-18*	79	M22759/41-01*	85	M22759/80-14*	88
M17/201-00002	123	M22759/12-20*	79	M22759/41-1*	85	M22759/80-16*	88
M17/201-00003	123	M22759/12-22*	79	M22759/41-02*	85	M22759/80-18*	88
M17/202-00001	123	M22759/12-24*	79	M22759/41-2*	85	M22759/80-20*	88
M17/203-00001	123	M22759/12-26*	79	M22759/41-4*	85	M22759/80-22*	88
M17/205-00018	123	M22759/12-28*	79	M22759/41-6*	85	M22759/80-24*	88
M17/205-00050	123	M22759/20-20*	81	M22759/41-8*	85	M22759/80-26*	88
M17/206-00018	123	M22759/20-22*	81	M22759/41-10*	85	M22759/81-20*	88
M17/206-00030	123	M22759/20-24*	81	M22759/41-12*	85	M22759/81-22*	88
M17/208-00001	123	M22759/20-26*	81	M22759/41-14*	85	M22759/81-24*	88
M17/209-00001	123	M22759/20-28*	81	M22759/41-16*	85	M22759/81-26*	88
M17/209-00002	123	M22759/21-20*	81	M22759/41-18*	85	M22759/82-20*	89
M17/210-00001	123	M22759/21-22*	81	M22759/41-20*	85	M22759/82-22*	89
M17/211-00001	123	M22759/21-24*	81	M22759/41-22*	85	M22759/82-24*	89
M17/211-00002	123	M22759/21-26*	81	M22759/41-24*	85	M22759/82-26*	89
M17/212-00001	123	M22759/21-28*	81	M22759/41-26*	85	M22759/83-01*	89
M17/213-00001	123	M22759/22-20*	82	M22759/42-20*	85	M22759/83-1*	89
M17/214-00001	123	M22759/22-22*	82	M22759/42-22*	85	M22759/83-02*	89

California

1959 East Cashdan Street, Rancho Dominguez, CA 90220
 (310) 609-1811 • (800) 326-0006 • FAX: (310) 609-1862
 E-Mail: salesrd@std-wire.com

Arizona

3120 West Thomas Road, Bldg. #801, Phoenix, AZ 85017
 (602) 269-2501 • (800) 325-6478 • FAX: (602) 278-7134
 E-Mail: salesphx@std-wire.com



Standard Wire & Cable Co.

Catalog No.	Page No.	Catalog No.	Page No.	Catalog No.	Page No.	Catalog No.	Page No.
M22759/83-2*	89	M22759/88-12*	93	M81044/13-28*	97	M81381/17-24*	101
M22759/83-03*	89	M22759/88-14*	93	M81044/13-30*	97	M81381/17-26*	101
M22759/83-04*	89	M22759/88-16*	93	M81381/7-10*	98	M81381/21-10*	101
M22759/84-01*	90	M22759/88-18*	93	M81381/7-12*	98	M81381/21-12*	101
M22759/84-1*	90	M22759/88-20*	93	M81381/7-14*	98	M81381/21-14*	101
M22759/84-2*	90	M22759/88-22*	93	M81381/7-16*	98	M81381/21-16*	101
M22759/84-02*	90	M22759/88-24*	93	M81381/7-18*	98	M81381/21-18*	101
M22759/84-03*	90	M22759/88-26*	93	M81381/7-20*	98	M81381/21-20*	101
M22759/84-04*	90	M22759/89-20*	94	M81381/7-22*	98	M81381/21-22*	101
M22759/85-1*	90	M22759/89-22*	94	M81381/7-24*	98	M81381/21-24*	101
M22759/85-01*	90	M22759/89-24*	94	M81381/7-26*	98	M81381/21-26*	101
M22759/85-02*	90	M22759/89-26*	94	M81381/8-10*	98	M81381/22-01*	102
M22759/85-2*	90	M22759/90-20*	94	M81381/8-12*	98	M81381/22-02*	102
M22759/85-03*	90	M22759/90-22*	94	M81381/8-14*	98	M81381/22-2*	102
M22759/85-04*	90	M22759/90-24*	94	M81381/8-16*	98	M81381/22-4*	102
M22759/86-01*	91	M22759/90-26*	94	M81381/8-18*	98	M81381/22-6*	102
M22759/86-1*	91	M22759/91-10*	95	M81381/8-20*	98	M81381/22-8*	102
M22759/86-2*	91	M22759/91-12*	95	M81381/8-22*	98	M81381/22-10*	102
M22759/86-02*	91	M22759/91-14*	95	M81381/8-24*	98	M81381/22-12*	102
M22759/86-03*	91	M22759/91-16*	95	M81381/8-26*	98	M81381/22-14*	102
M22759/86-04*	91	M22759/91-18*	95	M81381/9-20*	99	M81381/22-16*	102
M22759/86-4*	91	M22759/91-20*	95	M81381/9-22*	99	M81381/22-18*	102
M22759/86-6*	91	M22759/91-22*	95	M81381/9-24*	99	M81381/22-20*	102
M22759/86-8*	91	M22759/91-24*	95	M81381/9-26*	99	M81381/22-22*	102
M22759/86-10*	91	M22759/91-26*	95	M81381/9-28*	99	M81381/22-24*	102
M22759/86-12*	91	M22759/92-10*	95	M81381/9-30*	99	XHTU-12/3	152
M22759/86-14*	91	M22759/92-12*	95	M81381/11-2*	99	XHTU-19/6	152
M22759/86-16*	91	M22759/92-14*	95	M81381/11-4*	99	XHTU-30/8	152
M22759/86-18*	91	M22759/92-16*	95	M81381/11-6*	99	XHTU-45/12	152
M22759/86-20*	91	M22759/92-18*	95	M81381/11-8*	99	XHTU-52/15	152
M22759/86-22*	91	M22759/92-20*	95	M81381/11-10*	99	XHTU-72/22	152
M22759/86-24*	91	M22759/92-22*	95	M81381/11-12*	99	XHTU-92/25	152
M22759/86-26*	91	M22759/92-24*	95	M81381/11-14*	99	XHTU-120/35	152
M22759/87-1*	92	M22759/92-26*	95	M81381/11-16*	99	XMTU-12/3	153
M22759/87-01*	92	M81044/9-0*	96	M81381/11-18*	99	XMTU-22/6	153
M22759/87-2*	92	M81044/9-2*	96	M81381/11-20*	99	XMTU-27/7	153
M22759/87-02*	92	M81044/9-4*	96	M81381/11-22*	99	XMTU-34/7	153
M22759/87-03*	92	M81044/9-6*	96	M81381/11-24*	99	XMTU-40/12	153
M22759/87-4*	92	M81044/9-8*	96	M81381/12-2*	100	XMTU-56/17	153
M22759/87-6*	92	M81044/9-10*	96	M81381/12-4*	100	XMTU-71/20	153
M22759/87-8*	92	M81044/9-12*	96	M81381/12-6*	100	XMTU-92/25	153
M22759/87-10*	92	M81044/9-14*	96	M81381/12-8*	100	XMTU-120/35	153
M22759/87-12*	92	M81044/9-16*	96	M81381/12-10*	100	XTPA 080	165
M22759/87-14*	92	M81044/9-18*	96	M81381/12-12*	100	XWSA-43/9	153
M22759/87-16*	92	M81044/9-20*	96	M81381/12-14*	100	XWSA-71/15	153
M22759/87-18*	92	M81044/9-22*	96	M81381/12-16*	100	XWSA-92/25	153
M22759/87-20*	92	M81044/9-24*	96	M81381/12-18*	100	XWSA-119/28	153
M22759/87-22*	92	M81044/12-12*	97	M81381/12-20*	100	XWSA-132/38	153
M22759/87-24*	92	M81044/12-14*	97	M81381/12-22*	100	XWSA-155/51	153
M22759/87-26*	92	M81044/12-16*	97	M81381/12-24*	100	XWSA-200/56	153
M22759/88-1*	93	M81044/12-18*	97	M81381/13-20*	100	080EK025	154
M22759/88-01*	93	M81044/12-20*	97	M81381/13-22*	100	137EK050	154
M22759/88-02*	93	M81044/12-22*	97	M81381/13-24*	100	200EK075	154
M22759/88-2*	93	M81044/12-24*	97	M81381/13-26*	100	380EK150	154
M22759/88-03*	93	M81044/12-26*	97	M81381/13-28*	100	300-5	50
M22759/88-04*	93	M81044/12-28*	97	M81381/17-12*	101	300-8	50
M22759/88-4*	93	M81044/12-30*	97	M81381/17-14*	101	300-12	50
M22759/88-6*	93	M81044/13-20*	97	M81381/17-16*	101	300-13	50
M22759/88-8*	93	M81044/13-22*	97	M81381/17-18*	101	300-15	50
M22759/88-10*	93	M81044/13-24*	97	M81381/17-20*	101	300-18	50
		M81044/13-26*	97	M81381/17-22*	101	300-19	50

California

1959 East Cashdan Street, Rancho Dominguez, CA 90220
(310) 609-1811 • (800) 326-0006 • FAX: (310) 609-1862

E-Mail: salesrd@std-wire.com

Arizona

3120 West Thomas Road, Bldg. #801, Phoenix, AZ 85017
(602) 269-2501 • (800) 325-6478 • FAX: (602) 278-7134

E-Mail: salesphx@std-wire.com



Standard Wire & Cable Co.

Catalog No.	Page No.	Catalog No.	Page No.	Catalog No.	Page No.	Catalog No.	Page No.
300-19B	50	303-16	51	401-3F-C3	14	401-12FP-C5	24
300-20	50	303-17	51	401-3F-C4	15	401-12FPS	21
300-23	50	303-18	51	401-3F-C5	16	401-12FPS-C5	25
300-23B	50	400-4	4	401-3FP	21	401-12FS	13
300-26	50	400-4A	2	401-3FP-C3	22	401-12FS-C5	17
300-28	50	400-4BC	3	401-3FP-C4	23	401-15	7
300-28B	50	400-4PL	18	401-3FP-C5	24	401-15B	5
300-30	50	400-5	4	401-3FPS	21	401-15N	5
300-31	50	400-5PL	18	401-3FPS-C5	25	401-19	7
300-33	50	400-8	4	401-3FS	13	401-19B	5
300-35	50	400-8A	2	401-3FS-C5	17	401-25F	12
300-38	50	400-8BC	3	401-3N	5	401-25F-C3	14
300-40	50	400-8FA	11	401-4	7	401-25F-C4	15
300-42	50	400-8PL	18	401-4B	5	401-25F-C5	16
300-44	50	400-9	4	401-4F	12	401-25FP	21
300-46	50	400-9BC	3	401-4F-C3	14	401-25FP-C3	22
300-48	50	400-10	4	401-4F-C4	15	401-25FP-C4	23
300-50	50	400-11	4	401-4F-C5	16	401-25FP-C5	24
300-51	50	400-16	4	401-4FP	21	401-25FPS	21
300-52	50	400-16BC	3	401-4FP-C3	22	401-25FPS-C5	25
300-53	50	400-16FA	11	401-4FP-C4	23	401-25FS	13
300-55	50	400-16FPL	26	401-4FP-C5	24	401-25FS-C5	17
300-56	50	400-16PL	18	401-4FPS	21	401-27	7
300-57	50	400-17	4	401-4FPS-C5	25	401-27B	5
300-59	50	400-17PL	18	401-4FS	13	401-50F	12
300-61	50	400-20	4	401-4FS-C5	17	401-50FP	21
301-3	68	400-20BC	3	401-6	7	401-51	7
301-6	68	400-20FA	11	401-6B	5	401-51B	5
301-9	68	400-20FPL	26	401-6F	12	401-75F	12
301-12	68	400-20PL	18	401-6F-C3	14	401-75FP	21
301-15	68	400-25	4	401-6F-C4	15	401-100F	12
301-18	68	400-25FA	11	401-6F-C5	16	401-100F-C3	14
301-21	68	400-25FPL	26	401-6FP	21	401-100FP	21
302-3	51	400-25PL	18	401-6FP-C3	22	401-100FP-C3	22
302-4	51	400-26	4	401-6FP-C4	23	402-1F	27
302-5	51	400-27	4	401-6FP-C5	24	402-2	1
302-6	51	400-27FA	11	401-6FPS	21	402-8	1
302-7	51	400-27PL	18	401-6FPS-C5	25	402-14	1
302-8	51	400-30	4	401-6FS	13	402-16	1
302-9	51	400-30FA	11	401-6FS-C5	17	402-23	10
302-10	51	400-34FA	11	401-6N	5	402-29	1
302-11	51	400-38FA	11	401-8F-C3	14	402-32	10
302-12	51	401-1	7	401-8F-C4	15	402-34	1
302-13	51	401-1B	5	401-8F-C5	16	402-35	10
302-14	51	401-2	7	401-8FP-C3	22	405-2A	6
302-15	51	401-2B	5	401-8FP-C4	23	405-2AG	7
302-16	51	401-2F	12	401-8FP-C5	24	405-2AGP	20
302-17	51	401-2F-C3	14	401-8FPS-C5	25	405-2APL	26
302-18	51	401-2F-C4	15	401-8FS-C5	17	405-2B	6
302-19	51	401-2F-C5	16	401-9	7	405-3A	6
303-7	51	401-2FP	21	401-9B	5	405-3APL	26
303-8	51	401-2FP-C3	22	401-9N	5	405-3B	6
303-9	51	401-2FP-C4	23	401-11	7	405-3G	6
303-10	51	401-2FP-C5	24	401-11B	5	405-6A	6
303-11	51	401-2FPS-C5	25	401-12F	12	405-6APL	26
303-12	51	401-2FS-C5	17	401-12F-C3	14	405-6B	6
303-13	51	401-2N	5	401-12F-C4	15	405-6G	6
303-13F	69	401-3	7	401-12F-C5	16	405-9A	6
303-14	51	401-3B	5	401-12FP	21	405-9B	6
303-14D	69	401-3C	5	401-12FP-C3	22	405-9G	6
303-15	51	401-3F	12	401-12FP-C4	23	405-11A	6

California

1959 East Cashdan Street, Rancho Dominguez, CA 90220
 (310) 609-1811 • (800) 326-0006 • FAX: (310) 609-1862
 E-Mail: salesrd@std-wire.com

Arizona

3120 West Thomas Road, Bldg. #801, Phoenix, AZ 85017
 (602) 269-2501 • (800) 325-6478 • FAX: (602) 278-7134
 E-Mail: salesphx@std-wire.com



Standard Wire & Cable Co.

Catalog No.	Page No.	Catalog No.	Page No.	Catalog No.	Page No.	Catalog No.	Page No.
405-11B	6	500-66D	54	501-82A	57	502-110AB	53
405-15A	6	500-67A	55	501-88	52	502-110D	54
405-15B	6	500-69A	56	501-88AB	52	502-111A	55
405-15G	6	500-71A	57	501-88D	54	502-113A	56
405-19A	6	500-77	52	501-89A	55	502-115A	57
405-19B	6	500-77AB	52	501-91A	56	502-121	53
405-27A	6	500-77D	54	501-93A	57	502-121AB	53
405-27B	6	500-78A	55	502-22	53	502-121D	54
405-51A	6	500-80A	56	502-22A	53	502-132	53
405-51B	6	500-82A	57	502-22AA	53	502-132AB	53
500-0	52	501-11	52	502-22AB	53	502-143	53
500-0A	52	501-11A	52	502-22D	54	502-143AB	53
500-0D	54	501-11AA	52	502-22DA	54	502-154	53
500-1	52	501-11AB	52	502-33	53	502-154AB	53
500-1A	52	501-11D	54	502-33A	53	502-165	53
500-1D	54	501-22	52	502-33AA	53	502-165AB	53
500-11	52	501-22A	52	502-33AB	53	503-6B	27
500-11A	52	501-22AA	52	502-33D	54	503-6C	27
500-11AA	52	501-22AB	52	502-33DA	54	503-7C	27
500-11AB	52	501-22D	54	502-34A	55	503-9C	27
500-11D	54	501-22DA	54	502-36A	56	504-1B	27
500-12	55	501-23	55	502-38A	57	504-2B	27
500-14	56	501-23A	55	502-44	53	504-5B	27
500-16	57	501-25	56	502-44A	53	504-6B	27
500-22	52	501-25A	56	502-44AA	53	504-7	31
500-22A	52	501-27	57	502-44AB	53	504-8A	9
500-22AA	52	501-27A	57	502-44DA	54	504-14A	9
500-22AB	52	501-33	52	502-45A	55	504-15A	9
500-22D	54	501-33A	52	502-47A	56	504-15APL	19
500-22DA	54	501-33AA	52	502-49A	57	504-20A	9
500-23	55	501-33AB	52	502-55A	53	504-20APL	19
500-23A	55	501-33D	54	502-55AB	53	504-24A	9
500-25	56	501-33DA	54	502-55DA	54	504-25A	8
500-25A	56	501-34A	55	502-56A	55	504-25APL	19
500-27	57	501-36A	56	502-58A	56	504-34A	9
500-27A	57	501-38A	57	502-60A	57	504-40	31
500-33	52	501-44	52	502-66	53	504-42	31
500-33A	52	501-44A	52	502-66AB	53	504-49A	9
500-33AA	52	501-44AA	52	502-66D	54	504-67A	9
500-33AB	52	501-44AB	52	502-67A	55	504-67APL	19
500-33D	54	501-44DA	54	502-69A	56	504-67FA	10
500-33DA	54	501-45A	55	502-71A	57	504-67FAP	27
500-34A	55	501-47A	56	502-77	53	504-71A	9
500-36A	56	501-49A	57	502-77AB	53	504-71APL	19
500-38A	57	501-55A	52	502-77D	54	504-72A	9
500-44	52	501-55AB	52	502-78A	55	504-72APL	19
500-44A	52	501-55DA	54	502-80A	56	504-72FA	10
500-44AA	52	501-56A	55	502-82A	57	504-72FAP	27
500-44AB	52	501-58A	56	502-88	53	504-74A	9
500-44DA	54	501-60A	57	502-88AB	53	504-74AB	8
500-45A	55	501-66	52	502-88D	54	504-74APL	19
500-47A	56	501-66AB	52	502-89A	55	504-74B	34
500-49A	57	501-66D	54	502-91A	56	504-74C	34
500-55A	52	501-67A	55	502-93A	57	504-74FA	10
500-55AB	52	501-69A	56	502-99	53	504-74FAP	27
500-55DA	54	501-71A	57	502-99AB	53	504-75AB	8
500-56A	55	501-77	52	502-99D	54	504-75APL	19
500-58A	56	501-77AB	52	502-100A	55	504-75FA	10
500-60A	57	501-77D	54	502-102A	56	504-76APL	19
500-66	52	501-78A	55	502-104A	57	504-87AB	8
500-66AB	52	501-80A	56	502-110	53	504-87FA	10

California

1959 East Cashdan Street, Rancho Dominguez, CA 90220
(310) 609-1811 • (800) 326-0006 • FAX: (310) 609-1862

E-Mail: salesrd@std-wire.com

Arizona

3120 West Thomas Road, Bldg. #801, Phoenix, AZ 85017
(602) 269-2501 • (800) 325-6478 • FAX: (602) 278-7134

E-Mail: salesphx@std-wire.com



Standard Wire & Cable Co.

Catalog No.	Page No.	Catalog No.	Page No.	Catalog No.	Page No.	Catalog No.	Page No.
504-89FA	10	507-23	126	507-58TN	30	507-90	129
504-90AB	8	507-23A	126	507-59	28	507-91	129
504-90FA	10	507-24	126	507-59	127	507-92	129
504-94FA	10	507-24A	126	507-59A	127	507-93	129
507-4	125	507-25	126	507-59AF	28	507-94	129
507-5	125	507-25A	126	507-59B	127	507-94A	129
507-5A	125	507-26	126	507-59BF	28	507-95	129
507-5B	125	507-26A	126	507-59F	30	507-96	129
507-6	125	507-27	126	507-59FA	30	507-97	129
507-6A	125	507-27A	126	507-59FAP	29	507-98	129
507-6F	30	507-28	126	507-59P	28	507-99	129
507-6FA	30	507-28A	126	507-59PL	29	507-100	129
507-6FAP	29	507-28B	126	507-59Q	30	507-101	129
507-6FBC	30	507-29	126	507-60	127	507-102	129
507-6FBP	29	507-30	126	507-61	127	507-103	129
507-6P	31	507-31	126	507-62	28	507-104	129
507-6PV	31	507-32	126	507-62	127	507-105	129
507-6Q	30	507-33	126	507-62A	28	507-106	129
507-6QBC	30	507-34	126	507-62A	127	507-107	129
507-6QBP	29	507-34A	126	507-62AP	28	507-108	129
507-6QP	29	507-34B	126	507-62APL	29	507-108A	129
507-7	125	507-35	126	507-62B	128	507-109	129
507-8	28	507-35A	126	507-63	128	507-110	129
507-8	125	507-35B	126	507-63A	128	507-111	129
507-8A	28	507-36	127	507-63B	128	507-111A	129
507-8A	125	507-37	127	507-64	128	507-112	129
507-8F	28	507-38	127	507-64A	128	507-113	129
507-8P	28	507-39	127	507-65	128	507-114	129
507-9	125	507-40	127	507-65A	128	507-114A	129
507-9A	125	507-41	127	507-66	128	507-115	130
507-9B	125	507-42	127	507-67	128	507-115A	130
507-10	125	507-43	127	507-68	128	507-116	130
507-10A	125	507-44	127	507-69	128	507-117	130
507-11	28	507-45	127	507-70	128	507-117A	130
507-11	125	507-46	127	507-71	128	507-118	130
507-11A	28	507-47	127	507-71A	128	507-118A	130
507-11A	125	507-48	127	507-71B	128	507-119	130
507-11F	28	507-49	127	507-72	128	507-120	130
507-11P	28	507-50	127	507-73	128	507-121	130
507-12	125	507-51	127	507-74	128	507-122	130
507-12A	125	507-52	127	507-74A	128	507-123	130
507-13	125	507-53	127	507-75	128	507-124	130
507-13A	125	507-54	127	507-76	128	507-125	130
507-14	125	507-54A	127	507-77A	128	507-126	130
507-14A	125	507-55	127	507-78A	128	507-128	130
507-15	125	507-55A	127	507-79	128	507-129	130
507-16	125	507-55B	127	507-79A	128	507-130	130
507-17	125	507-56	127	507-79B	128	507-131	130
507-17A	125	507-57	127	507-80	128	507-132	130
507-17B	125	507-57A	127	507-81	128	507-133	130
507-18	125	507-58	28	507-82	128	507-133A	130
507-18A	125	507-58	127	507-83	128	507-134	130
507-19	125	507-58A	28	507-84A	128	507-135	130
507-19A	125	507-58A	127	507-85A	128	507-136	130
507-20	125	507-58APL	29	507-86	128	507-137	130
507-20A	126	507-58B	127	507-87	129	507-138	130
507-21	126	507-58C	28	507-87A	129	507-139	130
507-21A	126	507-58C	127	507-88	129	507-140	130
507-22	126	507-58P	28	507-88A	129	507-141	130
507-22A	126	507-58PL	29	507-88B	129	507-141A	130
507-22B	126	507-58PTN	29	507-89	129	507-142	130

California

1959 East Cashdan Street, Rancho Dominguez, CA 90220
 (310) 609-1811 • (800) 326-0006 • FAX: (310) 609-1862
 E-Mail: salesrd@std-wire.com

Arizona

3120 West Thomas Road, Bldg. #801, Phoenix, AZ 85017
 (602) 269-2501 • (800) 325-6478 • FAX: (602) 278-7134
 E-Mail: salesphx@std-wire.com



Standard Wire & Cable Co.

Catalog No.	Page No.	Catalog No.	Page No.	Catalog No.	Page No.	Catalog No.	Page No.
507-142A	130	507-191	132	507-247	134	507-305	136
507-142B	131	507-192	132	507-248	134	507-306A	136
507-143	131	507-193	133	507-249	134	507-307A	136
507-143A	131	507-194	133	507-250	134	507-316	136
507-144	131	507-195	133	507-251	135	507-317	137
507-145	131	507-195A	133	507-252	135	507-318	137
507-146	131	507-196	133	507-253	135	507-319	137
507-147	131	507-196A	133	507-254	135	507-321	137
507-148	131	507-197	133	507-255	135	507-322	137
507-149	131	507-198	133	507-256	135	507-323	137
507-150	131	507-199	133	507-257	135	507-324	137
507-151	131	507-200	133	507-258	135	507-325	137
507-152	131	507-201	133	507-259	135	507-326	137
507-153	131	507-202	133	507-260	135	507-327	137
507-154	131	507-203	133	507-261	135	507-328	137
507-155	131	507-204	133	507-262	135	507-329	137
507-156	131	507-205	133	507-263	135	507-330	137
507-157	131	507-206	133	507-264	135	507-331	137
507-158	131	507-207	133	507-264A	135	507-332	137
507-159	131	507-208	133	507-264B	135	507-333	137
507-160	131	507-209	133	507-264C	135	507-334	137
507-160A	131	507-210	133	507-265	135	507-335	137
507-161	131	507-211	133	507-266	135	507-336	137
507-162	131	507-211A	133	507-267	135	507-360	137
507-163	131	507-212	133	507-268	135	507-366	137
507-164	131	507-213	133	507-269	135	507-367	137
507-165	131	507-214	133	507-270	135	507-369	137
507-166	131	507-215	133	507-271	135	507-370	137
507-167	131	507-216	133	507-272	135	507-373	137
507-168	131	507-217	133	507-273	135	507-374	137
507-169	131	507-218	133	507-274	135	507-376	137
507-170	131	507-219	133	507-275	135	507-377	137
507-171	131	507-220	133	507-276	135	507-378	138
507-172	131	507-221	133	507-277	135	507-382	138
507-173	132	507-222	134	507-278	135	507-383	138
507-174	132	507-223	134	507-279	136	507-384	138
507-174A	132	507-224	134	507-280	136	507-385	138
507-175	132	507-225	134	507-281	136	507-386	138
507-176	132	507-226	134	507-282	136	507-388	138
507-177	132	507-227	134	507-283	136	507-389	138
507-178	132	507-228	134	507-284A	136	507-391	138
507-178A	132	507-228A	134	507-285A	136	507-392	138
507-178B	132	507-229	134	507-286	136	507-393	138
507-179	132	507-230	134	507-287	136	507-400	138
507-179A	132	507-231	134	507-288	136	507-401	138
507-179B	132	507-231A	134	507-289	136	507-402	138
507-180	132	507-232	134	507-290	136	507-403	138
507-180A	132	507-233	134	507-291	136	507-404	138
507-180B	132	507-234	134	507-292	136	507-405	138
507-181	132	507-235	134	507-293	136	701-4	38
507-182	132	507-236	134	507-293A	136	701-6	38
507-183	132	507-237	134	507-294	136	701-8	38
507-184	132	507-238	134	507-294A	136	701-10	38
507-185	132	507-239	134	507-295	136	701-12	38
507-186	132	507-240	134	507-296	136	701-14	38
507-187	132	507-241	134	507-297	136	701-16	38
507-187A	132	507-242	134	507-298	136	701-18	38
507-188	132	507-243	134	507-301	136	702-3	38
507-188A	132	507-244	134	507-302	136	702-5	38
507-189	132	507-245	134	507-303	136	702-7	38
507-190	132	507-246	134	507-304	136	702-9	38

California

1959 East Cashdan Street, Rancho Dominguez, CA 90220
(310) 609-1811 • (800) 326-0006 • FAX: (310) 609-1862

E-Mail: salesrd@std-wire.com

Arizona

3120 West Thomas Road, Bldg. #801, Phoenix, AZ 85017
(602) 269-2501 • (800) 325-6478 • FAX: (602) 278-7134

E-Mail: salesphx@std-wire.com



Standard Wire & Cable Co.

Catalog No.	Page No.	Catalog No.	Page No.	Catalog No.	Page No.	Catalog No.	Page No.
702-11	38	710-2	35	801-176	69	1050-5-9A	60
702-13	38	710-3	35	857-1	40	1050-5-9C	60
702-15	38	710-3A	35	857-2	40	1050-6-9	60
702-17	38	710-3B	35	857-3	40	1050-6-9A	60
702-19	38	710-4	35	857-4	40	1050-7-9	60
703-1	39	710-4B	35	857-5	40	1050-7-9A	60
703-1A	39	710-5	35	857-6	40	1050-8-9	60
703-2	39	710-6	35	857-8	40	1050-8-9A	60
703-3	39	710-7	35	857-10	40	1050-9-9A	60
703-4	39	710-8	35	865-2	40	1090-30	80
703-5	39	710-9	35	865-4	40	1090-35	80
703-6	39	710-10	35	865-6	40	1090-40	80
703-7	39	710-11	35	865-8	40	1090-45	80
703-8	39	710-12	35	865-10	40	1090-50	80
703-9	39	710-13	35	865-12	40	1090-55	80
703-10	39	710-15	35	865-14	40	1090-60	80
703-11	39	710-16	35	865-16	40	1090-65	80
703-12	39	710-17	35	869-4	41	1090-70	80
703-13	39	710-18	35	869-6	41	1090-75	80
703-14	39	710-18B	35	869-8	41	1090-80	80
703-15	39	710-18E	35	869-10	41	1090-85	80
703-16	39	710-20	35	869-12	41	1090-90	80
703-17	39	710-20B	35	869-14	41	1090-95	80
703-18	39	710-21	35	869-15	41	1090-100	80
703-19	39	710-21B	35	869-18	41	1091-3	80
703-20	39	710-22	35	875-1	41	1091-5	80
703-20A	39	710-22E	35	875-2	41	1091-10	80
703-22	39	710-23	37	875-3	41	1091-15	80
703-22A	39	710-24	37	875-4	41	1091-20	80
703-24	39	711-1	37	875-5	41	1091-25	80
703-26	39	711-2	37	875-6	41	1091-30	80
703-28	39	711-3	37	875-7	41	1091-45	80
703-30	39	711-4	37	875-8	41	1091-50	80
704-2	68	711-8	36	875-10	41	1100-10	58
704-3	68	711-9	36	875-14	41	1100-10C	58
704-4	68	711-10	36	875-16	41	1100-21	58
704-5	68	711-11	36	903-1	34	1100-21C	58
704-6	68	711-12	36	903-2	34	1100-21E	64
706-3A	69	711-13	36	913L46	158	1100-21F	64
706-3B	69	711-14	36	913L47	158	1100-22E	65
706-3G	67	711-16	36	913L48	158	1100-22F	65
706-5G	67	711-18	36	913L49	158	1100-22S	65
706-5GA	67	711-21	36	913L50	158	1100-22T	65
706-7G	67	712-1	37	913L51	158	1100-22W	66
706-7GA	67	712-2	37	913L52	158	1100-22X	66
706-8G	67	712-3	37	913L53	158	1100-32	58
706-11G	67	712-4	37	913L54	158	1100-32C	58
706-14G	67	712-8	36	913L66	157	1100-32E	64
706-15G	67	712-9	36	913L67	157	1100-32F	64
706-16G	67	712-10	36	913L68	157	1100-33E	65
706-17G	67	712-11	36	913L69	157	1100-33F	65
706-18G	67	712-12	36	913L70	157	1100-33S	65
706-19G	67	712-13	36	913RL48	156	1100-33T	65
706-21G	67	712-14	36	913RL49	156	1100-33W	66
708-5	68	712-16	36	913RL50	156	1100-33X	66
708-10	68	712-18	36	913RL51	156	1100-43	58
708-11	68	712-21	36	913RL52	156	1100-43A	58
709-2	1	801-10	27	1050-3-9	60	1100-43C	58
709-7	1	801-30	27	1050-4-9	60	1100-43E	64
709-14	1	801-45	27	1050-4-9C	60	1100-43F	64
710-1	35	801-175	69	1050-5-9	60	1100-44E	65

California

1959 East Cashdan Street, Rancho Dominguez, CA 90220
 (310) 609-1811 • (800) 326-0006 • FAX: (310) 609-1862
 E-Mail: salesrd@std-wire.com

Arizona

3120 West Thomas Road, Bldg. #801, Phoenix, AZ 85017
 (602) 269-2501 • (800) 325-6478 • FAX: (602) 278-7134
 E-Mail: salesphx@std-wire.com



Standard Wire & Cable Co.

Catalog No.	Page No.	Catalog No.	Page No.	Catalog No.	Page No.	Catalog No.	Page No.
1100-44F	65	1100-120E	64	1103-75D	74	1107-34B	75
1100-44S	65	1100-120F	64	1103-79B	73	1107-39B	75
1100-44T	65	1100-131A	58	1103-79C	73	1107-46B	75
1100-44W	66	1101-21	59	1103-79D	74	1107-51B	75
1100-44X	66	1101-21C	59	1103-83B	73	1107-58B	75
1100-54	58	1101-32	59	1103-83C	73	1107-63B	75
1100-54A	58	1101-32C	59	1103-83D	74	1107-70B	75
1100-54C	58	1101-43	59	1103-87B	73	1107-75B	75
1100-54E	64	1101-43A	59	1103-87C	73	1107-79B	75
1100-54F	64	1101-43C	59	1103-91B	73	1107-83B	75
1100-55E	65	1101-54	59	1103-91C	73	1126-24	42
1100-55F	65	1101-54A	59	1104-2	72	1126-44	42
1100-55S	65	1101-54C	59	1104-2A	72	1126-54	42
1100-55T	65	1101-65	59	1104-6	72	1126-71	42
1100-55W	66	1101-65A	59	1104-6A	72	1126-77	42
1100-55X	66	1101-65C	59	1104-10	72	1126-84	42
1100-65	58	1101-76	59	1104-10A	72	1126-88	42
1100-65A	58	1101-76A	59	1104-14	72	1126-90	42
1100-65C	58	1101-76C	59	1104-14A	72	1126-92	42
1100-65E	64	1101-87A	59	1104-16A	72	1126-94	42
1100-65F	64	1101-87C	59	1104-18	72	1126-96	42
1100-66E	65	1101-98A	59	1104-22	72	1126-98	42
1100-66F	65	1101-109A	59	1104-22A	72	1126-110	42
1100-66S	65	1101-120A	59	1104-26	72	1126-120	42
1100-66T	65	1101-131A	59	1104-30	72	1126-130	42
1100-66W	66	1101-142A	59	1104-34	72	1126-140	42
1100-66X	66	1103-10B	73	1104-38	72	1130-9	43
1100-76	58	1103-10C	73	1104-42	72	1130-12	43
1100-76A	58	1103-10D	74	1104-46	72	1130-15	43
1100-76C	58	1103-17B	73	1104-50	72	1130-18	43
1100-76E	64	1103-17C	73	1104-60	72	1130-21	43
1100-76F	64	1103-17D	74	1104-70	72	1130-24	43
1100-77E	65	1103-23B	73	1104-80	72	1130-27	43
1100-77F	65	1103-23C	73	1105-3	70	1130-30	43
1100-77S	65	1103-23D	74	1105-6	70	1130-33	43
1100-77T	65	1103-30B	73	1105-9	70	1130-36	43
1100-77W	66	1103-30C	73	1105-12	70	1130-39	43
1100-77X	66	1103-30D	74	1105-15	70	1130-42	43
1100-87A	58	1103-34B	73	1105-18	70	1130-45	43
1100-87C	58	1103-34C	73	1105-21	70	1130-48	43
1100-87E	64	1103-34D	74	1105-24	70	1165-32	76
1100-87F	64	1103-39B	73	1105-27	70	1165-34	76
1100-88E	65	1103-39C	73	1105-30	70	1165-39	76
1100-88F	65	1103-39D	74	1105-33	70	1165-44	76
1100-88S	65	1103-46B	73	1105-36	70	1165-49	76
1100-88T	65	1103-46C	73	1105-39	70	1165-54	76
1100-88W	66	1103-46D	74	1105-46	70	1165-60	76
1100-88X	66	1103-51B	73	1106-4	71	1165-64	76
1100-98A	58	1103-51C	73	1106-7	71	1165-69	76
1100-98E	64	1103-51D	74	1106-10	71	1165-74	76
1100-98F	64	1103-58B	73	1106-13	71	1165-79	76
1100-99E	65	1103-58C	73	1106-16	71	1166-32	76
1100-99F	65	1103-58D	74	1106-19	71	1166-34	76
1100-99S	65	1103-63B	73	1106-22	71	1166-39	76
1100-99T	65	1103-63C	73	1106-25	71	1166-44	76
1100-99W	66	1103-63D	74	1106-28	71	1166-49	76
1100-99X	66	1103-70B	73	1106-31	71	1166-54	76
1100-109A	58	1103-70C	73	1107-10B	75	1166-60	76
1100-109E	64	1103-70D	74	1107-17B	75	1166-64	76
1100-109F	64	1103-75B	73	1107-23B	75	1166-69	76
1100-120A	58	1103-75C	73	1107-30B	75	1166-74	76

California

1959 East Cashdan Street, Rancho Dominguez, CA 90220
(310) 609-1811 • (800) 326-0006 • FAX: (310) 609-1862

E-Mail: salesrd@std-wire.com

Arizona

3120 West Thomas Road, Bldg. #801, Phoenix, AZ 85017
(602) 269-2501 • (800) 325-6478 • FAX: (602) 278-7134

E-Mail: salesphx@std-wire.com



Standard Wire & Cable Co.

Catalog No.	Page No.	Catalog No.	Page No.	Catalog No.	Page No.	Catalog No.	Page No.
1166-79	76	1327-7APL	19	1505-106	170	5002-S	46
1167-32	77	1327-7PL	18	1505-107	170	5003	44
1167-34	77	1327-8	4	1505-108	170	5003-S	46
1167-39	77	1327-8APL	19	1505-108D	170	5004	44
1167-44	77	1327-8FPL	26	1505-109	170	5004-S	46
1167-49	77	1327-8PL	18	1505-110	170	5005	44
1167-54	77	1327-9	4	1505-111	170	5005-S	46
1167-60	77	1327-10	4	1505-112	170	5006	44
1167-64	77	1327-12	4	1505-113	170	5006-S	46
1167-69	77	1327-12FA	11	1505-114	170	5007	44
1167-74	77	1327-14FA	11	1505-302	171	5007-S	46
1167-79	77	1327-15	4	1505-304	171	5008	44
1168-32	77	1327-19	4	1505-306	171	5008-S	46
1168-34	77	1327-25	4	1505-307	171	5009	44
1168-39	77	1336-50	68	1505-308	171	5009-S	46
1168-44	77	1336-50B	68	1505-309	171	5010	44
1168-49	77	1336-51	68	1505-310	171	5010-S	46
1168-54	77	1501-99	166	1505-311	171	5011	44
1168-60	77	1501-100	166	1506-101	173	5011-S	46
1168-64	77	1501-101	166	1506-102	173	5012	44
1168-69	77	1501-102	166	1506-103	173	5012-S	46
1168-74	77	1501-103	166	1506-104	173	5013	44
1168-79	77	1501-104	166	1506-105	173	5013-S	46
1326-3	4	1501-105	166	1506-106	173	5014	44
1326-3APL	19	1501-106	166	1506-107	173	5014-S	46
1326-3BC	3	1501-107	166	1506-108	173	5015	44
1326-3PL	18	1501-108	166	1506-112	173	5015-S	46
1326-12FA	11	1501-109	166	1508-101	174	5016	44
1326-13	4	1501-110	166	1508-102	174	5016-S	46
1326-13A	9	1501-111	166	1508-103	174	5017	44
1326-13APL	19	1504-101	167	1508-104	174	5017-S	46
1326-13BC	3	1504-102	167	1508-105	174	5018	44
1326-13BCA	2	1504-103	167	1508-106	174	5018-S	46
1326-13PL	18	1504-104	167	1508-107	174	5019	44
1326-14	4	1504-105	167	1508-108	174	5019-S	46
1326-14A	9	1504-106	167	1508-109	174	5020	44
1326-14APL	19	1504-107	167	1508-110	174	5020-S	46
1326-14BC	3	1504-301	168	1513-100	175	5021	44
1326-14BCA	2	1504-301A	168	1513-101	175	5021-S	46
1326-16	4	1504-302	168	1513-102	175	5022	44
1326-16A	9	1504-302A	168	1513-103	175	5022-S	46
1326-16APL	19	1504-303	168	1513-104	175	5023	44
1326-16BC	3	1504-303A	168	1513-106	175	5023-S	46
1326-16BCA	2	1504-304	168	1513-106D	175	5024	44
1326-16FA	11	1504-305	168	1513-108	175	5024-S	46
1326-17	4	1504-401	169	1513-110	175	5025	44
1326-17A	9	1504-402	169	1513-111	175	5025-S	46
1326-17BC	3	1504-403	169	1516-99	176	5026	44
1326-17BCA	2	1504-403A	169	1516-100	176	5026-S	46
1326-18	4	1504-404	169	1516-101	176	5027	44
1326-20	4	1504-405	169	1516-102	176	5027-S	46
1326-25	4	1504-410	172	1516-103	176	5028	44
1327-5	4	1504-411	172	1516-103A	176	5028-S	46
1327-5APL	19	1504-412	172	1516-104	176	5101	44
1327-5PL	18	1504-413	172	1516-104A	176	5101-S	46
1327-6	4	1504-414	172	1516-105	176	5102	44
1327-6A	9	1505-101	170	1516-105A	176	5102-S	46
1327-6APL	19	1505-102	170	1516-106	176	5103	44
1327-6FPL	26	1505-103	170	5001	44	5103-S	46
1327-6PL	18	1505-104	170	5001-S	46	5104	44
1327-7	4	1505-105	170	5002	44	5104-S	46

California

1959 East Cashdan Street, Rancho Dominguez, CA 90220
 (310) 609-1811 • (800) 326-0006 • FAX: (310) 609-1862
 E-Mail: salesrd@std-wire.com

Arizona

3120 West Thomas Road, Bldg. #801, Phoenix, AZ 85017
 (602) 269-2501 • (800) 325-6478 • FAX: (602) 278-7134
 E-Mail: salesphx@std-wire.com



Standard Wire & Cable Co.

Catalog No.	Page No.	Catalog No.	Page No.	Catalog No.	Page No.	Catalog No.	Page No.
5105	44	5207-S	47	5310	45	5602-S	49
5105-S	46	5208	45	5310-S	47	5603-S	49
5106	44	5208-S	47	5311	45	5604-S	49
5106-S	46	5209	45	5311-S	47	5605-S	49
5107	44	5209-S	47	5312	45	5606-S	49
5107-S	46	5210	45	5312-S	47	5607-S	49
5108	44	5210-S	47	5313	45	5608-S	49
5108-S	46	5211	45	5313-S	47	5609-S	49
5109	44	5211-S	47	5314	45	5610-S	49
5109-S	46	5212	45	5314-S	47	5611-S	49
5110	44	5212-S	47	5315	45	5701-S	49
5110-S	46	5213	45	5315-S	47	5702-S	49
5111	44	5213-S	47	5316	45	5703-S	49
5111-S	46	5214	45	5316-S	47	5704-S	49
5112	44	5214-S	47	5317	45	5705-S	49
5112-S	46	5215	45	5317-S	47	5706-S	49
5113	44	5215-S	47	5318	45	5707-S	49
5113-S	46	5216	45	5318-S	47	5708-S	49
5114	44	5216-S	47	5319	45	5709-S	49
5114-S	46	5217	45	5319-S	47	5710-S	49
5115	44	5217-S	47	5320	45	5711-S	49
5115-S	46	5218	45	5320-S	47	91342-1	160
5116	44	5218-S	47	5321	45	91342-2	160
5116-S	46	5219	45	5321-S	47	91342-3	160
5117	44	5219-S	47	5322	45	91342-4	160
5117-S	46	5220	45	5322-S	47	91342-12	159
5118	44	5220-S	47	5323	45	91342-34	159
5118-S	46	5221	45	5323-S	47	91343-1	160
5119	44	5221-S	47	5324	45	91343-2	160
5119-S	46	5222	45	5324-S	47	91343-2A	160
5120	44	5222-S	47	5325	45	91343-3	160
5120-S	46	5223	45	5325-S	47	91343-4	160
5121	44	5223-S	47	5326	45	91343-5	160
5121-S	46	5224	45	5326-S	47	91343-6	160
5122	44	5224-S	47	5327	45	91343-11	159
5122-S	46	5225	45	5327-S	47	91343-910	159
5123	44	5225-S	47	5328	45	91343-5678	159
5123-S	46	5226	45	5328-S	47	91344-1	161
5124	44	5226-S	47	5401-S	48	91344-2	161
5124-S	46	5227	45	5402-S	48	91344-3	161
5125	44	5227-S	47	5403-S	48	91344-4	161
5125-S	46	5228	45	5404-S	48	91344-5	161
5126	44	5228-S	47	5405-S	48	91344-6	161
5126-S	46	5301	45	5406-S	48	91344-1213	159
5127	44	5301-S	47	5407-S	48	91344-1415	159
5127-S	46	5302	45	5408-S	48	91344-1617	159
5128	44	5302-S	47	5409-S	48	91346	155
5128-S	46	5303	45	5410-S	48	91346-3	161
5201	45	5303-S	47	5411-S	48	91346-18	159
5201-S	47	5304	45	5501-S	48	91347	155
5202	45	5304-S	47	5502-S	48	91348	155
5202-S	47	5305	45	5503-S	48	91348-2	161
5203	45	5305-S	47	5504-S	48	91349	155
5203-S	47	5306	45	5505-S	48	91350	155
5204	45	5306-S	47	5506-S	48	91351	155
5204-S	47	5307	45	5507-S	48	91352	155
5205	45	5307-S	47	5508-S	48	91353	155
5205-S	47	5308	45	5509-S	48	91354	155
5206	45	5308-S	47	5510-S	48		
5206-S	47	5309	45	5511-S	48		
5207	45	5309-S	47	5601-S	49		

California

1959 East Cashdan Street, Rancho Dominguez, CA 90220
(310) 609-1811 • (800) 326-0006 • FAX: (310) 609-1862

E-Mail: salesrd@std-wire.com

Arizona

3120 West Thomas Road, Bldg. #801, Phoenix, AZ 85017
(602) 269-2501 • (800) 325-6478 • FAX: (602) 278-7134

E-Mail: salesphx@std-wire.com



Index

Symbols

10-Base-T 14, 22

A

abrasion resistant 42, 67, 70, 72-73, 76-77, 152-153, 160, 166, 174-176
adhesive and mastic tapes 151
adhesive cable clamp 181
adhesive cable clip 181
adhesive cable tie mount 183
adhesive ribbon cable clamp 181
air plenum 18-27, 29, 32, 187, 189-190
 breakout cables 190
 coaxial cable 29
 distribution cables 189
 inside telephone multi-pair
 Category 1 overall shield 21
 Category 1 unshielded pairs 20-21
 Category 3 unshielded pairs 22
 Category 4 unshielded pairs 23
 Category 5 overall shield 25
 Category 5 unshielded pairs 24
National Electric Code 32
overall shield 21, 25
shielded fire alarm cable 27
shielded multi-conductor 19-20
shielded pairs 26
simplex & duplex cables 187
sound and intercom shielded pairs 26
unshielded fire alarm cable 26
unshielded multi-conductor 18
unshielded pairs 20-24
alarm and security cables 2-4
 burglar alarm 2
 unshielded multi-conductor 2-4
amplitude modulation 184
ANSI X3T9.5 16-17, 24-25
antenna wire 69
appliance, fixture, apparatus, and motor lead wire 43
 SRML 43
appliance lead wire for high temperature 42
 TAGT 42
area conversions 178
area of (formula)
 circle 177

 parallelogram 177
 triangle 177
ASTM designation D-752 38
attenuation 108-109, 113-114, 141-150, 186
 M17/ 141-143
 RG 144-150
audio and data cable 7-9
 shielded multi-conductor 8-9
 shielded pairs 7
audio cable 1
audio systems 9, 18-20, 26
AWM 41

B

bandwidth 108, 184-186
bare solid soft drawn copper wire 51
baseband networks 31
bend radius 186
boot 151, 155-161
braid 50
braiding 115
breakout boots 151, 155, 159-161
breakout cables 190-191
 plenum 190
 riser 191
 UL type OFNP 190
 UL type OFNR 191
broadcast systems 9
brush leads 68
building interconnections 192-194
burglar alarm 1-4
business machine wire 41

C

cable and hose clamps 181
 adhesive cable clamp 181
 adhesive cable clip 181
 adhesive ribbon cable clamp 181
 cable clip 181
 coax cable clip 181
 push mount cable clamp 181
 ribbon cable clip 181
 siding clip 181
 snapper hose clamp 181
cable breakout boot 151, 155, 159-161

California

1959 East Cashdan Street, Rancho Dominguez, CA 90220
(310) 609-1811 • (800) 326-0006 • FAX: (310) 609-1862
E-Mail: salesrd@std-wire.com

Arizona

3120 West Thomas Road, Bldg. #801, Phoenix, AZ 85017
(602) 269-2501 • (800) 325-6478 • FAX: (602) 278-7134
E-Mail: salesphx@std-wire.com



Standard Wire & Cable Co.

- cable clamps 181
- cable clip 181
- cable design formulas
 - cabling factors 214
 - diameter of shield 215
 - percent of shield coverage 215
 - property values (nominal) 215
 - total weight of cabled conductor 214
 - twisting loss 215
 - weight of conductor 214
 - weight of insulation 214
 - weight of jacket 214
 - weight of shield 215
 - weight of tape 214
- cable end caps 151, 154
- cable entry seals 151
- cable harnessing systems 151
- cable jacket repair 151-153
- cable performance 186
- cable ties 183
 - adhesive cable tie mount 183
 - mounting cable ties 183
 - standard cable ties 183
- cabling factors formula 214
- Cal-Trans 34
- Cal-Trans loop detector lead-in cable 34
- capacitance 109, 110
- caps 151, 154
- Category 1 overall shield 13, 21
- Category 1 unshielded pairs 12, 20-21
- Category 3 unshielded pairs 14, 22
- Category 4 unshielded pairs 15, 23
- Category 5 overall shield 17, 25
- Category 5 unshielded pairs 16, 24
- CATV 28-30
- CCTV 28-30
- CDDI 16-17, 24-25
- chemical resistant 42-49
- circumference of circle formula 177
- CL2 1-9, 28, 30-32
- CL2P 18-20, 26, 29, 32
- CL2R 32
- CL2X 32
- CL3 2-9, 32
- CL3P 32
- CL3R 2-9, 32
- CL3X 32
- cladding 185
- Class H shielded & jacketed miniature cables 64-66
 - single conductor 64
 - two conductor 65
 - three conductor 65
 - four conductor 66
- CM 2-9, 12-17, 31-32
- CMP 20-25, 32
- CMR 12-17, 32
- CMX 32
- coaxial cable 28-31, 108, 150
 - % of rated power 113
 - air plenum 29
 - air-spaced 114
 - attenuation 108-109, 113-114, 141-150
 - M17/ 141-143
 - RG 144-150
 - bandwidth 108
 - braiding 115
 - cable clip 181
 - capacitance 109-110
 - CATV 28-30
 - CCTV 28-30
 - commercial type 28
 - cross-reference 139-140
 - cross talk 108
 - definitions 109
 - design formula 112
 - dielectric 112, 114-115
 - dielectric properties 112
 - frequency 109
 - frequency multiplexing 108
 - go wire 108, 112, 114-115
 - impedance 109, 112
 - inner conductors 110
 - jackets 112
 - M17 cable descriptions 116-124
 - manufacturing 115
 - outer conductors 111
 - power rating 113
 - precision video 31
 - primary dielectrics 111
 - protective coverings 112
 - return wire 108, 112, 114
 - RG legend 109
 - RG/U cable descriptions 125-138
 - spark tested 115
 - sweep test 115
 - swept 113
 - theory and application 108
 - thinnet 30
 - twinax cable 31
 - velocity of propagation 110
 - voltage standing wave ratio 114
 - VSWR 114

California

1959 East Cashdan Street, Rancho Dominguez, CA 90220
(310) 609-1811 • (800) 326-0006 • FAX: (310) 609-1862
E-Mail: salesrd@std-wire.com

Arizona

3120 West Thomas Road, Bldg. #801, Phoenix, AZ 85017
(602) 269-2501 • (800) 325-6478 • FAX: (602) 278-7134
E-Mail: salesphx@std-wire.com



cold resistant 43
color code charts 33
commercial heavy wall tubing 152
 joint and cable repair 152
commercial medium wall tubing 153
 XMTU/A 153
communication 10-11, 18-20, 26, 32, 48-49
communication & electronic control cords 36
comparison chart Mil Spec wires & cables 200
comparison chart UL wires & cables 195
computer hook-up wire 41
computer peripheral interconnection 31
computer room wiring 187-191
computer systems 18-20, 26
computerized instrumentation 109
contaminant resistant 153
control cable 44-49, 68
conversion tables and equivalencies
 area 178
 decimal equivalents of millimeters 178
 fractional inches & millimeters 178
 length 178
 temperatures 252-253
 volume 178
 weight 178
cords 35-39
 flexible 38-39
 retractile 35-37
core-cladding diameter ratio 186
corona resistant 43
corrosion resistant 152-153, 160-161, 165, 174
cross-linked modified ETFE 83-87
cross talk 108
CSA 40-41
 AWM 41
 TEW 40-41
 TR-64 40
cut-thru resistant 166, 174, 176

D

data cable 7-9
data grade UTP 15-17, 23-25
data processing 28-30
data recording 48-49
data trunk 192-194
decimal equivalents conversions 178, 251
Detecta-Duct® 34
detector loop wire 34
diameter of circle formula 177
diameter of shield formula 215
dielectric 112, 114-115

distribution cables 188-189
 plenum 189
 riser 188
 UL type OFNP 189
 UL type OFNR 188
DOD-2003-1 151, 159
duct 182-183
 fiber optic duct 183
 latch duct 182
 wiring duct 182
ducts between buildings 192-193
duplex 187
duplex cord 1

E

EIA/TIA TSB-36 Category 4 15, 23
EIA/TIA TSB-36 Category 5 16-17, 24-25
EIA/TIA-568 14, 22
electric welding cable 38
 Flexoprene® 38
electrical & electronic instrument wire 52-57
 jacketed 52-53
 shielded & jacketed 54-57
electronic control cords 36
electronic equipment 44-47
electronic wiring 40
encapsulation 165
environmental covers 151
Ethernet 14, 22
ethylene glycol resistant 67
excellent thermal stability 74-75
extruded Teflon® hook-up wire 58-60
 MIL-W-16878E/4 type E 58
 MIL-W-16878E/5 type EE 59
 MIL-W-16878E/6 type ET 60

F

FDDI 16-17, 24-25
fiber bandwidth 186
fiber optic cable 183-194
 breakout cables 190-191
 cable construction considerations 185
 cable performance 186
 distribution cables 188-189
 duct 183
 duplex cables 187
 error rates 184
 fiber types 185
 fundamental principle 185
 loose tube cables 192-194

California

1959 East Cashdan Street, Rancho Dominguez, CA 90220
(310) 609-1811 • (800) 326-0006 • FAX: (310) 609-1862
E-Mail: salesrd@std-wire.com

Arizona

3120 West Thomas Road, Bldg. #801, Phoenix, AZ 85017
(602) 269-2501 • (800) 325-6478 • FAX: (602) 278-7134
E-Mail: salesphx@std-wire.com



Standard Wire & Cable Co.

multi-mode graded-index 185
multi-mode step-index 185
optical characteristics 186
simplex cables 187
single-mode 185
systems components 184
theory and construction 184-186
transmission considerations 186
UL type OFNP 187, 189-190
UL type OFNR 187-188, 191-194
filled cable caps 151
filled loose buffer 186
filled loose tube 186
fire alarm cable 10-11, 26-27
 air plenum 26-27
 shielded 27
 sound and intercom shielded pairs 26
 unshielded 26
 parallel 10
 shielded multi-conductor 10
 unshielded multi-conductor 11
fire protection 32
fire resistant high temperature wire 72
flame resistant 42-49, 71, 73
flame-retardant 78-79, 81-82, 188-191
flexibility 1, 42, 76, 77, 81-82
flexible braid 50
flexible strand 68
 pigtail 68
Flexoprene® 35, 38
fluid resistant 67, 70, 72, 74-75
FP/polyimide/FP tape 88-95
FP tape 88-95
FPL 10-11, 32
FPL (R) 10-11
FPLP 26-27, 32
FPLR 32
fractional inches & millimeters conversions 178,
 251
frequency 109
frequency multiplexing 108
fuel resistant 166, 175-176
fungus resistant 40-41, 67, 71, 73-75
fusion splicing 184

G

general UL 1581 32
glossary of wire & cable terminology 216
go wire 108, 112, 114-115
grommets 151, 162-164
ground vehicle harnesses 176

H

harness repair 169
heat resistant 43, 73
heat shrinkable products 151-177, 179-180
 adhesive and mastic tapes 151
 cable breakout boot 151, 155, 159-161
 cable end caps 151, 154
 cable entry seals 151
 commercial heavy wall tubing 152
 commercial medium wall tubing 153
 grommets 151, 162-164
 heavy wall splice tubing - military/industrial OEM
 152
 HHW 152
 high-ratio grommets 151
 high-ratio sphincter ring 162-164
 medium/heavy wall tubing 151
 military heavy wall tubing 152
 military/industrial grade end caps 154
 motor connection kits 151
 ratio cable breakout boots 159
 ratio tubing 151
 recovered wall thickness 177
 shrink tube 151, 166-176
 shrink tube usage requirement table 179-180
 technical data & conversion tables 177
 transition boot 151, 155-158, 160-161
 very flexible sealing tape XTPA 080 165
 wrap around sleeves 151, 153
XHTU/A 152
XMTU/A 153
XTPA 080 165
XWSA 153
heavy duty harnessing 166
heavy wall polyolefin tubing 152
heavy wall splice tubing - military/industrial OEM 152
HHW 152
high breaking strength 81-82
high-ratio grommets 151
high-ratio sphincter ring 162-164
 size selection chart 164
high reliability 78-79, 81-82
high temperature 42, 70-72, 76-79, 81-82
high temperature applications 109
high temperature coaxial 109
high temperature resistant 71, 174-175
high tensile strength 69
hook-up wire 40-41, 52-53, 58-60
 MIL-W-16878/1 52
 MIL-W-16878/2 52
 MIL-W-16878/3 53

California

1959 East Cashdan Street, Rancho Dominguez, CA 90220
(310) 609-1811 • (800) 326-0006 • FAX: (310) 609-1862
E-Mail: salesrd@std-wire.com

Arizona

3120 West Thomas Road, Bldg. #801, Phoenix, AZ 85017
(602) 269-2501 • (800) 325-6478 • FAX: (602) 278-7134
E-Mail: salesphx@std-wire.com



Standard Wire & Cable Co.

MIL-W-16878E/4 Type E 58
MIL-W-16878E/5 Type EE 59
MIL-W-16878E/6 Type ET 60
MIL-W-16878/17 52
MIL-W-16878/18 52
MIL-W-16878/19 53
UL Style 1007, CSA TR-64 40
UL Style 1015, CSA TEW 40
UL Style 1028, CSA TEW 41
UL Style 1061, CSA AWM 41
horizontal cabling 14, 22
hose clamps 181
HRSR high-ratio sphincter ring 162-164

I

IEEE 802.3 14, 22, 30
IEEE 802.5 15, 23
impedance 109, 112
IMSA spec. no. 51-5 34
index of catalog numbers 260
index of refraction 185
indoor/outdoor installations 194
inductance detector loop wire 34
information systems 28-30
inside telephone multi-pair 12-17, 20-25
 air plenum 20-25
 Category 1 overall shield 21
 Category 1 unshielded pairs 20-21
 Category 3 unshielded pairs 22
 Category 4 unshielded pairs 23
 Category 5 overall shield 25
 Category 5 unshielded pairs 24
 Category 1 overall shield 13, 21
 Category 1 unshielded pairs 12, 20-21
 Category 3 unshielded pairs 14, 22
 Category 4 unshielded pairs 15, 23
 Category 5 overall shield 17, 25
 Category 5 unshielded pairs 16, 24
inside wiring 12-13, 20-21
instrument lead wire 27
instrument wire 52-57
 jacketed electrical & electronic 52-53
 shielded & jacketed electrical & electronic 54-57
instrumentation 3, 7-9, 109
instrumentation control cable 44-47
 overall shield 46-47
insulates crimped splices 168
insulation of cable harnessing 175
insulation of components 175
intercom cable 5-7
intercom systems 2-9, 18-19, 26

intercommunication set cord 68
interconnecting cables 2-4, 44-47
internal appliance wiring 40-41

J

jelly filled cables 154
joint and cable repair 152-153

K

kits 151

L

lamp cord 1
LAN 15-17, 23-25, 28-30
laser 184
latch duct 182
LED 184
length conversions 178
light-emitting diode 184
local area network 15-17, 23-25, 28-30
long haul networking 192-193
loop detector lead-in cable 34
loop detector wire 34
loose tube 186
loose tube cables 192-194
 indoor/outdoor 194
 outdoor 192-193
 UL type OFNR 192-94
low energy communication 10-11, 18-20, 26
low smoke emission 81-82
low-speed data applications 12-13, 20-21
low temperature resistant 43, 165
low voltage relay control systems 2-3
lubricant resistant 175

M

M17 cable descriptions 116
macro-bending 185
magnetic switches 68
mastic tapes 151
mathematical formulas
 area of circle 177
 area of parallelogram 177
 area of triangle 177
 circumference of circle 177
 diameter of circle 177
 surface area of sphere 177
 volume of prism or cylinder 177
 volume of pyramid or cone 177
 volume of sphere 177

California

1959 East Cashdan Street, Rancho Dominguez, CA 90220
(310) 609-1811 • (800) 326-0006 • FAX: (310) 609-1862
E-Mail: salesrd@std-wire.com

Arizona

3120 West Thomas Road, Bldg. #801, Phoenix, AZ 85017
(602) 269-2501 • (800) 325-6478 • FAX: (602) 278-7134
E-Mail: salesphx@std-wire.com



Standard Wire & Cable Co.

MATV 28-30	/11 79
mechanical protection 155, 160, 170, 175	/12 79
medium/heavy wall tubing 151	/16 80
Microminim® 27	/18 80
ultra-flex micro-miniature wire & cable 27	/20 81
MIL-C-13486 67	/21 81
Type I, Class A cable, special purpose, electrical	/22 82
67	/23 82
MIL-C-27500 cable designation 103-107	/32 83
MIL-I-23053 151, 166-176	/33 83
/1 (SWCPLD-100) 151, 166	/34 84
/4 (SWCPLDW-104) 151, 169	/35 84
/4 (SWCPLPW-100) 151, 168	/41 85
/4 (SWCPLSRDW-100) 151, 167	/42 85
/5 (SWCPLF-100) 151, 170	/43 86
/5 (SWCPLF-103) 151, 171	/44 86
/5 (SWCPLF-104) 151, 172	/45 87
/6 (SWCPLSR-100) 151, 173	/46 87
/8 (KYNAR®) 151, 174	/80A 88
/13 (VITON®) 151, 175	/81A 88
/16 (SWCPLD-101) 151, 176	/82A 89
MIL-I-81765 151-152, 154-163	/83A 89
/1 151-152, 154, 159-163	/84A 90
/1A 155-158	/85A 90
MIL-M-214519 151	/86A 91
MIL-W-3861 Type S 51	/87A 92
MIL-W-8777C (ASG) MS 25471 (ASG) 70	/88A 93
MIL-W-16878 52-63	/89A 94
/1 52	/90A 94
/2 52	/91A 95
/3 53	/92A 95
/4 58	supersession of duplicate strandings 61
/5 59	MIL-W-25038 72
/6 60	/1 72
/17 52	/3 72
/18 52	MIL-W-81044 96, 97
/19 53	/9 medium weight wall 96
cable designation 62-63	/12 lightweight wall 97
shielded & jacketed 54-57	/13 lightweight wall 97
supersession of duplicate strandings 61	MIL-W-81381 98-102
MIL-W-22759 61, 73-95	/7 98
/1 Class 1 200° C 73	/8 98
/2 Class 2 260° C 73	/9 99
/3 74	/11 99
/4 MS 90294 75	/12 100
/5 76	/13 100
/6 76	/17 101
/7 77	/21 101
/8 77	/22 102
/9 78	military ground vehicle harnesses 176
/10 78	military heavy wall tubing 152

California

1959 East Cashdan Street, Rancho Dominguez, CA 90220
 (310) 609-1811 • (800) 326-0006 • FAX: (310) 609-1862
 E-Mail: salesrd@std-wire.com

Arizona

3120 West Thomas Road, Bldg. #801, Phoenix, AZ 85017
 (602) 269-2501 • (800) 325-6478 • FAX: (602) 278-7134
 E-Mail: salesphx@std-wire.com



Standard Wire & Cable Co.

military/industrial grade end caps 154
 heat shrinkable end caps 154
 jelly filled cables 154
 terminating pipe and conduit 154
military specifications comparison chart 200
military vehicles 67
miniature cables 64-66, 68
 Class H 64-66
 flexible 68
minimum bend radius 186
moisture barrier 153
moisture resistant 40-49, 70-72, 74-75, 153, 165,
 192
monitoring 48-49
motor connection kits 151
mounting cable ties 183
MP 32
MPP 32
MPR 32
MS 25471 (ASG) 70
MS 27110 (ASG) 71
MS 90294 75
multi-mode graded-index 185
multi-mode step-index 185
multiple pair control cable, each pair shielded 48-49

N

National Electric Code 32
 CL2 32
 CL2P 32
 CL2R 32
 CL2X 32
 CL3 32
 CL3P 32
 CL3R 32
 CL3X 32
 CM 32
 CMP 32
 CMR 32
 CMX 32
 communications NEC 800 32
 fire protection NEC 760 32
 FPL 32
 FPLP 32
 FPLR 32
 general UL 1581 32
 MP 32
 MPP 32
 MPR 32
 multi-purpose NEC 800 32
 plenum UL 910 32

PLTC 32
 remote control NEC 725 32
 restricted residential 32
 riser UL 1666 32
navigation aids 109
Navsea Diagram No. 803-5001027 151, 160-161
NEC article 725 1-9, 18-20, 26, 28-32
NEC article 760 10-11, 26-27, 32
NEC article 800 2-9, 12-13, 20-21, 31-32
NEMA WC63 extended frequency specifications
 16-17, 24-25
NEMA WC63 low loss specifications 15, 23
Neoprene® portable flexible cord 39
 type SO 39
 types SVO & SJO 39
networks 31, 192-193
nonburning 80

O

office wiring 188-191
oil resistant 40-41, 44-49, 67, 72, 74-75, 166-176
optical waveguides 184
overload stability 78-79, 81-82
ozone resistant 43, 192

P

parallel speaker wire 1
patch cables 187
PBX systems 12-13, 20-21
percent of shield coverage formula 215
photodetector 184
pigtail 68
plenum 18-27, 29, 32, 187, 189-190
 UL 910 32
PLTC 32
polyolefin tubing 152
polyvinylchloride insulated UL/CSA hook-up wire
 40-41
 UL style 1007, CSA TR-64 40
 UL style 1015, CSA TEW 40
 UL style 1028, CSA TEW 41
 UL style 1061, CSA AWM 41
portable power cord 38-39
power cable 35
power cord - light duty 39
precision video 31
property values formula 215
protection in high temperature 174
protection of wire splices 173
PTFE/polyimide/PTFE 88

California

1959 East Cashdan Street, Rancho Dominguez, CA 90220
(310) 609-1811 • (800) 326-0006 • FAX: (310) 609-1862
E-Mail: salesrd@std-wire.com

Arizona

3120 West Thomas Road, Bldg. #801, Phoenix, AZ 85017
(602) 269-2501 • (800) 325-6478 • FAX: (602) 278-7134
E-Mail: salesphx@std-wire.com



Standard Wire & Cable Co.

public address systems 2-4
pulse dispersion 185
push mount cable clamp 181

Q

QQ-B-575 50
QQ-W-343 51

R

radar 109
radio 28-30, 109
ratio cable breakout boot 159
ratio tubing 151
recovered wall thickness conversion 177
refractive index 185
relays 68
remote control circuits 2-4, 32
remote signaling circuits 9
repair and rework of cable jackets 172
repairing cable jackets 153
resistance to
 abrasion 42, 67, 70, 72-73, 76-77, 152-153,
 160-161, 166, 174-176
 chemicals 42-49
 contaminants 153
 corona 43
 corrosion 152-153, 160-161, 165, 174
 cut-thru 166, 174, 176
 ethylene glycol 67
 fire 72
 flame 42-49, 71, 73, 78-79, 81-82
 fluids 67, 70, 72, 74-75
 fuels 166, 175-176
 fungus 40-41, 67, 71, 73-75
 heat 43, 73
 high temperatures 70-72, 76-79, 81-82, 174-175
 low temperatures 43, 165
 lubricants 175
 moisture 40-49, 70-72, 74-75, 153, 165, 192
 oils 40-41, 44-49, 67, 72, 74-75, 166, 176
 ozone 43, 192
 salt water 67
 solvents 40-41, 71, 74-75, 175
 tearing 152
 thermal cycling 43, 176
 ultraviolet radiation 43
 weather 67, 160-161, 192
retractile cords 35-37
 communication & electronic control cords 36
 Flexoprene® 35

heavy duty outdoor use 36
PVC communication & electronic control cords 36
shielded communications cords 37
test lead 37

return wire 108, 112, 114
rework of cable jackets 172
RG attenuation 144-150
RG legend 109
RG/U cable descriptions 125
ribbon cable clip 181
riser 32, 187-188, 191-194
 UL 1666 32
rubber portable flexible cord type SJ 38

S

safety control wiring 10-11, 18-20, 26
salt water resistant 67
sealing tape 165
 XTPA 080 165
seals 151
security cables 2-4
 burglar alarm 2
 unshielded multi-conductor 2-4
self-extinguishing 40-41, 80
shielded & jacketed elect. & electronic inst. wire
 54-57
 single conductor 54
 two conductor 55
 three conductor 56
 four conductor 57
shielded communications cords 37
shielded fire alarm cable 27
shielded multi-conductor 8-10, 19-20
shielded pairs 6-7, 17, 21, 25-26, 48-49
shielding 50
shipbuilding 109
short run office wiring 187
shrink tube 151-153, 166-180
 commercial heavy wall tubing 152
 commercial medium wall tubing 153
 MIL-I-23053/1 (SWCPLD-100) 166
 MIL-I-23053/4 (SWCPLDW-100) 168
 MIL-I-23053/4 (SWCPLDW-104) 169
 MIL-I-23053/4 (SWCPLSRDW-100) 167
 MIL-I-23053/5 (SWCPLF-100) 170
 MIL-I-23053/5 (SWCPLF-103) 171
 MIL-I-23053/5 (SWCPLF-104) 172
 MIL-I-23053/6 (SWCPLSR-100) 173
 MIL-I-23053/8 (KYNAR®) 174
 MIL-I-23053/13 (VITON®) 175
 MIL-I-23053/16 (SWCPLD-101) 176

California

1959 East Cashdan Street, Rancho Dominguez, CA 90220
(310) 609-1811 • (800) 326-0006 • FAX: (310) 609-1862
E-Mail: salesrd@std-wire.com

Arizona

3120 West Thomas Road, Bldg. #801, Phoenix, AZ 85017
(602) 269-2501 • (800) 325-6478 • FAX: (602) 278-7134
E-Mail: salesphx@std-wire.com



Standard Wire & Cable Co.

military heavy wall tubing 152
usage requirements table 179-180
shunt leads 68
siding clip 181
signal cable 68
signal loss 109
simplex & duplex cables 187
 plenum 187
 riser 187
 UL type OFNP 187
 UL type OFNR 187
single-mode 185
SJ 38
SJO 35, 39
sleeves 151, 153
slotted core 186
snapper hose clamp 181
SO 35, 39
solvent resistant 40-41, 71, 74-75, 175
sound and intercom cable 5-7, 26
 shielded pairs 6, 26
 unshielded solid pairs 7
 unshielded stranded pairs 5
sound systems 5-9
spark tested 115
speaker cable 1
speaker wire 1
special purpose miniature flexible cables 68
sphincter ring 162-164
spiralwrap 182
splice protection 169
SPT zip cord 1
SRML 43
standard cable ties 183
Stanflex® 69
strain relief 155, 162-163, 167-174
stripability 42
surface area of sphere formula 177
surface installation 2
SVO 35, 39
SWCPLD-100 166
SWCPLD-101 176
SWCPLDW-100 168
SWCPLDW-104 169
SWCPLF-100 170
SWCPLF-103 171
SWCPLF-104 172
SWCPLSR-100 173
SWCPLSRDW-100 167
sweep test 115

T

TAGT 42
TAGT/TGGT 42
tamper proof cover for wire markers 168
tape 151, 165
tearing resistant 152
technical data & conversion tables 177-178,
252-253
 area 178
 conversion tables and equivalencies 178
 decimal equivalents of millimeters 178
 fractional inches & millimeters 178
 length 178
 mathematical formulas 177
 recovered wall thickness 177
 temperature conversions 177, 252-253
 volume 178
 weight 178
Tefzel® 80
telecommunications 192-194
telemetry 44-49
telephone station wire 2
television 31, 109
temperature conversions 177, 252-253
terminating pipe and conduit 154
test lead 37, 69
 retractile cords 37
 Stanflex® 69
TEW 40-41
TGGT 42
thermal/cryogenic performance 80
thermal cycling resistant 43, 176
thermal stability 74-75
thermoplastic adhesive liner 168
thermoplastic adhesive tape 165
thinnet 30
tight buffer 186
tinned copper flexible braid 50
tinned solid soft drawn copper wire 51
token ring 15-17, 23-25
total internal reflection 185
TP-PMD 16-17, 24-25
TPDDI 16-17, 24-25
TR-64 40
trademarks 259
traffic signal 8
traffic signal cable 34
 Cal-Trans loop detector lead-in cable 34
 Detecta-Duct® 34
 inductance loop detector wire 34

California

1959 East Cashdan Street, Rancho Dominguez, CA 90220
(310) 609-1811 • (800) 326-0006 • FAX: (310) 609-1862
E-Mail: salesrd@std-wire.com

Arizona

3120 West Thomas Road, Bldg. #801, Phoenix, AZ 85017
(602) 269-2501 • (800) 325-6478 • FAX: (602) 278-7134
E-Mail: salesphx@std-wire.com



Standard Wire & Cable Co.

traffic signal induction detector loop wire 34
transition boot 151, 155-158, 160-161
 cable breakout 160-161
 low profile 157
 ratio cable 159
 right angle 156
 strain relief & boots for harness systems 155
 with lip 158
tubed loop wire 34
tubing 151-153, 166-176
twinax cable 31
twisting loss 215
two-way radio 28-30
type B to MIL-W-16878D 44-47, 52
type B/nylon 600 volt 52, 54-57
type C 1000 volt 52
type C/nylon 1000 volt 52, 54-57
type D 3000 volt 53
type D/nylon 3000 volt 53-57
type SJ 38
type SJO 35, 39
type SO 35, 39
type SVO 35, 39

U

UL 224 168
UL 910 32
UL 1354 28
UL 1478 28
UL 1581 32
UL 1666 32
UL 2106 8
UL style 1007, CSA TR-64 40
UL style 1015, CSA TEW 40
UL style 1028, CSA TEW 41
UL style 1061, CSA AWM 41
UL type OFNP 187, 189-190
UL type OFNR 187, 188, 191-194
UL wires & cables comparison chart 195
ultra-flex micro-miniature wire & cable 27
ultraviolet resistant 43
underwater sound 109
unshielded fire alarm cable 26
unshielded multi-conductor 2-4, 11, 18
unshielded pairs 5, 7, 12, 14-16, 20-24
 solid 5, 7, 12, 14-16, 20-24
 stranded 5
UTP 14-17, 22-25

V

velocity of propagation 110
very flexible sealing tape XTPA 080 165
video signal transmission 31
voice and low-speed data applications 12-13, 20-21
voltage standing wave ratio 114
volume conversions 178
volume of (formula)
 prism or cylinder 177
 pyramid or cone 177
 sphere 177
VSWR 114
VW-1 Vertical Flame Test 40

W

water tightness 160
waveguiding 184
weather resistant 67, 160, 192
weight conversions 178
weight of (formula)
 cabled conductor 214
 conductor 214
 insulation 214
 jacket 214
 shield 215
 tape 214
welding cable 38
wire bundling 170
wire data
 solid bare copper 254-255
 stranded tinned copper 256-258
wire for high temperature use 70-71, 76-79, 81-82
wire markers 170
wiring duct 182
wrap around sleeves 151, 153
 repairing cable jackets 153
 XWSA 153

X

XHTU/A 152
XMTU/A 153
XTPA 080 165
XWSA 153

California

1959 East Cashdan Street, Rancho Dominguez, CA 90220
(310) 609-1811 • (800) 326-0006 • FAX: (310) 609-1862
E-Mail: salesrd@std-wire.com

Arizona

3120 West Thomas Road, Bldg. #801, Phoenix, AZ 85017
(602) 269-2501 • (800) 325-6478 • FAX: (602) 278-7134
E-Mail: salesphx@std-wire.com

TERMS AND CONDITIONS

The following terms and conditions shall apply to all goods and services sold unless otherwise agreed to by Standard Wire & Cable Co. in writing:

Terms: 1% 10, net 30 days upon approved credit.

Minimum Order: Our minimum order is \$100.00 U.S. combined material value.

Order Quantities. Material quantities ordered are subject to a shipping and billing tolerance of plus or minus 10%.

Payment: All payments must be made within Standard Wire & Cable Co.'s terms and in good funds in U.S. dollars and will be deemed made when such funds are received by Standard Wire & Cable Co. VISA and MasterCard are also accepted on domestic orders.

Export: All foreign orders are either payable in advance or by letter of credit unless an open account has been established with credit approval.

Freight Policy: FOB Rancho Dominguez, California (U.S.A.) or Phoenix, Arizona (U.S.A.).

Warranty: Standard Wire & Cable Co.'s products are warranted to be free from defects in material and workmanship at the time of sale. Standard Wire & Cable Co.'s obligation under this warranty is strictly limited to the replacement of the product. Under no circumstances is Standard Wire & Cable Co. liable for any loss, damage, expenses, or consequential damage of any kind arising out of the use or inability to use these products. Standard Wire & Cable Co. makes no warranty as to the fitness or suitability of any goods or services for buyer's particular use.

Returned Goods: No return may be made unless Standard Wire & Cable Co. has issued a Return Material Authorization (RMA) to the buyer prior to the return. As a condition of accepting any such return, Standard Wire & Cable Co. may require that the original packaging materials accompany the goods at the time of return.

Technical Assistance: We will be pleased to supply technical assistance in providing you with the most cost-effective solution to your wire and cable requirements.

Copyright: This catalog supersedes all previous Standard Wire & Cable Co. publications and is copyrighted. All reproduction rights are reserved.

No part of this Technical Handbook and Catalog may be reproduced without the express written consent of Standard Wire & Cable Co.