

Exhibit F – Test Report

TABLE OF CONTENTS

EXHIBIT F – TEST REPORT 1

TABLE OF CONTENTS..... 1

1. TRANSMITTER PERFORMANCE TESTS – EXHIBIT I 3

1.1 RF POWER OUTPUT 3

1.1.1 REQUIREMENTS 3

1.1.2 TEST PROCEDURE 4

1.1.3 TEST RESULTS..... 4

1.1.4 POWER OUTPUT DATA SHEET 5

1.1.5 RF LOAD CHARACTERISTICS..... 6

1.1.6 SMITH CHARTS 7

1.2 MODULATION CHARACTERISTICS..... 8

1.2.1 REQUIREMENTS 8

1.2.2 TEST PROCEDURE 8

1.2.3 TEST RESULTS..... 9

1.3 OCCUPIED BANDWIDTH 15

1.3.1 REQUIREMENTS 15

1.3.2 TESTS FOR TYPE 5K00A3E EMISSIONS 16

1.3.3 TESTS FOR TYPE 10K0A3D EMISSIONS 21

1.3.4 TESTS FOR TYPE 14K0G1DE EMISSIONS 23

1.3.5 TESTS FOR TYPE 14K0G7WET EMISSIONS 24

1.4 SPURIOUS EMISSIONS AT ANTENNA TERMINAL 25

1.4.1 REQUIREMENTS 25

1.4.2 TEST PROCEDURE 26

1.4.3 TEST RESULTS..... 26

1.5 FIELD STRENGTH OF SPURIOUS RADIATION 30

1.5.1 REQUIREMENTS 30

1.5.2 TEST PROCEDURE 31

1.5.3 TEST RESULTS..... 31

1.6	FREQUENCY STABILITY	32
1.6.1	REQUIREMENTS	32
1.6.2	TEST PROCEDURE	33
1.6.3	TEST RESULTS.....	34

1. TRANSMITTER PERFORMANCE TESTS – EXHIBIT I

This section documents the test procedures used, and records the results of tests to demonstrate compliance with the applicable requirements of parts 2 and 87 of the FCC Rules and Regulations.

1.1 RF POWER OUTPUT

1.1.1 REQUIREMENTS

FCC Sec. 2.1046

Measurements required: RF power output.

(a) For transmitters other than single sideband, independent sideband and controlled carrier radiotelephone, power output shall be measured at the RF output terminals when the transmitter is adjusted in accordance with the tune-up procedure to give the values of current and voltage on the circuit elements specified in Sec. 2.1033(c)(8). The electrical characteristics of the radio frequency load attached to the output terminals when this test is made shall be stated.

FCC 87.131

Power must be determined by direct measurement. The following lists authorized emissions and maximum power.

Class of Station	Frequency Band	Emissions	Power
Aircraft (Communications)	VHF	A3E, A9W	55 w

The power is measured at the transmitter output terminals and the type of power is determined according to the emission designator as follows:

Mean power (pY) for amplitude modulated emissions and transmitting both sidebands using unmodulated full carrier.

Power is restricted to the minimum necessary to achieve the required service.

1.1.2 TEST PROCEDURE

The VHF-2100 was adjusted in accordance with the tune-up instructions. Primary power supply was set to 27.5 VDC. Unmodulated carrier power was measured at carrier frequency intervals beginning at 118.000 MHz.

The RF load for these measurements was a 30 dB attenuator. Power in AM mode was measured with an HP435B Power Meter. Power for Mode 2 and Mode 3 was measured with a Gigatronics 8542C power meter with 80401A sensor. The characteristics of the attenuator were measured with an HP8753C network analyzer and 856046A S-Parameter test set. A plot of the Smith Chart display, from 118 to 137 MHz, follows the power data, and shows that the load is essentially 50 ohms resistive over this frequency range. The scale of the SWR plot is 1:1 at the bottom, with each vertical division .05 SWR, i.e., the first division up from the bottom is 1.05:1.

1.1.3 TEST RESULTS

The data sheet that follows shows power measurements across the band covered by this transmitter. The power level is the same for 25 kHz channels as it is for 8.33 kHz channels. Part 87 of the FCC Rules does not define a maximum authorized power. The measured power output is typical of that provided in VHF transceivers for Air Transport aircraft.

The second column of the data sheet which follows is from tests on the VHF-2100 in digital data VDL Mode 2 and shows power measurements across the band covered by this transmitter. The measured power output is typical of that provided in VHF transceivers for commercial aircraft for VDL Mode 2 operations.

The third column of the data sheet which follows is from tests on the VHF-2100 in VDL Mode 3 and shows power measurements across the band covered by this transmitter. The measured power output is typical of that provided in VHF transceivers for commercial aircraft for VDL Mode 3 operations.

1.1.4 POWER OUTPUT DATA SHEET

Type Number: VHF-2100	Serial Number:18J9V
Date Tested:11/19/03	Tested by:J.CHETWYND

Frequency	Analog Voice Tx Power Output	Mode 2 Tx Power Output	Mode 3 Tx Power Output
118.000 MHz	31.3 Watts	20.5 Watts	20.4 Watts
122.000 MHz	32.2 Watts	20.3 Watts	20.7 Watts
125.000 MHz	31.9 Watts	20.4 Watts	20.5 Watts
129.000 MHz	31.7 Watts	20.6 Watts	20.5 Watts
131.000 MHz	31.6 Watts	20.5 Watts	21.0 Watts
133.000 MHz	31.6 Watts	20.2 Watts	20.8 Watts
136.975 MHz	29.9 Watts	18.9 Watts	19.5 Watts

1.1.5 RF LOAD CHARACTERISTICS

Frequency (MHz)	RF Load VSWR
118.000	1.05:1
122.000	1.05:1
125.000	1.05:1
129.000	1.05:1
131.000	1.05:1
133.000	1.05:1
136.975	1.05:1

1.1.6 VSWR AND SMITH CHART PLOTS

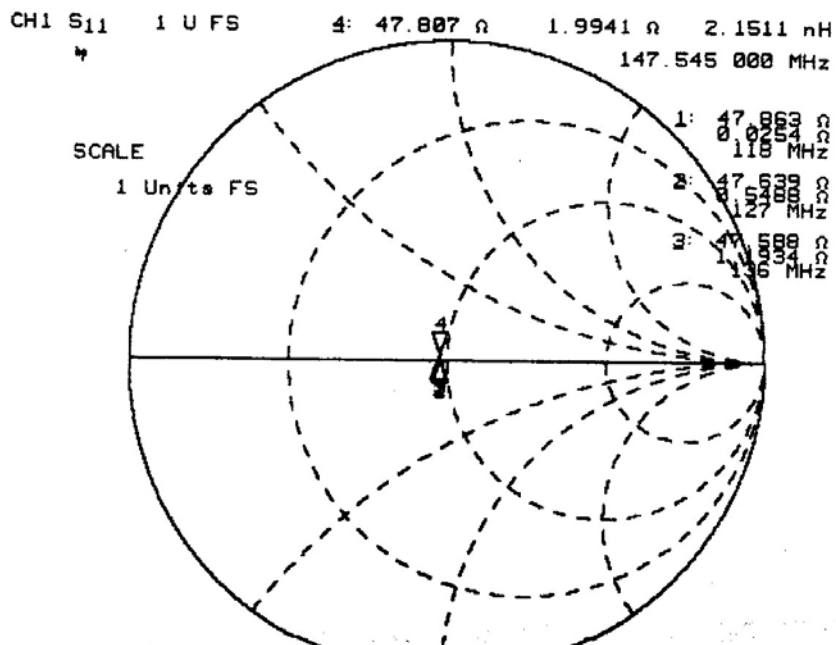
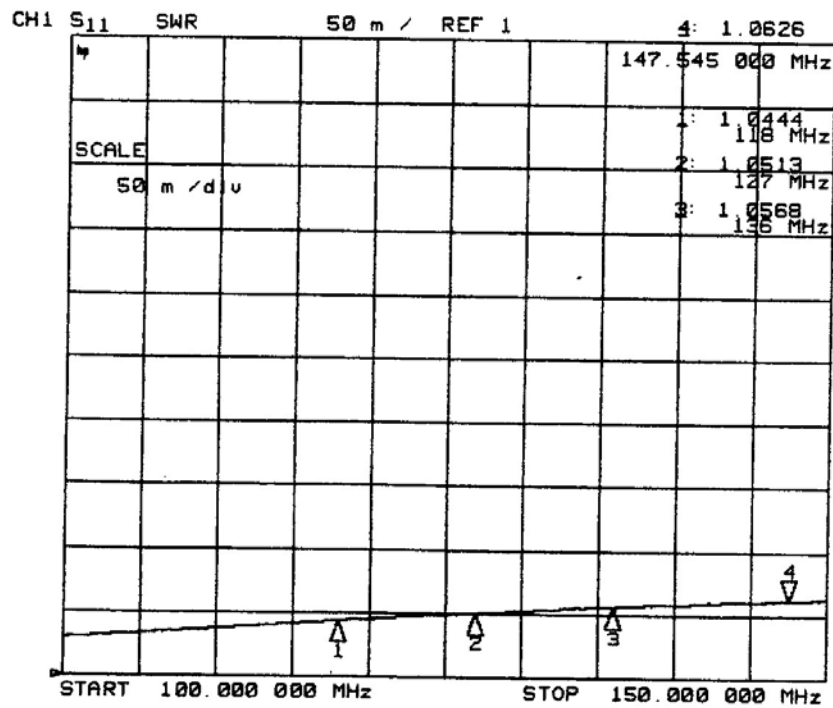

1.2 MODULATION CHARACTERISTICS

1.2.1 REQUIREMENTS

FCC Sec. 2.1047

Measurements required: Modulation characteristics.

(a) Voice modulated communication equipment. A curve or equivalent data showing the frequency response of the audio modulating circuit over a range of 100 to 5000 Hz shall be submitted. For equipment required to have an audio low-pass filter, a curve showing the frequency response of the filter, or of all circuitry installed between the modulation limiter and the modulated stage shall be submitted.

(b) Equipment which employs modulation limiting. A curve or family of curves showing the percentage of modulation versus the modulation input voltage shall be supplied. The information submitted shall be sufficient to show modulation limiting capability throughout the range of modulating frequencies and input modulating signal levels employed.

FCC Sec. 87.141

Modulation requirements

(a) When A3E emission is used, the modulation percentage must not exceed 100 percent. This requirement does not apply to emergency locator transmitters or survival craft transmitters.

(b) A double sideband full carrier amplitude modulated radiotelephone transmitter with rated carrier power output exceeding 10 Watts must be capable of automatically preventing modulation in excess of 100 percent.

1.2.2 TEST PROCEDURE

Frequency Response Data

The audio generator is set to 1000 Hz, and its level adjusted to 0.25 Vrms. The transmitter modulation was adjusted to produce 90% modulation on the 25 kHz channels and 85% modulation on the 8.33 kHz channels. While maintaining this input level, the modulation depth is recorded over the frequency range of 100 Hz to 5000 Hz. All data measurements were taken with an HP8901A Modulation Analyzer.

Compression Characteristic Data

Next, with audio generator set to 1000 Hz, the modulation depth was recorded for audio generator output levels over the range of 10 mVrms to 1.0 Vrms. This procedure was repeated at modulating frequencies of 100 Hz, 350 Hz, 2500 Hz, and 5000 Hz.

1.2.3 TEST RESULTS

The data following represents the results of these measurements of modulation frequency response and compressor limiting characteristics on the VHF-2100.

Type Number:	VHF-2100	Serial Number:	18J9V
Date Tested:	11/10/03	Tested by:	J.CHETWYND

Frequency Response Data

	<u>25 KHz Channel, 126.600 MHz</u>		<u>8.33 KHz Channel, 126.500 MHz</u>	
Frequency (Hz)	Modulation Depth (%)	Relative Response (dB)	Modulation Depth (%)	Relative Response (dB)
100	10.6	-19.4	10.3	-19.4
350	71.8	-1.83	71.8	-1.82
600	82.0	-.63	82.0	-.65
1000	88.0	0 REF	88.0	0 REF
1500	84.4	-.42	84.3	-.43
2000	82.0	-.68	82.0	-.68
2500	75.4	-1.42	75.4	-1.42
3000	6.0	-22.4	6.0	-22.8
4000	.40	-52.5	.40	-52.6
5000	.40	-52.5	.40	-52.6

Compression Characteristic Data

Frequency: 100 Hz

	<u>25 KHz Channel, 126.500 MHz</u>	<u>8.33 KHz Channel, 126.500 MHz</u>
Input Level (mVrms)	Modulation Depth (%)	Modulation Depth (%)
10	.70	.80
20	1.20	1.20
30	1.70	1.70
40	2.10	2.20
60	3.10	3.10
80	4.0	4.0
100	5.10	5.10
150	7.60	7.60
300	10.0	10.1
600	10.0	10.1
1000	10.0	10.1

Frequency: 350 Hz

	<u>25 KHz Channel, 126.500 MHz</u>	<u>8.33 KHz Channel, 126.500 MHz</u>
Input Level (mVrms)	Modulation Depth (%)	Modulation Depth (%)
10	5.8	5.7
20	10.8	10.8
30	15.9	15.9
40	20.8	20.7
60	31.5	31.5
80	41.9	41.9
100	52.0	52.1
150	71.6	71.6
300	71.8	71.9
600	71.8	71.8
1000	71.8	71.9

Frequency: 600 Hz

	<u>25 KHz Channel, 126.500 MHz</u>	<u>8.33 KHz Channel, 126.500 MHz</u>
Input Level (mVrms)	Modulation Depth (%)	Modulation Depth (%)
10	6.5	6.5
20	12.3	12.5
30	18.0	18.2
40	23.7	23.8
60	36.0	36.1
80	48.0	48.1
100	59.4	59.5
150	81.6	81.7
300	81.7	81.8
600	81.8	81.8
1000	81.7	81.8

Frequency: 1000 Hz

	<u>25 KHz Channel, 126.500 MHz</u>	<u>8.33 KHz Channel, 126.500 MHz</u>
Input Level (mVrms)	Modulation Depth (%)	Modulation Depth (%)
10	6.7	6.7
20	12.4	12.6
30	18.3	18.3
40	24.1	24.2
60	36.3	36.5
80	48.5	48.8
100	60.2	60.4
150	88.0	88.1
300	88.0	88.2
600	88.0	88.2
1000	88.0	88.2

Frequency: 2000 Hz

	<u>25 KHz Channel, 126.500 MHz</u>	<u>8.33 KHz Channel, 126.500 MHz</u>
Input Level (mVrms)	Modulation Depth (%)	Modulation Depth (%)
10	5.2	5.2
20	9.5	9.5
30	14.0	14.1
40	18.3	18.3
60	27.6	27.7
80	36.8	36.7
100	45.5	45.6
150	67.6	67.7
300	81.9	81.9
600	81.9	82.0
1000	82.0	82.0

Frequency: 3000 Hz

	<u>25 KHz Channel, 126.500 MHz</u>	<u>8.33 KHz Channel, 126.500 MHz</u>
Input Level (mVrms)	Modulation Depth (%)	Modulation Depth (%)
10	.60	.60
20	.90	.90
30	1.2	1.2
40	1.4	1.4
60	2.2	2.2
80	2.7	2.7
100	3.3	3.3
150	4.8	4.8
300	6.6	6.5
600	6.5	6.4
1000	6.5	6.4

Frequency: 4000 Hz

	<u>25 KHz Channel, 126.500 MHz</u>	<u>8.33 KHz Channel, 126.500 MHz</u>
Input Level (mVrms)	Modulation Depth (%)	Modulation Depth (%)
10	.30	.30
20	.30	.30
30	.30	.30
40	.40	.30
60	.20	.30
80	.40	.30
100	.30	.30
150	.30	.30
300	.20	.20
600	.10	.20
1000	.10	.10

Frequency: 5000 Hz

	<u>25 KHz Channel, 126.500 MHz</u>	<u>8.33 KHz Channel, 126.500 MHz</u>
Input Level (mVrms)	Modulation Depth (%)	Modulation Depth (%)
10	.30	.30
20	.30	.30
30	.30	.30
40	.30	.30
60	.30	.30
80	.30	.30
100	.30	.30
150	.30	.30
300	.20	.30
600	.20	.20
1000	.10	.20

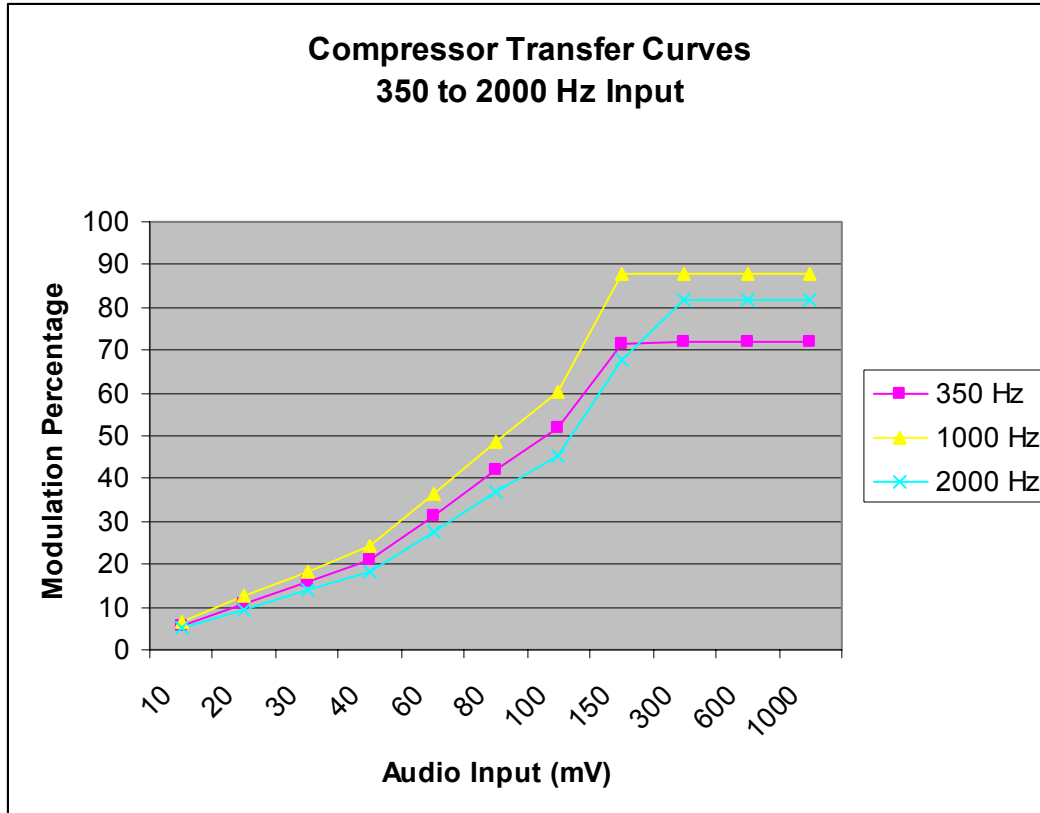

1.3 OCCUPIED BANDWIDTH

1.3.1 REQUIREMENTS

FCC Sec. 2.1049

Measurements required: Occupied bandwidth.

The occupied bandwidth, that is the frequency bandwidth such that, below its lower and above its upper frequency limits, the mean powers radiated are each equal to 0.5 percent of the total mean power radiated by a given emission shall be measured under the following conditions as applicable:

(c) Radiotelephone transmitters equipped with a device to limit modulation or peak envelope power shall be modulated as follows. For single sideband and independent sideband transmitters, the input level of the modulating signal shall be 10 dB greater than that necessary to produce rated peak envelope power.

(1) Other than single sideband or independent sideband transmitters--when modulated by a 2500 Hz tone at an input level 16 dB greater than that necessary to produce 50 percent modulation. The input level shall be established at the frequency of maximum response of the audio modulating circuit.

FCC Sec. 87.135

Bandwidth of emission.

(a) Occupied bandwidth is the width of a frequency band such that, below the lower and above the upper frequency limits, the mean powers emitted are each equal to 0.5 percent of the total mean power of a given emission.

(b) The authorized bandwidth is the maximum occupied bandwidth authorized to be used by a station.

(c) The necessary bandwidth for a given class of emission is the width of the frequency band which is just sufficient to ensure the transmission of information at the rate and with the quality required under specified conditions.

FCC 87.137

In the band, 117.975-136 MHz, the authorized bandwidth is 25 KHz for all transmitter type accepted after 1 January 1974.

1.3.2 TESTS FOR TYPE 5K00A3E EMISSIONS

The VHF-2100 is capable of 5K00A3E emissions on 25 kHz and 8.33 KHz spaced channels. The following tests demonstrate the occupied bandwidth for 25 kHz and 8.33 KHz channels is less than 25 KHz. The following test demonstrates the occupied bandwidth for 8.33 KHz channel operation is less than 8.33 KHz. It also demonstrates that operation on 8.33 KHz channels will have an occupied bandwidth of less than or equal to 5.0 KHz.

1.3.2.1 TEST PROCEDURE

With the radio tuned to 126.5 MHz (25 kHz channel) and at the frequency of maximum response, the audio input level required to produce 50% modulation was determined by temporarily substituting a modulation analyzer for the spectrum analyzer (see test set-up below). The modulating frequency was then set to 2500 Hz, and the input level was 16 dB above that level determined above.

The transmitted spectrum was then displayed with resolution sufficient to resolve adjacent sidebands. The spectral data were recorded and converted to relative power levels. These data were then analyzed to determine the occupied bandwidth such that no more than 0.5 percent of the total radiated power occupied the spectrum above or below this band.

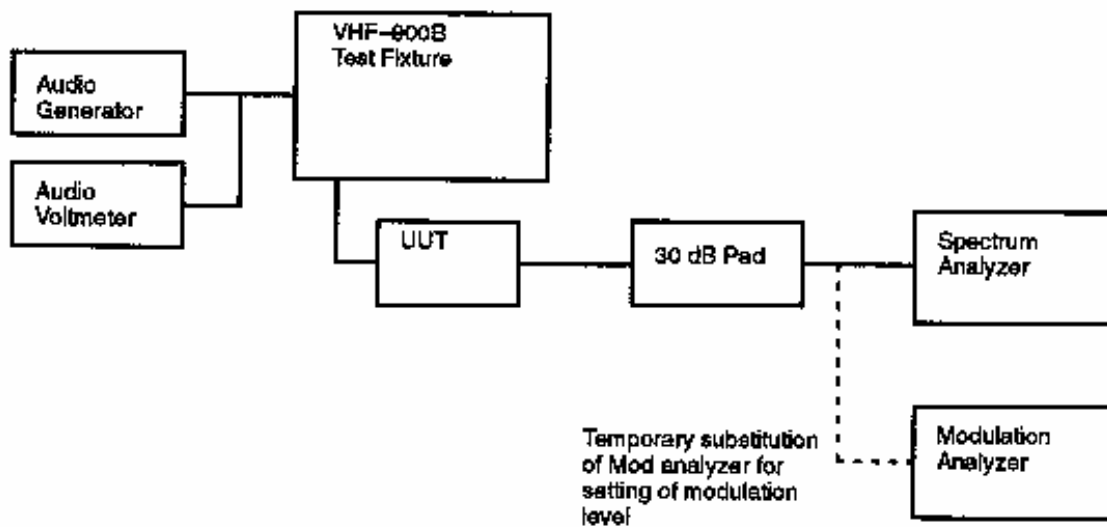

The test was repeated on 126.505 (8.33 kHz channel on 126.500 MHz) using modulating tones of 2500 Hz.

1.3.2.2 TEST RESULTS

The occupied bandwidth is 5 kHz. The plots shown below show the radiated spectrum. The data that follows also shows the measurements and calculations.

25 KHz channel & 2.5 KHz Mod tone

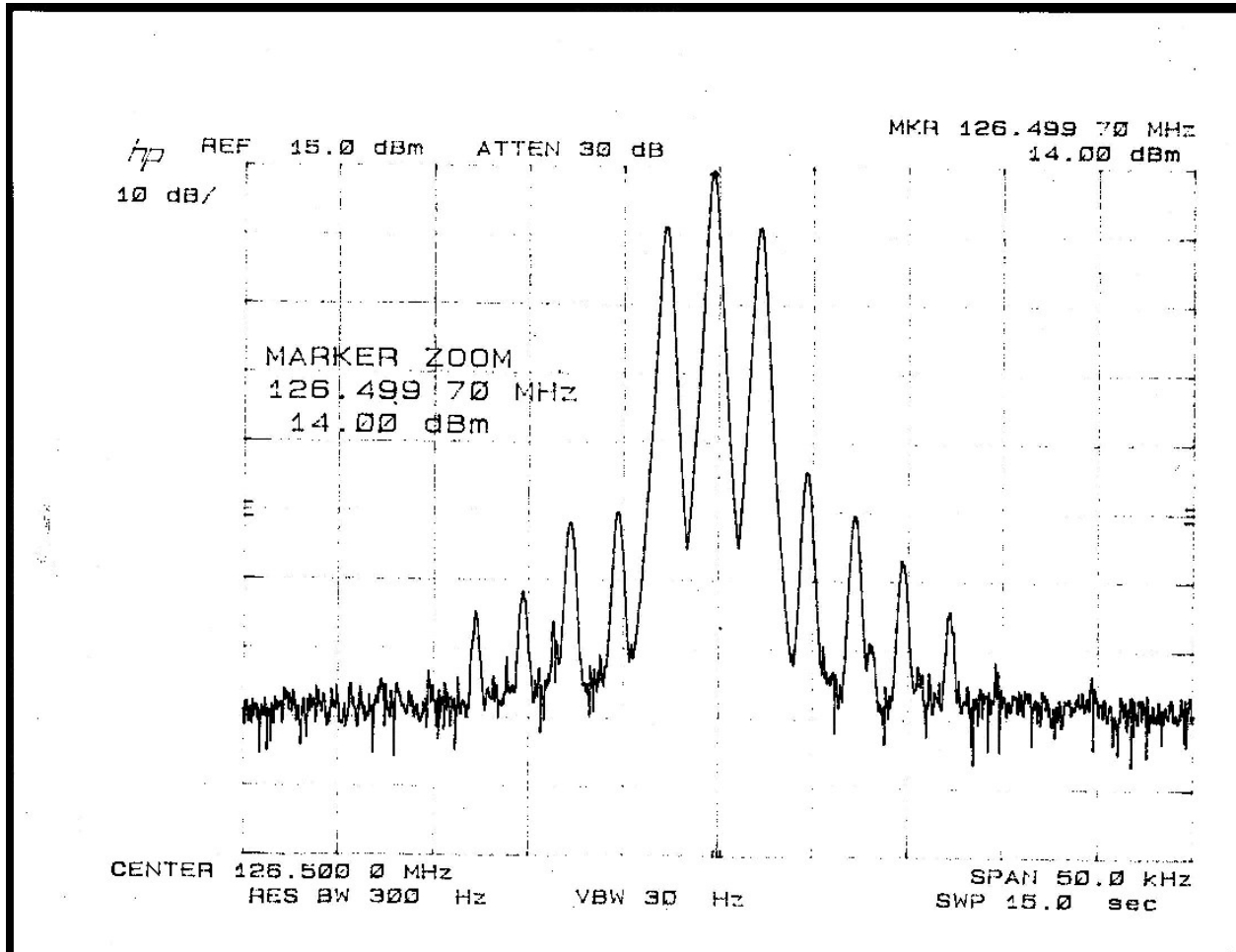

8.33 KHz channel & 2.5 KHz Mod tone

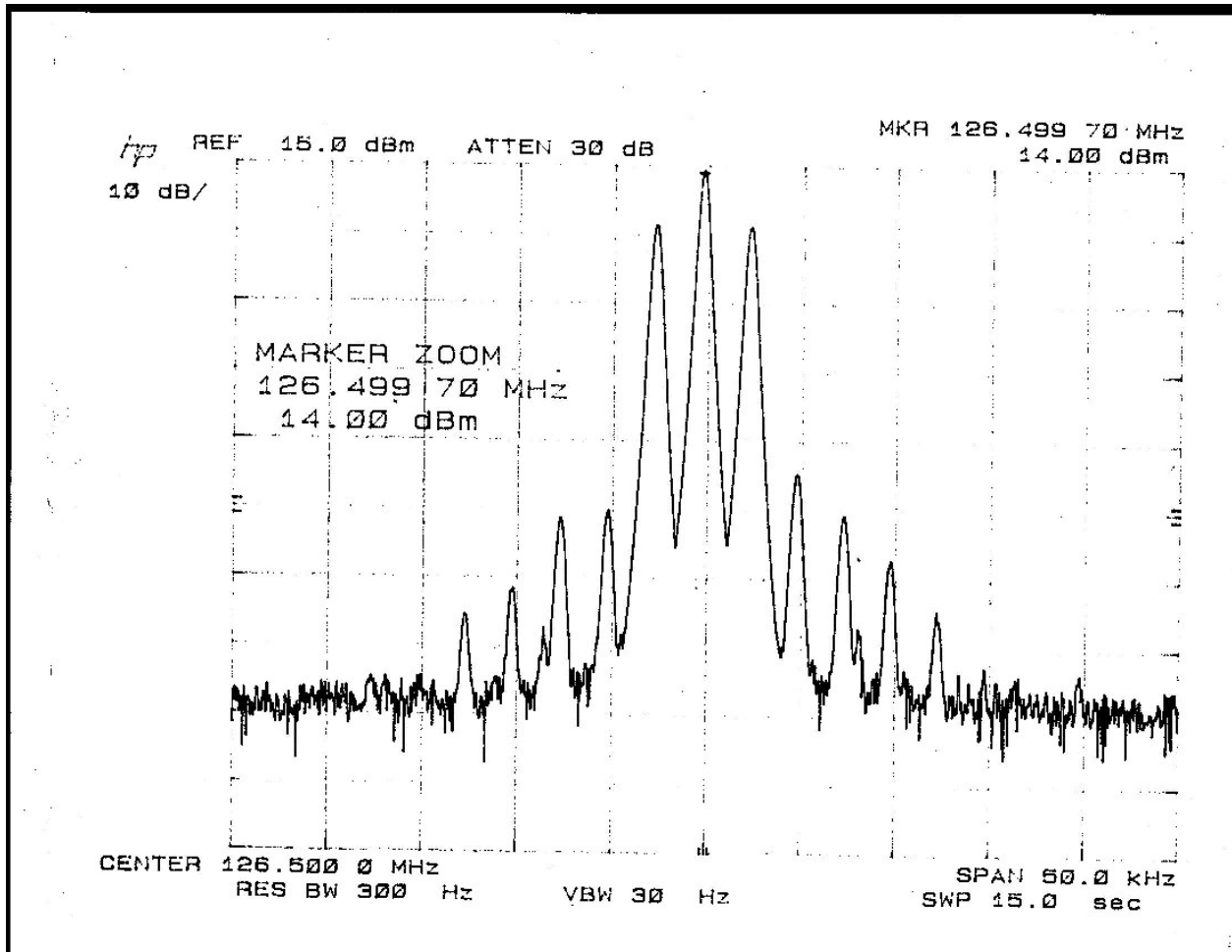

Occupied Bandwidth Data Sheet

Type Number: VHF-2100		Serial Number: 18J9V	
Date tested: 11/10/03		Tested by: J. CHETWYND	
25 KHz channel & 2.5 KHz Mod tone			
Carrier Power = 31.9 Watts		Frequency 126.500 MHZ	
Frequency (MHz)	Relative Level (dBc)	Absolute Power (Watts)	% Power
126.5125	-64.4	0.00	0.00
126.5100	-56.8	0.00	0.00
126.5075	-49.8	0.00	0.00
126.5050	-43.6	0.00	0.00
126.5025	-7.9	5.16	12.14
126.5000	0	31.84	74.85
126.4975	-7.6	5.53	13.01
126.4950	-49.4	0.00	0.00
126.4925	-50.8	0.00	0.00
126.4900	-61	0.00	0.00
126.4875	-66	0.00	0.00
Total Power = 42.54 Watts		0.5% of total power = 0.21 Watts	
Power over +/- 2.5 KHz = 42.54 Watts			
Percent of total power over \pm 2.5 KHz = 99.99 %			

Occupied Bandwidth Data Sheet

Type Number: VHF-2100		Serial Number: 18J9V	
Date tested: 11/10/03		Tested by: J. CHETWYND	
8.33 KHz channel & 2.5 KHz Mod tone			
Carrier Power = 31.9 Watts		Frequency 126.500 MHZ	
Frequency (MHz)	Relative Level (dBc)	Absolute Power (Watts)	% Power
126.5125	-63.4	0.00	0.00
126.5100	-56.6	0.00	0.00
126.5075	-50	0.00	0.00
126.5050	-43.7	0.00	0.00
126.5025	-7.9	5.16	12.14
126.5000	0	31.84	74.85
126.4975	-7.7	5.41	12.71
126.4950	-49.3	0.00	0.00
126.4925	-50.3	0.00	0.00
126.4900	-61	0.00	0.00
126.4875	-64.4	0.00	0.00
Total Power = 42.42 Watts		0.5% of total power = 0.21 Watts	
Power over +/- 2.5 KHz = 42.41 Watts			
Percent of total power over \pm 2.5 KHz = 99.98 %			

1.3.3 TESTS FOR TYPE 10K0A3D EMISSIONS

1.3.3.1 TEST PROCEDURE

A test generator simulating a standard Aviation Data MODEM (Collins Type DLM-700) was connected to the analog data terminals of the unit. This MODEM provides 2400 bits per second MSK data at a nominal 1 V RMS which is the specified nominal level for data audio into the VHF-2100. With continuous random data being transmitted from the ACARS MODEM, the transmitted spectrum was displayed. The spectral data were recorded and converted to relative power levels. These data were then analyzed to determine the occupied bandwidth such that no more than 0.5 percent of the total radiated power occupied the spectrum above or below this band.

1.3.3.2 TEST RESULTS

The occupied bandwidth is 5.775 KHz. The photo below shows the radiated spectrum. The vertical lines mark the region of the spectrum containing 99% of the power. The test instrument used for this measurement is an Agilent 89441A Vector Signal Analyzer. The bandwidth is determined by measuring the channel power after 30 dB of attenuation, converting to milliwatts, taking 99% and setting the channel markers until that power is contained. The data sheet that follows shows the measurement of each modulation sideband and calculations.

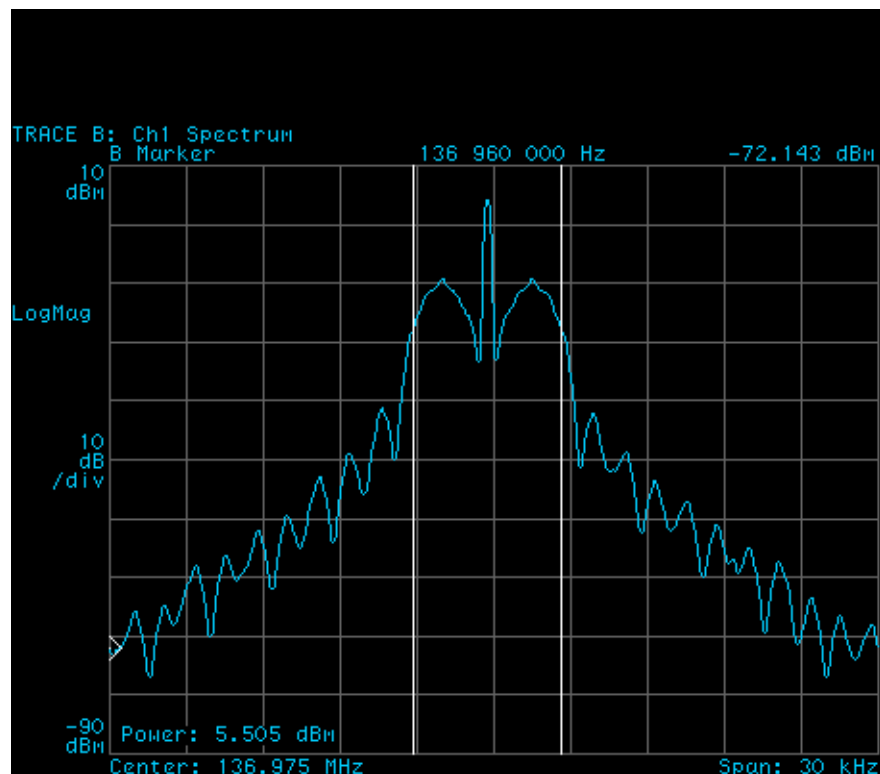

Occupied Bandwidth Data Sheet

Type Number: VHF-2100		Serial Number: 18J9V	
Date tested: 11/24/03		Tested by: J. CHETWYND	
25 KHz channel & Modulating using MODEM			
Carrier Power = 34 Watts		Frequency 126.500 MHZ	
Frequency (MHz)	Relative Level (dBc)	Absolute Power (Watts)	% Power outside ± 2.5 KHz
126.5125	-65.2	0.00	0.00
126.5100	-53.9	0.00	0.00
126.5075	-47.6	0.00	0.00
126.5050	-40.4	0.00	0.01
126.5025	-13.7	1.45	3.76
126.5000	0	34.00	88.18
126.4975	-10.4	3.10	8.04
126.4950	-42.6	0.00	0.00
126.4925	-49.1	0.00	0.00
126.4900	-55.0	0.00	0.00
126.4875	-66.3	0.00	0.00
Total Power = 38.56 Watts		0.5% of total power = 0.19 Watts	
Power over +/- 5 KHz = 38.55 Watts			
Percent of total power over +/- 5 KHz = 99.98 %			

1.3.4 TESTS FOR TYPE 14K0G1DE EMISSIONS

1.3.4.1 TEST PROCEDURE

The transceiver was configured to generate a repetitive burst transmission with a message of pseudo-random characters. The transmitted spectrum was then displayed. The spectral data were taken with an Agilent 89441A Vector signal analyzer. The power in a 25 kHz channel was measured in dBm with band power marker functions, the result converted to milliwatts, and a second set of markers set to determine the bandwidth containing 99% of the power.

1.3.4.2 TEST RESULTS

The photo below shows the radiated spectrum. The outer markers are the assigned 25 kHz channel, the inner markers show the limits for 99% of the power. The measured occupied bandwidth is 12.4 which is less than the declared 14 kHz bandwidth associated with the emission designator 14K0G1DE. The emission designator bandwidth was selected by VDL Mode 2 Industry committees at 14 kHz to allow for variances in bandwidth due to hardware and software implementations.

Type Number:	VHF-2100 VDL MODE 2	Serial Number: 18J9V	99% Bandwidth
Date Tested:	11/24/03	Tested by: GEC, RL	12.4 kHz

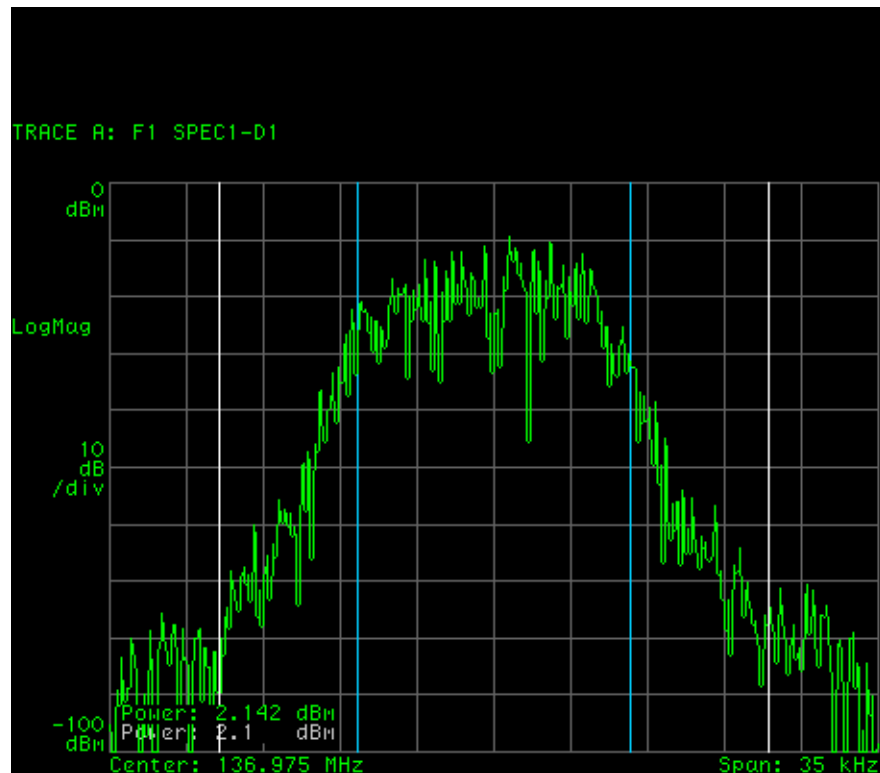

1.3.5 TESTS FOR TYPE 14K0G7WET EMISSIONS

1.3.5.1 TEST PROCEDURE

The transceiver was configured to generate a continuous transmission with random characters. With continuous random data being transmitted, the transmitted spectrum was displayed. The spectral data were taken with an Agilent 89441A Vector signal analyzer. The power in a 25 kHz channel was measured in dBm with band power marker functions, the result converted to milliwatts, and a second set of markers set to determine the bandwidth containing 99% of the power.

1.3.5.2 TEST RESULTS

The photo below shows the radiated spectrum. The outer markers are the assigned 25 kHz channel, the inner markers show the limits for 99% of the power. The measured occupied bandwidth is 12.1 kHz which is less than the declared 14 kHz bandwidth associated with the emission designator 14K0G7WET. The emission designator bandwidth was selected by VDL Mode 3 Industry committees at 14 kHz to allow for variances in bandwidth due to hardware and software implementations.

Type Number:	VHF-2100 VDL MODE 3	Serial Number: 18J9V	99% Bandwidth
Date Tested:	11/19/03	Tested by: GEC, RL	12.1 kHz

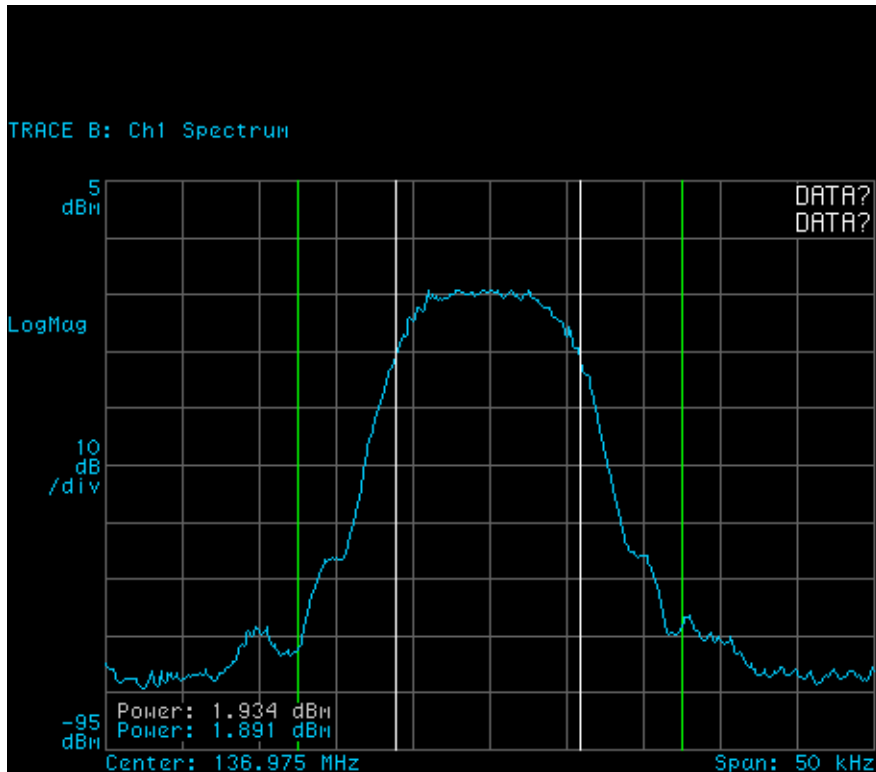

1.4 SPURIOUS EMISSIONS AT ANTENNA TERMINAL

1.4.1 REQUIREMENTS

FCC Sec. 2.1051

Measurements required: Spurious emissions at antenna terminals.

The radio frequency voltage or powers generated within the equipment and appearing on a spurious frequency shall be checked at the equipment output terminals when properly loaded with a suitable artificial antenna. Curves or equivalent data shall show the magnitude of each harmonic and other spurious emission that can be detected when the equipment is operated under the conditions specified in Sec. 2.1049 as appropriate. The magnitude of spurious emissions which are attenuated more than 20 dB below the permissible value need not be specified.

FCC Sec. 2.1057

Frequency spectrum to be investigated.

(a) In all of the measurements set forth in Sec.s. 2.1051 and 2.1053, the spectrum shall be investigated from the lowest radio frequency signal generated in the equipment, without going below 9 kHz, up to at least the frequency shown below:

(1) If the equipment operates below 10 GHz: to the tenth harmonic of the highest fundamental frequency or to 40 GHz, whichever is lower.

(b) Particular attention should be paid to harmonics and subharmonics of the carrier frequency as well as to those frequencies removed from the carrier by multiples of the oscillator frequency. Radiation at the frequencies of multiplier stages should also be checked.

(c) The amplitude of spurious emissions which are attenuated more than 20 dB below the permissible value need not be reported.

FCC 87.139 (a)

The mean power of any emissions shall be attenuated below the mean output power of the transmitter (pY) as follows:

- (1) When the frequency is removed from the assigned frequency by more than 50 percent up to and including 100 percent of the authorized bandwidth the attenuation shall be at least 25 dB.
- (2) When the frequency is removed from the assigned frequency by more than 100 percent up to and including 250 percent of the authorized bandwidth the attenuation shall be at least 35 dB.
- (3) On any frequency removed from the assigned frequency by more than 250 percent of the authorized bandwidth the attenuation for aircraft station transmitters shall be at least 40 dB; and the attenuation of aeronautical station transmitters must be at least $43 + 10 * \log_{10}(pY)$ dB.

1.4.2 TEST PROCEDURE

At the frequency of maximum response, the audio input level required to produce 50% modulation was determined by temporarily substituting a modulation analyzer for the spectrum analyzer (see test set-up for modulation characteristics measurements). The modulating frequency was then set to 2500 Hz, and the input level was set 16 dB above that level determined above. In order to prevent the spectrum analyzer from producing erroneous readings, the carrier was attenuated by a highpass filter. The transmitted spectrum was then examined with resolution sufficient to verify that no spurious output exceeded the allowable level. The spectrum was examined to beyond the tenth harmonic.

1.4.3 TEST RESULTS

No spurious output exceeded the allowable level. The following data sheets show the results of the measurements.

Spurious Emissions Data Sheet

Type Number: VHF-2100		Serial Number: 18J9V
Date tested: 11/19/03		Tested by: J Chetwynd
Measurement at 118.000 MHz		Carried Power = 31.3 Watts
Maximum allowable power for any spurious emission: -60 dBc		
Spurious Emission Frequency	Relation to Carrier	DB Below Carrier
236.0 MHz	2 nd harmonic	86.5
354.0 MHz	3 rd harmonic	104.1
472.0 MHz	4 th harmonic	>105
590.0 MHz	5 th harmonic	>105
708.0 MHz	6 th harmonic	>105
826.0 MHz	7 th harmonic	>105
944.0 MHz	8 th harmonic	>105
1062.0 MHz	9 th harmonic	>105
1180.0 MHz	10 th harmonic	>105
No non-harmonic spurious emission was noted.		

Spurious Emissions Data Sheet

Type Number: VHF-2100		Serial Number: 18J9V
Date tested: 11/19/03		Tested by: J Chetwynd
Measurement at 127.000 MHz		Carried Power = 31.9 Watts
Maximum allowable power for any spurious emission: -60 dBc		
Spurious Emission Frequency	Relation to Carrier	dB below Carrier
254.0 MHz	2 nd harmonic	84.9
381.0 MHz	3 rd harmonic	104.4
508.0 MHz	4 th harmonic	>110
635.0 MHz	5 th harmonic	>110
762.0 MHz	6 th harmonic	>110
889.0 MHz	7 th harmonic	>110
1016.0 MHz	8 th harmonic	>110
1143.0 MHz	9 th harmonic	>110
1270.0 MHz	10 th harmonic	>110
No non-harmonic spurious emission was noted.		

Spurious Emissions Data Sheet

Type Number: VHF-2100		Serial Number: 18J9V
Date tested: 11/19/03		Tested by: J. CHETWYND
Measurement at 136.975 MHz		Carried Power = 29.9 Watts
Maximum allowable power for any spurious emission: -60 dBc		
Spurious Emission Frequency	Relation to Carrier	dB below Carrier
273.95 MHz	2 nd harmonic	76.2
410.925 MHz	3 rd harmonic	94.0
547.9 MHz	4 th harmonic	>117
684.875 MHz	5 th harmonic	>117
821.85 MHz	6 th harmonic	>117
958.825 MHz	7 th harmonic	>117
1095.8 MHz	8 th harmonic	>117
1232.775 MHz	9 th harmonic	>117
1369.75 MHz	10 th harmonic	>117
No non-harmonic spurious emission was noted.		

1.5 FIELD STRENGTH OF SPURIOUS RADIATION

1.5.1 REQUIREMENTS

FCC Sec. 2.1053

Measurements required: Field strength of spurious radiation.

(a) Measurements shall be made to detect spurious emissions that may be radiated directly from the cabinet, control circuits, power leads, or intermediate circuit elements under normal conditions of installation and operation. Curves or equivalent data shall be supplied showing the magnitude of each harmonic and other spurious emission. For equipment operating on frequencies below 890 MHz, an open field test is normally required, with the measuring instrument antenna located in the far-field at all test frequencies. Information submitted shall include the relative radiated power of each spurious emission with reference to the rated power output of the transmitter, assuming all emissions are radiated from half-wave dipole antennas.

(b) The measurements specified in paragraph (a) of this section shall be made for the following equipment:

- (1) Those in which the spurious emissions are required to be 60 dB or more below the mean power of the transmitter.
- (2) All equipment operating on frequencies higher than 25 MHz.

FCC Sec. 2.1057

Frequency spectrum to be investigated.

(a) In all of the measurements set forth in Sec.s. 2.1051 and 2.1053, the spectrum shall be investigated from the lowest radio frequency signal generated in the equipment, without going below 9 kHz, up to at least the frequency shown below:

(1) If the equipment operates below 10 GHz: to the tenth harmonic of the highest fundamental frequency or to 40 GHz, whichever is lower.

(b) Particular attention should be paid to harmonics and subharmonics of the carrier frequency as well as to those frequencies removed from the carrier by multiples of the oscillator frequency. Radiation at the frequencies of multiplier stages should also be checked.

(c) The amplitude of spurious emissions which are attenuated more than 20 dB below the permissible value need not be reported.

FCC 87.139 (a)

The mean power of any emissions shall be attenuated below the mean output power of the transmitter (pY) as follows:

- (1) When the frequency is removed from the assigned frequency by more than 50 percent up to and including 100 percent of the authorized bandwidth the attenuation shall be at least 25 dB.
- (2) When the frequency is removed from the assigned frequency by more than 100 percent up to and including 250 percent of the authorized bandwidth the attenuation shall be at least 35 dB.
- (3) On any frequency removed from the assigned frequency by more than 250 percent of the authorized bandwidth the attenuation for aircraft station transmitters shall be at least 40 dB; and the attenuation for aeronautical station transmitters must be at least $43 + 10 * \log_{10}(pY)$ dB.

1.5.2 TEST PROCEDURE

This test was performed on an open-field range meeting the requirements of ANSI Standard c63.4-1992. Testing was performed in Rubicom Systems, Inc., 284 West Drive, Melbourne FL. Rockwell Collins supplied the VHF-2100 unit to be tested, mounting tray, cables, interface unit and power supply. Rubicom supplied radiated measuring equipment (calibrated antennae and spectrum analyzer) and measurement platform.

1.5.3 TEST RESULTS

The test report indicates the requirements were met. The test report from Rubicom Systems, Inc. is in Exhibit K.

1.6 FREQUENCY STABILITY

1.6.1 REQUIREMENTS

FCC Sec. 2.1055 (a)

Measurements required: Frequency stability.

(a) The frequency stability shall be measured with variation of ambient temperature as follows:

(2) From -20 deg. to +50 deg. centigrade for equipment to be licensed for use in the Maritime Services under part 80 of this chapter, except for Class A, B, and S Emergency Position Indicating Radio Beacons (EPIRBS), and equipment to be licensed for use above 952 MHz at operational fixed stations in all services, stations in the Local Television Transmission Service and Point-to-Point Microwave Radio Service under part 21 of this chapter, and equipment licensed for use aboard aircraft in the Aviation Services under part 87 of this chapter.

FCC 2.1055 (b)

Frequency measurements shall be made at the extremes of the specified temperature range and at intervals of not more than 10 deg. centigrade through the range. A period of time sufficient to stabilize all of the components of the oscillator circuit at each temperature level shall be allowed prior to frequency measurement. The short term transient effects on the frequency of the transmitter due to keying (except for broadcast transmitters) and any heating element cycling normally occurring at each ambient temperature level also shall be shown. Only the portion or portions of the transmitter containing the frequency determining and stabilizing circuitry need be subjected to the temperature variation test.

FCC 2.1055 (d)

The frequency stability shall be measured with variation of primary supply voltage as follows:

- (1) Vary primary supply voltage from 85 to 115 percent of the nominal value for other than hand carried battery equipment.
- (2) The supply voltage shall be measured at the input to the cable normally provided with the equipment, or at the power supply terminals if cables are not normally provided. Effects on frequency of transmitter keying at the nominal supply voltage and at each extreme also shall be shown.

FCC 87.133 (a)

The carrier frequency of each station in the Aviation Services shall be maintained with the following percentage of the assigned frequency:

Band – 100 to 137 MHz

Aircraft stations – 30 ppm (+/- 4109 Hz at test frequency of 136.975 MHz)

1.6.2 TEST PROCEDURE

Frequency Stability with Temperature

The transceiver was tuned to 136.975 MHz. Due to the nature of the frequency synthesizer design, any frequency error will be the highest at this operating frequency. Chamber air temperature was adjusted to -20 degrees C, and maintained for at least thirty minutes to allow circuit element stabilization before data were taken. The transmitter was then keyed, and the steady state frequency was recorded. Frequency was measured with the counter function of an HP8901B modulation analyzer, with reference provided by an external Rubidium secondary frequency standard.

To observe the keying transient, the transmitter output signal was mixed with the output of a signal generator. The signal generator frequency was adjusted to produce a low audio-frequency beat note against the transmitter steady-state frequency. The beat frequency was observed on an oscilloscope, triggered when the transmitter was keyed.

This procedure was repeated at 10 degrees C intervals to +50 degrees c. Steady state frequency measurements were taken every 10 degrees C. Keying transient measurements were taken at the temperature extremes and at 25 degrees C.

Frequency Stability with Supply Voltage

This transceiver is intended for operation in 27.5 VDC electrical systems. Steady-state and transient frequency measurements were made at nominal supply voltage, and at 85% and 115% of nominal voltage. The transceiver was tuned to a frequency of 136.975 MHz. These measurements were made at nominal room temperature.

1.6.3 TEST RESULTS

The requirements were met. The data sheets show steady-state frequency at each temperature and line voltage. The oscilloscope photographs show the beat frequency as a function of time, after keying the transmitter, between the transmit frequency and a stable reference oscillator offset 1 KHz from 136.975000 MHz. No keying transients were observable.

Frequency Stability Data Sheet

Type Number: VHF-2100	Serial Number: 18J9V
Data Tested: 11/20/03	Tested by: J. CHETWYND

Frequency Stability with Temperature		
Temperature	Measured Frequency (MHz)	Frequency Error
-20 ° C	136.974790	210HZ
-10 ° C	136.974810	190HZ
-0 ° C	136.974820	180HZ
+10 ° C	136.974800	200HZ
+20 ° C	136.974790	210HZ
+30 ° C	136.974770	230HZ
+40 ° C	136.974770	230HZ
+50 ° C	136.974750	250HZ
Maximum Allowable Frequency Error = 4109 Hz		

Frequency Stability with Supply Voltage		
Supply Voltage	Measured Frequency	Frequency Error (Hz)
23.38 VDC (85%)	136.974740	260HZ
27.50 VDC	136.974750	250HZ
31.63 VDC (115%)	136.974750	250HZ
Maximum Allowable Frequency Error – 4109 Hz		

KEYING TRANSIENT SETUP

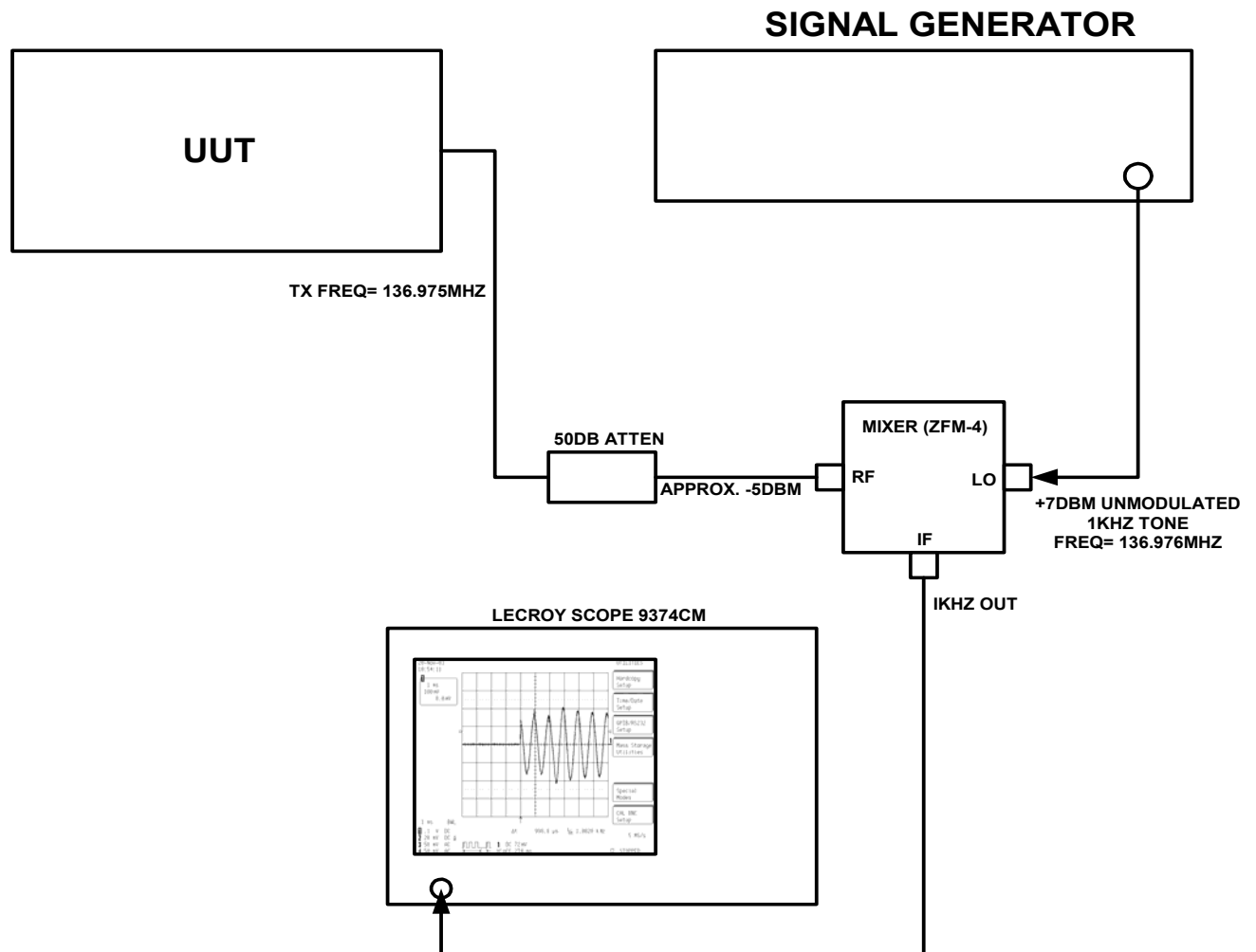

Keying Transients with Temperature

Keying Transients – Temperature –20 ° C

20-Nov-03
15:37:55

1
1 ms
100 mV
68.8 mV

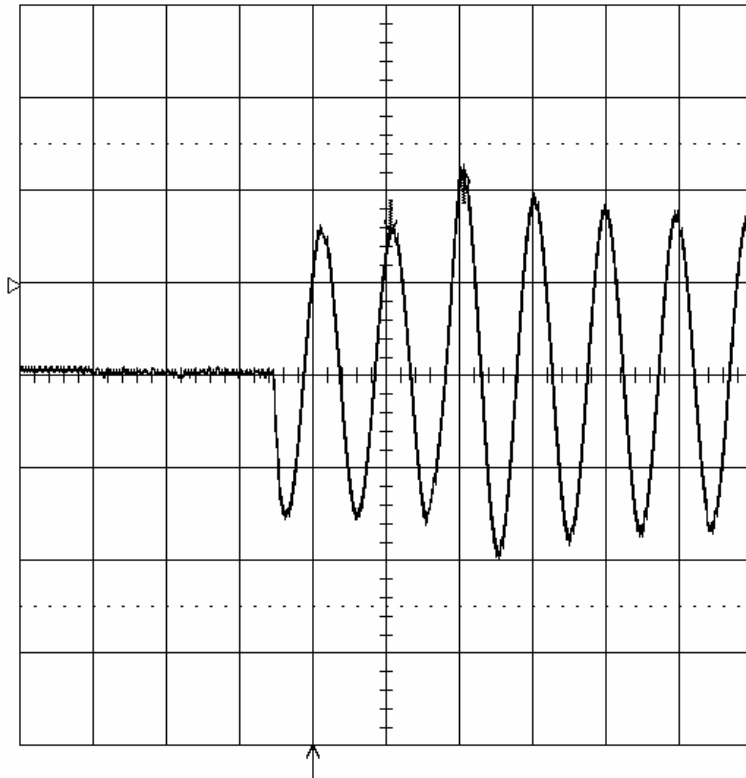

MEASURE

OFF **Cursors**
Parameters

mode
Time
Amplitude

type
Relative
Absolute

show
Diff - Ref
Diff & Ref

Reference
cursor
Track **OFF** On

Difference
cursor

1 ms BWL

- 1** .1 V DC
- 2** 20 mV DC $\times 10$
- 3** 50 mV AC
- 4** 50 mV AC

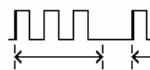

1 DC 98 mV
H'off 274 ms

Δt 993.4 μs $\frac{1}{\Delta t}$ 1.0066 kHz

5 MS/s

STOPPED

Keying Transients – Temperature 25 ° C

20-Nov-03
12:46:31

1
1 ms
100 mV
-6.3 mV

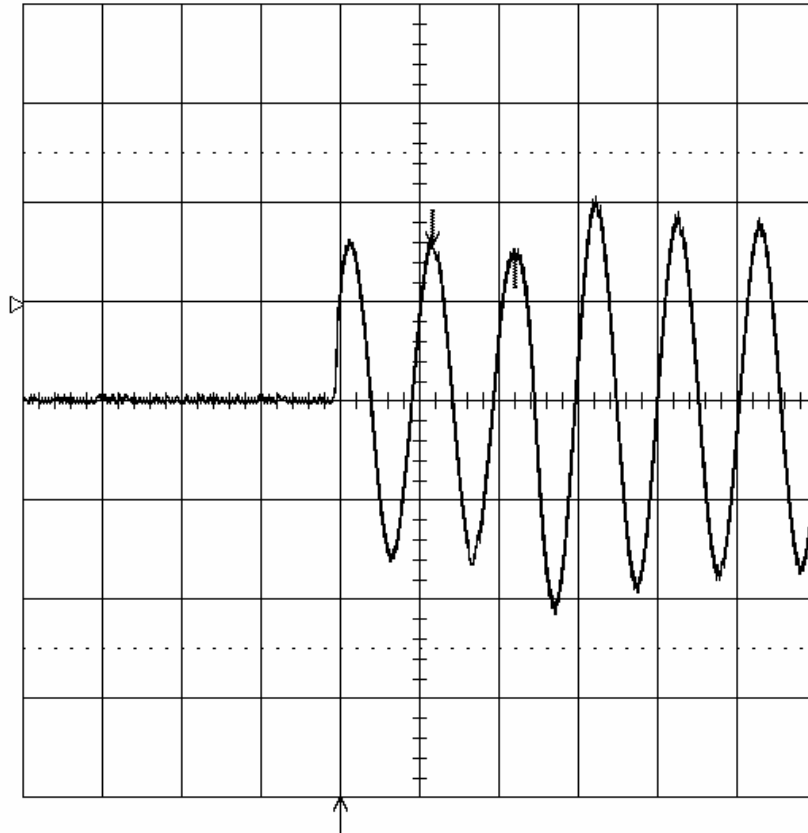

1 ms BWL

- 1 .1 V DC
- 2 20 mV DC
- 3 50 mV AC
- 4 50 mV AC

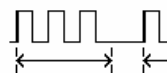

1 DC 98 mV
H'off 274 ms

Δt 1.0400 ms $\frac{1}{\Delta t}$ 961.53 Hz

5 MS/s

MEASURE

OFF **Cursors**
Parameters

mode
Time
Amplitude

type
Relative
Absolute

show
Diff - Ref
Diff & Ref

Reference
cursor
Track **OFF** On

Difference
cursor

STOPPED

Keying Transients – Temperature +50 ° C

20-Nov-03
10:54:11

1
1 ms
100 mV
0.0 mV

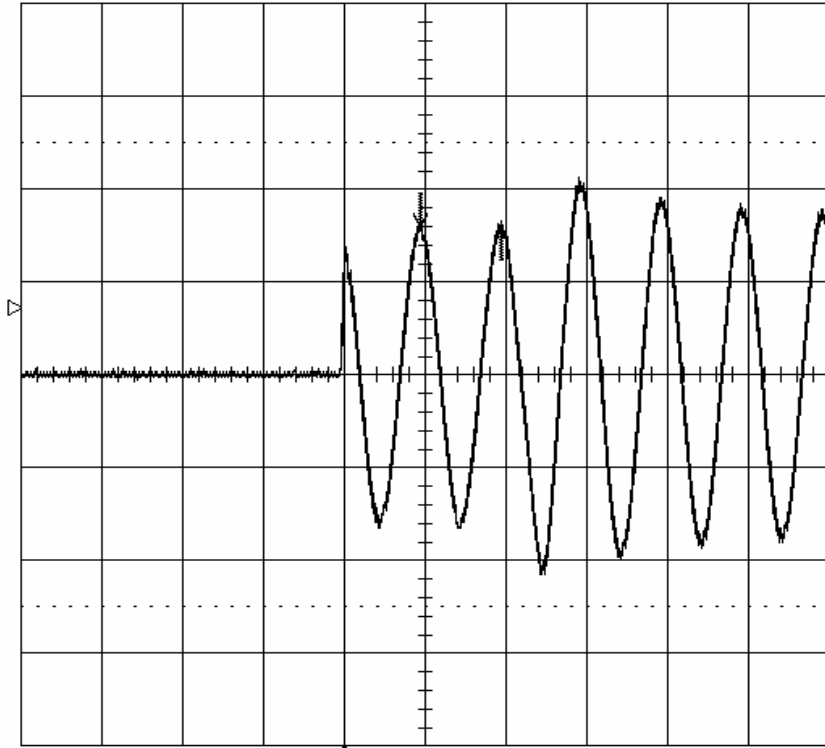

1 ms BWL
0 .1 V DC
2 20 mV DC $\times \frac{10}{10}$
3 50 mV AC
4 50 mV AC

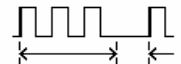

1 DC 72 mV
H' off 274 ms

Δt 998.0 μ s $\frac{1}{\Delta t}$ 1.0020 kHz

UTILITIES

- Handcopy Setup
- Time/Date Setup
- GPIB/RS232 Setup
- Mass Storage Utilities
- Special Modes
- CAL BNC Setup

5 MS/s

STOPPED

Keying Transients with Supply Voltage

Keying Transients – Voltage 23.38 VDC (85%)

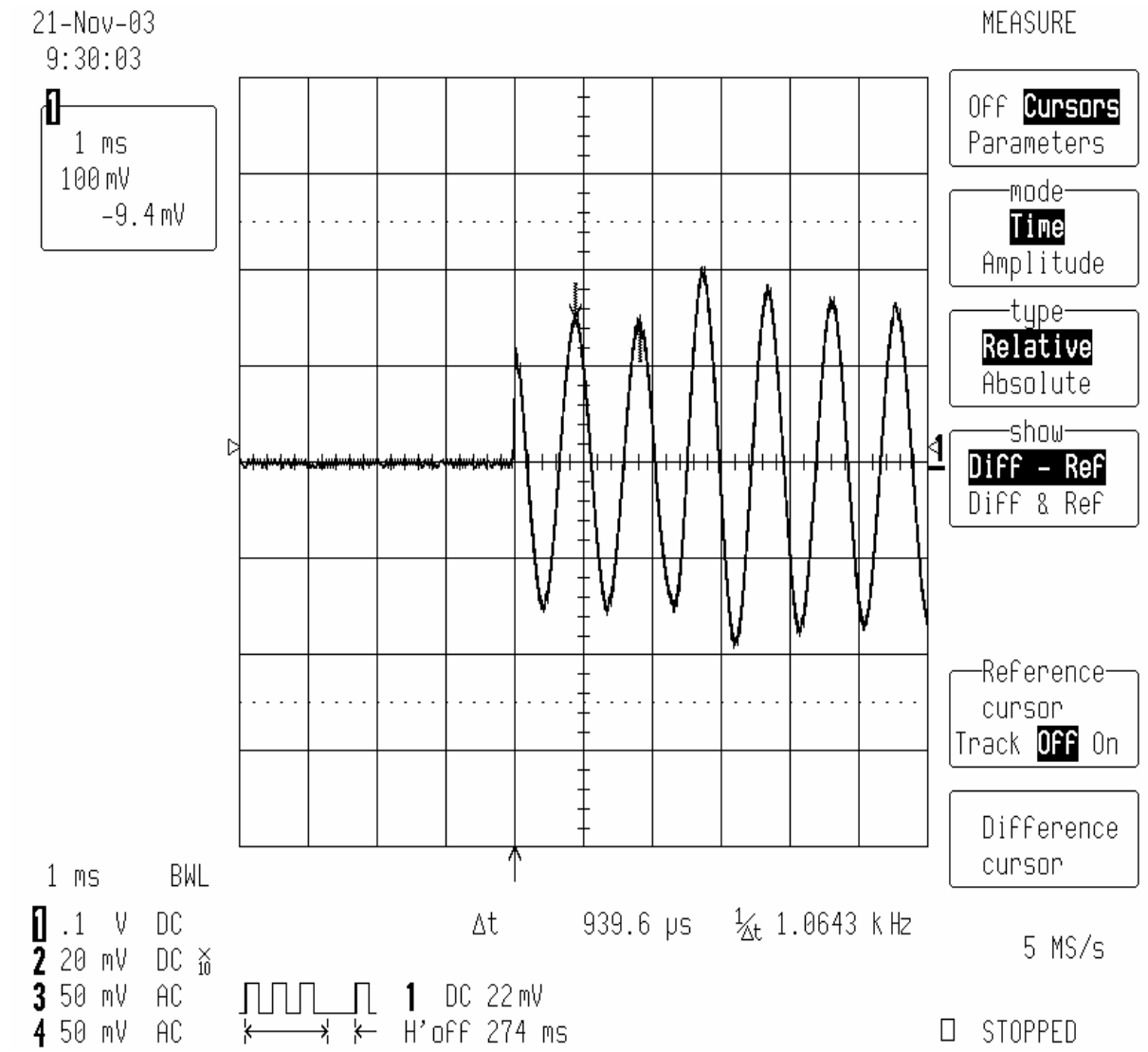

Keying Transients – Voltage 27.50 VDC

21-Nov-03
9:27:59

1
1 ms
100 mV
50.0 mV

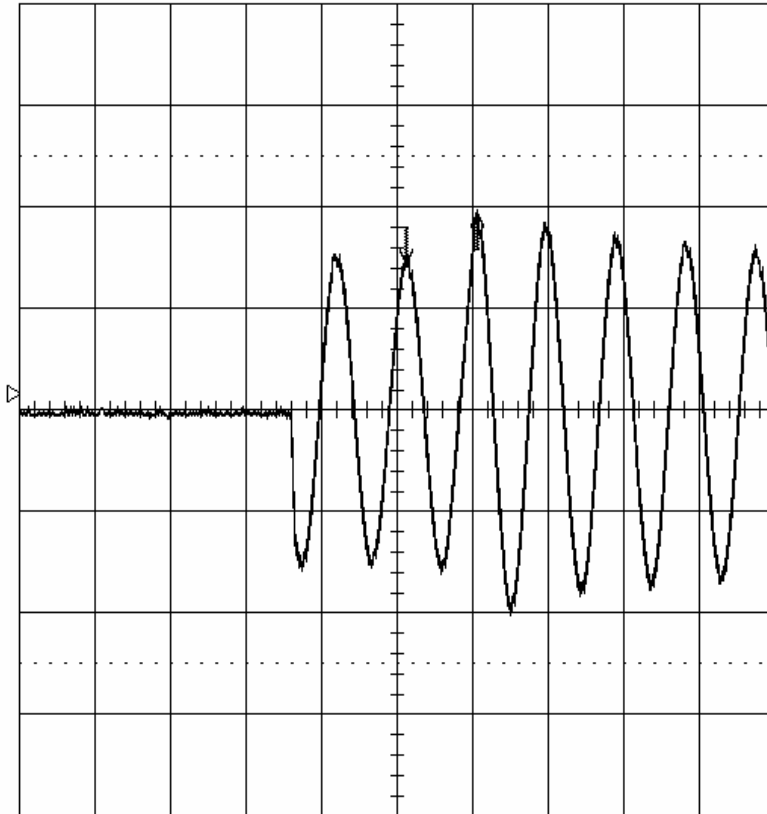

MEASURE

OFF **Cursors**
Parameters

mode
Time
Amplitude

type
Relative
Absolute

show
Diff - Ref
Diff & Ref

Reference
cursor
Track **OFF** On

Difference
cursor

1 ms BWL

- 1** .1 V DC
- 2** 20 mV DC \times_{10}
- 3** 50 mV AC
- 4** 50 mV AC

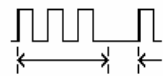

1 DC 22 mV
H' off 274 ms

Δt 948.6 μs $\frac{1}{\Delta t}$ 1.0542 kHz

5 MS/s

STOPPED

Keying Transients – Voltage 31.63 VDC (115%)

21-Nov-03
9:31:01

1
1 ms
100 mV
3.1 mV

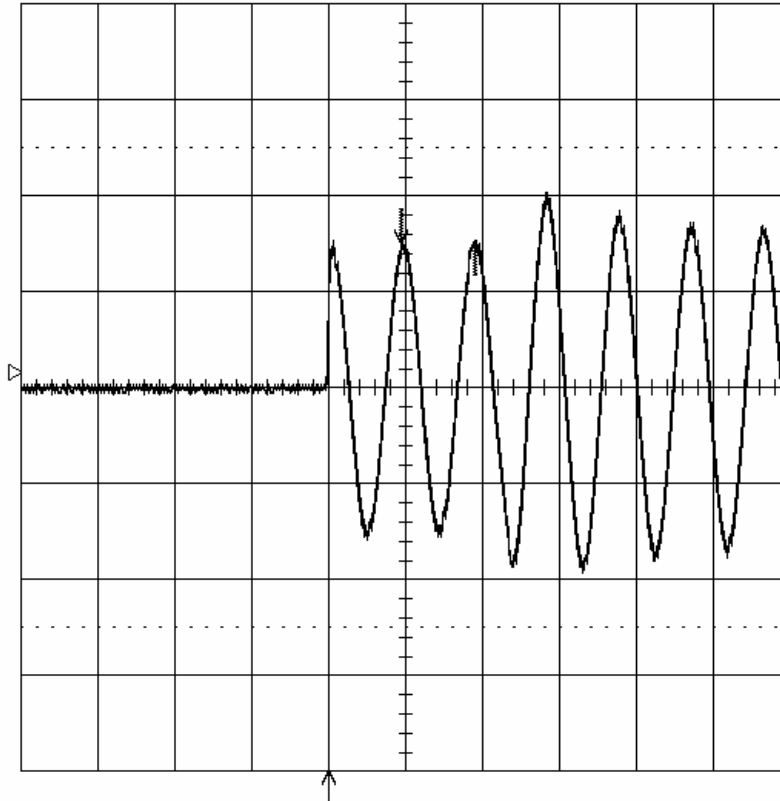

MEASURE

OFF **Cursors**
Parameters

mode
Time
Amplitude

type
Relative
Absolute

show
Diff - Ref
Diff & Ref

Reference
cursor
Track **OFF** On

Difference
cursor

1 ms BWL

- 1 .1 V DC
- 2 20 mV DC $\times 10$
- 3 50 mV AC
- 4 50 mV AC



1 DC 22 mV
H'off 274 ms

Δt 957.6 μs $\frac{1}{\Delta t}$ 1.0443 kHz

5 MS/s

STOPPED