

Figure 1

## 1. INTRODUCTION

This instruction sheet covers the assembly procedures for the AMP Circular Plastic Connectors (CPC) listed in Selection Charts 1 through 4. Typical connector configurations are shown in Figure 1.

Assembly procedures for CPC accessories—such as shield and strain relief, environmental sealing, keying plugs, and coupling rings—are covered on instruction sheet 408-7582.

Read this sheet carefully, and applicable referenced material, before assembling connectors, installing accessories, or panel mounting a connector.

Reasons for reissue are provided in Section 7, REVISION SUMMARY.

## 2. DESCRIPTION

There are four connector series. Series 1 connectors (Selection Chart 1) are available in four shell sizes

(11, 13, 17, and 23) and accept Type III+, and Subminiature COAXICON\* contacts. Series 2 connectors (Selection Chart 2) are available in three shell sizes (11, 17, and 23) and accept size 20 DM (screw machined) and 20 DF (precision formed) contacts. Series 3 connectors (Selection Chart 3) are available in two shell sizes (17 and 23) and accept Type XII power contacts. Series 4 connectors (Selection Chart 4) are available in one shell size (23) and accept a mixture of Type XII contacts from series 3 and size 16 contacts previously mentioned for Series 1 connectors.

The connector designator indicates the size and contact positions of the connector. For example, 11/4 – size 11, meaning the outside diameter in 16ths of an inch as measured across the coupling threads, and contact positions 4, meaning the number of contact cavities in the connector.

SERIES 1 CONNECTORS				RECOMMENDED CONTACTS
DES	SEX	HOUSING		
		DESCR	PART NO.	
11/4	Std	Plug	206060-1	Type III+ and Subminiature COAXICON Contacts (See Figure 2) (See 408-1379 and Catalog 82021)
		Rcpt (PM)	206061-1	
		Rcpt (FH)	206153-1	
	Rvs	Plug	206429-1	
		Rcpt (PM)	206430-1	
		Rcpt (FH)	206430-2	
13/9	Std	Plug	206708-1	
		Rcpt (PM)	206705-1	
		Rcpt (FH)	206705-2	
17/14	Rvs	Plug	206044-1	
		Rcpt (PM)	206043-1	
		Rcpt (FH)	206043-3	
17/16	Std	Plug	206037-1	
		Rcpt (PM)	206036-1	
		Rcpt (FH)	206036-3	
23/24		Plug	206837-1	
23/24		Rcpt (PM)	206838-1	
23/37		Plug	206150-1	
		Rcpt (PM)	206151-1	
		Rcpt (FH)	206151-2	
	Rvs	Plug	206305-1	
		Rcpt (PM)	206306-1	
		Rcpt (FH)	206306-2	

Selection Chart 1

SERIES 3 CONNECTORS				RECOMMENDED CONTACTS
DES	SEX	HOUSING		
		DESCR	PART NO.	
17/3	Std	Plug	206037-2	Type XII (See Figure 4) (See 408-1379 and Catalog 82021)
		Rcpt (PM)	206036-2	
		Rcpt (FH)	206207-1	
	Rvs	Plug	206426-1	
		Rcpt (PM)	206425-1	
		Rcpt (FH)	206425-2	
23/7	Std	Plug	206136-1	
		Rcpt (PM)	206137-1	
		Rcpt (FH)	206137-2	
	Rvs	Plug	206226-1	
		Rcpt (PM)	206227-1	
		Rcpt (FH)	206227-2	

Selection Chart 3

There are two connector styles, standard and reverse sex. Standard plugs have a **flush** mating face and standard receptacles have a **recessed** mating face. Reverse sex connectors are just the opposite — plugs have a **recessed** mating face and receptacles have a **flush** mating face. Note that socket contacts should be installed in a connector that has a **flush** mating face.

Receptacle connectors are available with mounting flanges for FRONT or REAR panel mount (PM) applications, and without mounting flanges for free hanging (FH) applications.

SERIES 2 CONNECTORS				RECOMMENDED CONTACTS
DES	SEX	HOUSING		
		DESCR	PART NO.	
11/8	Std	Plug	205838-1	Size 20 DF and 20 DM (See Figure 3) (See 408-1379 and Catalog 82021)
		Rcpt (PM)	205841-1	
		Rcpt (FH)	205841-2	
	Rvs	Plug	206434-1	
		Rcpt (PM)	206433-1	
		Rcpt (FH)	206433-2	
11/9	Std	Plug	206485-1	
		Rcpt (PM)	206486-1	
		Rcpt (FH)	206486-2	
17/28		Plug	205839-3	
		Rcpt (PM)	205840-3	
		Rcpt (FH)	206152-1	
	Rvs	Plug	206039-1	
		Rcpt (PM)	206038-1	
		Rcpt (FH)	206038-2	
23/57		Plug	206437-1	
		Rcpt (PM)	206438-1	
		Rcpt (FH)	206438-2	
23/63	Std	Plug	205842-1	
		Rcpt (PM)	205843-1	
		Rcpt (FH)	205843-2	

Selection Chart 2

SERIES 4 CONNECTORS				RECOMMENDED CONTACTS
DES	SEX	HOUSING		
		DESCR	PART NO.	
23/13M	Std	Plug	211824-1	Type XII and Size 16 Multimate● (See Figures 2 and 4) (See 408-1379 and Catalog 82021)
		Rcpt (PM)	211825-1	
		Rcpt (FH)	211825-2	
23/16M	Std	Plug	207485-1	
		Rcpt (PM)	207486-1	
		Rcpt (FH)	207486-2	
23/22M	Std	Plug	206612-1	
		Rcpt (PM)	206613-1	
		Rcpt (FH)	206613-3	

● III+ and Subminiature COAXICON Contacts

Selection Chart 4

Each receptacle has polarizing keys to assure proper mating. To provide circuit identification, contact cavities are numbered on the FRONT and BACK of each connector.

### 3. CONNECTOR SELECTION

Using the Selection Charts and Section 2, DESCRIPTION, determine the appropriate connectors to be used by the following method:

1. Determine application requirements (Series 1, 2, 3, or 4).
2. Determine number of contact positions required.
3. Determine which connector style (standard or reverse) is desired.
4. Select plug housing. Determine whether or not panel mount application is to be used and select applicable receptacle housing.

**4. CONTACTS**

**Selection** – When selecting contacts according to the Selection Charts on this sheet, refer to Catalog 82021. For visual identification of the proper contacts to be used in the various connector series, see Figures 2, 3, and 4.

For contacts used in Series 1 connectors, Multimate contacts, see Figure 2. Due to the large selection available for crimp type contacts and hand crimping tools, refer to instruction sheet 408-1379.

For contacts used in Series 2 connectors, size 20 DM and 20 DF contacts, see Figure 3.

For contacts used in Series 3 connectors, Type XII contacts, see Figure 4.

For contacts used in Series 4 connectors, Multimate and Type XII contacts, see Figures 2 and 4.

**Recommendation** – Socket contacts should be attached to wires leading to power source and installed in housing that has flush mating surface. This procedure provides maximum protection for both the pin and the socket contact, and minimizes the possibility of electrical shock.

**Crimping** – Strip form contacts are designed to be crimped with a semi-automatic or automatic machine. Consult your local Tyco Electronics representative for assistance in selecting the machine that will best suit your needs.

Loose piece contacts are designed to be crimped with crimp tooling (hand tools, die assemblies, or crimping heads). The applicable crimp tooling for the contacts is listed on 408-1379. Read the material packaged with the crimp tooling for the proper crimping procedure.

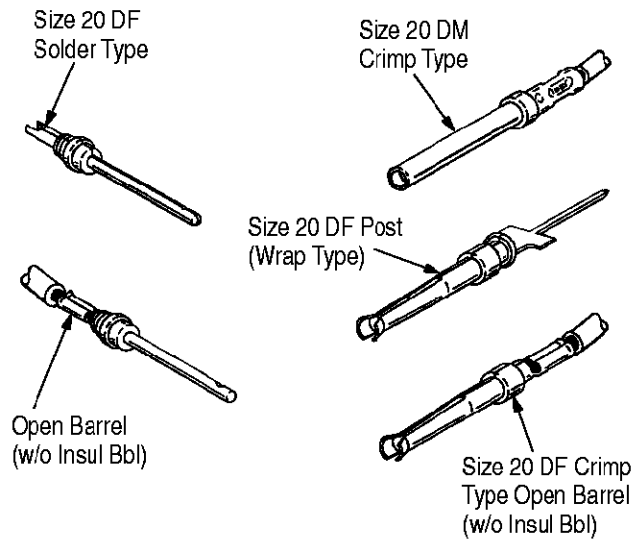

Figure 3

**Power Contacts**

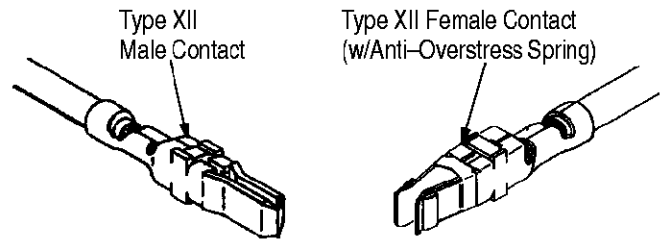
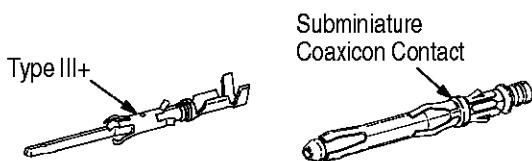
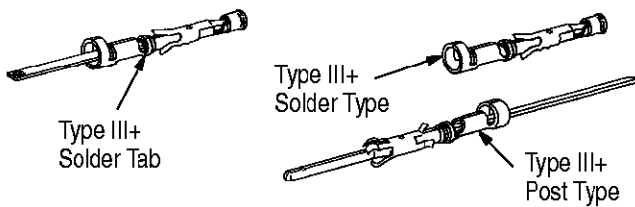

Figure 4

**Multimate Contacts**



**Crimp-Type Contacts (Typ)**

Figure 2

**Contact Insertion (Typical)**

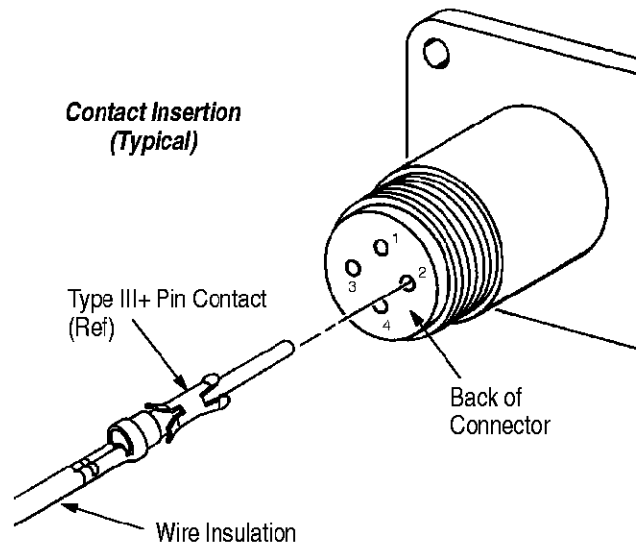

Figure 5

**Insertion** – Normally, an insertion tool is not required to insert contacts into the housings. However, if the wire bundle is large, or if the wire is fragile, an insertion tool is recommended. Refer to 408-1379 for the appropriate insertion tool.

To insert a contact, grip insulation of wire (directly behind contact) and align contact with BACK of desired contact cavity. Insert contact straight into cavity until it bottoms. Pull back lightly on wire to be sure contact is locked in place. (See Figure 5).

**Extraction** – Extraction tools, (refer to 408-1379), are designed for removing pin and socket contacts from the connectors. Refer to the instruction material packaged with the tool for the proper extraction procedure.

Release the contact from the FRONT of Series 1, 3 and 4 connectors, and from the BACK of Series 2 connectors. (See Figure 6).

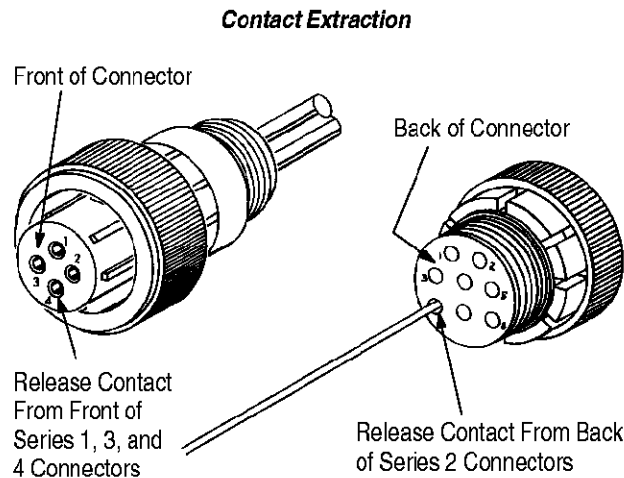
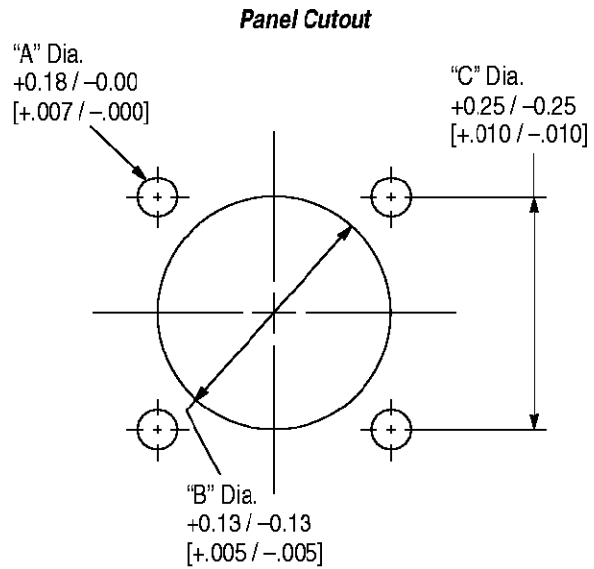

Figure 6

**5. PANEL MOUNTING**

The receptacle may be either FRONT or REAR panel mounted. When REAR mounted, the panel thickness must not exceed 3.18 mm [1/8 inch], otherwise plug will bottom on panel before it is secure.

Determine size of connector to be mounted. Refer to the applicable dimensions provided in Figure 7 and make the panel cutout. Secure connector to panel using commercially available hardware (No. 4 screws).



**NOTE:** Dimensions are in millimeters [with inches in brackets].

CONNECTOR SIZE	DIMENSIONS		
	A	B	C
11	3.18 [.125]	21.59 [.850]	21.44 [.844]
13	3.18 [.125]	24.49 [.964]	24.61 [.969]
17	3.81 [.150]	29.36 [1.156]	28.58 [1.125]
23	3.81 [.150]	40.89 [1.610]	36.53 [1.438]

Figure 7

**6. MATING CONNECTORS**

These connectors have a positive lock feature which prevents accidental disengagement. Align polarizing keys and keyways and start plug into receptacle. Rotate coupling ring CLOCKWISE until positive lock snaps into position.

**NOTE** Do not use for blind mating applications.

**7. REVISION SUMMARY**

Revisions to this document include:

Per EC 0990-0417-01:

- Updated document to corporate requirements
- Replaced Catalog CPC/CMC 73-204 with Catalog 82021