



500 SERIES INSTALLATION MANUAL

GPS 500 and GNS™ 530/530A

GNS is a trademark of Garmin Ltd. or its subsidiaries and may not be used without the express permission of Garmin.



(GNS™ 530 Shown)



Garmin International, Inc.

190-00181-02, Revision J
July 2004

Copyright 1998 - 2004
Garmin Ltd. or its subsidiaries
All Rights Reserved

Except as expressly provided herein, no part of this manual may be reproduced, copied, transmitted, disseminated, downloaded or stored in any storage medium, for any purpose without the express prior written consent of Garmin. Garmin hereby grants permission to download a single copy of this manual and of any revision to this manual onto a hard drive or other electronic storage medium to be viewed and to print one copy of this manual or of any revision hereto, provided that such electronic or printed copy of this manual or revision must contain the complete text of this copyright notice and provided further that any unauthorized commercial distribution of this manual or any revision hereto is strictly prohibited.

Garmin International, Inc.
1200 E. 151st Street
Olathe, KS 66062 USA
Telephone: 913-397-8200
Aviation Panel-Mount Technical Support Line (Toll Free): 1-888-606-5482
Web Site Address: www.garmin.com

Garmin (Europe) Ltd.
Unit 5, The Quadrangle
Abbey Park Industrial Estate
Romsey, SO51 9DL U.K.
Telephone: 44/1794.519944

RECORD OF REVISIONS

Revision	Revision Date	Description	ECO #
A	2/10/00	Initial Release	12684
B	3/6/00	Add new installation accessory kits.	12845
C	9/22/00	Add unit versions with 14/28 volt transmitter. Update configuration pages.	14159
D	4/12/01	Add GPS 500 data. Update configuration pages.	15595
E	5/22/02	Add gray unit and 16 watt "A" versions. Update configuration pages	18221
F	12/13/02	Add Fault Detection and Exclusion	19978
G	5/5/03	Correct 28 volt and 11-33 volt part numbers	21002
H	2/5/04	Update for TAWS/TERRAIN	24354
J	7/26/04	Update for TAWS STC, removed TAWS external annunciator references, added TSO Limitations	26738

This manual reflects the operation of Main Software version 5.00. Some differences in operation may be observed when comparing the information in this manual to earlier or later software versions.

INFORMATION SUBJECT TO EXPORT CONTROL LAWS

This document may contain information which is subject to the Export Administration Regulations ("EAR") issued by the United States Department of Commerce (15 CFR, Chapter VII, Subchapter C) and which may not be exported, released, or disclosed to foreign nationals inside or outside of the United States without first obtaining an export license. A violation of the EAR may be subject to a penalty of up to 10 years imprisonment and a fine of up to \$1,000,000 under Section 2410 of the Export Administration Act of 1979. Include this notice with any reproduced portion of this document.

WARNING

This product, its packaging, and its components contain chemicals known to the State of California to cause cancer, birth defects, or reproductive harm. This Notice is being provided in accordance with California's Proposition 65. If you have any questions or would like additional information, please refer to our web site at www.garmin.com/prop65.

NOTE

Throughout this document references made to GNS 530 shall equally apply to the GNS 530A except where specifically noted.

NOTE

TAWS installation information is valid only for TAWS equipped units after TAWS TSOA is received. See Section 3 for a list of TAWS part number.

TABLE OF CONTENTS

1. GENERAL DESCRIPTION	
1.1 INTRODUCTION	1-1
1.2 EQUIPMENT DESCRIPTION	1-1
1.3 TECHNICAL SPECIFICATIONS	1-1
1.4 TSO LIMITATIONS	1-7
1.5 LICENSE REQUIREMENTS	1-7
1.6 CERTIFICATION	1-7
1.7 FAULT DETECTION AND EXCLUSION (FDE)	1-7
1.8 LIMITED WARRANTY	1-8
2. INSTALLATION	
2.1 INTRODUCTION	2-1
2.2 ANTENNA CONSIDERATIONS	2-1
2.3 RACK CONSIDERATIONS	2-3
2.4 CABLING AND WIRING	2-3
2.5 COOLING AIR	2-3
2.6 MINIMUM INSTALLATION REQUIREMENTS	2-3
3. INSTALLATION PROCEDURE	
3.1 UNIT AND ACCESSORIES	3-1
3.2 DATA BASE OPTIONS	3-4
3.3 MISCELLANEOUS OPTIONS	3-4
3.4 INSTALLATION ACCESSORIES REQUIRED BUT NOT PROVIDED	3-4
3.5 ANTENNA INSTALLATION	3-4
3.6 CABLE INSTALLATION	3-5
3.7 RACK INSTALLATION	3-6
3.8 500 SERIES UNIT INSERTION AND REMOVAL	3-7
3.9 COM ANTENNA INSTALLATION CHECK (GNS 530)	3-7
4. SYSTEM INTERCONNECTS	
4.1 PIN FUNCTION LIST	4-1
4.2 POWER, LIGHTING, AND ANTENNAS	4-6
4.3 ALTIMETER	4-7
4.4 MAIN INDICATOR	4-8
4.5 ANNUNCIATORS/SWITCHES	4-10
4.6 SERIAL DATA	4-12
4.7 COM/VOR/ILS AUDIO (GNS 530 ONLY)	4-15
4.8 VOR/ILS INDICATOR (GNS 530 ONLY)	4-17
4.9 RMI/OBI	4-19
4.10 DME TUNING (GNS 530 ONLY)	4-20
4.11 TERRAIN AWARENESS WARNING SYSTEM (TAWS)	4-22
5. POST INSTALLATION CONFIGURATION & CHECKOUT PROCEDURE	
5.1 CONFIGURATION MODE OPERATIONS	5-1
5.2 INSTALLATION CONFIGURATION PAGES	5-1
5.3 ADDITIONAL GROUND TESTS	5-21
Appendix A. CERTIFICATION DOCUMENTS	
A.1 CONTINUED AIRWORTHINESS	A-1
A.2 ENVIRONMENTAL QUALIFICATION FORM—GNS 530	A-4
A.3 ENVIRONMENTAL QUALIFICATION FORM—GNS 530 w/TAWS	A-5
A.4 ENVIRONMENTAL QUALIFICATION FORM—GNS 530A	A-6
A.5 ENVIRONMENTAL QUALIFICATION FORM—GNS 530A w/TAWS	A-7
A.6 ENVIRONMENTAL QUALIFICATION FORM—GPS 500	A-8
A.7 ENVIRONMENTAL QUALIFICATION FORM—GPS 500 w/TAWS	A-9
A.8 ENVIRONMENTAL QUALIFICATION FORM—GA 56	A-10
Appendix B. STC PERMISSION	B-1
Appendix C. 500 SERIES RS-232 AVIATION DATA FORMAT	C-1
Appendix D. 500 SERIES RS-232 FUEL/AIR DATA INPUT FORMAT	D-1
Appendix E. 500 SERIES LRU INTERFACE OVERVIEW	E-1
Appendix F. DRAWINGS AND INTERCONNECTS	F-1

LIST OF FIGURES

FIGURE 2-1. GPS ANTENNA INSTALLATION CONSIDERATIONS	2-2
FIGURE 3-1. COAXIAL CABLE INSTALLATION	3-5
FIGURE 5-1. MAIN ARINC 429 CONFIG PAGE	5-1
FIGURE 5-2. MAIN RS-232 CONFIG PAGE	5-3
FIGURE 5-3. MAIN SYSTEM CONFIG PAGE.....	5-5
FIGURE 5-4. MAIN SYSTEM CONGIG PAGE.....	5-5
FIGURE 5-5. MAIN INPUTS PAGE	5-6
FIGURE 5-6. INSTRUMENT PANEL SELF TEST PAGE	5-6
FIGURE 5-7. MAIN LIGHTING PAGE	5-6
FIGURE 5-8. MAIN LIGHTING PAGE (DISPLAY LIGHTING FROM LIGHTING BUS)	5-8
FIGURE 5-9. DATE/TIME SETUP PAGE	5-8
FIGURE 5-10. MAIN DISCRETE I/O PAGE.....	5-9
FIGURE 5-11. MAIN CDI/OBS CONFIG PAGE.....	5-10
FIGURE 5-12. COM SETUP PAGE	5-12
FIGURE 5-13. VOR DISCRETE INPUTS PAGE	5-13
FIGURE 5-14. VOR/LOC/GS CDI PAGE	5-13
FIGURE 5-15. VOR/LOC/GS ARINC 429 CONFIG PAGE.....	5-14
FIGURE 5-16. STORMSCOPE CONFIG PAGE.....	5-15
FIGURE 5-17. STORMSCOPE TEST PAGE.....	5-15
FIGURE 5-18. STORMSCOPE DOWNLOAD DATA PAGE	5-16
FIGURE 5-19. TRAFFIC PAGE (SKYWATCH)	5-16
FIGURE 5-20. TRAFFIC PAGE (TCAD).....	5-16
FIGURE 5-21. RYAN TCAD CONFIG PAGE.....	5-17
FIGURE 5-22. GAD 42 CONFIG PAGE	5-17
FIGURE 5-23. DATA LINK PAGE.....	5-17
FIGURE 5-24. TAWS AUDIO CONFIG PAGE.....	5-17
FIGURE 5-25. TAWS AUDIO CONFIG PAGE 2.....	5-19
FIGURE F-1. GA 56 ANTENNA INSTALLATION DRAWING	F-3
FIGURE F-2. GNS 530 MOUNTING RACK DIMENSIONS	F-5
FIGURE F-3. GPS 500 MOUNTING RACK DIMENSIONS.....	F-7
FIGURE F-4. GNS 530 MOUNTING RACK INSTALLATION	F-9
FIGURE F-5. GPS 500 MOUNTING RACK INSTALLATION	F-11
FIGURE F-6. 500 SERIES RECOMMENDED PANEL CUTOUT DIMENSIONS	F-13
FIGURE F-7. 500 SERIES SYSTEM INTERFACE DIAGRAM	F-15
FIGURE F-8. GNS 530/(A) TYPICAL INSTALLATION.....	F-17
FIGURE F-9. GPS 500 TYPICAL INSTALLATION.....	F-19
FIGURE F-10. POWER, LIGHTING, AND ANTENNAS INTERCONNECT	F-21
FIGURE F-11. ALTIMETER INTERCONNECT.....	F-23
FIGURE F-12. MAIN INDICATOR INTERCONNECT	F-25
FIGURE F-13. KI 209A MAIN INDICATOR INTERCONNECT	F-27
FIGURE F-14. KI 208A MAIN INDICATOR INTERCONNECT	F-29
FIGURE F-15. ANNUNCIATORS/SWITCHES INTERCONNECT	F-31
FIGURE F-16. RS-232 SERIAL DATA INTERCONNECT	F-33
FIGURE F-17. ARINC 429 EFIS INTERCONNECT.....	F-35
FIGURE F-18. ARINC 429 SANDEL EHSI INTERCONN. (1 500 SERIES UNIT, 1 SANDEL SN3308).....	F-37
FIGURE F-19. ARINC 429 SANDEL EHSI INTERCONNECT (2 GNS 530, 1 SANDEL SN3308).....	F-39
FIGURE F-20. ARINC 429 SANDEL EHSI INTERCONNECT (2 GNS 530, 2 SANDEL SN3308).....	F-41
FIGURE F-21. ARINC 429/RS-232 AIR DATA/IRU/AHRS INTERCONNECT.....	F-43
FIGURE F-22. ARINC 429 FLIGHT CONTROL INTERCONNECT	F-45
FIGURE F-23. TRAFFIC ADVISORY SYSTEM INTERCONNECT	F-47
FIGURE F-24. GTX 330 INTERCONNECT	F-49
FIGURE F-25. WEATHER AND TERRAIN INTERCONNECT	F-51
FIGURE F-26. AUDIO PANEL INTERCONNECT	F-53
FIGURE F-27. VOR/ILS INDICATOR INTERCONNECT	F-55
FIGURE F-28. RMI/OBI INTERCONNECT.....	F-57
FIGURE F-29. KING SERIAL PANEL DME TUNING INTERCONNECT.....	F-59
FIGURE F-30. KING SERIAL REMOTE DME TUNING INTERCONNECT	F-61
FIGURE F-31. PARALLEL 2 OF 5 DME TUNING INTERCONNECT	F-63
FIGURE F-32. PARALLEL BCD/SLIP CODE DME TUNING INTERCONNECT	F-65

500 SERIES HARDWARE MOD LEVEL HISTORY

The following table identifies hardware modification (Mod) Levels for the GPS 500 and GNS 530. Mod Levels are listed with the associated service bulletin number, service bulletin date, and the purpose of the modification. The table is current at the time of publication of this manual (see date on front cover) and is subject to change without notice. Authorized Garmin Sales and Service Centers are encouraged to access the most up-to-date bulletin and advisory information on the Garmin Dealer Resource web site at www.garmin.com using their Garmin-provided user name and password.

MOD LEVEL	SERVICE BULLETIN NUMBER	SERVICE BULLETIN DATE	PURPOSE OF MODIFICATION
1	0019	11/7/00	Replace fuse in COM circuit with a resistor
2	0101	2/16/01	Remote COM transfer
3	0111	7/9/01	Improves VLOC Morse code ident
4	0203, Rev B	8/12/02	Improve receiver audio compressor performance
5	0207	4/2/02	Remove excess solder from COM board
6	0211	6/4/02	Reduce input transients from Audio Panel

Note: Throughout this document references made to GNS 530 shall equally apply to the GNS 530A except where specifically noted.

1. GENERAL DESCRIPTION

1.1 INTRODUCTION

This manual describes the physical, mechanical, and electrical characteristics and the installation requirements for the 500 Series (GPS 500 and GNS 530) panel-mounted units. After installation of the 500 Series system, FAA Form 337 must be completed by an appropriately certificated agency to return the aircraft to service.

Note: Throughout this document references made to GNS 530 shall equally apply to the GNS 530A except where specifically noted.

1.2 EQUIPMENT DESCRIPTION

The 500 Series units are mark width (6.25" wide) units, and 4.60" high. The display is a 320 by 234 pixel color LCD. The units include two removable data cards, one with a Jeppesen database (to be inserted in the left most card slot), and the second being a TAWS/TERRAIN database (to be inserted in the right most card slot).

The GPS 500 is a GPS receiver certifiable for IFR en route, terminal, and non-precision approach operations.

The GNS 530 includes all the features of the GPS 500, and also includes IFR certified airborne VHF communications transceiver and an IFR certified airborne VOR/Localizer and Glideslope receivers. The (A) model is a 28 Vdc unit with a 16 Watt COM transmitter. Both units are TAWS/TERRAIN upgradeable.

GPS signals are received by Garmin's low profile GA 56 antenna (P/N 010-10040-0X).

CAUTION

The 500 Series product lens is coated with a special anti-reflective coating which is very sensitive to skin oils, waxes and abrasive cleaners. CLEANERS CONTAINING AMMONIA WILL HARM THE ANTI-REFLECTIVE COATING. It is very important to clean the lens using an eyeglass lens cleaner, which is specified as safe for anti-reflective coatings and a clean, lint-free cloth.

CAUTION

The use of ground-based cellular telephones while aircraft are airborne is prohibited by FCC rules. Due to potential interference with onboard systems, the use of ground-based cell phones while the aircraft is on the ground is subject to FAA regulation 14 CFR §91.21.

FCC regulation 41 CFR §22.925 prohibits airborne operation of ground-based cellular telephones installed in or carried aboard aircraft. Ground-based cellular telephones must not be operated while aircraft are off the ground. When any aircraft leaves the ground, all ground-based cellular telephones on board that aircraft must be turned off.

Ground-based cell phones that are on, even in a monitoring state, can disrupt GPS performance.

1.3 TECHNICAL SPECIFICATIONS

The conditions and tests required for TSO approval of this article are minimum performance standards. It is the responsibility of those installing this article either on or within a specific type or class of aircraft to determine that the aircraft installation conditions are within the TSO standards. TSO articles must have separate approval for installation in an aircraft. The article may be installed only in compliance with 14 CFR part 43 or the applicable airworthiness requirements. For TSO compliance, see Appendix A.

1.3.1 Physical Characteristics

Bezel Height	4.58 in. (116 mm)
Bezel Width	6.25 in. (159 mm)
Rack Height (Dimple-to-dimple)	4.60 in. (117 mm)
Rack Width	6.32 in. (161 mm)
Depth Behind Panel with Connectors (Measured from face of aircraft panel to rear of connector backshells)	11.00 in. (279 mm)
GPS 500 Weight (Unit only)	5.7 lbs. (2.59 kg)
GPS 500 Weight (Installed with rack and connectors)	7.2 lbs. (3.27 kg)
GNS 530 Weight (Unit only)	7.0 lbs. (3.18 kg)
GNS 530 Weight (Installed with rack and connectors)	8.7 lbs. (3.95 kg)

1.3.2 General Specifications

Operating Temperature Range	-20°C to +55°C. For more details see Environmental Qualification Form.
Humidity	95% non-condensing
Altitude Range	-1,500 ft to 50,000 ft
Input Voltage Range GPS 500 (011-00562-00, -10) GNS 530 (011-00550-10, -30)	11 to 33 Vdc
Input Voltage Range GNS 530 (011-00550-00)	22 to 33 Vdc
Input Voltage Range GNS 530A (011-00835-00, -10)	28 Vdc
Power Requirements GPS 500	800 mA @ 27.5 Vdc (maximum) 1.6 A @ 13.8 Vdc (maximum)
Power Requirements—P5001 (GNS 530 Main Connector)	1.8 A @ 27.5 Vdc (maximum) 3.6 A @ 13.75 Vdc (maximum)
Power Requirements—P5002 (COM Connector) GNS 530 (011-00550-00) GNS 530A (011-00835-00, -10)	15 mA @ 27.5 Vdc (not transmitting); 3.0 A @ 27.5 Vdc (transmitting)
Power Requirements—P5002 (COM Connector) GNS 530 (011-00550-10)	15 mA @ 27.5 Vdc (not transmitting); 3.0 A @ 27.5 Vdc (transmitting) 15 mA @ 13.75 Vdc (not transmitting); 6.0 A @ 13.75 Vdc (transmitting)
Superflag Power Requirements	500 mA max. Per superflag output @ 27.5 Vdc. 1.0 A max. @ 27.5 Vdc on P5001 (Main Superflags). 1.0 A max. @ 27.5 Vdc on P5006 (VOR/LOC, G/S Superflags).
Software	RTCA DO-178B level C
Environmental Testing	RTCA DO-160C. For more details see Environmental Qualification Forms.

1.3.3 GPS Specifications

Regulatory Compliance	TSO C129a Class A(1), RTCA DO-208
Acquisition Time	<ul style="list-style-type: none"> a) Search-the-Sky (without almanac, without initial position or time): 5 minutes b) AutoLocate™ (with almanac, without initial position or time): 5 minutes c) Cold Start (position known to 300 nm, time known to 10 minutes, with valid almanac): 45 seconds d) Warm Start (position known to 10 nm, time known to 10 minutes, with valid almanac and ephemeris): 15 seconds
Max Velocity	1000 kts.
Dynamics	6 g

1.3.4 COM Transceiver Specifications (GNS 530 Only) **

Regulatory Compliance	TSO-C37d Class 4 & 6* (3 & 5 for "A" models), TSO-C38d Class C & E, JTSO-2C37e, JTSO-2C38e, RTCA DO-186a ICAO Annex 10 Volume III (Part II – Voice Communications Systems) Par. 2.3.3
Audio Output	100 mW minimum into a 500 Ω load.
Audio Response	Less than 6 dB of Variation between 350 and 2500 Hz.
Audio Distortion	The distortion in the receiver audio output shall not exceed 15% at all levels up to 100 mW.
AGC Characteristics	The audio output shall not vary by more than 6 dB when the level of the RF input signal, modulated 30% at 1000 Hz, is varied from 5 μ V to 450,000 μ V.
Sensitivity	(S+N)/N on all channels shall be greater than 6 dB when the RF level is 2 μ V (hard) modulated 30% at 1000 Hz at rated audio.
Squelch	<ul style="list-style-type: none"> 2 μV \pm6 dB for 25 kHz channels. 3 μV \pm6 dB for 8.33 kHz channels.
Selectivity	<ul style="list-style-type: none"> 6 dB BW is greater than \pm8 kHz for 25 kHz channeling. 60 dB BW is less than \pm25 kHz for 25 kHz channeling. 6 dB BW is greater than \pm2.778 kHz for 8.33 kHz channeling. 60 dB BW is less than \pm7.37 kHz for 8.33 kHz channeling.
Spurious Response	Greater than 85 dB.
Transmitter Power	At Least 10 Watts*, 16 watts for "A" models.
Transmitter Duty Cycle	Recommended 10% maximum.
Modulation Capability	The modulation shall not be less than 70% and not greater than 98% with a standard modulator signal applied to the transmitter.
Carrier Noise Level	Shall be at least 45 dB (S+N)/N.
Frequency Stability	0.0005%
Demodulated Audio Distortion	Less than 10% distortion when the transmitter is modulated at least 70%.
Sidetone	1.4 V _{RMS} into a 500 Ω load when the transmitter is modulated at least 70%.
Demodulated Audio Response	Shall be less than 6 dB when the audio input frequency is varied from 350 to 2500 Hz.

* C37d Class 4 & 6 may not provide suitable COM transmit range for some high-altitude aircraft.

** Specifications shown apply at nominal input voltages of 13.75 Vdc or 27.5 Vdc, as applicable, and with a nominal 50 ohm resistive load at the antenna connector.

1.3.5 VOR Specifications (GNS 530 Only)

Regulatory Compliance	TSO C40c, JTSO-2C40c, RTCA DO-196, EuroCAE ED-22B ICAO Annex 10 Volume I (Radio Navigation Aids) Par. 3.3.8
Receiver Audio Sensitivity	At -103.5 dBm (S+N)/N shall not be less than 6 dB.
Course Deviation Sensitivity	-103.5 dBm or less for 60% of standard deflection.
Flag	The VOR Course Deviation Flag <u>must</u> be flagged: a) in the absence of an RF signal. b) in the absence of the 9960 Hz modulation. c) in the absence of either one of the two 30 Hz modulations. d) When the level of a standard VOR deviation test signal produces less than a 50% of standard deflection.
AGC Characteristics	From -99 dBm to -13 dBm input of a Standard VOR Audio Test Signal, audio output levels shall not vary more than 3 dB.
Spurious Response	Greater than 80 dB.
VOR OBS Bearing Accuracy	The bearing information as presented to the pilot shall not have an error in excess of 2.7° as specified by RTCA DO-196 and EuroCAE ED-22B.
Audio Output	A minimum 100 mW into a 500 Ω load.
Audio Response	Less than 6 dB of variation between 350 and 2500 Hz. Except the 1020 Hz Ident Tone is at least 20 dB down in voice mode.
Audio Distortion	The distortion in the receiver audio output shall not exceed 10% at all levels up to 100 mW.

1.3.6 LOC Specifications (GNS 530 Only)

Regulatory Compliance	TSO C36e, JTSO-C36e, RTCA DO-195 Class A, EuroCAE ED-46B Annex 10 Volume I (Radio Navigation Aids) Par. 3.1.4
Receiver Audio Sensitivity	At -103.5 dBm (S+N)/N shall not be less than 6 dB.
Course Deviation Sensitivity	-103.5 dBm or less for 60% of standard deflection.
Flag	The LOC Course Deviation Flag <u>must</u> be flagged: a) in the absence of an RF signal. b) When either the 90 or 150 Hz modulating signals is removed and the other is maintained at its normal 20%. c) In the absence of both 90 and 150 Hz modulation. d) When the level of a standard localizer deviation test signal produces less than a 50% of standard deflection.
AGC Characteristics	From -86 dBm and -33 dBm input of a Standard VOR Audio Test Signal, audio output levels shall not vary more than 3 dB.
Selectivity	Nose Bandwidth: The input signal level required to produce the reference AGC voltage shall not vary more than 6 dB over the input signal frequency range of ± 9 kHz from the assigned channel frequency. Skirt Bandwidth: The input signal level required to produce reference AGC voltage shall be at least 70 dB greater than the level required to produce reference AGC voltage at the assigned channel frequency at ± 36 kHz from the assigned channel frequency.
Spurious Response	Greater than 80 dB.
Centering Accuracy	Typical 0 ± 3 mV (Max error 9.9 mV per RTCA DO-195).
Audio Output	A minimum 100 mW into a 500 Ω load.
Audio Response	Less than 6 dB of Variation between 350 and 2500 Hz. Except the 1020 Hz Ident Tone is at least 20 dB down in voice mode.
Audio Distortion	The distortion in the receiver audio output shall not exceed 10% at all levels up to 100 mW.

1.3.7 Glideslope Specifications (GNS 530 Only)

Regulatory Compliance	TSO C34e, JTSO-C34e, RTCA DO-192, EuroCAE ED-47B
Sensitivity	-87 dBm or less for 60% of standard deflection.
Centering Accuracy	$0 \pm .0091$ ddm or 0 ± 7.8 mV.
Selectivity	The course deviation shall be $0 \text{ ddm} \pm .0091 \text{ ddm}$ when using the Glideslope Centering Test Signal as the RF frequency is varied ± 17 kHz from the assigned channel. At frequencies displaced by ± 132 kHz or greater, the input signal shall be at least 60 dB down.
Standard deflection	a) With a standard deflection 'FLY DOWN' condition (90 Hz dominant), the output shall be $-78 \text{ mV} \pm 7.8 \text{ mV}$. b) With a standard deflection 'FLY UP' condition (150 Hz dominant), the output shall be $+78 \text{ mV} \pm 7.8 \text{ mV}$.
Flag	The unit Flags: a) When the level of a standard deviation test signal produces 50% or less of standard deflection of the deviation indicator. b) In the absence of 150 Hz modulation. c) In the absence of 90 Hz modulation. d) In the absence of both 90 Hz and 150 Hz modulation. e) In the absence of RF.

1.3.8 TAWS

Regulatory Compliance	TSO-C151b Class B
------------------------------	-------------------

1.4 TSO LIMITATIONS

A limitation exists pertaining to TSO-C36e (Localizer) and TSO-C34e (Glideslope). The main board lateral deviation (J4001 Pin 21 MAIN +LEFT and J4001 Pin 22 MAIN +RIGHT) and vertical deviation (J4001 Pin 27 MAIN +UP and J4001 Pin 28 MAIN +DOWN) outputs exceed the respective TSO MOPS requirement for current response time due to 120 milliseconds of internal transport delay. Except for this transport delay, the output characteristics meet the TSO MOPS requirement. Consequently, these outputs should be used only in applications where the transport delay has been evaluated and found to meet installation requirements.

1.5 LICENSE REQUIREMENTS

The Telecommunications Act of 1996, effective February 8, 1996, provides the FCC discretion to eliminate radio station license requirements for aircraft and ships. The GNS 530 installation must comply with current transmitter licensing requirements. To find out the specific details on whether a particular installation is exempt from licensing, please visit the FCC web site <http://wireless.fcc.gov/aviation>.

If an aircraft license is required, make application for a license on FCC form 404, Application for Aircraft Radio Station License. The FCC also has a fax-on-demand service to provide forms by fax. The GNS 530 owner accepts all responsibility for obtaining the proper licensing before using the transponder.

CAUTION

THE VHF TRANSMITTER IN THIS EQUIPMENT IS GUARANTEED TO MEET FEDERAL COMMUNICATIONS COMMISSION ACCEPTANCE OVER THE OPERATING TEMPERATURE RANGE. MODIFICATIONS NOT EXPRESSLY APPROVED BY GARMIN COULD INVALIDATE THE LICENSE AND MAKE IT UNLAWFUL TO OPERATE THE EQUIPMENT.

1.6 CERTIFICATION

The GPS receivers in the 500 Series units are certified for IFR enroute, terminal, and non-precision approaches. The 500 Series initial certification was accomplished via STC's by Garmin in a Piper PA32. See Appendix B for copies of the STC's.

The 500 Series units have been qualified to RTCA/DO-160 Section 22 lightning requirements. Special installation considerations are required, refer to the Environmental Qualification Forms in Appendix A.

1.7 FAULT DETECTION AND EXCLUSION (FDE)

NOTE

The 500 Series equipment as installed has been found to comply with the requirements for GPS primary means of navigation in oceanic and remote airspace, when used in conjunction with the 500 Series Trainer Program incorporating the FDE Prediction Program. This does not constitute an operational approval.

The Garmin 500 Series Main and GPS Software version 3.00 and higher incorporate Fault Detection and Exclusion (FDE) display interface and control, satisfying the requirements for GPS as a Primary Means of Navigation for Oceanic/Remote Operations per FAA Notice N8110.60.

Fault Detection and Exclusion consists of two parts. The fault detection function detects a satellite failure that can affect navigation. The exclusion function refers to the capability of excluding one or more failed satellites and preventing them from affecting navigation.

FDE is provided for Oceanic and Remote Operations, non-precision approaches, en route and terminal phases of flight. FDE for non-oceanic flight phases adhere to the same missed alert probability, false alert probability, and failed exclusion probability specified by N8110.60.

The FDE function is built into the GPS 500/GNS 530 and does not require pilot interaction. In contrast, the FDE Prediction Program does require pilot interaction and must be used prior to oceanic/remote area flights to predict FDE availability.

The 500 Series Trainer software includes an FDE Prediction Program to meet the requirements for GPS as a primary means of navigation for oceanic/remote operations per N8110.60. The oceanic flight phase occurs on the GPS 500/GNS 530 when more than 200 nautical miles from the nearest airport.

All operators using the GPS 500/GNS 530 as primary means of navigation in oceanic/remote areas under FAR parts 91, 121, 125 and 135 must utilize the FDE Prediction Program prior to conducting a flight in these areas.

1.8 LIMITED WARRANTY

This Garmin product is warranted to be free from defects in materials or workmanship for two years from the date of purchase. Within this period, Garmin will at its sole option, repair or replace any components that fail in normal use. Such repairs or replacement will be made at no charge to the customer for parts or labor, provided that the customer shall be responsible for any transportation cost. This warranty does not cover failures due to abuse, misuse, accident or unauthorized alteration or repairs.

THE WARRANTIES AND REMEDIES CONTAINED HEREIN ARE EXCLUSIVE AND IN LIEU OF ALL OTHER WARRANTIES EXPRESS OR IMPLIED OR STATUTORY, INCLUDING ANY LIABILITY ARISING UNDER ANY WARRANTY OF MERCHANTABILITY OR FITNESS FOR A PARTICULAR PURPOSE, STATUTORY OR OTHERWISE. THIS WARRANTY GIVES YOU SPECIFIC LEGAL RIGHTS, WHICH MAY VARY FROM STATE TO STATE.

IN NO EVENT SHALL GARMIN BE LIABLE FOR ANY INCIDENTAL, SPECIAL, INDIRECT OR CONSEQUENTIAL DAMAGES, WHETHER RESULTING FROM THE USE, MISUSE, OR INABILITY TO USE THIS PRODUCT OR FROM DEFECTS IN THE PRODUCT. Some states do not allow the exclusion of incidental or consequential damages, so the above limitations may not apply to you.

Garmin retains the exclusive right to repair or replace the unit or software or offer a full refund of the purchase price at its sole discretion. SUCH REMEDY SHALL BE YOUR SOLE AND EXCLUSIVE REMEDY FOR ANY BREACH OF WARRANTY.

To obtain warranty service, contact your local Garmin Authorized Service Center. For assistance in locating a Service Center near you, call Garmin Customer Service at one of the numbers shown below.

Products sold through online auctions are not eligible for rebates or other special offers from Garmin. Online auction confirmations are not accepted for warranty verification. To obtain warranty service, an original or copy of the sales receipt from the original retailer is required. Garmin will not replace missing components from any package purchased through an online auction.

Garmin International, Inc.
1200 East 151st Street
Olathe, Kansas 66062, U.S.A.
Phone: 913/397.8200
FAX: 913/397.0836

Garmin (Europe) Ltd.
Unit 4, The Quadrangle, Abbey Park Industrial Estate
Romsey, SO51 9DL, U.K.
Phone: 44/1794.519944
FAX: 44/1794.519222

2. INSTALLATION

2.1 INTRODUCTION

Careful planning and consideration of the suggestions in this section are required to achieve the desired performance and reliability from the 500 Series unit. Any deviations from the installation instructions prescribed in this document shall be accomplished in accordance with the requirements set forth in FAA AC 43.13-2A, and 14 CFR Part 43 Maintenance, Preventive Maintenance, Rebuilding, and Alteration.

2.2 ANTENNA CONSIDERATIONS

Antenna installations on pressurized cabin aircraft require FAA approved installation design and engineering substantiation data whenever such antenna installations incorporate alteration (penetration) of the cabin pressure vessel by connector holes and/or mounting arrangements. For needed engineering support pertaining to the design and approval of such pressurized aircraft antenna installations, it is recommended that the installer proceed according to any of the following listed alternatives:

1. Obtain approved antenna installation design data from the aircraft manufacturer.
2. Obtain an FAA approved STC, pertaining to, and valid for the antenna installation.
3. Contact the FAA Aircraft Certification Office in the appropriate Region and request identification of FAA Designated Engineering Representatives (DERs) who are authorized to prepare and approve the required antenna installation engineering data.
4. Obtain FAA Advisory Circular AC-183C and identify a DER from the roster of individuals in it.
5. Contact an aviation industry organization such as the Aircraft Electronics Association for assistance.

2.2.1 GPS ANTENNA LOCATION

The GA 56 Antenna must be mounted on top of the aircraft. For best performance, select a location with an unobstructed view of the sky above the aircraft when in level flight. Figure 2-1 illustrates a typical GPS antenna installation. The antenna should be located at least three feet from transmitting antennas such as VHF COM, HF transmitter, DME, Transponder and Radar.

For rotorcraft, locate the GA 56 Antenna as far as possible from the main rotor hub. This reduces the percentage of time the blade blocks the antenna. Also mount it as far below the blade surface as possible if installing the antenna under the blade. This reduces signal distortion caused by the blades.

2.2.2 COM ANTENNA LOCATION

The GNS 530 COM antenna should be well removed from all projections, engines and propellers. The ground plane surface directly below the antenna should be a flat plane over as large an area as possible (18 inches square, minimum). The antenna should be mounted a minimum of six feet from any DME or other COM antennas, four feet from any ADF sense antennas, and three feet from the 500 Series and its GPS antenna.

If simultaneous use of two COM transceivers is desired (Spit-COM or simulcomm), use of the TX interlock function is mandatory. In addition, the COM antennas should be spaced for maximum isolation. A configuration of one topside antenna and one bottom side antenna is recommended.

2.2.3 VOR/LOC ANTENNA LOCATION

The GNS 530 VOR/LOC antenna should be well removed from all projections, engines and propellers. It should have a clear line of sight if possible. The antenna must be mounted along the centerline of the aircraft, minimizing the lateral offset.

2.2.4 GLIDESLOPE ANTENNA LOCATION

The GNS 530 Glideslope antenna should be well removed from all projections, engines and propellers. It should have a clear line of sight if possible.

2.2.5 ELECTRICAL BONDING

No special precautions need to be taken to provide a bonding path between the GPS antenna and the aircraft structure. Follow the manufacturers' instructions for the COM, VOR/LOC and Glideslope antennas.

2.2.6 ANTENNA LIMITATIONS

Garmin's GA 56 Antennas are recommended for installations where the airspeed of the aircraft is subsonic. In such installations, GA 56—Mod 1 or later—must be used. See the COM, VOR/LOC, and Glideslope antenna specifications for their limitations.

2.2.7 VHF COM INTERFERENCE OF GPS

On some installations VHF COM transceivers, Emergency Locator Transmitter (ELT) antennas, and Direction Finder (DF) receiver antennas can re-radiate through the GPS antenna. The 500 Series COM does not interfere with its own GPS section. However, placement of the GA 56 GPS antenna relative to a COM transceiver and COM antenna (including the GNS 530 COM antenna), ELT antenna, and DF receiver antenna is critical.

Use the following guidelines, in addition to others in this document, when locating the 500 Series unit and its antennas.

- GPS Antenna—Locate as far as possible from all COM antennas and all COM transceivers (including the 500 Series COM), ELT antennas, and DF receiver antennas. The GPS antenna is less susceptible to harmonic interference if a 1.57542 GHz notch filter is installed on the COM transceiver antenna output.
- Locate the 500 Series unit as far as possible from all COM antennas.

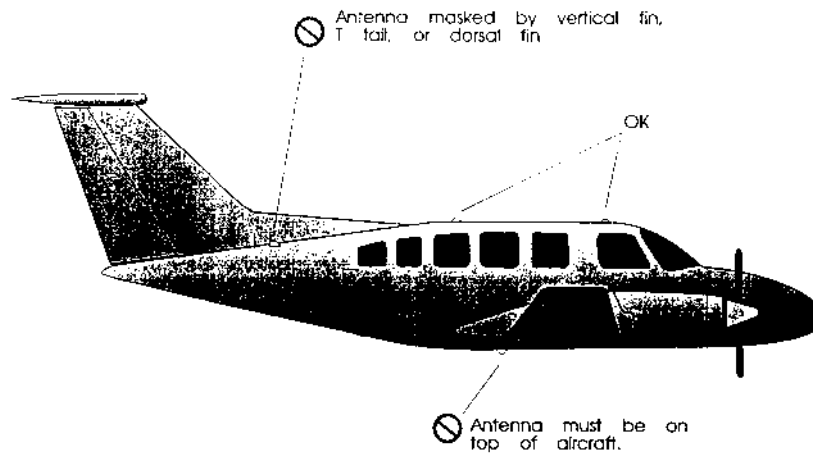

Figure 2-1. GPS Antenna Installation Considerations

If a COM antenna is found to be the problem, a 1.57542 GHz notch filter (Garmin P/N 330-00067-00) may be installed in the VHF COM coax, as close to the COM as possible. This filter is not required for the GNS 530 transmitter.

If a COM is found to be radiating, the following can be done:

1. Replace or clean VHF COM rack connector to ensure good coax ground.
2. Place a grounding brace between the 500 Series unit, VHF COM and ground.
3. Shield the VHF COM wiring harness.

2.2.8 COM, VOR/LOC, and Glideslope Antenna Installation Instructions

Install the COM, VOR/LOC, and Glideslope antennas according to the manufacturer's recommendations. Avoid running other wires and coaxial cables near the VOR/LOC antenna cable.

2.3 RACK CONSIDERATIONS

Plan a location which gives the pilot complete and comfortable access to the entire keypad and which is plainly visible from the pilot's perspective. Installation of remote switches and annunciators may not be required if the 500 Series unit is installed in the pilot's normal field of view (refer to the FAA letter in Appendix B).

Check that there is adequate depth for the rack in the instrument panel. A location away from heating vents or other sources of heat generation is optimal.

2.4 CABLING AND WIRING

Coaxial cable with 50 Ω nominal impedance and meeting applicable aviation regulations should be used for the installation. A typical maximum cable length for the GPS antenna is 40 feet. The installer should insure that the attenuation does not exceed 10 dB at 1.5 GHz for the specific installation.

Check that there is ample space for the cabling and mating connectors. Avoid sharp bends in cabling, particularly the COM antenna cable, and routing near aircraft control cables. Cabling for the 500 Series unit should not be routed near components or cabling which are sources of electrical noise. Do not route the COM antenna cable near any ADF antenna cables. Route the GPS, VOR/LOC, and Glideslope antenna cables as far as possible away from all COM transceivers and antenna cables.

2.5 COOLING AIR

The 500 Series units meet all TSO requirements without external cooling. However, as with all electronic equipment, lower operating temperatures extend equipment life. On the average, reducing the operating temperature by 15-20 °C (25 to 35 °F) doubles the mean time between failure (MTBF). Recommended airflow rating is 1 CFM (cubic foot per minute) at a pressure equivalent to 0.1 inches of water.

Potential damage to your 500 Series unit may occur by using outside forced air to cool the equipment. Therefore, it is recommended that an electric forced air fan be installed, of the indicated rating, to cool this equipment.

Units tightly packed in the avionics stack heat each other through radiation, convection, and sometimes by direct conduction. Even a single unit operates at a much higher temperature in still air than in moving air. Fans or some other means of moving the air around electronic equipment are usually a worthwhile investment. A 5/8" diameter air fitting is provided on the rear of the mounting rack for the purpose of admitting cooling air under such conditions. If a form of forced air cooling is installed, make certain that rainwater cannot enter and be sprayed on the equipment.

2.6 MINIMUM INSTALLATION REQUIREMENTS

Below is a list of required devices for TSO C129a category A1 and A2 certification. For a specific list of equipment used in the initial STC, obtain a copy of "GNS 530 in Piper PA32 Documented Installation" (P/N 190-00181-06). Deviations from that set of equipment should be approved by the FAA or the governing organization.

Pressure Altitude Device

This device delivers pressure altitude data to the 500 Series unit. This data can come from a parallel encoding altimeter, blind encoder, serializer, or an air data system.

Manual Course Device (Required for GNS 530 Only)

This device delivers the manual course select to the 500 Series unit, which is required for the GNS 530 VOR receiver, and optional for the 500/530 GPS receiver. Course information can come from an analog resolver, or from an EFIS/EHSI via ARINC 429 serial data.

HSI/CDI Indicator or EFIS

This device displays Nav Flag, Left/Right, To/From, Glideslope Flag, and Up/Down. The indicator(s) used in conjunction with the GNS 530 VOR/ILS receivers shall be TSO'd.

Qualified GPS Antenna

This antenna must be one of those listed in the accessories list, or meet the following requirements:

1. DO-160C Environmental Conditions

The antenna shall meet the environmental conditions listed below and shall conform to the test requirements of RTCA DO-160C.

<u>Environmental Condition</u>	<u>Category</u>	<u>Description</u>
Temperature (operating)	F2	-55 to +70°C
(ground survival)	F2	-55 to +85°C
Altitude	F2	55,000 feet
Temperature Variation	A	10°C per minute
Humidity	C	95% at +55°C
Vibration	CLMY	Turbo/Reciprocating/Helicopter
Waterproofness	S	Continuous Stream
Fluids	F	Deicing Fluid
Lightning	2A	Direct Effects
Icing	C	0.15" thick

2. Electrical Characteristics

LNA Supply voltage	4.5 ±0.5 Vdc
LNA Supply Current	20 mA Maximum
LNA Operating Frequency	1575.42 ± 2.00 MHz
LNA Gain	20 dB Maximum, 12dB Minimum
LNA Noise Figure	3.0 dB Maximum
LNA Output VSWR (50 Ω)	2:1 Maximum
LNA Input power at -1 dB Gain Compression	-6 dB Minimum
LNA Bandwidth	
(-3 dB)	40 MHz Maximum
(-20 dB)	100 MHz Maximum
(-40 dB)	250 MHz Maximum

3. Radiation Characteristics

Polarization	RHCP
Operating Frequency	1575.42 ± 2.00 MHz
Gain (on axis)	2.0 dBic Minimum
(at 160° beam width)	-6.0 dBic Minimum
Cross Pole Gain (LHCP)	
(on axis)	-8 dBic Maximum
(at 160° beam width)	-9 dBic Maximum

4. Mounting Requirements

Cable connection	BNC Female
Mounting studs	Four 8-32 UNC-2A studs 0.50" long

3. INSTALLATION PROCEDURE

3.1 UNIT AND ACCESSORIES

The GNS 530 units are available under the following part numbers:

3.1.1 GNS 530

CATALOG P/N	UNIT P/N	GNS 530A	TAWS	ACCESSORIES (1)	COLOR	OPERATING VOLTAGE	MINIMUM XMIT PWR
010-00182-00	011-00550-00	N	N	N	BLACK	28	10 W
010-00182-01	011-00550-00	N	N	Y	BLACK	28	10 W
010-00182-10	011-00550-10	N	N	N	BLACK	14 or 28 V	10 W
010-00182-11	011-00550-10	N	N	Y	BLACK	14 or 28 V	10 W
010-00182-30	011-00550-30	N	N	N	GRAY	14 or 28 V (2)	10 W
010-00182-31	011-00550-30	N	N	Y	GRAY	14 or 28 V (2)	10 W
010-00285-00	011-00835-00	Y	N	N	BLACK	28 Vdc	16 W
010-00285-01	011-00835-00	Y	N	Y	BLACK	28 Vdc	16 W
010-00285-10	011-00835-10	Y	N	N	GRAY	28 Vdc (2)	16 W
010-00285-11	011-00835-10	Y	N	Y	GRAY	28 Vdc (2)	16 W
010-00292-00	011-00864-00	Y	Y	N	BLACK	28 Vdc	16 W
010-00292-01	011-00864-00	Y	Y	Y	BLACK	28 Vdc	16 W
010-00292-10	011-00864-10	Y	Y	N	GRAY	28 Vdc (2)	16 W
010-00292-11	011-00864-10	Y	Y	Y	GRAY	28 Vdc (2)	16 W
010-00325-00	011-00940-00	N	Y	N	BLACK	14 or 28 V	10 W
010-00325-01	011-00940-00	N	Y	Y	BLACK	14 or 28 V	10 W
010-00325-10	011-00940-10	N	Y	N	GRAY	14 or 28 V (2)	10 W
010-00325-11	011-00940-10	N	Y	Y	GRAY	14 or 28 V (2)	10 W

3.1.2 GNS 530 TAWS Upgraded

Originally non-TAWS units that have been upgraded to include TAWS.

CATALOG P/N	UNIT P/N	GNS 530A	ACCESSORIES (1)	COLOR	OPERATING VOLTAGE	MINIMUM XMIT PWR
010-00292-20	011-00864-01	Y	N	BLACK	28 Vdc	16 W
010-00292-21	011-00864-01	Y	Y	BLACK	28 Vdc	16 W
010-00292-30	011-00864-11	Y	N	GRAY	28 Vdc (2)	16 W
010-00292-31	011-00864-11	Y	Y	GRAY	28 Vdc (2)	16 W
010-00325-40	011-00940-01	N	N	BLACK	14 or 28 V	10 W
010-00325-41	011-00940-01	N	Y	BLACK	14 or 28 V	10 W
010-00325-50	011-00940-11	N	N	GRAY	14 or 28 V (2)	10 W
010-00325-51	011-00940-11	N	Y	GRAY	14 or 28 V (2)	10 W
010-00325-60	011-00940-31	N	N	BLACK	28 Vdc	10 W
010-00325-61	011-00940-31	N	Y	BLACK	28 Vdc	10 W

1) The following accessories are included with the GNS 530 for those indicated with a “Y” above:

MOUNTING RACK (115-00345-00)
CONNECTOR KIT (011-00351-00)
BACK PLATE ASSEMBLY (011-00671-00)
GNS 530 PRODUCT INFO KIT (K00-00060-00)

2) Denotes alternate (secondary) power input available, (review installation drawing).

NOTE

The connector kit 011-00351-0x includes a single 78-pin high-density D connector for P5001. The second 78-pin connector on the back of the 500 Series unit (P5050) is used for installation of the TAWS Anunciator (013-00079-XX). There is a separate connector kit (011-00558-00) for installation of the TAWS Anunciator.

The GPS 500 units are available under the following part numbers:

3.1.3 GPS 500

CATALOG P/N	UNIT P/N	TAWS	ACCESSORIES (1)	COLOR	ALT PWR AVAILABLE
010-00176-00	011-00562-00	N	N	BLACK	N
010-00176-01	011-00562-00	N	Y	BLACK	N
010-00176-10	011-00562-10	N	N	GRAY	Y
010-00176-11	011-00562-10	N	Y	GRAY	Y
010-00291-00	011-00863-00	Y	N	BLACK	N
010-00291-01	011-00863-00	Y	Y	BLACK	N
010-00291-10	011-00863-10	Y	N	GRAY	Y
010-00291-11	011-00863-10	Y	Y	GRAY	Y

3.1.4 GPS 500 TAWS Upgraded

Originally non-TAWS units that have been upgraded to include TAWS.

CATALOG P/N	UNIT P/N	ACCESSORIES (1)	COLOR	ALT PWR AVAILABLE
010-00291-20	011-00863-01	N	BLACK	N
010-00291-21	011-00863-01	Y	BLACK	N
010-00291-30	011-00863-11	N	GRAY	Y
010-00291-31	011-00863-11	Y	GRAY	Y

1) The following accessories are included with the GPS 500 for those indicated with a “Y” above:

- MOUNTING RACK (115-00345-00)
- CONNECTOR KIT (011-00351-03)
- BACK PLATE ASSEMBLY (011-00671-01)
- GPS 500 PRODUCT INFO KIT (K00-00060-01)

3.1.5 Optional Accessories

The following installation accessories are available:

1. GPS Antenna Options:

- GA 56 Antenna Kit, without cable (Mod 1 or later, Garmin P/N 010-10040-01).
- This kit contains the following items:

ITEM	GARMIN P/N	QTY
GA 56 ANTENNA SUB-ASSEMBLY	011-00134-00	1
BACKING PLATE	115-00031-00	1
NUT, SELF-LOCKING, #8-32	210-10004-09	4
ANTENNA GASKET	253-00002-00	1

- GA 56 Flange Mount Antenna Kit (Mod 1 or later, Garmin P/N 010-10040-02).
- This kit contains the following items:

ITEM	GARMIN P/N	QTY
FLANGE MOUNT GA 56 ANTENNA SUB-ASSEMBLY	011-00147-00	1
NUT PLATE	115-00080-00	1
SCREW, #10-32 x 5/8"	211-62212-14	4
ANTENNA GASKET	253-00011-00	1

2. Other accessories include the following:

ITEM	GARMIN P/N
MOUNTING RACK, 500/530	115-00345-00
P5050 CONNECTOR KIT	011-00558-00
GPS 500 PILOT'S GUIDE	190-00181-60
GPS 500 QUICK REFERENCE GUIDE	190-00181-61
GPS 500 SAMPLE AIRPLANE FLIGHT MANUAL SUPPLEMENT	190-00181-64
GNS 530 PILOT'S GUIDE	190-00181-00
GNS 530 QUICK REFERENCE GUIDE	190-00181-01
GNS 530 SAMPLE AIRPLANE FLIGHT MANUAL SUPPLEMENT	190-00181-04
400/500 Series Garmin Display Interfaces – Pilot's Guide Addendum	190-00140-13

NOTE

A mounting rack is required for approved installations. The following hardware is required for installation of the mounting rack, but is not provided--#6-32 Flat Head Screw (6 ea.), #6-32 Self-locking Nut (6 ea.).

3.2 DATA BASE OPTIONS

ITEM	GARMIN P/N
DATA CARD, WORLD WIDE	010-10201-00
DATA CARD, AMERICAS	010-10201-01
DATA CARD, INTERNATIONAL	010-10201-02
DATA CARD, TAWS/TERRAIN*	010-10201-20

*Required for TAWS/TERRAIN.

3.3 MISCELLANEOUS OPTIONS

ITEM	GARMIN P/N
CONNECTOR, BNC, MALE, CLAMP	330-00087-00
LOW-LOSS AVIATION ANTENNA EXTENSION CABLE WITH RIGHT ANGLE BNC CONNECTOR, 15 FT.	320-00003-00
LOW-LOSS AVIATION ANTENNA EXTENSION CABLE WITH RIGHT ANGLE BNC CONNECTOR, 30 FT.	320-00003-02
GPS 1.57542 GHz NOTCH FILTER	330-00067-00

3.4 INSTALLATION ACCESSORIES REQUIRED BUT NOT PROVIDED

The following installation accessories are required but not provided:

- COM Antenna: (GNS 530 Only) Shall meet TSO C37() and C38(). Broad band, 50 Ω , vertically polarized with coaxial cable
- VOR/LOC Antenna: (GNS 530 Only) Shall meet TSO C40() and C36(). Broad band, 50 Ω , horizontally polarized with coaxial cable
- Glideslope Antenna: (GNS 530 Only) Shall meet TSO C34(). Broad band, 50 Ω , horizontally polarized with coaxial cable or low-loss splitter used with the VOR/LOC antenna
- Headphones: (GNS 530 Only) 500 Ω nominal impedance
- Microphone: (GNS 530 Only) Low impedance, carbon or dynamic, with transistorized pre-amp

3.5 ANTENNA INSTALLATION

For the COM, VOR/LOC, and Glideslope antennas, follow the manufacturers' instructions.

The remainder of this section applies to the GPS antenna. The GA 56 antenna outline and footprint dimensions are shown in Figure F-1, page F-3.

1. Using the backing plate as a template, mark the location of the mounting holes and the through hole for coaxial cable. Drill or punch the holes.
2. The antenna installation must provide adequate support for the antenna considering a maximum drag load of 5 lbs. For the GA 56 antennas (at subsonic speed). Install a doubler plate to reinforce thin-skinned aircraft. Observe guidelines for acceptable installation practices as outlined in AC 43.13-2A.
3. Seal the antenna and gasket to the fuselage using a good quality electrical grade sealant. Use caution to insure that the antenna connector is not contaminated with sealant. Insure that the mounting screws are fully tightened and that the antenna base is well seated against the gasket.

CAUTION

Do not use construction grade RTV sealant or sealants containing acetic acid. These sealants may damage the electrical connections to the antenna. Use of these type sealants may void the antenna warranty.

3.6 CABLE INSTALLATION

1. Route the coaxial cable to the rack location keeping in mind the recommendations of Section 2. Secure the cable in accordance with good aviation practice.
2. Trim the coaxial cable to the desired length and install the BNC connector (330-00087-00) per the cabling instructions on Figure 3-1. If the connector is provided by the installer, follow the connector manufacturer's instructions for cable preparation.

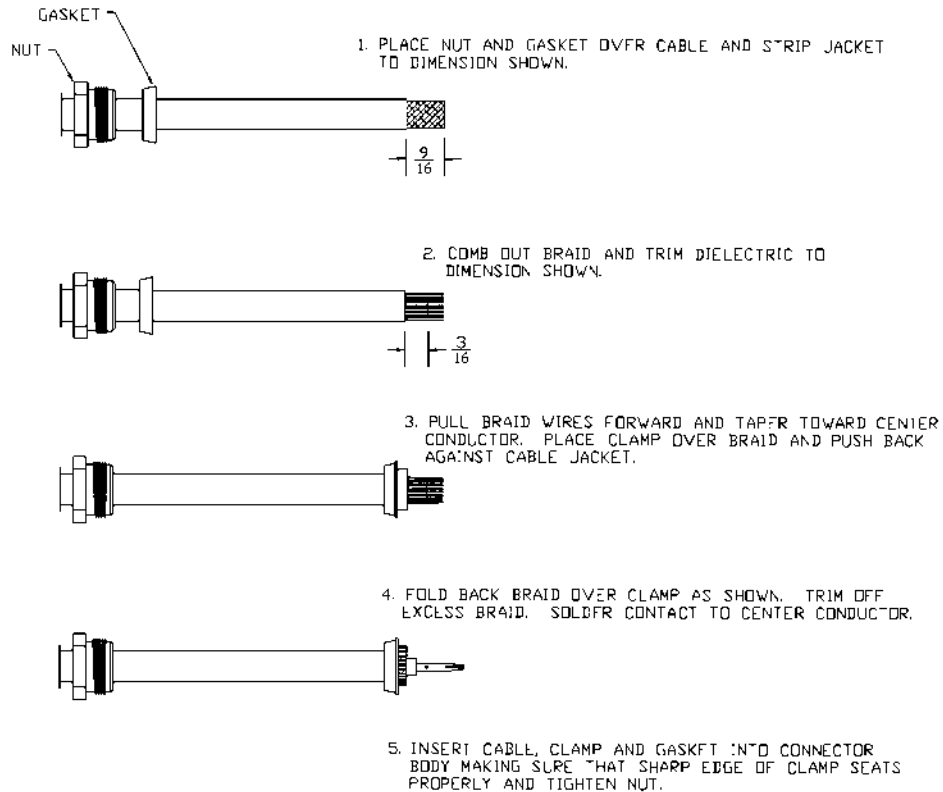

Figure 3-1. Coaxial Cable Installation

3. The card-edge connector may be used to terminate shield grounds to the 500 Series back plate.

CAUTION

4. Feed wires through the connector backshells before insertion into the 78, 44, and 25 pin connectors.
5. Contacts for the 78, 44 and 25 pin connectors must be crimped onto the individual wires of the aircraft wiring harness. The following tables list contact part numbers (for reference) and recommended crimp tools:

Table 3-1. Pin Contact Part Numbers

	78 pin conn (P5001/5050)	44 pin conn (P5006)	25 pin connector (P5002)		Shield ground connector
Connector Type	High Density Pin Contact		Standard Density	Socket Contact	.1" Pitch Card-edge
Wire Gauge	22-24 AWG		18 AWG	20-24 AWG	20-24 AWG
Garmin P/N	336-00021-00		336-00023-00	336-00022-00	336-00029-00
Military P/N	M39029/58-360		N/A	M39029/63-368	N/A
AMP	204370-2		N/A	205090-1	583853-4
Positronic	M39029/58-360		FC6018D	M39029/63-368	N/A
ITT Cannon	030-2042-000		See Note 3	031-1007-042	N/A

Table 3-2. Recommended Crimp Tools (or equivalent)

Connector Type	Wire Gauge	High Density		Standard Density			
		22-24 AWG		18 AWG		20-24 AWG	
	Hand Crimping Tool	Positioner	Insertion/ Extraction Tool	Positioner	Insertion/ Extraction Tool	Positioner	Insertion/ Extraction Tool
Military P/N	M22520/2-01	M22520/2-09	M81969/1-04	N/A	M81969/1-02	M22520/2-08	M81969/1-02
Positronic	9507	9502-3	M81969/1-04	9502-11	M81969/1-02	9502-5	M81969/1-02
ITT Cannon	995-0001-584	995-0001-739	N/A	N/A	N/A	995-0001-604	980-2000-426
AMP	601966-1	601966-6	91067-1	N/A	N/A	601966-5	91067-2
Daniels	AFM8	K42	M81969/1-04	K774	M81969/1-02	K13-1	M81969/1-02
Astro	615717	615725	M81969/1-04	N/A	M81969/1-02	615724	M81969/1-02

NOTES

1. Insertion/extraction tools from ITT Cannon are all plastic; others are plastic with metal tip.
2. Non-Garmin part numbers shown are not maintained by Garmin and consequently are subject to change without notice.
3. Alternate contacts for 18 AWG wire: As an alternative to the Positronic contacts listed (and provided in the installation kit), the installer may use contacts made by ITT Cannon under P/N 031-1007-001. These contacts require the use of a different crimp tool positioner than shown in the table, with the part numbers as follows: Daniels P/N K250, Astro P/N 616245, or ITT Cannon P/N 980-0005-722.
4. For the card-edge connector pin contacts, use AMP part number 90272-1 or equivalent crimping tool.

To prevent a possible short across the pins in the wiring harness, Teflon shrink tubing P/N 312-00005-05, provided in Connector Kit 011-00351-00 (P5002) covers the oversized power and ground pin contacts P/N 336-00023-00 (pins 11, 12, 21, 22) that protrude from the back of the connector shell. Before crimping the pins onto the wire:

1. Cut the tubing (312-00005-05) into 4 equal lengths.
2. Slide a short piece of the tubing over the wire.
3. Strip the wire and crimp the pin (336-00023-00) onto the wire.
4. Insert the pin into the connector shell.
5. Slide the tubing over the exposed portion of the pin and shrink using a heat gun.

3.7 RACK INSTALLATION

1. The back plate of the rack may optionally be removed for ease of mounting in the aircraft panel. To do so, remove the two #4-40 screws, tilt the back plate away from the tray, and then slide the back plate to the side.
2. Figures F-2 and F-3, starting on page F-5, shows outline dimensions for the aviation rack for the various 500 Series units. Install the rack in a rectangular 6.320” x 4.600” hole (or gap between units) in the instrument panel (refer to Figure F-6, page F-13). The lower-front lip of the rack should be flush with, or extend slightly beyond, the finished aircraft panel.

CAUTION

If the front lip of the mounting rack is behind the surface of the aircraft panel, the 500 Series unit connectors may not fully engage.

Make sure that no screw heads or other obstructions prevent the unit from fully engaging in the rack (refer to the “Connector Engagement Test,” section 5.3.1, page 5-19). Exercise caution when installing the rack into the instrument panel. The rack is designed to facilitate removal of the 500 Series for use in Demo Mode outside the aircraft. Deformation of the rack may make it difficult to install and remove the 500 Series unit.

3. Install the rack in the aircraft panel using six #6-32 flat head screws and six self-locking nuts. The screws are inserted from the inside through the holes in the sides of the rack.

-
4. If the back plate was previously removed (see step #1), replace the back plate by positioning the tabs on the back plate in the slots of the left side of the rack (viewing it from the cockpit) and attaching it by replacing the two #4-40 screws.

3.8 500 SERIES UNIT INSERTION AND REMOVAL

It may be necessary to insert the hex drive tool into the access hole and rotate the mechanism 90° counterclockwise to insure correct position prior to placing the unit in the rack. The 500 Series unit is installed in the rack by sliding it straight in until it stops, about 1 inch short of the final position. A 3/32" hex drive tool is then inserted into the access hole at the bottom of the unit face. Rotate the hex tool clockwise while pressing on the left side of the bezel until the unit is firmly seated in the rack.

To remove the unit from the rack, insert the hex drive tool into the access hole on the unit face and rotate counterclockwise until the unit is forced out about 3/8" and can be freely pulled from the rack.

Be sure not to over tighten the unit into the rack. The application of hex drive tool torque exceeding 15 in•lbs can damage the locking mechanism.

3.9 COM ANTENNA INSTALLATION CHECK (GNS 530)

Check for insertion loss and VSWR (voltage standing wave ratio). VSWR should be checked with an in-line type VSWR/wattmeter inserted in the coaxial transmission line between the transceiver and the antenna. The VSWR should be inserted as close to the transceiver as possible. When rack and harness buildup is performed in the shop, the coax termination may be provisioned by using a 6" inline BNC connection. This would be an acceptable place to insert the VSWR. Any problem with the antenna installation is most likely seen as high reflected power. A VSWR of 3:1 may result in up to a 50% loss in transmit power.

This page intentionally left blank

4. SYSTEM INTERCONNECTS

4.1 PIN FUNCTION LIST

4.1.1 P5001

View of J5001 connector from back of unit

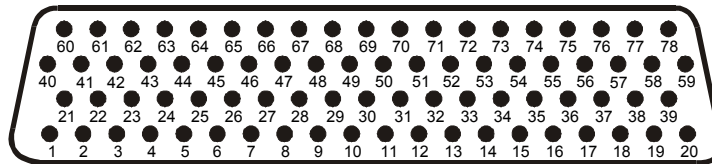

Pin	Pin Name	I/O
1	VLOC ANNUNCIATE	Out
2	GPS ANNUNCIATE	Out
3	WAYPOINT ANNUNCIATE	Out
4	TERMINAL ANNUNCIATE	Out
5	APPROACH ANNUNCIATE	Out
6	MESSAGE ANNUNCIATE	Out
7	OBS ANNUNCIATE	Out
8	SPARE ANNUNCIATE	Out
9	INTEGRITY ANNUNCIATE	Out
10	ANNUNCIATE D	Out
11	ANNUNCIATE E	Out
12	ALTITUDE ALARM ANNUNCIATE (Not implemented at time of publication)	Out
13	ANNUNCIATE F (Not implemented at time of publication)	Out
14	ILS/GPS APPROACH	Out
15	AIRCRAFT POWER 2*	In
16	TIME MARK OUT	Out
17	MAIN LATERAL SUPERFLAG	Out
18	MAIN VERTICAL SUPERFLAG	Out
19	AIRCRAFT POWER 1	In
20	AIRCRAFT POWER 1	In
21	MAIN +LEFT	Out
22	MAIN +RIGHT (2.5V COMMON)	Out
23	MAIN LATERAL +FLAG	Out
24	MAIN LATERAL -FLAG (2.5V COMMON)	Out
25	MAIN +TO	Out
26	MAIN +FROM (2.5V COMMON)	Out
27	MAIN +UP	Out
28	MAIN +DOWN (2.5V COMMON)	Out
29	MAIN VERTICAL +FLAG	Out
30	MAIN VERTICAL -FLAG (2.5V COMMON)	Out
31	MAIN OBS ROTOR C	Out
32	MAIN OBS ROTOR H (GROUND)	Out
33	MAIN OBS STATOR D	In
34	MAIN OBS STATOR E (2.5V COMMON OBS)	Out
35	MAIN OBS STATOR F	In
36	MAIN OBS STATOR G (2.5V COMMON OBS)	Out

* Applies only to GNS 530 part numbers 011-00550-30, 011-00940-10, 011-00940-11 GNS 530A 011-00835-10, 011-00864-10, 011-00864-11 and GPS 500 part number 011-00562-10, 011-00863-10, 011-00863-11. For applications requiring secondary or alternate power bus input.

Connector P5001, continued		
Pin	Pin Name	I/O
37	ALTITUDE ALARM AUDIO HI (Not implemented at time of publication)	Out
38	ALTITUDE ALARM AUDIO LO (Not implemented at time of publication)	Out
39	LIGHTING BUS HI	In
40	LIGHTING BUS LO	In
41	GPS RS-232 OUT 3	In
42	GPS RS-232 IN 3	Out
43	MAIN OBI CLOCK	Out
44	MAIN OBI DATA	Out
45	MAIN OBI SYNC	Out
46	GPS ARINC 429 OUT A	Out
47	GPS ARINC 429 OUT B	Out
48	GPS ARINC 429 IN 1 A	In
49	GPS ARINC 429 IN 1 B	In
50	GPS ARINC 429 IN 2 A	In
51	GPS ARINC 429 IN 2 B	In
52	TAWS AUDIO HI	Out
53	TAWS AUDIO LO	--
54	GPS RS-232 OUT 4	Out
55	GPS RS-232 IN 4	In
56	GPS RS-232 OUT 1	Out
57	GPS RS-232 IN 1	In
58	GPS RS-232 OUT 2	Out
59	GPS RS-232 IN 2	In
60	ALTITUDE COMMON (GROUND)	Out
61	ALTITUDE C4	In
62	ALTITUDE C2	In
63	ALTITUDE C1	In
64	ALTITUDE B4	In
65	ALTITUDE B2	In
66	ALTITUDE B1	In
67	ALTITUDE A4	In
68	ALTITUDE A2	In
69	ALTITUDE A1	In
70	ALTITUDE D4	In
71	OBS MODE SELECT	In
72	AIRCRAFT POWER 2*	In
73	CDI SOURCE SELECT	In
74	RESERVED	--
75	DEMO MODE SELECT	In
76	RESERVED	--
77	AIRCRAFT GROUND	--
78	AIRCRAFT GROUND	--

* Applies only to GNS 530 part numbers 011-00550-30, 011-00940-10, 011-00940-11 GNS 530A 011-00835-10, 011-00864-10, 011-00864-11 and GPS 500 part number 011-00562-10, 011-00863-10, 011-00863-11. For applications requiring secondary or alternate power bus input.

4.1.2 P5050 (with TAWS)

View of J5050 connector from back of unit

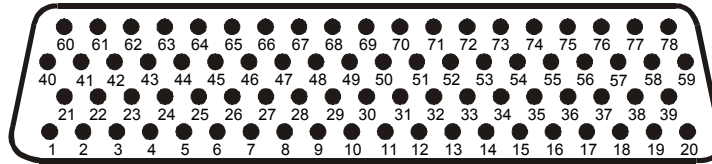

Pin	Pin Name	I/O
1	TAWS INHIBIT OUT	Out
2	TAWS AUDIO INHIBIT IN	In
3	SPARE INPUT 4	In
4	SPARE INPUT 3	In
5	SPARE INPUT 2	In
6	SPARE INPUT 1	In
7	RESERVED	--
8	RESERVED	--
9	TERRAIN NOT AVAILABLE ANNUNCIATE	Out
10	TERRAIN WARNING ANNUNCIATE	Out
11	TERRAIN CAUTION ANNUNCIATE	Out
12	TAWS INHIBIT ANNUNCIATE	Out
13	SPARE ANNUN 2	Out
14	SPARE ANNUN 1	Out
15	TAWS AUDIO ACTIVE OUT	Out
16	RESERVED	--
17-21	GROUND	--
22-59	NO CONNECT	--
60	RS232_OUT_5	Out
61	RS232_IN_5	In
62	NO CONNECT	--
63	NO CONNECT	--
64	GROUND	--
65-78	NO CONNECT	--

4.1.3 P5050 (without TAWS)

Pin	Pin Name	I/O
1-59	SPARES	--
60	GPS RS-232 OUT 5	Out
61	GPS RS-232 IN 5	In
62	GPS RS-232 OUT 6	Out
63	GPS RS-232 IN 6	In
64-78	SPARES	--

4.1.4 P5002 (GNS 530 Only)

View of J5002 connector from back of unit

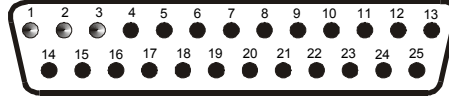

Pin	Pin Name	I/O
1	RESERVED	--
2	RESERVED	--
3	RESERVED	--
4	COM MIC KEY	In
5	INTERCOM MIC HI	In
6	COM MIC AUDIO HI	In
7	500Ω COM AUDIO HI	Out
8	RESERVED	--
9	RESERVED	--
10	RESERVED	--
11	AIRCRAFT POWER	In
12	AIRCRAFT POWER	In
13	RESERVED	--
14	TRANSMIT INTERLOCK	In
15	COM REMOTE TRANSFER	In
16	SPARE	--
17	INTERCOM MIC LO	In
18	COM MIC AUDIO LO	In
19	500Ω COM AUDIO LO	Out
20	RESERVED	--
21	AIRCRAFT GROUND	--
22	AIRCRAFT GROUND	--
23	RESERVED	--
24	RESERVED	--
25	RESERVED	--

4.1.5 P5006 (GNS 530 Only)

View of J5006 connector from back of unit

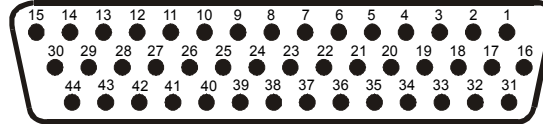

Pin	Pin Name	I/O
1	VOR/LOC +TO	Out
2	VOR/LOC +FROM (VOR/LOC COMMON)	Out
3	VOR/LOC +FLAG	Out
4	VOR/LOC -FLAG (VOR/LOC COMMON)	Out
5	VOR/LOC +LEFT	Out
6	VOR/LOC +RIGHT (VOR/LOC COMMON)	Out
7	RESERVED	--
8	VOR/LOC COMPOSITE OUT	Out
9	VOR OBS ROTOR C	Out
10	VOR OBS ROTOR H (GROUND)	Out
11	VOR OBS STATOR E/G (VOR/LOC COMMON)	In
12	VOR OBS STATOR F	In
13	VOR OBS STATOR D	In
14	PARALLEL DME - 8MHZ	Out
15	VOR/LOC SUPERFLAG	Out
16	500Ω VOR/ILS AUDIO HI	Out
17	500Ω VOR/ILS AUDIO LO	Out
18	SERIAL DME CLOCK	Out
19	SERIAL DME DATA	Out
20	SER DME - CHAN REQ/PAR DME - 4MHZ	I/O
21	SER DME - RNAV MODE/PAR DME - 2MHZ	I/O
22	DME COMMON	In
23	VOR/ILS ARINC 429 OUT B	Out
24	VOR/ILS ARINC 429 OUT A	Out
25	VOR OBI CLOCK	Out
26	VOR OBI SYNC	Out
27	VOR OBI DATA	Out
28	VLOC REMOTE TRANSFER	In
29	ILS ENERGIZE	Out
30	GLIDESLOPE +FLAG	Out
31	GLIDESLOPE +DOWN/-FLAG (GLIDESLOPE COMMON)	Out
32	GLIDESLOPE +UP	Out
33	PARALLEL DME - 1MHZ	Out
34	RESERVED	--
35	VOR/ILS ARINC 429 IN B	In
36	VOR/ILS ARINC 429 IN A	In
37	PARALLEL DME - 800KHZ	Out
38	GLIDESLOPE SUPERFLAG	Out
39	PARALLEL DME - 400KHZ	Out
40	PARALLEL DME - 200KHZ	Out
41	AIRCRAFT GROUND	--
42	PARALLEL DME - 100KHZ	Out
43	PARALLEL DME - 50KHZ	Out
44	AIRCRAFT POWER	In

4.2 POWER, LIGHTING, AND ANTENNAS

4.2.1 Power, Lighting, and Antennas Function

The section covers the Power Input requirements, Lighting Bus input, and Antenna connections.

4.2.2 Power, Lighting, and Antennas Electrical Characteristics

Aircraft Power

Pin Name	Connector	Pin	I/O
AIRCRAFT POWER 1	P5001	19	In
AIRCRAFT POWER 1	P5001	20	In
AIRCRAFT POWER 2*	P5001	15	In
AIRCRAFT POWER 2*	P5001	72	In
AIRCRAFT POWER	P5002	11	In
AIRCRAFT POWER	P5002	12	In
AIRCRAFT POWER	P5006	44	In
AIRCRAFT GROUND	P5001	77	--
AIRCRAFT GROUND	P5001	78	--
AIRCRAFT GROUND	P5002	21	--
AIRCRAFT GROUND	P5002	22	--
AIRCRAFT GROUND	P5006	41	--

* Applies only to GNS 530 part numbers 011-00550-30, 011-00940-10, 011-00940-11 GNS 530A 011-00835-10, 011-00864-10, 011-00864-11 and GPS 500 part number 011-00562-10, 011-00863-10, 011-00863-11. For applications requiring secondary or alternate power bus input.

CAUTION

To operate the GNS 530 P/N 011-00550-00 COM transceiver in a 14-volt aircraft, A 14 to 28 volt converter such as a KGS Electronics models RB-126 or UC-14-28 or equivalent must be used. The voltage converter should include exactly one short-circuit protection device on its output, such as a circuit breaker. P5002-11 and P5002-12 supply power to the COM transmitter. The other power input pins (P5001-19, P5001-20, and P5006-44) accept 11-33 Vdc. GNS 530 P/N 011-00550-10 and 011-00550-30 accepts 11-33 Vdc on all power inputs. Refer to Figure F-10 on page F-21.

A power connection on P5006-44 is only required if NAV SUPERFLAG or G/S SUPERFLAG is utilized.

The power inputs P5001-19 and P5001-20 provide power for all functions of the 500 Series unit except the COM transmitter and the NAV & G/S SUPERFLAG outputs.

4.2.2.2 Lighting Bus

Pin Name	Connector	Pin	I/O
LIGHTING BUS HI	P5001	39	In
LIGHTING BUS LO	P5001	40	In

The 500 Series unit can be configured to track 28 Vdc, 14 Vdc, 5 Vdc or 5 Vac lighting buses using these inputs. Alternatively, the 500 Series unit can automatically adjust for ambient lighting conditions based on the photocell. Refer to section 5.2.6.

4.2.2.3 Antennas

Pin Name	Connector	I/O
GPS ANTENNA	P5003	In
COM ANTENNA	P5004	I/O
VOR/LOC ANTENNA	P5005	In
GLIDESLOPE ANTENNA	P5007	In

4.2.3 Power, Lighting, and Antennas Configuration

Refer to section 5.2.6 for lighting configuration.

4.2.4 Power, Lighting, and Antennas Calibration and Checkout

Refer to section 3.9 for the COM antenna checkout.

4.2.5 Power, Lighting, and Antennas Interconnect

Refer to Figure F-10 on page F-21 for the power, lighting, and antennas interconnect.

4.3 ALTIMETER

4.3.1 Altimeter Function

Altitude input is required for GPS RAIM calculations, and is useful for advisory vertical navigation (VNAV) calculations.

4.3.2 Altimeter Electrical Characteristics

Pin Name	Connector	Pin	I/O
ALTITUDE D4	P5001	70	In
ALTITUDE A1	P5001	69	In
ALTITUDE A2	P5001	68	In
ALTITUDE A4	P5001	67	In
ALTITUDE B1	P5001	66	In
ALTITUDE B2	P5001	65	In
ALTITUDE B4	P5001	64	In
ALTITUDE C1	P5001	63	In
ALTITUDE C2	P5001	62	In
ALTITUDE C4	P5001	61	In
ALTITUDE COMMON	P5001	60	In

These inputs are considered active if either the voltage to ground is <1.9 V or the resistance to ground is <375 Ω . These inputs are considered inactive if the voltage to ground is 11-33 Vdc.

NOTE

Some transponders and other altitude encoder receivers do not have internal isolation diodes to prevent the unit from pulling the encoder lines to ground when the unit is off. These units require a diode added to the installation harness for each encoder line. The anode should be connected on the receiving unit's side and the cathode should be connected on the encoder side. A set of diodes is required for each unit without internal diodes. The 500 Series unit includes internal diodes for isolation of the encoder lines.

4.3.3 Altimeter Configuration

None.

4.3.4 Altimeter Calibration and Checkout

Refer to section 5.2.8 for the gray code altitude checkout.

4.3.5 Altimeter Interconnect

Refer to Figure F-11 on page F-23 and Figure F-12 on page F-25 for the altimeter interconnect.

4.4 MAIN INDICATOR

4.4.1 Main Indicator Function

The Main Indicator displays both lateral and vertical deviation from selected course, To/From indications, lateral and vertical flags and superflags.

The “CDI” key on the bezel of the GNS 530 takes the place of remote “NAV/GPS” switches, and is used to toggle between display of GPS and VOR/ILS navigation display on a remote indicator. The Navigation source is announced on the display above the ‘CDI’ key. The Navigation method is optionally announced externally by connecting to the VLOC ANNUNCIATE output (P5001-1) and GPS ANNUNCIATE output (P5001-2). GPS and VOR/ILS navigation may be toggled externally when the CDI SOURCE SELECT input (P5001-73) is momentarily grounded. See section 4.5 for more information on the external annunciators and switches.

An OBS resolver connection to the GPS is preferred, but not required. For the GNS 530, an OBS resolver typically is connected to the MAIN OBS inputs for use with the GNS 530 VOR receiver.

4.4.2 Main Indicator Electrical Characteristics

4.4.2.1 Deviation

Pin Name	Connector	Pin	I/O
MAIN +LEFT	P5001	21	Out
MAIN +RIGHT (2.5V COMMON)	P5001	22	Out
MAIN +UP	P5001	27	Out
MAIN +DOWN (2.5V COMMON)	P5001	28	Out

The deviation output is capable of driving up to three 1000 Ω meter loads with ± 150 mVdc $\pm 10\%$ for full-scale deflection. The drive circuit provides for more than full-scale deflection with a maximum course deviation output voltage of ± 300 mVdc $\pm 10\%$.

4.4.2.2 TO/FROM

Pin Name	Connector	Pin	I/O
MAIN +TO	P5001	25	Out
MAIN +FROM (2.5V COMMON)	P5001	26	Out

The output is capable of driving up to three 200 Ω meter loads. When indicating TO, MAIN +TO is $+190 \pm 40$ mVdc with respect to MAIN +FROM. When indicating FROM, MAIN +TO is -190 ± 40 mVdc with respect to MAIN +FROM. When invalid information is present (Flag IN VIEW) the TO/FROM output is 0 ± 10 mVdc.

4.4.2.3 Flag

Pin Name	Connector	Pin	I/O
MAIN LATERAL +FLAG	P5001	23	Out
MAIN LATERAL -FLAG (2.5V COMMON)	P5001	24	Out
MAIN VERTICAL +FLAG	P5001	29	Out
MAIN VERTICAL -FLAG (2.5V COMMON)	P5001	30	Out

The Flag output is capable of driving up to three 1000 Ω meter loads. When valid information is present (Flag OUT OF VIEW) the Flag output is 375 ± 80 mVdc. When invalid information is present (Flag IN VIEW) the Flag output is 0 ± 25 mVdc.

4.4.2.4 Superflags

Pin Name	Connector	Pin	I/O
MAIN LATERAL SUPERFLAG	P5001	17	Out
MAIN VERTICAL SUPERFLAG	P5001	18	Out

The output supplies not less than 500 mA on a 28 volt system and 250 mA on a 14 volt system with the output voltage not less than (AIRCRAFT POWER –1.5 Vdc) when the flag is to be OUT OF VIEW. The output voltage with respect to ground is less than 0.25 Vdc when the flag is to be IN VIEW.

4.4.2.5 OBS

Pin Name	Connector	Pin	I/O
MAIN OBS ROTOR C	P5001	31	Out
MAIN OBS ROTOR H (GROUND)	P5001	32	Out
MAIN OBS STATOR D	P5001	33	In
MAIN OBS STATOR E (2.5V COMMON OBS)	P5001	34	Out
MAIN OBS STATOR F	P5001	35	In
MAIN OBS STATOR G (2.5V COMMON OBS)	P5001	36	Out

MAIN OBS ROTOR C and H are a buffered output that is intended to drive the OBS rotors. MAIN OBS STATOR D and MAIN OBS STATOR F are each phase and amplitude shifted version of the MAIN ROTOR C output. Each pair is intended to read one of the two windings of the indicator's OBS stator.

4.4.3 Main Indicator Configuration

Refer to section 5.2.9 for the main CDI/OBS configuration.

4.4.4 Main Indicator Calibration and Checkout

Refer to section 5.2.9 for the main CDI/OBS checkout.

4.4.5 Main Indicator Interconnect

Refer to Figure F-12 on page F-25 for the generic main indicator interconnect. Refer to Figure F-13 on page F-27 for the interconnect between a GNS 530 and a Bendix/King KI 209A. Refer to Figure F-14 on page F-29 for the interconnect between a GPS 500 and a Bendix/King KI 208A.

4.5 ANNUNCIATORS/SWITCHES

4.5.1 Annunciators/Switches Function

NOTE

Initial certification of the 500 Series units was accomplished without use of any remote switches or annunciators, since the same switching and annunciation is available on the front panel of the 500 Series unit. However, if the 500 Series unit is not installed in the pilot's normal field of view, some or all of the remote switches and annunciators may be required by your certification agency. Appendix B includes an FAA letter granting permission to install GNS 530 without external switches and annunciators.

4.5.1.1 MESSAGE ANNUNCIATE

When a new status message is available, the Message Annunciator flashes. When status messages remain effective, the Message Annunciator illuminates.

4.5.1.2 WAYPOINT ANNUNCIATE

The waypoint annunciator output is driven in the following manner:

1. When the aircraft is within 10 seconds of reaching the turning point for a course change, the waypoint annunciator flashes.
2. When the aircraft is in a turn, the waypoint annunciator illuminates and remains illuminated until the turn is completed.
3. When a user arrival alarm is set and the aircraft is within the circle defined by the arrival alarm radius at the arrival waypoint, the waypoint annunciator flashes for 10 seconds.
4. When a user arrival alarm is not set and the aircraft is within 10 seconds of reaching the arrival waypoint, the waypoint annunciator flashes.

4.5.1.3 CDI SOURCE SELECT (GNS 530 Only)

This discrete input may be used to toggle between display of GPS and VOR/LOC/Glideslope information on the MAIN external CDI/HSI. A momentary low on this pin performs the same function as pressing the 'CDI' key on the GNS 530 bezel.

4.5.1.4 VLOC ANNUNCIATE (GNS 530 Only)

This annunciator output is driven when the unit is configured with a single CDI/HSI and the VOR/ILS data is being displayed on the CDI/HSI. This output parallels the VLOC annunciator on the display.

4.5.1.5 GPS ANNUNCIATE (GNS 530 Only)

This annunciator output is driven when the unit is configured with a single CDI/HSI and the GPS data is being displayed on the CDI/HSI. This output parallels the GPS annunciation on the display.

4.5.1.6 OBS MODE SELECT

This discrete input may be used to toggle between GPS OBS and GPS AUTO modes of operation. A momentary low on this pin performs the same function as pressing the 'OBS' key on the 500 Series unit.

4.5.1.7 OBS ANNUNCIATE

This annunciator output is driven to indicate GPS OBS mode of operation. This output is active when the OBS or SUSP annunciation is on the display.

4.5.1.8 TERMINAL ANNUNCIATE

When performing approach navigation, the terminal annunciator is illuminated when operating within 30 nautical miles of the departure or arrival airport and the CDI scale is the equivalent or 1.0 nm or less.

4.5.1.9 APPROACH ANNUNCIATE

When performing approach navigation, the approach annunciator illuminates when approach is active.

4.5.1.10 INTEGRITY ANNUNCIATE

The integrity annunciator illuminates when the GPS receiver detects a position error, or is unable to calculate the integrity of the position.

4.5.1.11 ILS/GPS APPROACH Output

Sinks 500 mA when GPS navigation is selected and GPS approach is active or when VLOC navigation is selected and an ILS channel has been selected. This output may be connected to the ILS Engage input of an autopilot or flight director to provide higher autopilot gain while the 500 Series unit is operating in the ILS or GPS Approach modes of operation.

4.5.1.12 DEMO MODE SELECT

This discrete input may be used to select Demo Mode on the 500 Series unit. A low on this pin at time of unit power-up invokes the Demo Mode. Demo Mode allows the 500 Series unit to simulate reception of GPS satellite signals.

CAUTION

Do not connect DEMO MODE SELECT in an aircraft installation.

4.5.1.13 TIME MARK OUT

Time Mark Out is a time reference pulse output once per second, derived from GPS satellite signals.

4.5.2 Annunciators/Switches Electrical Characteristics

4.5.2.1 Annunciators

Pin Name	Connector	Pin	I/O
VLOC ANNUNCIATE	P5001	1	Out
GPS ANNUNCIATE	P5001	2	Out
WAYPOINT ANNUNCIATE	P5001	3	Out
TERMINAL ANNUNCIATE	P5001	4	Out
APPROACH ANNUNCIATE	P5001	5	Out
MESSAGE ANNUNCIATE	P5001	6	Out
OBS ANNUNCIATE	P5001	7	Out
INTEGRITY ANNUNCIATE	P5001	9	Out
ILS/GPS APPROACH	P5001	14	Out

All outputs sink up to 500 mA when activated.

4.5.2.2 Switch Inputs

Pin Name	Connector	Pin	I/O
OBS MODE SELECT	P5001	71	In
CDI SOURCE SELECT	P5001	73	In
DEMO MODE SELECT	P5001	75	In

These inputs are considered active if either the voltage to ground is <1.9 V or the resistance to ground is <375 Ω . These inputs are considered inactive if the voltage to ground is 11-33 Vdc.

4.5.2.3 TIME MARK OUT

Pin Name	Connector	Pin	I/O
TIME MARK OUT	P5001	16	Out

TIME MARK OUT outputs a 1 ms \pm 1 μ s wide pulse once every 1.0 s \pm 2 ms. TIME MARK OUT is a logic level output, capable of sourcing 1 mA at up greater than 3.8 V and sinking 1 mA at less than 0.4 V.

4.5.3 Annunciators/Switches Configuration

None.

4.5.4 Annunciators/Switches Calibration and Checkout

Refer to section 5.2.8 for the annunciators/switches checkout.

4.5.5 Annunciators/Switches Interconnect

Refer to Figure F-15 on page F-31 for the annunciators/switches interconnect.

4.6 SERIAL DATA

4.6.1 Serial Data Function

4.6.1.1 RS-232

The 500 Series unit is capable of interfacing with other aviation instruments by transmitting RS-232 Type 1 (often known as ARNAV format) and Type 2 (often known as Northstar format) data on the GPS RS-232 OUT 1 port. The data consists of the following (refer to Appendix C for a detailed data format description):

Current latitude, longitude, and GPS altitude in feet (see Note below)
Current velocity vector (ground speed and direction of velocity vector over the ground)
Distance to waypoint
Cross track error
Desired track
Destination waypoint identifier
Bearing to destination waypoint
Magnetic variation
Navigation and warning status
Waypoint sequence in route
Waypoint position (latitude and longitude) and magnetic variation

NOTE

Aviation RS-232 data may be transmitted with or without the current GPS altitude in feet. Refer to section 5.2.2.

The 500 Series unit can receive pressure altitude, air data, and fuel data from certain systems on the GPS RS-232 IN 1 port.

The 500 Series unit can communicate with a Ryan TCAD 9900B system using the GPS RS-232 OUT 2 and GPS RS-232 IN 2 lines to display traffic information on the 500 Series unit.

If two 400 or 500 Series units are installed in an aircraft, the GPS RS-232 OUT 3 and GPS RS-232 IN 3 lines may be cross-connected to crossfill flight plans and user-defined waypoints from one 400 or 500 Series unit to the other.

The 500 Series unit can communicate with a BF Goodrich WX-500 Stormscope using the GPS RS-232 OUT 4 and GPS RS-232 IN 4 lines to display lightning strike information on the 500 Series unit.

4.6.1.2 ARINC 429

The data output on the GPS ARINC 429 OUT port depends on the configuration (refer to section 5.2.1). Below is a list of the configurations and the labels output for each one:

1. ARINC 429
2. GAMA 429
3. GAMA 429 Graphics
4. GAMA 429 Graphics w/Int

Label #	Parameter Name	1	2	3	4
001	Distance to Go (BCD)	•	•	•	•
002	Time to Go (BCD)	•	•	•	•
012	Ground Speed (BCD)	•	•	•	•
074G	Data Record Header		•	•	•
075G	Active Wpt From/To Data		•	•	•
100	Selected Course 1	•			
100G	Selected Course 1		•	•	•
113G	Message Checksum		•	•	•
114	Desired Track (True)	•	•	•	•

Label #	Parameter Name	1	2	3	4
115	Waypoint Bearing (True)	•	•	•	•
116	Cross Track Distance	•			
116G	Cross Track Distance		•	•	•
121	Horizontal Command (to Autopilot)	•	•	•	•
125	Greenwich Mean Time (BCD)	•	•	•	•
147G	Magnetic Variation		•	•	•
251	Distance to Go	•			
251G	Distance to Go		•	•	•
252	Time to Go	•	•	•	•
260G	Date (BCD)		•	•	•
261G	GPS Discrete Word 1		•	•	•
275G	LRN Status Word		•	•	•
300G	Station Declination, Type, and Class		•	•	•
303	Message Length/Type/Number		•	•	•
304G	Message Characters 1-3		•	•	•
305G	Message Characters 4-6		•	•	•
306G	NAV/Waypoint/Airport Latitude		•	•	•
307G	NAV/Waypoint/Airport Longitude		•	•	•
310	Present Position Latitude	•	•	•	•
311	Present Position Longitude	•	•	•	•
312	Ground Speed	•	•	•	•
313	Track Angle (True)	•	•	•	•
314	True Heading	•	•	•	•
315	Wind Speed	•	•	•	•
316	Wind Angle (True)	•	•	•	•
320	Magnetic Heading	•	•	•	•
321	Drift Angle	•	•	•	•
326G	Lateral Scale Factor		•	•	•
330	Conic Arc Inbound Course			•	•
331	Conic Arc Radius			•	•
332	Conic Arc Course Change Angle			•	•
333	Airport Runway Azimuth			•	•
334	Airport Runway Length in Feet			•	•
335	Left/Right Hand Holding Pattern Azimuth			•	•
340	Left/Right Hand Procedure Turn Azimuth			•	•
351G	Distance To Destination (Via Flight Plan)		•	•	•
352G	Estimated Time To Destination (Via Flight Plan)		•	•	•
371G	Specific Equipment ID		•	•	•
377	Equipment Hex ID Code	•	•	•	•

The following labels are output on the VOR/ILS ARINC 429 OUT port:

Label #	Parameter Name
034G	VOR/ILS Frequency (BCD)
035G	DME Frequency (BCD)
100G	Selected Course #1
173	Localizer Deviation
174	Glideslope Deviation
222	VOR Omnibearing
371G	Specific Equipment ID
377	Equipment Hex ID Code

The labels recognized on the GPS ARINC 429 IN 1 or GPS ARINC 429 IN 2 ports depend on the configuration (refer to section 5.2.1).

The 500 Series unit can receive traffic data from a Garmin GTX 330 or a BF Goodrich SKY497 Skywatch system using the GPS ARINC 429 IN 1 or GPS ARINC 429 IN 2 ports, in order to display traffic information on the 500 Series unit.

4.6.2 Serial Data Electrical Characteristics

4.6.2.1 RS-232

Pin Name	Connector	Pin	I/O
GPS RS-232 OUT 1	P5001	56	Out
GPS RS-232 IN 1	P5001	57	In
GPS RS-232 OUT 2	P5001	58	Out
GPS RS-232 IN 2	P5001	59	In
GPS RS-232 OUT 3	P5001	41	Out
GPS RS-232 IN 3	P5001	42	In
GPS RS-232 OUT 4	P5001	54	Out
GPS RS-232 IN 4	P5001	55	In

The RS-232 outputs conform to EIA Standard RS-232C with an output voltage swing of at least ± 5 V when driving a standard RS-232 load.

4.6.2.2 ARINC 429

Pin Name	Connector	Pin	I/O
GPS ARINC 429 OUT A	P5001	46	Out
GPS ARINC 429 OUT B	P5001	47	Out
GPS ARINC 429 IN 1 A	P5001	48	In
GPS ARINC 429 IN 1 B	P5001	49	In
GPS ARINC 429 IN 2 A	P5001	50	In
GPS ARINC 429 IN 2 B	P5001	51	In
VOR/ILS ARINC 429 OUT A	P5006	24	Out
VOR/ILS ARINC 429 OUT B	P5006	23	Out
VOR/ILS ARINC 429 IN A	P5006	36	In
VOR/ILS ARINC 429 IN B	P5006	35	In

The GPS and VOR/ILS ARINC 429 outputs conform to ARINC 429 electrical specifications when loaded with up to 5 standard ARINC 429 receivers.

4.6.3 Serial Data Configuration

Refer to section 5.2.1 for the main (GPS) ARINC 429 configuration. Refer to sections 5.2.14, 5.2.15, and 5.2.16 for the Stormscope configuration. Refer to section 5.2.17 for the Skywatch configuration. Refer to sections 5.2.17 and 5.2.18 for the TCAD configuration. If the GDL 49 satellite data link transceiver has been installed, refer to the GDL 49 Installation Manual (190-00231-00) for Configuration Mode Operations. Refer to section 5.2.1 for information on Garmin GTX 330 configuration.

4.6.4 Serial Data Calibration and Checkout

Refer to section 5.3.2 for the serial data checkout. Refer to sections 5.2.14, 5.2.15, and 5.2.16 for the Stormscope checkout. Refer to section 5.2.17 for the Skywatch checkout. Refer to sections 5.2.17 and 5.2.18 for the TCAD checkout.

4.6.5 Serial Data Interconnect

Refer to Figure F-16 on page F-33 for the RS-232 serial data interconnect. Refer to Figure F-17 on page F-35 for the ARINC 429 Bendix/King EFS 40/50 interconnect. Refer to Figures F-18, F-19 and F-20 starting on page F-37 for the ARINC 429 Sandel EHSI interconnect. Refer to Figure F-21 on page F-43 for the ARINC 429 air data/IRU/AHRS interconnect. Refer to Figure F-22 on page F-45 for the ARINC 429 flight control interconnect. Refer to Figure F-23 on page F-47 for the Traffic Advisory System Interconnect, and Figure F-25 on page F-51 for the Weather and Terrain Interconnect.

4.7 COM/VOR/ILS AUDIO (GNS 530 ONLY)

4.7.1 COM/VOR/ILS Audio Function

Activation of COM MIC KEY enables COM MIC AUDIO and causes the transceiver to transmit.

500 Ω COM AUDIO and 500 Ω VOR/ILS AUDIO are 100 mW audio outputs that are intended to drive a headset or an audio panel.

Momentarily depressing the COM REMOTE TRANSFER button toggles the active and standby COM frequencies. Momentarily depressing the VLOC REMOTE TRANSFER button toggles the active and standby VLOC frequencies.

The COM REMOTE TRANSFER input may be used for EMERGENCY operation of the COM transmitter. If the remote transfer switch is depressed for two seconds, the active COM frequency changes to 121.50 MHz. Once the emergency frequency is activated through COM REMOTE TRANSFER, GNS 530 COM transceivers with Mod 2 incorporated, ignore inputs from the front panel controls for COM selections only. The pilot may exit this independent mode—restoring COM selection control to the front panel knobs and buttons—by momentarily depressing the COM REMOTE TRANSFER switch.

When TRANSMIT INTERLOCK is active, the GNS 530 COM receiver sensitivity is decreased. This input is intended to reduce interference from other transmitters in the aircraft. The TRANSMIT INTERLOCK input should be connected to the PTT input of other transmitters in the aircraft. If connected to multiple PTT inputs, these connections must include diode isolation or multiple radios transmit simultaneously.

4.7.2 COM/VOR/ILS Audio Electrical Characteristics

4.7.2.1 COM MIC KEY

Pin Name	Connector	Pin	I/O
COM MIC KEY	P5002	4	In

This input is considered active if either the voltage to ground is <1.9 V or the resistance to ground is <375 Ω . This input is considered inactive if the voltage to ground is 11-33 Vdc.

4.7.2.2 COM MIC AUDIO, INTERCOM MIC AUDIO

Pin Name	Connector	Pin	I/O
COM MIC AUDIO HI	P5002	6	In
COM MIC AUDIO LO	P5002	18	In
INTERCOM MIC HI	P5002	5	In
INTERCOM MIC LO	P5002	17	In

COM MIC AUDIO and INTERCOM MIC each have a 520 Ω AC input impedance and supply the microphone with a 9 V bias through 620 Ω .

COM MIC AUDIO is set in the factory so that 275 mVrms modulates the transmitter to 80% nominally. The microphone gain adjustment is made through Configuration Mode.

When a 125 mVrms signal at 1000 Hz is applied to the INTERCOM MIC input, the level on the COM AUDIO output is not less than 7.07 Vrms.

4.7.2.3 COM AUDIO, VOR/ILS AUDIO

Pin Name	Connector	Pin	I/O
500Ω COM AUDIO HI	P5002	7	Out
500Ω COM AUDIO LO	P5002	19	Out
500Ω VOR/ILS AUDIO HI	P5006	16	Out
500Ω VOR/ILS AUDIO LO	P5006	17	Out

500Ω COM AUDIO and 500Ω VOR/ILS AUDIO each supply 100 mW into a 500 Ω load. These are balanced outputs and the LO output must be connected.

500Ω COM AUDIO is the summation of the COM receiver audio, COM sidetone audio, and INTERCOM MIC audio.

4.7.2.4 DISCRETE INPUTS

Pin Name	Connector	Pin	I/O
TRANSMIT INTERLOCK	P5002	14	In
COM REMOTE TRANSFER	P5002	15	In
VLOC REMOTE TRANSFER	P5006	28	In

These inputs are considered active if either the voltage to ground is <1.9 V or the resistance to ground is <375 Ω. These inputs are considered inactive if the voltage to ground is 11-33 Vdc.

COM REMOTE TRANSFER and VLOC REMOTE TRANSFER are momentary inputs.

4.7.3 COM/VOR/ILS Audio Configuration

None.

4.7.4 COM/VOR/ILS Audio Calibration and Checkout

Refer to section 5.2.10 for the COM calibration.

4.7.5 COM/VOR/ILS Audio Interconnect

Refer to Figure F-26 on page F-53 for the audio panel interconnect.

4.8 VOR/ILS INDICATOR (GNS 530 ONLY)

4.8.1 VOR/ILS Indicator Function

NOTE

Because the GNS 530 includes a “CDI” button that performs switching between GPS and VOR/ILS on a remote indicator, it is seldom necessary to use these outputs to drive an indicator. It is only necessary when it is desired for a separate indicator to display VOR/ILS deviation full-time (regardless of the “CDI” button status).

The VOR/ILS indicator displays both lateral and vertical, To/From indications, lateral and vertical flags and superflags. GNS 530 connector 5006 always outputs the VOR/Localizer/Glideslope navigation information. The VOR/ILS pins on GNS 530 connector 5006 are used to drive an indicator that displays VOR/ILS information at all times, regardless of the CDI selection on the GNS 530.

VOR/LOC COMPOSITE OUT is a standard VOR/Localizer Composite output signal which may be used to drive the Left/Right, TO/FROM, and Flag indications of certain navigation indicators that contain an internal converter.

The ILS ENERGIZE output goes low when the VLOC frequency is channeled to a localizer channel.

4.8.2 VOR/ILS Indicator Electrical Characteristics

4.8.2.1 Superflags

Pin Name	Connector	Pin	I/O
VOR/LOC SUPERFLAG	P5006	15	Out
GLIDESLOPE SUPERFLAG	P5006	38	Out

The output supplies not less than 500 mA on a 28 volt system and 250 mA on a 14 volt system with the output voltage not less than (AIRCRAFT POWER -3 Vdc) when the flag is to be OUT OF VIEW. The output voltage with respect to ground is less than 3 Vdc when the flag is to be IN VIEW.

4.8.2.2 Deviation

Pin Name	Connector	Pin	I/O
VOR/LOC +LEFT	P5006	5	Out
VOR/LOC +RIGHT (VOR/LOC COMMON)	P5006	6	Out
GLIDESLOPE +UP	P5006	32	Out
GLIDESLOPE +DOWN/-FLAG (GLIDESLOPE COMMON)	P5006	31	Out

The deviation outputs are each capable of driving up to three 1000 Ω meter loads with ± 150 mVdc $\pm 10\%$ with respect to 2.5V Common for full-scale deflection. The drive circuit provides for more than full-scale deflection with a maximum course deviation output voltage of ± 300 mVdc $\pm 10\%$.

4.8.2.3 TO/FROM

Pin Name	Connector	Pin	I/O
VOR/LOC +TO	P5006	1	Out
VOR/LOC +FROM (VOR/LOC COMMON)	P5006	2	Out

The output is capable of driving up to three 200 Ω meter loads. When indicating TO, the output is $+225 \pm 75$ mVdc. When indicating FROM, output is -225 ± 75 mVdc. When invalid information is present (Flag IN VIEW) the TO/FROM output is 0 ± 10 mVdc.

4.8.2.4 Flag

Pin Name	Connector	Pin	I/O
VOR/LOC +FLAG	P5006	3	Out
VOR/LOC -FLAG (VOR/LOC COMMON)	P5006	4	Out
GLIDESLOPE +FLAG	P5006	30	Out
GLIDESLOPE +DOWN/-FLAG (GLIDESLOPE COMMON)	P5006	31	Out

The Flag output is capable of driving up to three 1000 Ω meter loads. When valid information is present (Flag OUT OF VIEW) the Flag output is 375 \pm 80 mVdc. When invalid information is present (Flag IN VIEW) the Flag output is 0 \pm 25 mVdc.

4.8.2.5 OBS

Pin Name	Connector	Pin	I/O
VOR OBS ROTOR C	P5006	9	Out
VOR OBS ROTOR H (GROUND)	P5006	10	Out
VOR OBS STATOR D	P5006	13	In
VOR OBS STATOR F	P5006	12	In
VOR OBS STATOR E/G (VOR/LOC COMMON)	P5006	11	Out

VOR OBS ROTOR C and H are a buffered 500 Hz output that is intended to drive the OBS rotors. VOR OBS STATOR D and VOR OBS STATOR F are each phase and amplitude shifted version of the VOR ROTOR C output. Each pair is intended to read one of the two windings of the indicator's OBS stator.

4.8.2.6 VOR/LOC COMPOSITE

Pin Name	Connector	Pin	I/O
VOR/LOC COMPOSITE OUT	P5006	8	Out

With a Standard VOR Test Signal applied, VOR/LOC COMPOSITE OUT is 0.5 \pm 0.1 V_{RMS} into a 10 k Ω load. With a Standard Localizer Centering Test Signal applied, VOR/LOC COMPOSITE OUT is 0.350 \pm 0.05 V_{rms} into a 10 k Ω load.

4.8.2.7 ILS ENERGIZE

Pin Name	Connector	Pin	I/O
ILS ENERGIZE	P5006	29	Out

The driver output voltage is not more than 1.0 V when sinking 20 mA. The maximum off state leakage current with respect to GND is less than 10 μ A.

4.8.3 VOR/ILS Indicator Configuration

Refer to section 5.2.12 for the VOR/LOC/GS configuration.

4.8.4 VOR/ILS Indicator Calibration and Checkout

Refer to sections 5.2.12 and 5.3.8 for the VOR/LOC/GS checkout.

4.8.5 VOR/ILS Indicator Interconnect

Refer to Figure F-27 on page F-55 for the VOR/ILS indicator interconnect.

4.9 RMI/OBI

4.9.1 RMI/OBI Function

The MAIN OBI output provides bearing information from the active waypoint for Bendix/King Serial OBI devices based upon the 500 Series unit's GPS navigation. For the GNS 530, the MAIN OBI output may be configured so that it sends VOR/ILS bearing information when VLOC is selected by the GNS 530 CDI key.

The VOR OBI output provides bearing information from the active waypoint for Bendix/King Serial OBI devices based upon the GNS 530 VOR receiver.

When a localizer channel is tuned on the VLOC window, there is a bit in the data stream set to indicate that a localizer frequency is tuned which stows the needle or drive it to the 3 o'clock position.

4.9.2 RMI/OBI Electrical Characteristics

Pin Name	Connector	Pin	I/O
MAIN OBI CLOCK	P5001	43	Out
MAIN OBI SYNC	P5001	45	Out
MAIN OBI DATA	P5001	44	Out

Pin Name	Connector	Pin	I/O
VOR OBI CLOCK	P5006	25	Out
VOR OBI SYNC	P5006	26	Out
VOR OBI DATA	P5006	27	Out

The output driver is active low. The driver output voltage is not more than 1.0 V when sinking 20 mAdc. The maximum off state leakage current with respect to ground is less than 10 μ Adc.

4.9.3 RMI/OBI Configuration

For the GNS 530, refer to section 5.2.9 for the MAIN OBI source configuration.

4.9.4 RMI/OBI Calibration and Checkout

None.

4.9.5 RMI/OBI Interconnect

Refer to Figure F-28 on page F-57 for the RMI/OBI interconnect.

4.10 DME TUNING (GNS 530 ONLY)

4.10.1 DME Tuning Function

The GNS 530 can channel a DME based on the tuned VLOC frequency. The GNS 530 outputs 2 of 5, BCD or Slip parallel DME and King Serial DME channeling format. When DME COMMON is held low, the GNS 530 actively tunes the DME.

4.10.2 DME Tuning Electrical Characteristics

4.10.2.1 Parallel DME Tuning

Pin Name	Connector	Pin	I/O
NAV PAR DME - 8MHZ	P5006	14	Out
SER DME – CHAN REQ/PAR DME - 4MHZ	P5006	20	Out*
SER DME – RNAV MODE/PAR DME – 2MHZ	P5006	21	Out*
NAV PAR DME - 1MHZ	P5006	33	Out
NAV PAR DME - 800KHZ	P5006	37	Out
NAV PAR DME - 400KHZ	P5006	39	Out
NAV PAR DME - 200KHZ	P5006	40	Out
NAV PAR DME - 100KHZ	P5006	42	Out
NAV PAR DME - 50KHZ	P5006	43	Out
NAV DME COMMON	P5006	22	In

* These pins are outputs when the GNS 530 is configured for 2 of 5 parallel DME tuning.

For each of the parallel DME tuning discrete outputs, the driver output voltage is not more than 1.0 V while sinking 20 mA. The maximum off state leakage current with respect to ground is less than 10 μ A.

NAV DME COMMON must be pulled low to indicate to the NAV module that it is the device channeling the DME.

NAV DME COMMON is considered active if either the voltage to ground is <1.9 V or the resistance to ground is <375 Ω . These inputs are considered inactive if the voltage to ground is 11-33 Vdc.

4.10.2.2 King Serial DME Tuning

Pin Name	Connector	Pin	I/O
NAV SER DME – DATA	P5006	19	Out
NAV SER DME – CLOCK	P5006	18	Out
SER DME – CHAN REQ/PAR DME - 4MHZ	P5006	20	In*
SER DME – RNAV MODE/PAR DME – 2MHZ	P5006	21	In*
NAV DME COMMON	P5006	22	In

* These pins are inputs when the GNS 530 is configured for King Serial DME tuning

When NAV SER DME – DATA or NAV SER DME – CLOCK is asserted high and driving a 360 Ω load, the driver output voltage is not less than 8 V, and when asserted low shall not be greater than 10 mV.

SER DME – CHAN REQ/PAR DME – 4MHZ, SER DME – RNAV MODE/PAR DME – 2MHZ, and NAV DME COMMON are considered active if either the voltage to ground is <1.9 V or the resistance to ground is <375 Ω . These inputs are considered inactive if the voltage to ground is 11-33 Vdc.

NAV DME COMMON must be pulled low to indicate to the NAV module that it is the device channeling the DME.

4.10.3 DME Tuning Configuration

Refer to section 5.2.12 for the DME tuning configuration.

4.10.4 DME Tuning Calibration and Checkout

None.

4.10.5 DME Tuning Interconnect

Refer to Figure F-29 on page F-59 for the King Serial Panel DME tuning interconnect. Refer to Figure F-30 on page F-61 for the King Serial Remote DME tuning interconnect. Refer to Figure F-31 on page F-63 for the parallel 2 of 5 DME tuning interconnect. Refer to Figure F-32 on page F-65 for the parallel BCD/Slip Code DME tuning interconnect.

NOTE

For the GNS 530 to tune a Narco DME 890 or IDME 891 or an ARC (Cessna) RTA-576A using parallel 2 of 5, unique wiring and configuration are required. Refer to section 5.2.12 on page 5-13 and Figure F-31 on page F-63.

4.11 TERRAIN AWARENESS WARNING SYSTEM (TAWS)

4.11.1 Audio

Pin Name	Connector	Pin	I/O
TAWS AUDIO HI	P5001	52	Out
TAWS AUDIO LO	P5001	53	--

The TAWS audio output will be 100 mW across a 500 ohm load. TERRAIN AUDIO HI outputs voice audio.

4.11.2 Annunciators

Pin Name	Connector	Pin	I/O
TERRAIN NOT AVAILABLE ANNUNCIATE	P5050	9	Out
TERRAIN WARNING ANNUNCIATE	P5050	10	Out
TERRAIN CAUTION ANNUNCIATE	P5050	11	Out
TAWS INHIBIT ANNUNCIATE	P5050	12	Out

TERRAIN NOT AVAILABLE ANNUNCIATE sinks up to 500 mA when not active. All other annunciator outputs sink 500 mA when active.

4.11.3 RS-232

Pin Name	Connector	Pin	I/O
RS232_OUT_5	P5050	60	Out
RS232_IN_5	P5050	61	In

The RS-232 outputs conform to EIA Standard RS-232C with an output voltage swing of at least ± 5 V when driving a standard RS-232 load.

4.11.4 Misc

Pin Name	Connector	Pin	I/O
TAWS INHIBIT OUT	P5050	1	Out
TAWS AUDIO INHIBIT IN	P5050	2	In
TAWS AUDIO ACTIVE OUT	P5050	15	Out

The TAWS AUDIO INHIBIT OUT and TAWS AUDIO INHIBIT INPUT are active low.

NOTE

TAWS functions can also be inhibited via the GPS 500/GNS 530.

TAWS AUDIO INHIBIT IN is used to inhibit TAWS audio. This can be connected to inhibit output lines of another unit whose audio is higher in priority.

TAWS AUDIO ACTIVE OUT allows the TAWS system to announce that it is playing audio. This can be connected to the audio inhibit in lines of other units whose audio is of less priority than TAWS.

4.11.5 TAWS Configuration

Refer to section 5.2.21 & 5.2.22 for the TAWS configuration.

4.11.6 TAWS Calibration and Checkout

Refer to section 5.3.10 for the TAWS checkout.

5. POST INSTALLATION CONFIGURATION & CHECKOUT PROCEDURE

5.1 CONFIGURATION MODE OPERATIONS

With power applied to the aviation rack and the 500 Series unit turned off, press and hold the ENT key and turn the unit on. Release the ENT key when the display activates. After the Data Base and Instrument Panel Self-test pages, the first page displayed is the MAIN ARINC 429 CONFIG page. While in Configuration Mode, pages can be selected by ensuring the cursor is off and rotating the small right knob.

To change data on the displayed Configuration Page, press the small right knob (CRSR) to turn on the cursor. Turn the large right knob to change between data fields. Turn the large or small right knob to change a field that the cursor is on. Once you have made the desired selection, press the ENT key to accept the entry.

5.2 INSTALLATION CONFIGURATION PAGES

The Configuration Pages described in the following sections are in the order found when rotating the right small knob clockwise starting at the MAIN ARINC 429 CONFIG page. Use the procedure described in section 5.1 to get to this page.

NOTE

The configuration pages shown here reflect Main Software version 5.00. All configuration pages shown apply to the GNS 530, but not all apply to the GPS 500. Those pages and fields that apply only to certain 500 Series units are denoted as such.

5.2.1 MAIN ARINC 429 CONFIG Page

Select the MAIN ARINC 429 CONFIG Page (see Figure 5-1). This page configures the GPS ARINC 429 output port and the two GPS ARINC 429 input ports. The two input ports can each be configured independently for the desired function(s).



Figure 5-1.
MAIN ARINC 429 CONFIG Page

SPEED

Selection	Description
Low	Standard low-speed ARINC 429 (nominally 12.5 kilobits per second)
High	High-speed ARINC 429 (nominally 100 kilobits per second)

DATA IN 1, DATA IN 2

Selection	Description
Off	No unit connected to this ARINC 429 input
Airdata	Altitude, temperature, and speed information from the following Airdata systems: <i>B & D 2600, 2601, 2800, 90004-003</i> <i>Bendix/King KAD 280/480, Shadin ADC 2000</i>
Airdata/AHRS	Heading, altitude, temperature, and speed information from an Airdata/AHRS system.
Traffic Advisory	Traffic information from the following traffic advisory systems: <i>BF Goodrich SKY497 Skywatch/Skywatch HP</i> <i>Bendix/King KTA-870, KMH880</i>
BFG SkyWatch	Traffic information from a BF Goodrich SKY497 Skywatch system.
EFIS	Selected course, heading, and joystick waypoint information from the following EFIS systems: <i>Bendix/King EFS 40/50</i> Certain versions of Collins EFIS may also be compatible with this format.

DATA IN 1, DATA IN 2, cont.

EFIS/Airdata	Selected course, heading, joystick waypoint, altitude, temperature, and speed information from the following systems: <i>Collins Pro Line 21</i>
Flight control	Selected course information from the following Flight Control systems: <i>Bendix/King KFC 400</i>
Garmin GTX 330	Garmin and Garmin w/TIS This is a Garmin data concentration format. Only high speed ARINC 429 should be used. <i>Garmin GTX 330</i>
Garmin GAD 42	Selected course, heading, and true airspeed data from the Garmin GAD 42.
Honeywell EFIS	Selected course, heading, and joystick waypoint information from the following EFIS systems: <i>Honeywell Primus 1000</i>
INS/IRU	Heading information from the following Inertial systems: <i>Bendix/King KAH 460</i> <i>Collins AHC 85</i> <i>Honeywell Laseref</i> <i>Litef LTR 81</i> <i>Litton LTN 90-100, LTN 91, LTN 92</i>
Radar graphics	Joystick waypoint information from a RADAR graphics unit.
Sandel EHSI	Selected course and heading information from the following EHSI system: <i>Sandel SN3308</i>

DATA OUT

Selection	Description
Off	No unit(s) connected to ARINC 429 output
ARINC 429	Standard ARINC 429 output data (non-GAMA).
GAMA 429	ARINC 429 data as defined by the <i>General Aviation Manufacturers' Association (GAMA) General Aviation Subset, 2nd Edition</i> . The output data includes navigation and flight plan information to the following systems: <i>Garmin GAD 42 Interface Adapter</i> <i>Bendix/King EFS 40/50</i> <i>Sandel SN3308</i> <i>Collins EFIS 84</i> <i>Garmin GTX 330</i> Certain other versions of Collins EFIS may also be compatible with this format.
GAMA 429 Graphics	ARINC 429 data as defined by the <i>GAMA General Aviation Subset, 2nd Edition</i> including GAMA Graphics Protocol 'A'. This format outputs intersection symbols as generic waypoint symbols. The output data includes navigation and flight plan information (including graphical representation of flight plan procedures) to the following EFIS systems: <i>Honeywell Primus 1000</i>
GAMA 429 Graphics w/Int	ARINC 429 data as defined by the <i>GAMA General Aviation Subset, 2nd Edition</i> including GAMA Graphics Protocol 'A'. The output data includes navigation and flight plan information (including graphical representation of flight plan procedures).
GAMA 429 Pro Line 21	ARINC 429 data as defined by the <i>GAMA General Aviation Subset, 2nd Edition</i> . The output data includes navigation and flight plan information to the following EFIS systems: <i>Collins Pro Line 21</i>
GAMA 429 Sextant	ARINC 429 data as defined by the <i>GAMA General Aviation Subset, 2nd Edition</i> . The output data includes navigation and flight plan information to the following EFIS systems: <i>Sextant SMD 45</i>

SDI

Selection	Description
Common	Common long-range navigator (only 429 data with SDI=0 is used)
LNAV 1	Number 1 (Pilot) long-range navigator. Only 429 data with SDI=0 or SDI=1 is used.
LNAV 2	Number 2 (Copilot) long-range navigator. Only 429 data with SDI=0 or SDI=2 is used.

5.2.2 MAIN RS-232 CONFIG Page

Select the MAIN RS-232 CONFIG Page (see Figure 5-2). If necessary, change the selectable RS-232 inputs and/or outputs to match that of the equipment installed in the aircraft.

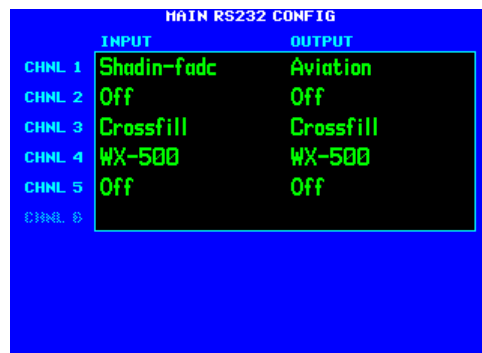

Figure 5-2. MAIN RS-232 CONFIG Page

CHANNEL INPUTS

Selection	Description
Off	No unit(s) connected to input of this channel.
Arnav/ei-fuel	Serial fuel flow information from the following units: <i>ARNAV FC-10, FT-10</i> <i>Electronics International FP-5L</i>
Crossfill	Serial transfer of flight plans and user waypoints between two 500 Series units
GDL 49	Serial data input for in-flight access to weather and messaging
Icarus-alt	Serial altitude data from the following units: <i>Icarus Instruments 3000, Sandia SAE5-35</i> <i>Garmin GTX 327 Transponder</i>
Ryan TCAD	Traffic information from a Ryan TCAD 9900B Series system.
Shadin-adc	Serial air data information from the following units: <i>Shadin ADC 200, 200+, 2000</i>
Shadin-alt	Serial altitude data from the following units: <i>Shadin 8800T, 9000T, 9200T</i>
Shadin-fadc	Serial air data and fuel flow information from the following units: <i>Shadin 9628XX-X Fuel/Air Data Computer</i>
Shadin-fuel	Serial fuel flow information from the following units: <i>Shadin 91204XM Digital Fuel Management System</i> <i>Shadin 91053XM Digital Fuel Management System</i> <i>JP Instruments EDM-700 or EDM-760 Engine Monitor</i>
WX-500	Lightning strike information from a BF Goodrich WX-500 Stormscope.

CHANNEL OUTPUTS

Selection	Description
Off	No unit(s) connected to output of this channel.
Aviation	Serial position, altitude, velocity, and navigation data to the following units: <i>Garmin GPSMAP 295, GPSMAP 195 or GPS III Pilot</i> <i>Argus 3000, 5000, or 7000 Moving Map</i> <i>Electronics International FP-5L Fuel Flow Computer (non-TSO'd)</i> <i>JP Instruments EDM-700 or EDM-760 Engine Monitor</i> <i>Shadin 91204XM Digital Fuel Management System</i> <i>Shadin 91053XM Digital Fuel Management System</i> <i>Shadin 9628XX-X Fuel/Air Data Computer</i> <i>Stormscope Series II (with Navaid) Moving Map</i> <i>Garmin GTX 327 Transponder</i>
Avtn no alt	Serial position, velocity, and navigation data to the following units: <i>Horizon DDMP</i>
Crossfill	Serial transfer of flight plans and user waypoints between two 500 Series units
HW EGPWS	Serial communication to a Bendix/King (Honeywell) KGP 560 EGPWS.
Ryan TCAD	Serial communication with a Ryan TCAD 9900B Series system.
WX-500	Serial communication to a BF Goodrich WX-500 Stormscope.
GDL 49	Serial communication to a Garmin GDL 49

5.2.3 MAIN SYSTEM CONFIG

Select the MAIN SYSTEM CONFIG Page (see Figure 5-3). This page allows you to configure the Fuel and Terrain options.

Fuel

Select **Fuel** in the **CONFIGURE** field to select the FUEL TYPE (AV Gas, Jet A, or Jet B)

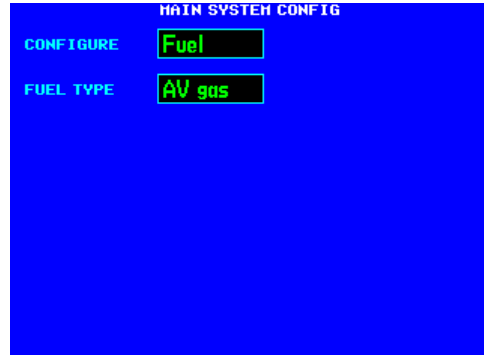

Figure 5-3. MAIN SYSTEM CONFIG Page

Selection	Description
AV gas	The aircraft is using Aviation gas (5.8 lbs./gal.)
Jet A	The aircraft is using Jet A or Jet A-1 fuel (6.7 lbs./gal.)
Jet B	The aircraft is using Jet B (JP-4) fuel (6.5 lbs./gal.)

Terrain

Select **Terrain** in the **CONFIGURE** field to select the TERRAIN TYPE (**NONE**, **TERRAIN**, or **TAWS**).

To test the Terrain Data Card, highlight the **TEST CARD** field and press the ENT key. Verify that the **TEST CARD** field indicates “PASS”. A “FAIL” condition indicates that the Terrain Data Card is unusable

Note that if “TAWS” will not appear in the **HW CONFIG** field, there is a hardware conflict with the TAWS boards.

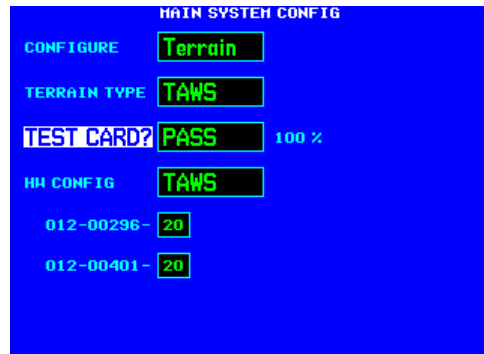

Figure 5-4. MAIN SYSTEM CONFIG Page

Selection	Description
None	No terrain functionality (TERRAIN or TAWS) is installed.
TERRAIN	The unit is configured for TERRAIN capability.
TAWS	The unit is configured for TAWS capability.

Note that the software will detect a hardware upgrade and self-upgrade itself to the appropriate terrain type. The software will automatically upgrade from **None** ➔ **TERRAIN** ➔ **TAWS**. However, the software will not downgrade a higher level setting and will issue a terrain configuration conflict message should this situation arise.

5.2.4 MAIN INPUTS Page

Select the MAIN INPUTS Page (see Figure 5-5). This page allows you to monitor the data on ARINC 429, RS-232 and other electrical inputs. This is used for verifying electrical interfaces during installation and troubleshooting. Information that is not being received by the 500 Series unit is dashed out.

Field	Description
OAT	Outside Air Temperature
SAT	Static Air Temperature
TAT	Total Air Temperature
IAS	Indicated Airspeed
TAS	True Airspeed
W SPD	Wind Speed
HDG	True Heading
W DIR	Wind Direction
GPS SC	GPS Selected Course
VLC SC	VOR/LOC Selected Course (GNS 530 Only)
CDI	Status of the CDI key (GNS 530 Only).
B ALT	Barometric-corrected Altitude
D ALT	Density Altitude
P ALT	Pressure Altitude
L FF	Left Engine Fuel Flow
R FF	Right Engine Fuel Flow
T FF	Total Fuel Flow
T FOB	Total Fuel on Board
JOYSTICK WPT	Latitude and longitude of a joystick waypoint sent by an EFIS or RADAR indicator.



Figure 5-5. MAIN INPUTS Page

5.2.5 INSTRUMENT PANEL SELF-TEST Page

Select the INSTRUMENT PANEL SELF-TEST Page (see Figure 5-6). This page allows verification that the 500 Series unit is communicating properly with other instruments. Compare on-screen indications with the information depicted on connected instruments, such as the CDI, HSI, RMI and/or external annunciators. It also displays fuel capacity, amount on-board, and flow.

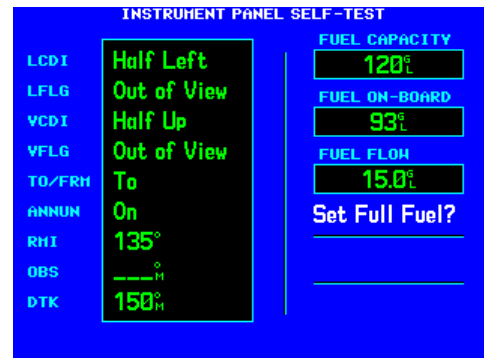

Figure 5-6. INSTRUMENT PANEL SELF-TEST Page

5.2.6 MAIN LIGHTING Page

Select the MAIN LIGHTING Page (see Figure 5-7). This page allows you to set display parameters that affect the display backlight and key lighting brightness. The DISPLAY and KEY lighting characteristics are adjusted separately, each with the following fields:

LIGHTING

Shows the current level of display backlighting, based on the lighting input source (lighting bus voltage, or the ambient light if the source is PHOTO) and the settings on this configuration page. This field has a range of 0 (zero) to 9999.



Figure 5-7. MAIN LIGHTING PAGE

SOURCE

Selection	Description
PHOTO	Backlight level is determined by the ambient light level as measured by the photocell on the 500 Series unit.
14V DC	Backlight level tracks a 14 volt DC aircraft lighting bus.
28V DC	Backlight level tracks a 28 volt DC aircraft lighting bus.
5V DC	Backlight level tracks a 5 volt DC aircraft lighting bus.
5V AC	Backlight level tracks a 5 volt AC aircraft lighting bus.

NOTE

If a lighting bus (any selection other than **PHOTO**) is selected, and the lighting bus control is turned to its minimum (daytime) setting, the display brightness tracks the 500 Series unit's photocell using additional parameters (PHOTO TRANS % and PHOTO SLP/OFFST) described below.

RESP TIME - (Response Time)

Sets the speed with which the brightness responds to the input level (bus voltage or ambient light) changes. The higher the number the slower the display responds. This field has a range of 3 to 7, and is set to 4 at the factory.

MIN - (Minimum)

Sets the minimum brightness of the display. The higher the number, the brighter the minimum brightness. Display minimum brightness has a range of 35 to 999, and is set to 80 at the factory. Key minimum brightness has a range of 20 to 99, and is set to 40 at the factory. It is prudent to verify that display and key lighting characteristics match those of other equipment in the panel under night lighting conditions.

SLOPE

Sets the sensitivity the brightness of the display has to changes in the input level. The higher the number, the brighter the display for a given increase in the input level. This field has a range of 0 (zero) to 99, and is set to 50 at the factory.

OFFSET

Adjusts the lighting level up or down for any given input level. This field has a range of 0 (zero) to 99, and is set to 50 at the factory. This may also be used to match lighting curves with other equipment in the panel.

PHOTO TRANS % - (Photocell Transition Percentage)

When a lighting bus is used to control the lighting of the display (see Figure 5-8), this parameter sets the point on the lighting bus control below which the display brightness tracks the 500 Series unit's photocell. This field has a range of 0 (zero) to 99, and is set to 25 at the factory.

PHOTO SLP/OFFST - (Photocell Slope/Offset)

These fields are equivalent to the **SLOPE/OFFSET** fields described above, with the exception that they only control the display lighting characteristics when the lighting bus control is below the level specified in the **PHOTO TRANS %** field. Both fields have a range of 0 (zero) to 99, and are set to 50 at the factory.

5.2.7 DATE/TIME SETUP Page

Select the DATE/TIME SETUP Page (see Figure 5-9). Very infrequently, it may be desirable to set the date and time of the 500 Series unit to aid in acquiring a GPS position. Configuration mode is the only means by which the date and time for the 500 Series unit may be adjusted. Note that the time must be UTC time, and that the UTC date may be different from the date in the local time zone.



**Figure 5-8. MAIN LIGHTING Page
(Display Lighting from Lighting Bus)**

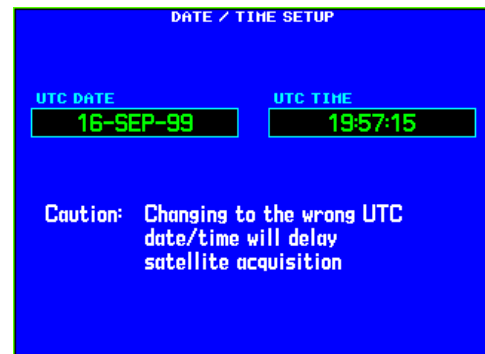

**Figure 5-9.
DATE/TIME SETUP Page**

5.2.8 MAIN DISCRETE I/O Page

Select the MAIN DISCRETE I/O Page (see Figure 5-10).

GRAY CODE

If the encoding altimeter input is used, verify that the **DECODED ALTITUDE** field indicates the correct altitude.



Figure 5-10.
MAIN DISCRETE I/O Page

Selection	Verify That:
RMT CDI	The box is filled in while a remote CDI source select switch is pressed.
RMT OBS	The box is filled in while a remote OBS switch is pressed.
TER INHB	The box is filled in while a remote TERRAIN INHIBT switch is pressed.

DISCRETE TOGGLE

This allows you to verify the operation of any external annunciators that are present in the installation.

Selection	Verify That:
APR	The APR annunciator is active and inactive as selected on this page.
GPS	The GPS source select annunciator is active and inactive as selected on this page.
INTEG	The INTEG annunciator is active and inactive as selected on this page.
MSG	The MSG annunciator is active and inactive as selected on this page.
OBS	The OBS annunciator is active and inactive as selected on this page.
TERM	The TERM annunciator is active and inactive as selected on this page.
VLOC	The VLOC source select annunciator is active and inactive as selected on this page.
WPT	The WPT annunciator is active and inactive as selected on this page.
ILS/GPS APR	The ILS/GPS APPROACH output is active and inactive as selected on this page (NOTE: This output is connected to the autopilot ILS ENGAGE input, not to an annunciation, and therefore this is for bench testing purposes only).
TER CAUT	The TER CAUT annunciator is active and inactive as selected on this page.
TER INHB	The TER INHB annunciator is active and inactive as selected on this page.
TER N/A	The TER N/A annunciator is active and inactive as selected on this page.
TER TEST	The TER TEST annunciator is active and inactive as selected on this page.
TER WARN	The TER WARN annunciator is active and inactive as selected on this page.

5.2.9 MAIN CDI/OBS CONFIG Page

Select the MAIN CDI/OBS CONFIG Page (see Figure 5-11). This page allows you to verify the MAIN CDI outputs, both lateral (LAT) and vertical (VERT), and verify and calibrate the MAIN OBS input. Using the controls on the 500 Series unit front panel, make the selections below and verify the interfaces as appropriate:

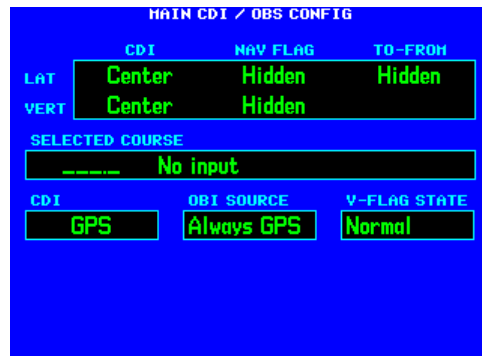

Figure 5-11.
MAIN CDI/OBS CONFIG Page

CDI (LAT/VERT)

Selection	Verify That:
Max left/up	The CDI is “pegged” to the left/up.
Full left/up	The CDI is deflected full scale to the left/up.
Center	The CDI is centered.
Full right/down	The CDI is deflected full scale to the right/down.
Max right/down	The CDI is “pegged” to the right/down.

NAV FLAG (LAT/VERT)

Selection	Verify That:
Hidden	The LAT/VERT flag is hidden.
In view	The LAT/VERT flag is in view.

TO-FROM

Selection	Verify That:
FROM	The FROM flag is in view.
Hidden	The TO/FROM flag is hidden.
TO	The TO flag is in view.

SELECTED COURSE

Select 150° on the CDI/HSI that is connected to the 500 Series unit’s MAIN OBS inputs. The **SELECTED COURSE** field should indicate near to 150° and a **Calibrate to 150°?** field appears. Selecting this field calibrates the 500 Series unit to match the input source. Verify OBS operation by checking that the course displayed on the 500 Series unit is within 2° of the selected course. Do this at 30° intervals around the OBS card.

NOTE

If it is desired to ignore a selected course input (either analog resolver or ARINC 429) for GPS operation in OBS mode, press MENU on the MAIN CDI/OBS CONFIG page and select “Ignore SEL CRS or GPS?”. When OBS mode is selected, the selected course is entered on the controls of the 500 Series unit. If ignoring the selected course input such that the VOR valid flag is dependent only on a valid VOR signal, with lateral deviation calculated by another display device, press MENU on the MAIN CDI/OBS CONFIG page and select “Ignore SEL CRS for VLOC?”.

CDI (GNS 530 Only)

Selection	Description
GPS	The GNS 530 CDI button is in the GPS state, and the GPS ANNUNCIATE output is active. This annunciator output may be required to be active for some installations.
VLOC	The GNS 530 CDI button is in the VLOC state, and the VLOC ANNUNCIATE output is active.
GPS Only	The GNS 530 CDI button has been disabled.

NOTE

If it is desired to disable the GNS 530 CDI key, press MENU on the MAIN CDI/OBS CONFIG page and select "Ignore CDI key?". This causes the field above the CDI key to always display GPS, regardless of CDI key presses. This may be necessary for certain EFIS systems where navigation sensor selection must be accomplished on the EFIS or its control panel.

OBI SOURCE (GNS 530 Only)

Selection	Description
Always GPS	The MAIN King Serial OBI outputs are always GPS. This is useful if it is desired to switch a Bendix/King KI 229 or KNI 582 RMI pointer independently from the GNS 530 CDI button.
Track CDI	The MAIN King Serial OBI outputs are GPS or VOR, and switchable by the GNS 530 CDI button. This is useful if it is desired the Bendix/King KI 229 or KNI 582 RMI pointer to display the same navigation source as the GNS 530 CDI outputs.

VERT CDI

Selection	Description
Flag Up	The vertical deviation bar is parked in the full-scale up position when GPS or VOR navigation is selected for output. The exception is when the CDI is in VLOC mode and an ILS frequency is tuned, in which case the vertical deviation bar is parked in the centered position.
Flag Center	The vertical deviation bar is parked in the centered position whenever it is flagged.

5.2.10 COM SETUP Page (GNS 530 Only)

Select the COM SETUP Page (see Figure 5-12). These values are set at the factory and seldom require calibration.

FREQ

Selects a VHF communication frequency. For purposes of setting the squelch and sidetone levels, only the frequencies 118.000, 127.000, and 136.975 MHz can be used.



Figure 5-12. COM SETUP Page

SPACING

Selection	Description
25.0 kHz	Selects traditional 25 kilohertz spacing (760 channel).
8.33 kHz	Selects 8.33 kilohertz channel spacing, which is required in some areas of the world.

CAUTION

8.33 kHz channels are not authorized for use in the United States.

SQ 250

Sets the squelch threshold for 25 kHz channel spacing operation. May be set to any value between 0 (zero) and 63. The higher the number, the less signal is required to break squelch.

NOTE

For GNS 530 units with serial number 200 or lower, the operation of the SQ 250 setting is reversed. The higher the SQ 250 number, the more signal is required to break squelch.

SQ 833

Sets the squelch threshold for 8.33 kHz channel spacing operation. May be set to any value between 0 (zero) and 63. The higher the number, the more signal is required to break squelch.

SIDETN

Sets the sidetone audio output level. May be set to any value between 0 (zero) and 63.

NOTE

The sidetone audio output level is independent of the COM volume knob on the 500 Series unit.

Store Calibration?

Select this field and press the ENT key to accept the squelch threshold and sidetone audio settings on this page. If you wish for the squelch and sidetone settings to return to their previous values, *do not* select this field. Simply change to the next configuration page, or turn off the unit if you are done with configuration.

Selection	Verify That:
PTT	The box is filled in while the COM push-to-talk switch is pressed.
XFR	The box is filled in while a remote COM transfer switch is pressed.
RX	The box is filled in while the COM is receiving a signal.
TX	The box is filled in while the COM push-to-talk switch is pressed.

5.2.11 VOR DISCRETE INPUTS Page (GNS 530 Only)

Select the VOR DISCRETE INPUTS Page (see Figure 5-13). This page allows you to verify the operation of an external VLOC transfer switch that may be present in the installation.



Figure 5-13.
VOR DISCRETE INPUTS Page

Selection	Verify That:
REMOTE XFR	The box is filled in while a remote VLOC transfer switch is pressed.

5.2.12 VOR/LOC/GS CDI Page (GNS 530 Only)

Select the VOR/LOC/GS CDI Page (see Figure 5-14). This page allows you to verify and calibrate the CDI outputs, both lateral (LAT) and vertical (VERT) from the VOR/LOC/Glideslope receiver, as well as the OBS resolver input to the VOR receiver. It also allows you to select the format for DME tuning data. Using the controls on the GNS 530 front panel, make the selections below and verify the interfaces as appropriate:

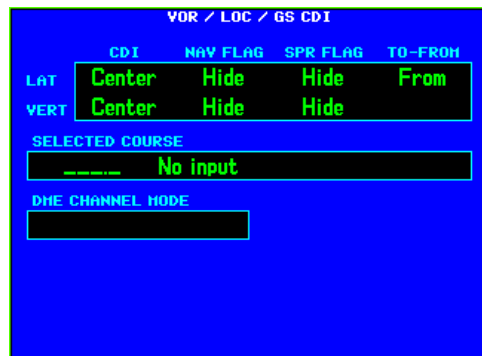

Figure 5-14.
VOR/LOC/GS CDI Page

NOTE

The LAT, VERT, and SELECTED COURSE configurations only apply to installations where a CDI/HSI is connected to the VOR/LOC/GLIDESLOPE pins on connector P5006.

CDI (LAT/VERT)

Selection	Verify That:
Max left/up	The CDI is “pegged” to the left/up.
Full left/up	The CDI is deflected full scale to the left/up.
Center	The CDI is centered.
Full right/down	The CDI is deflected full scale to the right/down.
Max right/down	The CDI is “pegged” to the right/down.

FLAG (LAT/VERT)

Selection	Verify That:
Hide	The LAT/VERT flag is hidden.
View	The LAT/VERT flag is in view.

S-FLG (LAT/VERT)

Selection	Verify That:
Hide	The LAT/VERT superflag is hidden.
View	The LAT/VERT superflag is in view.

TO-FROM

Selection	Verify That:
FROM	The FROM flag is in view.
Hide	The TO/FROM flag is hidden.
TO	The TO flag is in view.

SELECTED COURSE

Select 150° on the CDI/HSI that is connected to the 500 Series VOR/LOC/GS OBS inputs. The **SELECTED COURSE** field should indicate near to 150° and a **Calibrate to 150°?** field appears. Selecting this field calibrates the 500 Series to match the input source. Verify OBS operation by checking that the course displayed on the 500 Series is within 2° of the selected course. Do this at 30° intervals around the OBS card.

DME CHNL MODE

This configuration allows you to set the format for DME tuning data output.

Selection	Description
King Serial	King Serial DME tuning data (not operational for MAIN software versions 2.02 and lower).
Parallel 2x5	2 of 5 parallel DME tuning.
Parallel BCD	Shifted BCD (Binary Coded Decimal) parallel DME tuning (not operational for MAIN software versions 2.02 and lower).
Parallel slip	Slip-code parallel DME tuning (not operational for MAIN software versions 2.02 and lower).
Narco 890/891	2 of 5 parallel DME tuning, compatible with the following DME units: <i>Narco DME 890</i> <i>Narco DME 891</i> <i>ARC (Cessna) RTA-476A</i>

5.2.13 VOR/LOC/GS ARINC 429 CONFIG Page (GNS 530 Only)

Select the VOR/LOC/GS ARINC 429 CONFIG Page (see Figure 5-15). This page configures the VOR/ILS ARINC 429 output and input ports.

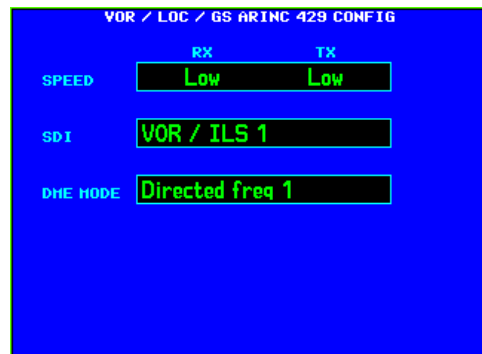

Figure 5-15. VOR/LOC/GS ARINC 429 CONFIG Page

SPEED

Selection	Description
Low	Standard low-speed ARINC 429 (nominally 12.5 kilobits per second)
High	High-speed ARINC 429 (nominally 100 kilobits per second)

SDI

Selection	Description
Common	Common VOR/ILS receiver (only 429 data with SDI=0 is used)
VOR/ILS 1	Number 1 (Pilot) VOR/ILS receiver. Only 429 data with SDI=0 or SDI=1 is used.
VOR/ILS 2	Number 2 (Copilot) VOR/ILS receiver. Only 429 data with SDI=0 or SDI=2 is used.

DME MODE

Selection	Description
Directed freq 1	If the GNS 530 is connected to a multi-channel ARINC 429 DME, channel 1 of that DME is tuned. "Directed freq 1" should be selected if a single-channel ARINC 429 DME is to be tuned.
Directed freq 2	If the GNS 530 is connected to a multi-channel ARINC 429 DME, channel 2 of that DME is tuned.

5.2.14 STORMSCOPE CONFIG Page

(Only if 500 Series unit configured for BFG WX-500 Stormscope interface)

Select the STORMSCOPE CONFIG Page (see Figure 5-16). This page shows the BF Goodrich WX-500 Stormscope configuration as reported by the WX-500 through RS-232 data.

Verify that the **STATUS** field indicates "Ok", and that the other displayed parameters are correct. Verify that all the boxes in the lower portion of the page are green.

When a 500 Series unit is used with a WX-500 Stormscope, the "Synchro" or "Serial" heading formats may be used. If another heading format is used, lightning strike information is visible on the Weather Page, but not the Map Page or Arc Page.

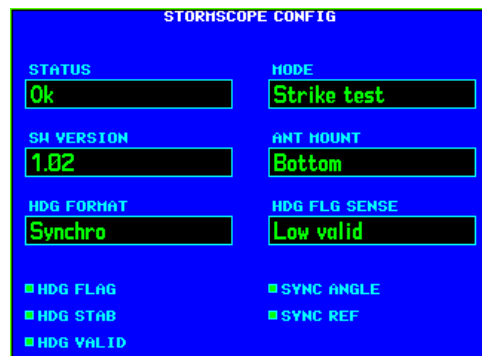

Figure 5-16.
STORMSCOPE CONFIG Page

5.2.15 STORMSCOPE TEST Page

(Only if 500 Series unit configured for BFG WX-500 Stormscope interface)

Select the STORMSCOPE TEST Page (see Figure 5-17). This page shows current strike activity, WX-500 status, and the heading supplied by the WX-500. The WX-500 mode may be changed to 'Demo', 'Noise monitor', 'Self test', 'Strike test', or 'Weather'.

Verify that the WX-500 mode can be changed. Refer to the WX-500 manual for specific installation test procedures for the WX-500, using this page to view strike data, change the WX-500 mode, view WX-500 status, trigger count, and heading.



Figure 5-17.
STORMSCOPE TEST Page

5.2.16 STORMSCOPE DOWNLOAD DATA Page (Only if 500 Series unit configured for BFG WX-500 Stormscope interface)

Select the STORMSCOPE DOWNLOAD DATA Page (see Figure 5-18). This page shows raw data downloadable from the WX-500. Optional sets of data include WX-500 software version, environmental conditions, configuration, and fault data.

Verify that the configuration data is correct as intended. To request which packet of data to display, highlight the data group title and use the small right knob to select the desired group.

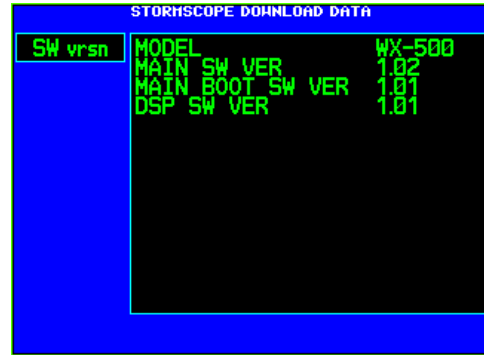

Figure 5-18. STORMSCOPE DOWNLOAD DATA Page

5.2.17 TRAFFIC Page (Only if 500 Series unit configured for BFG Skywatch or Ryan TCAD interfaces)

Select the TRAFFIC Page (see Figure 5-19). This page shows the BFG Skywatch or Ryan TCAD modes of operation and current traffic situation.

For BFG Skywatch, this page shows:

1. The altitude mode—below (BLW), normal (NORM), above (ABV), or unrestricted (UNR)
2. The operating mode—standby (STBY) or operating (OPER)
3. Current altitude (ALT)
4. Altitude limits being imposed (LIM A and LIM B)
5. Heading, and barometric (BARO) and radio (RAD) altitude status.

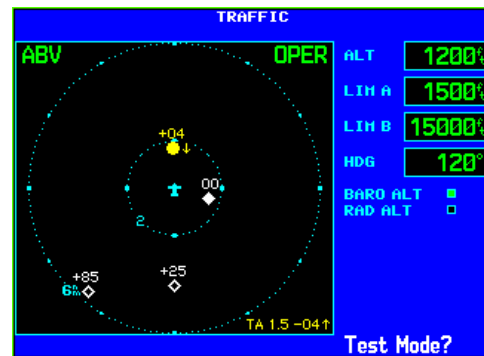

Figure 5-19. TRAFFIC Page (Skywatch)

For BFG Skywatch (see Figure 5-19), verify that the 500 Series unit can change the Skywatch operating mode (STBY or OPER). In standby mode, verify that the Skywatch may be placed in self-test mode by highlighting “Test Mode?” and pressing ENTER on the 500 Series unit. Refer to the BFG Skywatch installation manual for system checkout.

For Ryan TCAD (see Figure 5-20), this page shows the current shield mode and altitude. Verify that the TCAD shield mode may be changed—Ground (GND), Terminal (TML), Standard (STD), En Route (ENR), or Unrestricted (UNR), and that the TCAD is reporting the correct altitude. Refer to the Ryan TCAD installation manual for system checkout.

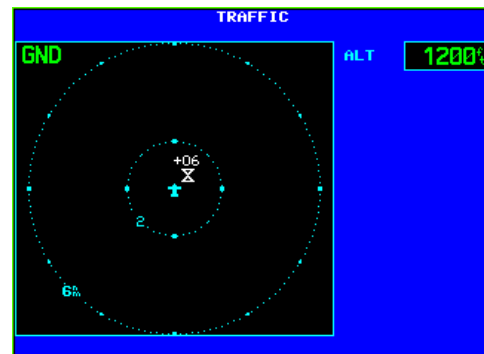

Figure 5-20. TRAFFIC Page (TCAD)

5.2.18 RYAN TCAD CONFIG Page (Only if 500 Series unit configured for Ryan TCAD interface)

Select the RYAN TCAD CONFIG Page (see Figure 5-21). This page shows the TCAD's current shield settings for the selected mode, approach mode status, volume, mute status, mute duration, voice alert selection, and system status.

Verify that the TCAD system status is GREEN. Also, verify that shield settings and volume, mute duration, and voice alert selection can be modified. Verify that changes in mute (if a mute switch is installed) are shown. Refer to the Ryan TCAD installation manual for system checkout.

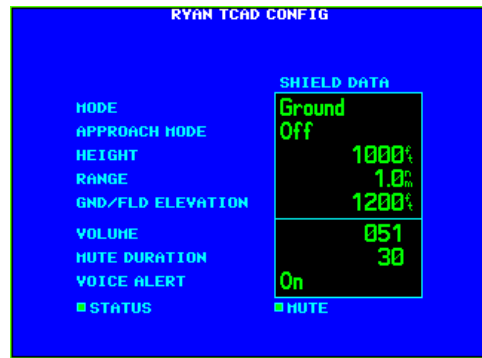

Figure 5-21. RYAN TCAD CONFIG Page

5.2.19 GAD 42 CONFIG Page (Only if 500 Series unit configured for GAD 42 interface)

Select the GAD 42 CONFIG Page (see Figure 5-22). This page allows remote configuration of a GAD 42 Interface Adapter Unit. For details of this function, please refer to Section 5 of the GAD 42 Installation Manual (P/N 190-00159-00).

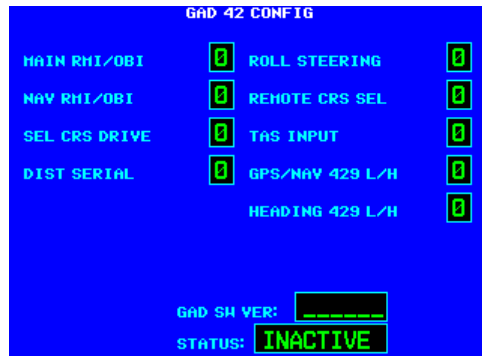

Figure 5-22. GAD 42 CONFIG Page

5.2.20 MONITORING THE DATA LINK

The Data Link is monitored on the Data Link Page. There are four main page groups in the 500 Series software version 2.10 or higher: NAV, WPT, AUX, and NRST (see the 500 Series Pilot's Guide for detailed information on the unit's Page Groups). The Data Link Page (Figure 5-23) appears in the sequence of AUX Pages. For complete installation and configuration information refer to the GDL 49 installation manual, Garmin P/N 190-00231-00.

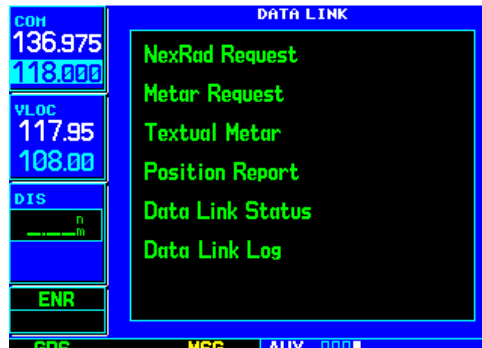

Figure 5-23. Data Link Page

5.2.21 TAWS AUDIO CONFIG Page 1
(Only if TAWS is installed)

Select the TAWS AUDIO CONFIG Page 1 (see Figure 5-24). This page allows configuration of TAWS audio.



Figure 5-24. TAWS AUDIO CONFIG Page 1

5.2.21.1 VOICE Field

Selection	Description
Female	Select the female voice to announce TAWS alerts. (Default)
Male	Select the male voice to announce TAWS alerts.

5.2.21.2 PLAY MSG Field

The **PLAY MSG** field allows the playback of all the individual TAWS alert messages. It does not control the configuration of the messages in any manner.

5.2.21.3 AUDIO Field

Selection	Description
Message	When configured for this option, each TAWS alert message is played by itself. (Default)

5.2.21.4 VOLUME Field

The **VOLUME** field sets the volume of the TAWS alerts from 0% volume (left side) to 100% volume (right side). The default value is 60% of the maximum value. The TAWS volume needs to be set so as to ensure that aural alerts are audible under all anticipated noise environmental conditions. Refer to section 5.3.10 for the TAWS Audio Check procedure.

5.2.21.5 PDA-CAUTION Field

Selection	Description
Too Low - Terrain	Sets the Premature Descent Rate (PDA) cautionary alert to the specified text. (Default)

5.2.21.6 EDR-CAUTION Field

Selection	Description
Sink Rate	Sets the Excessive Descent Rate (EDR) cautionary alert to the specified text. (Default)

5.2.21.7 EDR-WARNING Field

Selection	Description
Pull Up	Sets the Excessive Descent Rate (EDR) warning alert to the specified text. (Default)

5.2.21.8 NCR-CAUTION Field

Selection	Description
Don't Sink	Sets the Negative Climb Rate (NCR) cautionary alert to the specified text. (Default)
Too Low - Terrain	Sets the Negative Climb Rate (NCR) cautionary alert to the specified text. (Default)

5.2.21.9 VCO-CAUTION Field

Selection	Description
Five Hundred	Sets the Voice Callout (VCO) advisory alert to the specified text. (Default)

5.2.22 TAWS AUDIO CONFIG Page 2 (Only if TAWS is installed)

Select the TAWS AUDIO CONFIG Page 2 (see Figure 5-25). This page allows configuration of TAWS audio.

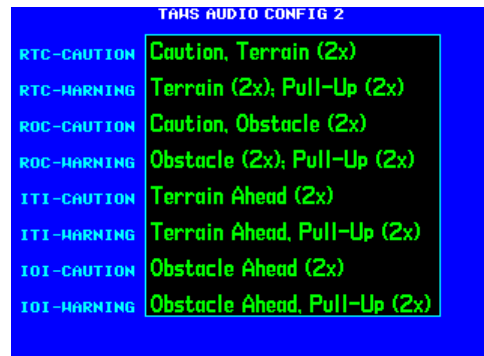

Figure 5-25. TAWS AUDIO CONFIG Page 2

5.2.22.1 RTC-CAUTION Field

Selection	Description
Caution, Terrain (2x)	Sets the Forward Looking Terrain Clearance (FTLA) Reduced Required Terrain Clearance (RTC) cautionary alert to the specified text. (Default)
Terrain Ahead (2x)	Sets the Forward Looking Terrain Clearance (FTLA) Reduced Required Terrain Clearance (RTC) cautionary alert to the specified text.

5.2.22.2 RTC-WARNING Field

Selection	Description
Terrain (2x); Pull-Up (2x)	Sets the Forward Looking Terrain Clearance (FLTA) Reduced Required Terrain Clearance (RTC) warning alert to the specified text. [Default]
Terrain Ahead, Pull-Up (2x)	Sets the Forward Looking Terrain Clearance (FLTA) Reduced Required Terrain Clearance (RTC) warning alert to the specified text.

5.2.22.3 ROC-CAUTION Field

Selection	Description
Caution, Obstacle (2x)	Sets the Forward Looking Terrain Clearance (FLTA) Reduced Required Obstacle Clearance (ROC) cautionary alert to the specified text. [Default]
Obstacle Ahead (2x)	Sets the Forward Looking Terrain Clearance (FLTA) Reduced Required Obstacle Clearance (ROC) cautionary alert to the specified text.

5.2.22.4 ROC-WARNING Field

Selection	Description
Obstacle (2x); Pull-Up (2x)	Sets the Forward Looking Terrain Clearance (FLTA) Reduced Required Obstacle Clearance (ROC) warning alert to the specified text. [Default]
Obstacle Ahead, Pull-Up (2x)	Sets the Forward Looking Terrain Clearance (FLTA) Reduced Required Obstacle Clearance (ROC) warning alert to the specified text.

5.2.22.5 ITI-CAUTION Field

Selection	Description
Caution, Terrain (2x)	Sets the Forward Looking Terrain Clearance (FLTA) Imminent Terrain Impact (ITI) cautionary alert to the specified text.
Terrain Ahead (2x)	Sets the Forward Looking Terrain Clearance (FLTA) Imminent Terrain Impact (ITI) cautionary alert to the specified text. [Default]

5.2.22.6 ITI-WARNING Field

Selection	Description
Terrain (2x); Pull-Up (2x)	Sets the Forward Looking Terrain Clearance (FLTA) Imminent Terrain Impact (ITI) warning alert to the specified text.
Terrain Ahead, Pull-Up (2x)	Sets the Forward Looking Terrain Clearance (FLTA) Imminent Terrain Impact (ITI) warning alert to the specified text. [Default]

5.2.22.7 IOI-CAUTION Field

Selection	Description
Caution, Obstacle (2x)	Sets the Forward Looking Terrain Clearance (FLTA) Imminent Obstacle Impact (IOI) cautionary alert to the specified text.
Obstacle Ahead (2x)	Sets the Forward Looking Terrain Clearance (FLTA) Imminent Obstacle Impact (IOI) cautionary alert to the specified text. [Default]

5.2.22.8 IOI-WARNING Field

Selection	Description
Obstacle (2x); Pull-Up (2x)	Sets the Forward Looking Terrain Clearance (FLTA) Imminent Obstacle Impact (IOI) warning alert to the specified text.
Obstacle Ahead, Pull-Up (2x)	Sets the Forward Looking Terrain Clearance (FLTA) Imminent Obstacle Impact (IOI) warning alert to the specified text. [Default]

5.3 ADDITIONAL GROUND TESTS

5.3.1 Connector Engagement Test

1. Turn on the 500 Series unit, and turn on the avionics master switch (if applicable).
2. Place the 500 Series unit in the rack and engage the pawl mechanism.
3. Turn the Allen screw of the locking pawl slowly clockwise until the 500 Series unit just comes on. A “T” handle makes the turns easy to count, but do not over-tighten.
4. Count the number of complete revolutions you can turn the Allen screw until it can not turn any more (but take care not to over-tighten). Three turns is the minimum for proper installation. If fewer than three turns are possible, the mounting rack should be moved aft such that the aircraft panel does not obstruct the unit from engaging in the rack.

5.3.2 Verification of Self-test Data

Following normal power-up, the Data Base Page is displayed followed by the Instrument Panel Self-Test Page. Pressing the ENT key once then displays the Instrument Panel Self-Test page (refer to Figure 5-4 on page 5-5). During this time, many of the electrical outputs are activated so the installation, configuration, and wiring may be verified. Before approving the Instrument Panel Self-test Page, verify that the following parameters are displayed on equipment in the aircraft as listed below:

NOTE

Electronic displays which monitor the 500 Series unit’s ARINC 429 output may vary in how and where annunciations are displayed. Generally, it is not required to verify every data field with an ARINC 429 interface. Correct display of a subset of the data without noting any discrepancies is typically adequate evidence of correct ARINC 429 operation.

Parameter	Self-test Value
Course Deviation	Half-scale left deviation, TO indication, flag pulled
Glideslope/Vert. Deviation	Half-scale up deviation, flag pulled
Bearing to Waypoint	135°
Desired Track	149.5°
Selected Course	500 Series unit displays the OBS value (149.5° if interfaced to an HSI with driven course pointer).
Distance to Go	10.0 nautical miles
Time to Go	4 minutes
Active Waypoint	“GARMN”
Groundspeed	150 knots
Present Position	N 39°04.05', W 94°53.86'
Waypoint Alert	Active
Phase of Flight	En Route
Message Alert	Active
Leg/OBS Mode	Leg Mode
GPS Integrity	Reflects actual GPS integrity
Roll Steering (if applicable)	Flight Director commands 0° bank (level flight) for 5 seconds; commands increasing right bank at 1°/second for 5 seconds; commands 5° right bank for 5 seconds; commands decreasing right bank at 1°/second for 5 seconds, until command is 0° bank again. This cycle repeats continuously.

5.3.3 Signal Acquisition Test

Upon approval of the Instrument Panel Self-test Page, the Satellite Status Page is displayed. If the unit is unable to acquire satellites, relocate the aircraft away from obstructions which might be shading GPS reception. If the situation does not improve, check the GPS antenna installation.

Once GPS position information is available, use the DIRECT-TO key to activate the navigation function to a nearby airport, NAVAID, or intersection. Ensure that any connected equipment is transmitting and/or receiving data from the 500 Series unit and is functioning properly (see the Pilot's Guide for more information on the direct-to function).

5.3.4 Deviation & Flags Check

5.3.4.1 Analog Deviation & Flags

The analog deviation (LEFT/RIGHT and UP/DOWN), TO/FROM, and FLAG (lateral and vertical) outputs to a CDI or HSI should be verified in flight with potential sources of electrical noise such as autopilot, flaps, gear, heater blowers, etc. operating. Lateral deviation and flags may be checked with either GPS or VOR/ILS, and vertical deviation and flags must be checked with Glideslope. Verify that the flags are hidden at the correct times, and that the flag is in view at the correct times.

5.3.4.2 EHSI Deviation Scaling (Only if HSI/CDI is driven by the 500 Series unit via serial data)

With the 500 Series unit locked onto a GPS fix, activate an OBS waypoint about 20 nautical miles from the present position.

1. With 5.0 nautical mile CDI sensitivity, adjust the OBS course for approximately half-scale deflection on the 500 Series unit's Default Navigation page. Verify that the EHSI displays a similar half-scale deviation.
2. Repeat step 1 with 1.0 nautical mile CDI sensitivity. The CDI sensitivity may be manually set on the AUX SETUP page, using the "CDI / ALARMS" menu item.
3. Repeat step 1 with 0.3 nautical mile CDI sensitivity.

5.3.5 Crossfill Check (Only if dual units installed with RS-232 crossfill connected)

Turn on both 400/500 Series units in the aircraft. For each 400/500 Series unit:

1. Select the first AUX page (titled "FLIGHT PLANNING").
2. Select "CROSSFILL".
3. Verify that the displayed status is "Ready". If "Not Available" is displayed, there may be an RS-232 wiring problem between the two 400/500 Series units.

5.3.6 VHF COM Interference Check

Once the Signal Acquisition Test has been completed successfully, perform the following steps:

1. View the Satellite Status Page and verify that 7 to 8 satellites have been acquired on the 500 Series unit.
2. Verify that the GPS “NAV” flag is out of view.
3. Select 121.150 MHz on the COM transceiver.
4. Transmit for a period of 30 seconds.
5. Verify that the GPS “NAV” flag does not come into view.
6. Repeat steps 4 and 5 for the following frequencies:
 - 25 kHz COM channel spacing**
 - 121.175 MHz
 - 121.200 MHz
 - 131.250 MHz
 - 131.275 MHz
 - 131.300 MHz
 - 8.33 kHz COM channel spacing**
 - 121.190 MHz
 - 130.285 MHz
 - 131.290 MHz
7. Repeat steps 3 through 6 for all COM transceivers installed in the aircraft.
8. If the GPS “NAV” flag comes into view, refer to Section 2.2.7 for options to improve performance.

5.3.7 VHF COM Check (GNS 530 Only)

A flight test is recommended after the installation is complete to ensure satisfactory performance. To check the communications transceiver, maintain an appropriate altitude and contact a ground station facility at a range of at least 50 nautical miles. Contact a ground station in close proximity. Press the squelch disable button to defeat the automatic squelch feature and listen for any unusual electrical noise, which would increase the squelch threshold. If possible, verify the communications capability on both the high and low ends of the VHF COM band. It may be required by the governing regulatory agency to verify operation of the COM transmitter and receiver at the extents of a ground facility’s service volume (e.g., FAA AC 23-8A).

5.3.8 VOR/ILS Check (GNS 530 Only)

Select a VOR channel within a 40 nautical mile range. Listen to the VOR audio and verify that no electrical interference such as magneto noise is present. Check the tone identifier filter operation. Fly inbound or outbound on a selected VOR radial and check for proper LEFT/RIGHT, TO/FROM, and FLAG indications. Check the VOR accuracy. Verify that the flag is hidden with a valid received station, and that the flag is in view when there is not a received station. It may be required by the governing regulatory agency to verify operation of the VOR receiver at the extents of a ground facility’s service volume (e.g., FAA AC 23-8A).

5.3.9 DME Tuning Check (GNS 530 Only)

Select a VOR/ILS channel that corresponds to (1) a DME station within a 40 nautical mile range, or (2) the frequency of a DME ground tester. Verify that the DME locks on to the signal and a valid distance, ground speed and time are displayed.

5.3.10 TAWS Audio Check (For Units With TAWS Only)

While on the ground turn the 500 Series unit on in Configuration Mode. The audio panel should also be turned on for this test.

The TAWS audio volume has an initial default of 60% of the maximum volume value. The TAWS volume needs to be set so as to ensure that aural alerts are audible under all anticipated noise environmental conditions.

1. Select the configuration page labeled 'TAWS AUDIO CONFIG 1'.
2. Go to the **PLAY MSG** field. Rotate the small right knob to play the various TAWS audio messages. There are a total of 24 audio clips. The first audio clip is a 5 second 1 kHz audio tone. The second audio clip is a "beep-beep" annunciation tone. The remaining 22 audio clips are the various TAWS system, caution, and warning messages.
3. Select and play a number of the TAWS audio messages. Adjust the volume so the TAWS messages are audible under all anticipated noise environmental conditions.
 - Evaluate the TAWS audio messages for acceptable volume and intelligibility during both low and high cockpit noise levels (idle descent at low speed and high power at V_{mo}).
 - Adjust the TAWS audio volume by moving the cursor to the **VOLUME** field and rotating small right knob. Turn the knob to the right to increase the volume and to the left to decrease the volume.

5.3.11 TAWS System Check (For Units With TAWS Only)

While on the ground turn the 500 Series unit on following normal power-up procedures. The audio panel should also be turned on.

1. Select the TAWS page.
2. Press the MENU key.
3. Select the **Test Terrain?** field and press the ENT key.
4. Wait until the TAWS self-test completes (10-15 seconds) to hear the TAWS system status aural message.
 - The aural message "TAWS System Test OK" will be annunciated if the TAWS system is functioning properly.
 - The aural message "TAWS System Failure" will be annunciated if the TAWS system is NOT functioning properly.

If no audio message is heard, then a fault exists within the audio system and the TAWS capability must be considered non-functional.

Appendix A. CERTIFICATION DOCUMENTS

A.1 CONTINUED AIRWORTHINESS

This section provides assistance to the installing agency in preparing Instructions for Continued Airworthiness (ICA) in response to Bulletin Number HBAW 98-18, "Checklist for Instructions for Continued Airworthiness for Major Alterations Approved Under the Field Approval Process", effective 10/7/98.

Aviation Authority approved installers are hereby granted permission to reference appropriate service instructions and excerpts from this Installation Manual to accomplish the Instructions for Continued Airworthiness. This permission does not construe suitability of the documents. It is the applicant's responsibility to determine the suitability of the documents for the ICA.

Following is a suggested ICA for a Garmin 500 Series unit installation. Some of the checklist items do not apply, in which case they should be marked "N/A" (Not Applicable). In this sample, square braces are used to indicate instances where explicit words should be substituted (e.g., replace "[500 Series unit]" with "GNS 530").

Instructions for Continued Airworthiness, Garmin [500 Series unit]

1. Introduction

[Aircraft that has been altered: Registration (N-) number, Make, Model and Serial Number]

Content, Scope,

Purpose and Arrangement: This document identifies the Instructions for Continued Airworthiness for the modification of the above aircraft by installation of a Garmin [500 Series unit].

Applicability: Applies to aircraft altered by installation of the Garmin [500 Series unit].

Definitions and Abbreviations: None, N/A.

Precautions: None, N/A.

Units of Measurement: None, N/A.

Referenced Publications: Garmin 500 Series Installation Manual, P/N 190-00181-02
Garmin [500 Series unit] Maintenance Manual, P/N [190-00181-05 for GNS 530, 190-00181-65 for GPS 500].
Garmin STC # [applicable STC number for the specific model installed, refer to Appendix B of this manual].
Garmin Sample Flight Manual Supplement, P/N [part number of the applicable SAFMS, refer to section 3.1 of this manual].
Garmin [500 Series unit] Pilot's Guide, P/N [part number of the applicable Pilot's Guide].

Distribution: This document should be a permanent aircraft record.

2. Description of the Alteration

Installation of the Garmin [500 Series unit], with interface to external altitude encoder and CDI [include other equipment/systems as appropriate]. Refer to section 4 of this manual for interconnect information. Antenna installation, removal and replacement should be in accordance with applicable provisions of AC43.13-1B and 43.13-2A.

3. Control, Operation Information

Refer to the [500 Series unit] Pilot's Guide.

4. Servicing Information

N/A

5. Maintenance Instructions

Maintenance of the [500 Series unit] is 'on condition' only. Periodic maintenance is not required. Refer to the [500 Series unit] Maintenance Manual.

6. Troubleshooting Information

Refer to the [500 Series unit] Maintenance Manual.

7. Removal and Replacement Information

Refer to section 3.8 of this manual. If the unit is removed and reinstalled, a functional check of the equipment should be conducted in accordance with section 5.3 of this manual.

8. Diagrams

Refer to sections 3 and 4 of this manual.

9. Special Inspection Requirements

N/A

10. Application of Protective Treatments

N/A

11. Data: Relative to Structural Fasteners

Antenna installation, removal and replacement should be in accordance with applicable provisions of AC43.13-1A and 43.13-2A. Also, refer to section 3.7 of this manual.

12. Special Tools

N/A

13. This Section is for Commuter Category Aircraft Only

A. Electrical loads: Refer to section 1.3.2 of this manual.

B. Methods of balancing flight controls: N/A.

C. Identification of primary and secondary structures: N/A.

D. Special repair methods applicable to the airplane: Antenna installation, removal, and replacement should be in accordance with applicable provisions of AC43.13-1B and 43.13-2A.

14. Overhaul Period

No additional overhaul time limitations.

15. Airworthiness Limitation Section

Refer to the [500 Series unit] Sample Flight Manual Supplement.

16. Revision

To revise this ICA, a letter must be submitted to the local FSDO with a copy of the revised FAA Form 337, and revised ICA. The FAA inspector accepts the change by signing Block 3 and including the following statement:

“The attached revised/new Instructions for Continued Airworthiness (date _____) for the above aircraft or component major alteration have been accepted by the FAA, superseding the Instructions for Continued Airworthiness (date _____).”

17. Assistance

Flight Standards Inspectors have the resources to respond to questions regarding the ICA.

18. Implementation and Record Keeping

For major alterations performed in accordance with FAA field approval policy, the owner/operator operating under Part 91 is responsible for ensuring that the ICA is made part of the applicable section 91.409 inspection program for their aircraft. This is accomplished when a maintenance entry is made in the aircraft's maintenance record in accordance with section 43.9. This entry records the major alteration and identifies the original ICA location (e.g., Block 8 of FAA Form 337, dated _____) along with a statement that the ICA is now part of the aircraft's inspection/maintenance requirements.

19. Terrain Database

Refer to the “400/500 Series Garmin Display Interfaces Pilot’s Guide Addendum” for terrain database update, regionalization, and status information.

A.2 Environmental Qualification Form—GNS 530

NOMENCLATURE: GNS 530 Airborne GPS/VOR/ILS/COM System

TYPE/MODEL/PART NO.: 010-00182-(), which includes 011-00550-()

TSO/JTSO COMPLIANCE: TSO-C129a Class A (1) (GPS)
 TSO-C37d Class 4 & 6, JTSO-2C37e (COM TRANSMITTER)
 TSO-C38d Class C & E, JTSO-2C38e (COM RECEIVER)
 TSO-C40c, JTSO-2C40c (VOR RECEIVER)
 TSO-C36e, JTSO-C36e (LOCALIZER RECEIVER)
 TSO-C34e, JTSO-C34e (GLIDESLOPE RECEIVER)

MANUFACTURER'S SPECIFICATION AND/OR OTHER

APPLICABLE SPECIFICATION: 004-00044-00

MANUFACTURER: Garmin International, Inc.

ADDRESS: 1200 E. 151st Street, Olathe, Kansas 66062

NOTE: The following information provides examples only. It is not intended to be a comprehensive listing of all test conditions.

Conditions	Section	Description of Conducted Tests
Temperature and Altitude	4.0	Equipment tested to Categories A1 & D1 except as noted
Low Temperature	4.5.1	
High Temperature	4.5.2. & 4.5.3	
In-flight Loss of Cooling	4.5.4	Not tested. External cooling is recommended but not required.
Altitude	4.6.1	
Decompression	4.6.2	
Overpressure	4.6.3	Not tested
Temperature Variation	5.0	Equipment tested to Category C
Humidity	6.0	Equipment tested to Category A
Shock	7.0	
Operational	7.2	Equipment tested per DO-160C, Par. 7.2.1
Crash Safety	7.3	Equipment tested per DO-160C, Par. 7.3.1 and 7.3.2
Vibration	8.0	Equipment tested without shock mounts to Categories B, M & N
Explosion	9.0	Equipment identified as Category X, no test required
Waterproofness	10.0	Equipment identified as Category X, no test required
Fluids Susceptibility	11.0	Equipment identified as Category X, no test required
Sand and Dust	12.0	Equipment identified as Category X, no test required
Fungus	13.0	Equipment identified as Category X, no test required
Salt Spray	14.0	Equipment identified as Category X, no test required
Magnetic Effect	15.0	Equipment tested is Class Z
Power Input	16.0	Equipment tested to Category B
Voltage Spike	17.0	Equipment tested to Category A
Audio Frequency Susceptibility	18.0	Equipment tested to Category B
Induced Signal Susceptibility	19.0	Equipment tested to Category A
Radio Frequency Susceptibility	20.0	Equipment tested to Category T
Radio Frequency Emission	21.0	Equipment tested to Category Z
Lightning Induced Transient Susc.	22.0	Equipment tested to Category ZZZZ per DO-160D. See report 005-00096-72 for details
Lightning Direct Effects	23.0	Equipment identified as Category X, no test required
Icing	24.0	Equipment identified as Category X, no test required

A.3 Environmental Qualification Form—GNS 530 w/TAWS

NOMENCLATURE: GNS 530 Airborne GPS/VOR/ILS/COM System with TAWS

TYPE/MODEL/PART NO.: 010-00325-(), which includes 011-00940-()

TSO/JTSO COMPLIANCE: TSO-C129a Class A (1) (GPS)
 TSO-C37d Class 4 & 6, JTSO-2C37e (COM TRANSMITTER)
 TSO-C38d Class C & E, JTSO-2C38e (COM RECEIVER)
 TSO-C40c, JTSO-2C40c (VOR RECEIVER)
 TSO-C36e, JTSO-C36e (LOCALIZER RECEIVER)
 TSO-C34e, JTSO-C34e (GLIDESLOPE RECEIVER)
 TSO-C151b Class B (TAWS)

MANUFACTURER’S SPECIFICATION AND/OR OTHER

APPLICABLE SPECIFICATION: 004-00044-00

MANUFACTURER: Garmin International, Inc.

ADDRESS: 1200 E. 151st Street, Olathe, Kansas 66062

NOTE: The following information provides examples only. It is not intended to be a comprehensive listing of all test conditions.

Conditions	Section	Description of Conducted Tests
Temperature and Altitude	4.0	Equipment tested to Categories A1 & D1 except as noted
Low Temperature	4.5.1	
High Temperature	4.5.2. & 4.5.3	
In-flight Loss of Cooling	4.5.4	Not tested. External cooling is recommended but not required.
Altitude	4.6.1	
Decompression	4.6.2	
Overpressure	4.6.3	Not tested
Temperature Variation	5.0	Equipment tested to Category C
Humidity	6.0	Equipment tested to Category A
Shock	7.0	
Operational	7.2	Equipment tested per DO-160C, Par. 7.2.1
Crash Safety	7.3	Equipment tested per DO-160C, Par. 7.3.1 and 7.3.2
Vibration	8.0	Equipment tested without shock mounts to Categories B, M & N
Explosion	9.0	Equipment identified as Category X, no test required
Waterproofness	10.0	Equipment identified as Category X, no test required
Fluids Susceptibility	11.0	Equipment identified as Category X, no test required
Sand and Dust	12.0	Equipment identified as Category X, no test required
Fungus	13.0	Equipment identified as Category X, no test required
Salt Spray	14.0	Equipment identified as Category X, no test required
Magnetic Effect	15.0	Equipment tested is Class Z
Power Input	16.0	Equipment tested to Category B
Voltage Spike	17.0	Equipment tested to Category A
Audio Frequency Susceptibility	18.0	Equipment tested to Category B
Induced Signal Susceptibility	19.0	Equipment tested to Category A
Radio Frequency Susceptibility	20.0	Equipment tested to Category T
Radio Frequency Emission	21.0	Equipment tested to Category Z
Lightning Induced Transient Susc.	22.0	Equipment tested to Category ZZZZ per DO-160D. See report 005-00096-72 for details
Lightning Direct Effects	23.0	Equipment identified as Category X, no test required
Icing	24.0	Equipment identified as Category X, no test required

A.4 Environmental Qualification Form—GNS 530A

NOMENCLATURE: GNS 530A Airborne GPS/VOR/ILS/COM System

TYPE/MODEL/PART NO.: 010-00285-(), which includes 011-00835-()xxxxx

TSO/JTSO COMPLIANCE: TSO-C129a Class A (1), JTSO C129a (GPS)
 TSO-C37d Class 3 & 5, JTSO-2C37e (COM TRANSMITTER)
 TSO-C38d Class C & E, JTSO-2C38e (COM RECEIVER)
 TSO-C40c, JTSO-2C40c (VOR RECEIVER)
 TSO-C36e, JTSO-C36e (LOCALIZER RECEIVER)
 TSO-C34e, JTSO-C34e (GLIDESLOPE RECEIVER)

MANUFACTURER'S SPECIFICATION AND/OR OTHER

APPLICABLE SPECIFICATION: 004-00044-00

MANUFACTURER: Garmin International, Inc.

ADDRESS: 1200 E. 151st Street, Olathe, Kansas 66062

NOTE: The following information provides examples only. It is not intended to be a comprehensive listing of all test conditions.

Conditions	Section	Description of Conducted Tests
Temperature and Altitude	4.0	Equipment tested to Categories A1 & D1 except as noted
Low Temperature	4.5.1	
High Temperature	4.5.2. & 4.5.3	
In-flight Loss of Cooling	4.5.4	Not tested. External cooling is recommended but not required.
Altitude	4.6.1	
Decompression	4.6.2	
Overpressure	4.6.3	Not tested
Temperature Variation	5.0	Equipment tested to Category C
Humidity	6.0	Equipment tested to Category A
Shock	7.0	
Operational	7.2	Equipment tested per DO-160C, Par. 7.2.1
Crash Safety	7.3	Equipment tested per DO-160C, Par. 7.3.1 and 7.3.2
Vibration	8.0	Equipment tested without shock mounts to Categories B, M & N
Explosion	9.0	Equipment identified as Category X, no test required
Waterproofness	10.0	Equipment identified as Category X, no test required
Fluids Susceptibility	11.0	Equipment identified as Category X, no test required
Sand and Dust	12.0	Equipment identified as Category X, no test required
Fungus	13.0	Equipment identified as Category X, no test required
Salt Spray	14.0	Equipment identified as Category X, no test required
Magnetic Effect	15.0	Equipment tested is Class Z
Power Input	16.0	Equipment tested to Category B
Voltage Spike	17.0	Equipment tested to Category A
Audio Frequency Susceptibility	18.0	Equipment tested to Category B
Induced Signal Susceptibility	19.0	Equipment tested to Category A
Radio Frequency Susceptibility	20.0	Equipment tested to Category T
Radio Frequency Emission	21.0	Equipment tested to Category Z
Lightning Induced Transient Susc.	22.0	Equipment tested to Category ZZZZ per DO-160D. See report 005-00096-72 for details
Lightning Direct Effects	23.0	Equipment identified as Category X, no test required
Icing	24.0	Equipment identified as Category X, no test required

A.5 Environmental Qualification Form—GNS 530A w/TAWS

NOMENCLATURE: GNS 530A Airborne GPS/VOR/ILS/COM System with TAWS

TYPE/MODEL/PART NO.: 010-00292-(), which includes 011-00864-()

TSO/JTSO COMPLIANCE: TSO-C129a Class A (1), JTSO C129a (GPS)
 TSO-C37d Class 3 & 5, JTSO-2C37e (COM TRANSMITTER)
 TSO-C38d Class C & E, JTSO-2C38e (COM RECEIVER)
 TSO-C40c, JTSO-2C40c (VOR RECEIVER)
 TSO-C36e, JTSO-C36e (LOCALIZER RECEIVER)
 TSO-C34e, JTSO-C34e (GLIDESLOPE RECEIVER)
 TSO-C151b Class B (TAWS)

MANUFACTURER'S SPECIFICATION AND/OR OTHER

APPLICABLE SPECIFICATION: 004-00044-00

MANUFACTURER: Garmin International, Inc.

ADDRESS: 1200 E. 151st Street, Olathe, Kansas 66062

NOTE: The following information provides examples only. It is not intended to be a comprehensive listing of all test conditions.

Conditions	Section	Description of Conducted Tests
Temperature and Altitude	4.0	Equipment tested to Categories A1 & D1 except as noted
Low Temperature	4.5.1	
High Temperature	4.5.2. & 4.5.3	
In-flight Loss of Cooling	4.5.4	Not tested. External cooling is recommended but not required.
Altitude	4.6.1	
Decompression	4.6.2	
Overpressure	4.6.3	Not tested
Temperature Variation	5.0	Equipment tested to Category C
Humidity	6.0	Equipment tested to Category A
Shock	7.0	
Operational	7.2	Equipment tested per DO-160C, Par. 7.2.1
Crash Safety	7.3	Equipment tested per DO-160C, Par. 7.3.1 and 7.3.2
Vibration	8.0	Equipment tested without shock mounts to Categories B, M & N
Explosion	9.0	Equipment identified as Category X, no test required
Waterproofness	10.0	Equipment identified as Category X, no test required
Fluids Susceptibility	11.0	Equipment identified as Category X, no test required
Sand and Dust	12.0	Equipment identified as Category X, no test required
Fungus	13.0	Equipment identified as Category X, no test required
Salt Spray	14.0	Equipment identified as Category X, no test required
Magnetic Effect	15.0	Equipment tested is Class Z
Power Input	16.0	Equipment tested to Category B
Voltage Spike	17.0	Equipment tested to Category A
Audio Frequency Susceptibility	18.0	Equipment tested to Category B
Induced Signal Susceptibility	19.0	Equipment tested to Category A
Radio Frequency Susceptibility	20.0	Equipment tested to Category T
Radio Frequency Emission	21.0	Equipment tested to Category Z
Lightning Induced Transient Susc.	22.0	Equipment tested to Category ZZZZ per DO-160D. See report 005-00096-72 for details
Lightning Direct Effects	23.0	Equipment identified as Category X, no test required
Icing	24.0	Equipment identified as Category X, no test required

A.6 Environmental Qualification Form—GPS 500

NOMENCLATURE: GPS 500 Airborne GPS System
TYPE/MODEL/PART NO.: 010-00176-(), which includes 011-00562-()
TSO/JTSO COMPLIANCE: TSO-C129a Class A (1) (GPS)
MANUFACTURER'S SPECIFICATION AND/OR OTHER APPLICABLE SPECIFICATION: 004-00044-00
MANUFACTURER: Garmin International, Inc.
ADDRESS: 1200 E. 151st Street, Olathe, Kansas 66062

NOTE: The following information provides examples only. It is not intended to be a comprehensive listing of all test conditions.

Conditions	Section	Description of Conducted Tests
Temperature and Altitude	4.0	Equipment tested to Categories A1 & D1
Low Temperature	4.5.1	
High Temperature	4.5.2. & 4.5.3	
In-flight Loss of Cooling	4.5.4	Equipment tested to Category Y
Altitude	4.6.1	
Decompression	4.6.2	
Overpressure	4.6.3	Not tested
Temperature Variation	5.0	Equipment tested to Category C
Humidity	6.0	Equipment tested to Category A
Shock	7.0	Equipment tested per DO-160C, Par. 7.2.1
Operational	7.2	
Crash Safety	7.3	
Vibration	8.0	Equipment tested without shock mounts to Categories B, M & N
Explosion	9.0	Equipment identified as Category X, no test required
Waterproofness	10.0	Equipment identified as Category X, no test required
Fluids Susceptibility	11.0	Equipment identified as Category X, no test required
Sand and Dust	12.0	Equipment identified as Category X, no test required
Fungus	13.0	Equipment identified as Category X, no test required
Salt Spray	14.0	Equipment identified as Category X, no test required
Magnetic Effect	15.0	Equipment tested is Class Z
Power Input	16.0	Equipment tested to Category B
Voltage Spike	17.0	Equipment tested to Category A
Audio Frequency Susceptibility	18.0	Equipment tested to Category B
Induced Signal Susceptibility	19.0	Equipment tested to Category A
Radio Frequency Susceptibility	20.0	Equipment tested to Category T
Radio Frequency Emission	21.0	Equipment tested to Category Z
Lightning Induced Transient Susc.	22.0	Equipment tested to Category ZZZZ per DO-160D. See report 005-00096-72 for details
Lightning Direct Effects	23.0	Equipment identified as Category X, no test required
Icing	24.0	Equipment identified as Category X, no test required

A.7 Environmental Qualification Form—GPS 500 w/TAWS

NOMENCLATURE: GPS 500 Airborne GPS System with TAWS

TYPE/MODEL/PART NO.: 010-00291-(), which includes 011-00863-()

TSO/JTSO COMPLIANCE: TSO-C129a Class A (1) (GPS)
TSO-C151b Class B (TAWS)

MANUFACTURER'S SPECIFICATION AND/OR OTHER

APPLICABLE SPECIFICATION: 004-00044-00

MANUFACTURER: Garmin International, Inc.

ADDRESS: 1200 E. 151st Street, Olathe, Kansas 66062

NOTE: The following information provides examples only. It is not intended to be a comprehensive listing of all test conditions.

Conditions	Section	Description of Conducted Tests
Temperature and Altitude	4.0	Equipment tested to Categories A1 & D1
Low Temperature	4.5.1	
High Temperature	4.5.2. & 4.5.3	
In-flight Loss of Cooling	4.5.4	Equipment tested to Category Y
Altitude	4.6.1	
Decompression	4.6.2	
Overpressure	4.6.3	Not tested
Temperature Variation	5.0	Equipment tested to Category C
Humidity	6.0	Equipment tested to Category A
Shock	7.0	Equipment tested per DO-160C, Par. 7.2.1
Operational	7.2	
Crash Safety	7.3	
Vibration	8.0	Equipment tested without shock mounts to Categories B, M & N
Explosion	9.0	Equipment identified as Category X, no test required
Waterproofness	10.0	Equipment identified as Category X, no test required
Fluids Susceptibility	11.0	Equipment identified as Category X, no test required
Sand and Dust	12.0	Equipment identified as Category X, no test required
Fungus	13.0	Equipment identified as Category X, no test required
Salt Spray	14.0	Equipment identified as Category X, no test required
Magnetic Effect	15.0	Equipment tested is Class Z
Power Input	16.0	Equipment tested to Category B
Voltage Spike	17.0	Equipment tested to Category A
Audio Frequency Susceptibility	18.0	Equipment tested to Category B
Induced Signal Susceptibility	19.0	Equipment tested to Category A
Radio Frequency Susceptibility	20.0	Equipment tested to Category T
Radio Frequency Emission	21.0	Equipment tested to Category Z
Lightning Induced Transient Susc.	22.0	Equipment tested to Category ZZZZ per DO-160D. See report 005-00096-72 for details
Lightning Direct Effects	23.0	Equipment identified as Category X, no test required
Icing	24.0	Equipment identified as Category X, no test required

A.8 Environmental Qualification Form—GA 56

NOMENCLATURE: GA 56, GPS Aviation Antenna

TYPE/MODEL/PART NO.: 011-00134-00 (Stud Mount)
011-00147-00 (Flange Mount)

TSO COMPLIANCE: C129 Class A (1)

MANUFACTURER'S SPECIFICATION AND/OR OTHER APPLICABLE SPECIFICATION: 004-00015-00

MANUFACTURER: Garmin International, Inc.

ADDRESS: 1200 E. 151st Street, Olathe, Kansas 66062

NOTE: The following information provides examples only. It is not intended to be a comprehensive listing of all test conditions.

Conditions	Section	Description of Conducted Tests
Temperature and Altitude	4.0	Equipment tested to Category F2
Low Temperature	4.5.1	
High Temperature	4.5.2. & 4.5.3	
In-flight Loss of Cooling	4.5.4	Cooling air not required
Altitude	4.6.1	
Decompression	4.6.2	Not tested
Overpressure	4.6.3	Not tested
Temperature Variation	5.0	Equipment tested to Category A
Humidity	6.0	Equipment tested to Category C
Shock	7.0	Equipment tested per DO-160C, Par. 7.2.1
Operational	7.2	
Crash Safety	7.3	Not Applicable
Vibration	8.0	Equipment tested without shock mounts to Categories C, L, M & Y
Explosion	9.0	Equipment identified as Category X, no test required
Waterproofness	10.0	Equipment tested to Category S
Fluids Susceptibility	11.0	Equipment tested to Category F with Ethylene Glycol De-Icing Fluid
Sand and Dust	12.0	Equipment identified as Category X, no test required
Fungus	13.0	Equipment identified as Category X, no test required
Salt Spray	14.0	Equipment identified as Category X, no test required
Magnetic Effect	15.0	Equipment identified as Category X, no test required
Power Input	16.0	Equipment identified as Category X, no test required
Voltage Spike	17.0	Equipment identified as Category X, no test required
Audio Frequency Susceptibility	18.0	Equipment identified as Category X, no test required
Induced Signal Susceptibility	19.0	Equipment tested to Category A
Radio Frequency Susceptibility	20.0	Equipment tested to Category T
Radio Frequency Emission	21.0	Equipment tested to Category Z
Lightning Induced Transient Susc.	22.0	Equipment identified as Category XXXX, no test required
Lightning Direct Effects	23.0	Equipment tested to Category 2A
Icing	24.0	Equipment tested to Category C

Appendix B. STC PERMISSION

Consistent with N8110.69 or Order 8110.4, Aviation Authority approved installers are hereby granted permission to use STC #SA00864WI (GNS 530/GNS 530A/GPS 500) data (pages B-2 and B-3) to modify aircraft. Pages B-4 and B-5 provide clarification as to the approval basis for the Garmin GNS 430 without external switching or annunciation. There is a great degree of similarity between the switching and annunciation characteristics of the 500 Series units and of the GNS 430. In addition, the following is excerpted from a Federal Aviation Administration (FAA) memorandum titled, "INFORMATION: Q & A from Seattle Avionics Workshop - (Navigation Related)", dated July 12, 1999.

"The horizontal (and vertical) deviations display(s) and failure annunciation should be located within the pilot's primary field of view (i.e., within 15 degrees of the pilot's primary line of sight), as should any indication requiring immediate aircrew action. Other annunciations should be installed in the normal field of view (e.g., a location in the center radio stack or other location on the pilot's panel within the field of view at a height suitable for normal viewing from the pilot's seated position). This includes loss of integrity monitoring (RAIM), waypoint sequencing, start of a turn, turn anticipation, TO/FROM indication, approach mode annunciation and automatic mode switching."

Pages B6 and B7 document the FAA design approval, indicating compliance with FAA Notice N8110.60. As such, the 500 Series, with Main SW 3.0 or later FAA approved SW meets the requirements for GPS primary means of navigation in oceanic and remote airspace, when used in conjunction with the 400 Series Trainer Program incorporating the FDE Prediction Program. FAA design approval does not constitute an operational approval. Refer to N8110.60 when seeking operational approval for GPS as the primary means of navigation.

Contact Garmin for STC information regarding TAWS.

United States of America
Department of Transportation -- Federal Aviation Administration
Supplemental Type Certificate

Number SA00864WI

This certificate issued to GARMIN International
1200 E 51st St.
Olathe, KS 66062

certifies that the change in the type design for the following product with the limitations and conditions therefor as specified hereon meets the airworthiness requirements of Part 3 of the Civil Air Regulations.

Original Product - Type Certificate Number : A3SO
Make : Piper
Model : PA-32-260

Description of Type Design Change: Installation of the GARMIN GNS 530 or GNS 530A or GPS 500 in accordance with the data listed on the Continuation Sheet.

Limitations and Conditions : Compatibility of this design change with previously approved modifications must be determined by the installer. If the holder agrees to permit another person to use this certificate to alter the product, the holder shall give the other person written evidence of that permission.

This certificate and the supporting data which is the basis for approval shall remain in effect until surrendered, suspended, revoked or a termination date is otherwise established by the Administrator of the Federal Aviation Administration.

Date of application : November 10, 1998

Date reissued :

Date of issuance : March 21, 2000

Date amended : April 13, 2001; July 25, 2002



By direction of the Administrator
Harvey E. Nero
(Signature)

Harvey E. Nero
Program Manager
Wichita Aircraft Certification Office

(Title)

Any alteration of this certificate is punishable by a fine of not exceeding \$1,000, or imprisonment not exceeding 3 years, or both.
FAA FORM 8110-2(10-68) PAGE 1 of 2 PAGES This certificate may be transferred in accordance with FAR 21.47.

United States of America
Department of Transportation - Federal Aviation Administration
Supplemental Type Certificate
(Continuation Sheet)

Number SA00864WI

Configuration 1

Installation of the GARMIN GNS 530 or GNS 530A in accordance with GARMIN Master Drawing List 005-C0097-00, Revision H, dated 04/26/02 or later FAA Approved revision, and Airplane Flight Manual Supplement for Piper PA-32 with GARMIN 530, GARMIN Drawing number 190-00181-03, Revision A, dated 04/04/00 or later FAA Approved revision.

Configuration 2

Installation of the GARMIN GPS 500 in accordance with GARMIN Master Drawing List 005-C0097-00, Revision H, dated 04/26/02 or later FAA Approved revision, and Airplane Flight Manual Supplement for Piper PA-32 with GARMIN 530, GARMIN Drawing number 190-00181-63, Revision A, dated 03/15/01 or later FAA Approved revision.

Any alteration of this certificate is punishable by a fine of not exceeding \$1,000, or imprisonment not exceeding 3 years, or both.
FAA FORM 8110-2-1(10-69) PAGE 2 of 2 PAGES This certificate may be transferred in accordance with FAR 21.47.



INSTALLATION MEMORANDUM

TO: GARMIN Authorized Dealers
FROM: GARMIN International
DATE: January 25, 1999
SUBJECT: GNS 430 approval basis without external switching or annunciation
CC: Wichita Aircraft Certification Office

Due to reluctance by GARMIN Authorized Dealers and FAA Flight Standard District Office Field Inspectors to install and approve GARMIN GNS 430 Integrated VHF Communications, VHF Navigation and GPS Receiver equipment in certain installations, GARMIN is issuing this letter to clarify the approval basis for accomplishing such installations without external switching or annunciation.

GARMIN obtained initial TSO and STC approval under TSO-C129(a) in conjunction with AC 20-138 for the GPS Receiver of the GNS 430 in a Piper Cherokee PA32-260 without external switching or annunciation. The certification was accomplished under the jurisdiction of the Wichita Aircraft Certification Office with the basis for approval as follows:

1. The GNS 430 was panel mounted in the center radio stack. Normal field of view has been interpreted to be from the airspeed indicator to and including the center radio stack. Therefore, mounting of the GNS 430 was accomplished in the pilot's normal field of view.
2. GPS receiver mode, CDI source information, leg sequencing, loss of integrity (RAIM), message and waypoint alert annunciations are located on the GNS 430 display. Color and size of these annunciations were chosen to provide optimal recognition and color association with the related condition. Both color and size were a determining factor in this approval.
3. The GNS 430 CDI source information switching is accomplished internally, therefore the switch used to determine the source of CDI source information on the associated indicator is located on the GNS 430.

Follow-on IFR airworthiness approval was accomplished under the STC process on a Mooney M20J incorporating dual GNS 430 receivers. Approval was granted on the Mooney installation without the requirement for external switching or annunciation under the same guidance aforementioned. Installations which deviate from this guidance may have additional requirements imposed such as external annunciation. The GNS 430 provides interfaces for such installations.

For the Piper Cherokee PA32-260 approval, reference STC SA00705W1 dated October 2, 1998. For the Mooney M20J dual GNS 430 installation, reference STC SA00735W1 dated January 19, 1999. Also see the attached Wichita ACO letter affirming approval of the GNS 430 system without external switching or annunciation and guidance to consider when installing GNS 430 systems to avoid external switching and annunciation.

Sincerely,

A handwritten signature in black ink that reads "Bill Stone".

Bill Stone
Avionics Product Manager



U.S. Department
of Transportation
**Federal Aviation
Administration**

Small Airplane Directorate
Wichita Aircraft Certification Office
1801 Airport Road, Room 100
Wichita, Kansas 67209

January 25, 1999

Mr. Phil Straub
GARMIN International
1200 E. 151st St.
Olathe, KS 66062

Subject: GNS 430 Follow On Installation Approval

Reference: GARMIN Installation Memorandum dated January 25, 1999

Dear Mr. Straub:

We have reviewed your Installation Memorandum dated January 25, 1999, and concur with the contents.

The GNS 430 integrated navigation/communication system incorporates adequate internal switching, alerting and annunciation features within its display such that most typical installations will not require external switching or annunciation. Extensive evaluations were conducted during initial certification of the GNS 430 to verify the suitability of the switching, alerting and annunciation features of the system. External annunciation of GPS receiver mode, CDI source information, leg sequencing, loss of integrity (RAIM), message and waypoint alert are not required in most installations where the GNS 430 display is located in the center area of the vertical instrument panel. For most aircraft, a location in the center radio stack or other location on the pilot's panel within the normal field of view at a height suitable for normal viewing from the pilot's seated position will not require external switching or annunciators. This area is generally defined as between the airspeed indicator on the left, the center radio stack (or left side of dual center radio stack arrangements) on the right, and vertically such that it is not blocked by the glare shield on top and not below the instrument panel or blocked by throttles, control yoke, etc. on the bottom. Installations located outside of this area (i.e., in a center pedestal, on the opposite side of the aircraft from the pilot's station, on a tilt panel, behind throttles, etc.) may require external annunciators.

Sincerely,

A handwritten signature in black ink that reads "C. Dale Bleakney". The signature is fluid and cursive, with a long horizontal stroke at the end.

C. Dale Bleakney
FAA Program Manager
Wichita Aircraft Certification Office



U.S. Department
of Transportation
**Federal Aviation
Administration**

Small Airplane Directorate
Wichita Aircraft Certification Office
1801 Airport Road, Room 100
Wichita, Kansas 67209

September 4, 2002

Mr. Robert W. Billings
GARMIN INTERNATIONAL
1200 East 151st Street
Olathe, KS 66062

Subject: GARMIN GNC 500 Series Notice 8110.60 Data Submittal

Reference: (1) GARMIN letter dated August 27, 2002
(2) FAA Notice 8110.60, GPS as a Primary Means of Navigation for
Oceanic/Remote Operations
(3) FAA Information Memorandum: GPS as a Primary Means of Navigation,
dated 2/11/97

Dear Mr. Billings:

This is in reply to your letter of August 27, 2002, requesting a separate letter of design approval for your upgrade to the GNC 500 series of products to comply with FAA Notice 8110.60. We concur that GARMIN International has met the requirements of Notice 8110.60 in accordance with the additional guidance provided in the FAA Information Memorandum: GPS as a Primary Means of Navigation, dated 2/11/97, and as agreed upon in GNC 400/500 Plan for Software Aspects of Certification for FDE (GPN 005-00077-63, Revision A).

GARMIN has previously received TSO-C129a, Airborne Supplemental Navigation Equipment Using the Global Positioning System (GPS), Class A1 TSO Authorization for the GNC 500 series products through our office.

The GNC 500 series software has been developed in accordance with DO-178B for Level C software as documented in GNC 500 Software Accomplishment Summary (GPN 005-00096-15, Revision R). The FDE Prediction Program software has been developed in accordance with DO-178B for Level D software as documented in FDE Prediction Program Software Accomplishment Summary (GPN 005-00162-04, Revision A).

A list of the technical data required by TSO-C129a (and the other TSOs) and the GARMIN document(s) which satisfy each requirement for the GNC 500 series can be found in GNC 500 Traceability Matrix (GPN 005-00096-62, Revision C). A list of the technical data required by Notice 8110.60 and the GARMIN document(s) which satisfy each requirement for the GNC 500 series and the associated FDE Prediction Program is in the GNC 500 FDE Traceability Matrix (GPN 005-00096-74, Revision A).

The GNC 500 series will be manufactured at your Olathe, Kansas, facility under quality assurance procedures contained in GARMIN Quality Assurance Procedures Manual, Revision dated 05/04/2000 or later FAA Approved revisions.

As GARMIN has previously received TSO-C129a, Class A1 TSO Authorization for the GNC 500 series products through the Wichita ACO and as GARMIN has met the additional requirements of Notice 8110.60, this letter serves as the Letter of Design Approval for Notice 8110.60, GPS as a Primary Means of Navigation for Oceanic/Remote Operations for the following GNC 500 series models and FDE Prediction Program:

Model	GARMIN Part Number (GPN)	Description
GPS 500	010-00176-()	GPS Receiver System
GNS 530	010-00182-()	GPS Receiver/10W VHF Comm/VOR/LOC/Glide Slope System
GNS 530A	010-00285-()	GPS Receiver/16W VHF Comm/VOR/LOC/Glide Slope System
FDEPRDCT	006-A0072-00, Revision B	FDE Prediction Program Software

As agreed upon in GNC 400/500 Plan for Software Aspects of Certification for FDE (GPN 005-00077-63, Revision A), these changes have been approved as minor TSOA design changes, and GARMIN may distribute this upgrade upon receipt of this Letter of Design Approval.

Additionally, the Service Bulletin addressing this software upgrade will indicate that for those aircraft installations that desire Oceanic/Remote operation approval, the AFM(S) must be amended per Notice 8110.60 paragraph 6c.

We will retain your letter and the data listed in the enclosure. We have received data that is new for this application. Other related documentation is already on file for the previously approved GNC 500 series of products.

If you have questions regarding this authorization, please contact me at 316-946-4134.

Sincerely,

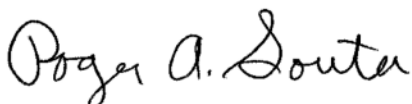

Roger A. Souter
Aerospace Safety Engineer
Electrical and Mechanical Systems
Wichita Aircraft Certification Office

Enclosure



U.S. Department
of Transportation
**Federal Aviation
Administration**

Small Airplane Directorate
Wichita Aircraft Certification Office
1801 Airport Road, Room 100
Wichita, Kansas 67209

July 25, 2002

Mr. Ric Sleigh
GARMIN International
1200 East 151st Street
Olathe, KS 66062

Subject: Amended Supplemental Type Certificate (STC) SA00864WI

Reference: (1) FAA Project Number ST2166WI-A
(2) GARMIN letter dated July 19, 2002

Dear Mr. Sleigh:

Enclosed is Amended Supplemental Type Certificate (STC) SA00864WI, dated July 25, 2002, indicating our approval of the installation of the GARMIN GNS 530, GNS 530A, or GPS 500 on a Piper PA-32-260.

Also enclosed is the FAA Approved GARMIN Master Drawing List, Drawing Number 005-C0097-00, Revision H, dated 04/26/02. The STC references the drawing list as the controlling document for the installation. A copy of the drawing list and data listed therein will be retained in our files.

Signed copies of FAA Approved Airplane Flight Manual Supplement (AFMS) for Piper PA32 with GARMIN GNS 530, Document No. 190-00181-03, Revision A, dated 4/4/00 and FAA Approved Airplane Flight Manual Supplement (AFMS) for Piper PA32 with GARMIN GPS 500, Document No. 190-00181-63, Revision A, dated 3/15/01, have already been provided to you.

Sincerely,

A handwritten signature in black ink, appearing to read "Harvey E. Nero".

Harvey E. Nero
Program Manager
Wichita Aircraft Certification Office

Enclosure

Appendix C. 500 SERIES RS-232 AVIATION DATA FORMAT

C.1 ELECTRICAL INTERFACE

The output signals shall be compatible with RS-232C. Data shall be generated at 9600 baud with a word length of 8 bits, one stop bit, and no parity.

C.2 GENERAL OUTPUT FORMAT

The 500 Series RS-232 data shall have the following general format:

- STX - ASCII start-of-text character (02 hex)
- t1s - Type 1 output sentences (see following paragraphs for description)
- t2s - One or more type 2 output sentences (see following paragraphs for description)
- ETX - ASCII end-of-text character (03 hex)

C.3 OUTPUT SENTENCE TYPE 1

The Type 1 output sentences shall have the following general format:

- id - item designator (single ASCII alphabetic character)
- dddd - item data (1 to 10 printable ASCII characters)
- CR - ASCII carriage return character (0D hex)
- LF - ASCII line feed character (0A hex)*

Each Type 1 sentence shall be output by the 500 Series unit approximately once every second. The track, desired track, and bearing to waypoint angles, and the magnetic variation are output according to the current mode of the 500 Series unit (automatic magnetic heading, magnetic variation computed at last known position; true heading, magnetic variation of E00.0°; or user-defined magnetic heading, magnetic variation as entered by user).

The following table describes the Type 1 output sentence item designator (id) and item data (dddd) fields. If data for these sentences is invalid or unavailable, dashes ("-") are used to fill in all non-blank character positions.

Ident (1 byte)	Data (10 bytes)	Description
	1 2 3 4 5 6 7 8 9 0	
Z	a a a a a	Current GPS altitude in feet *
A	s d d m m h h	Current latitude, where: s - N (north) or S (south) dd - degrees mm - minutes hh - hundredths of minutes
B	s d d d m m h h	Current longitude, where: s - E (east) or W (west) ddd - degrees mm - minutes hh - hundredths of minutes
C	d d d	Track in whole degrees
D	s s s	Ground speed in knots
E	d d d d d	Distance to waypoint in tenths of nautical miles
G	s n n n n	Cross track error, where: s - L (left) or R (right) of course nnnn - error in hundredths of nautical miles
I	d d d d	Desired track in tenths of degrees
K	c c c c c	Destination waypoint identifier (will be blank filled on right if less than 5 characters in identifier)
L	d d d d	Bearing to destination waypoint in tenths of degrees
Q	s d d d	Magnetic variation, where: s - E (east) or W (west) ddd - tenths of degrees
S	- - - - f	Nav valid flag status, where: f - N (nav flagged) or - (nav valid)
T	- - - - -	Warnings status, only data transmitted are dashes (-). Used to indicate end of Type 1 sentences.
I (lower case Lima)	d d d d d d	Distance to destination waypoint in tenths of nautical miles.

* The altitude is not output if the RS-232 port is configured as "Avtn no alt".

* The line feed character is not output if the RS-232 port is configured as "Avtn no alt".

C.4 OUTPUT SENTENCE TYPE 2

The 500 Series Type 2 output sentence shall have the following general format:

- id - item designator (3 ASCII characters)
- seq - sequence number (1 binary byte)
- wpt - waypoint identifier (5 ASCII characters)
- lat - waypoint latitude (3 binary bytes)
- lon - waypoint longitude (4 binary bytes)
- mvar - magnetic variation at waypoint (2 binary bytes)
- CR - ASCII carriage return character (0D hex)
- LF - ASCII line feed character (0A hex)

Each waypoint in the route being navigated by the 500 Series unit shall have a Type 2 sentence output by the 500 Series unit approximately once every second.

If no route is being navigated by the 500 Series unit (i.e., the active route is empty), the following Type 2 sentence is output approximately once every second:

- id - item designator (3 ASCII characters; route sequence number is "01")
- seq - sequence number (1 binary byte; last waypoint flag is set; route sequence number is 1)
- CR - ASCII carriage return character (0D hex)
- LF - ASCII line feed character (0A hex)

The following table describes the Type 2 output sentence item designator (id), sequence number (seq), waypoint identifier (wpt), waypoint latitude (lat), waypoint longitude (lon), and magnetic variation at waypoint (mvar) fields.

Field	Byte	Format	Description
		7 6 5 4 3 2 1 0	
id	1		ASCII character 'w' (77 hex)
	2-3		Two ASCII numeric characters representing route sequence number of waypoint (01 to 31)
seq	1	x l a n n n n n	x - undefined l - 1 if last waypoint in route a - 1 if active to waypoint nnnnn - route sequence number of waypoint (unsigned binary)
wpt	1-5		Destination waypoint identifier (will be blank filled on right if less than 5 characters in identifier)
lat	1	s d d d d d d d	s - 0 (north) or 1 (south) dddddd - latitude degrees (unsigned binary)
	2	x x m m m m m m	xx - undefined mmmmm - latitude minutes (unsigned binary)
	3	x h h h h h h h	x - undefined hhhhhh - hundredths of latitude minutes (unsigned binary)
lon	1	s x x x x x x x	s - 0 (north) or 1 (south) xxxxxx - undefined
		d d d d d d d d	ddddddd - longitude degrees (unsigned binary)
		x x m m m m m m	xx - undefined mmmmm - latitude minutes (unsigned binary)
		x h h h h h h h	x - undefined hhhhhh - hundredths of latitude minutes (unsigned binary)
mvar	1-2		Two's complement binary in 16ths of degrees. Easterly variation is positive. MSB output first.

Appendix D. 500 SERIES RS-232 FUEL/AIR DATA INPUT FORMAT

D.1 ELECTRICAL INTERFACE

The input signals shall be compatible with RS-232C. Data shall be input at 9600 baud with a word length of 8 bits, one stop bit, and no parity. One message is received per second.

D.2 SHADIN ALTITUDE SENTENCE

The Garmin 500 Series units shall be capable of receiving the following 17-byte message from Shadin Altitude Encoders, Altitude Serializers, and Altitude Converters:

RMS<sp><+/->12345T<+/->12ul<CR>

Where:

RMS ASCII characters
<sp> space (0x20)
<+/-> sign indicator (0x2b["+"] or 0x2d["-"])
12345 altitude in feet
T ASCII character
<+/-> sign indicator
12 sensor temperature
ul checksum of bytes 1 through 14 in hex ASCII (i.e., "FA")
<CR> carriage return (0x0d)

Note: Checksum is calculated by adding each byte in the message (1 through 14).

D.3 ICARUS ALTITUDE SENTENCE

The Garmin 500 Series units shall be capable of receiving the following 10-byte message from the Icarus Altitude Serializer:

ALT<sp>12345<CR>

Where:

ALT ASCII characters
<sp> space (0x20)
12345 altitude in feet
<CR> carriage return (0x0d)

D.4 SHADIN FUEL FLOW SENTENCE

The Garmin 500 Series units shall be capable of receiving the following 55-byte message from the Shadin Fuel Flow Indicator:

<STX>K0543.2<sp>0100.0<sp>0040.0<sp>0060.0<sp>0123.4<sp>0045.4<sp>0078.0<sp>123<ETX>

Where:

- <STX>** start-transmit character (0x02)
- K** units designation (i.e., **G**allons, **L**iters, **K**ilograms, **B**[pounds])
- 0543.2** total fuel remaining (i.e., ASCII-coded decimal format: 0x30, 0x35, 0x34, 0x33, 0x2e, 0x32)
- <sp>** space (0x20)
- 0100.0** fuel flow rate, total (formatted as for total fuel remaining)
- 0040.0** fuel flow rate, engine one (or asterisks["*****"], in the case of single engine aircraft)
- 0060.0** fuel flow rate, engine two (asterisks, in the case of single engine aircraft)
- 0123.4** fuel used, total
- 0045.4** fuel used, engine one (asterisks, in the case of single engine aircraft)
- 0078.0** fuel used, engine two (asterisks, in the case of single engine aircraft)
- 123** checksum (of bytes 2 through 51)
- <ETX>** end-transmit character (0x03)

Note: Checksum is calculated by adding each byte in the message (2 through 51), such that carries are discarded to give a one byte result. The ASCII-coded decimal representation of that byte is given, ranging from 0 (0x30, 0x30, 0x30) to 255 (0x32, 0x35, 0x35).

D.5 ARNAV / EI FUEL FLOW SENTENCE

The Garmin 500 Series units shall be capable of receiving the following 13-byte message from the ARNAV or Electronics International ("EI") Fuel Flow Indicators:

<STX>G0245100550<ETX>

Where:

- <STX>** start-transmit character (0x02 hex)
- G** units designation (i.e., **G**allons, **I**mperial gallons, **L**iters, **K**ilograms, **B**[pounds])
- 0245** total fuel remaining in reverse order (i.e., ASCII-coded decimal format: 0x30, 0x32, 0x34, 0x35)
- 1** fuel remaining checksum (modulo 10 sum of four "total fuel remaining" digits)
- 0055** total fuel flow rate in reverse order
- 0** fuel flow checksum
- <ETX>** end-transmit character (0x03)

NOTE: Fuel remaining and fuel flow are [$\ast 10$] when units designation is gallons or imperial gallons. For example, 0245 gallons indicates 542 gallons; 0245 liters indicates 5420 liters. Checksum is the modulo 10 sum of the four fuel flow decimal digits, converted to an ASCII numerical character (e.g., checksum for "5678" would be ASCII "6").

D.6 SHADIN FUEL/AIRDATA COMPUTER SENTENCE

The Garmin 500 Series units shall be capable of receiving the following message strings from the Shadin Fuel/Airdata or Airdata Computer:

D.6.1 SHADIN "Z" FORMAT

<STX>

ZA012<CR><LF>	"ZA" (ASCII characters); "012" represents indicated Air Speed (knots)
ZB345<CR><LF>	"ZB" (ASCII characters); "345" represents true Air Speed (knots)
ZC678<CR><LF>	"ZC" (ASCII characters); "678" represents Mach Speed (thousandths)
ZD<+/->9012<CR><LF>	"ZD" (ASCII characters); sign; "9012" represents pressure altitude (tens of feet)
ZE<+/->3456<CR><LF>	"ZE" (ASCII characters); sign; "3456" represents density altitude (tens of feet)
ZF<+/->78<CR><LF>	"ZF" (ASCII characters); sign; "78" represents outside air temperature (Celsius)
ZG<+/->90<CR><LF>	"ZG" (ASCII characters); sign; "90" represents true air temperature (Celsius)
ZH123<CR><LF>	"ZH" (ASCII characters); "123" represents wind direction (degrees from north)
ZI456<CR><LF>	"ZI" (ASCII characters); "456" represents wind speed (knots)
ZJ<+/->78<CR><LF>	"ZJ" (ASCII characters); sign; "78" represents rate of turn (degrees per second)
ZK<+/->901<CR><LF>	"ZK" (ASCII characters); sign; "901" represents vertical speed (tens of ft/minute)
ZL234<CR><LF>	"ZL" (ASCII characters); "234" represents heading (degrees from north)
ZM5678<CR><LF>†	"ZM" (ASCII characters); "5678" represents fuel flow, right (tenths gallons/hour)
ZN90123<CR><LF>†	"ZN" (ASCII characters); "90123" represents fuel used, right (tenths gallons)
ZO4567<CR><LF>†	"ZO" (ASCII characters); "4567" represents fuel flow, left (tenths gallons/hour)
ZP89012<CR><LF>†	"ZP" (ASCII characters); "89012" represents fuel used, left (tenths gallons)
ZQ345<CR><LF>	"ZQ" (ASCII characters); "345" represents error log/reason indicator
ZR678<CR><LF>	"ZR" (ASCII characters); "678" represents checksum

<ETX>

Where:

- <STX> start-transmit character (0x02)
- <CR> carriage-return character (0x0d)
- <LF> line-feed character (0x0a)
- <+/-> sign indicator (0x2b["+"] or 0x2d["-"])
- <ETX> end-transmit character (0x03)

† Not available from Airdata Computer

Note: Checksum is calculated by adding each byte in the message (including all characters from <STX> up to and including the error log/reason indicator), such that carries are discarded to give a one byte result. The ASCII-coded decimal representation of that byte is given, ranging from 0 (0x30, 0x30, 0x30) to 255 (0x32, 0x35, 0x35).

D.6.2 SHADIN "G" FORMAT

<STX>

GA012<CR><LF>	"GA" (ASCII characters); "012" represents indicated Air Speed (knots)
GB345<CR><LF>	"GB" (ASCII characters); "345" represents true Air Speed (knots)
GC678<CR><LF>	"GC" (ASCII characters); "678" represents Mach Speed (thousandths)
GD<+/->9012<CR><LF>	"GD" (ASCII characters); sign; "9012" represents pressure altitude (tens of feet)
GE<+/->3456<CR><LF>	"GE" (ASCII characters); sign; "3456" represents density altitude (tens of feet)
GF<+/->78<CR><LF>	"GF" (ASCII characters); sign; "78" represents outside air temperature (Celsius)
GG<+/->90<CR><LF>	"GG" (ASCII characters); sign; "90" represents true air temperature (Celsius)
GH123<CR><LF>	"GH" (ASCII characters); "123" represents wind direction (degrees from north)
GI456<CR><LF>	"GI" (ASCII characters); "456" represents wind speed (knots)
GJ<+/->78<CR><LF>	"GJ" (ASCII characters); sign; "78" represents rate of turn (degrees per second)
GK<+/->901<CR><LF>	"GK" (ASCII characters); sign; "901" represents vertical speed (tens of ft/minute)
GL234<CR><LF>	"GL" (ASCII characters); "234" represents heading (degrees from north)
GM5678<CR><LF>†	"GM" (ASCII characters); "5678" represents fuel flow, right (Twin only) (tenths gallons/hour)
GN90123<CR><LF>†	"GN" (ASCII characters); "90123" represents fuel used, right (Twin only) (tenths gallons)
GO4567<CR><LF>	"GO" (ASCII characters); "4567" represents fuel flow, left (or Single) (tenths gallons/hour)
GP89012<CR><LF>	"GP" (ASCII characters); "89012" represents fuel used, left (or Single) (tenths gallons)
GQ001<CR><LF>	"GQ" (ASCII characters); "001" represents error log/reason indicator (001 = temp. sensor error, 000 = no errors)
GR6789.0<CR><LF>†	"GR" (ASCII characters); "6789.0" represents fuel remaining (gallons)
Ga<+/->1234<CR><LF>	"Ga" (ASCII characters); sign; "12.34" represents barometric corrected altitude (tens of feet)
Gb56.78<CR><LF>	"Gb" (ASCII characters); "56.78" represents current barometric pressure setting (inches Hg)
G*901<CR><LF>	"G*" (ASCII characters); "901" represents checksum

<ETX>

Where:

- <STX> start-transmit character (0x02)
- <CR> carriage-return character (0x0d)
- <LF> line-feed character (0x0a)
- <+/-> sign indicator (0x2b["+"] or 0x2d["-"])
- <ETX> end-transmit character (0x03)

† Not available from Airdata Computer

Note: Checksum is calculated by adding each byte in the message (including all characters from <STX> up to and including the error log/reason indicator), such that carries are discarded to give a one byte result. The ASCII-coded decimal representation of that byte is given, ranging from 0 (0x30, 0x30, 0x30) to 255 (0x32, 0x35, 0x35).

D.6.3 SHADIN "S" FORMAT

<STX>

SA012<CR><LF>	"SA" (ASCII characters); "012" represents indicated Air Speed (knots)
SB345<CR><LF>	"SB" (ASCII characters); "345" represents true Air Speed (knots)
SC678<CR><LF>	"SC" (ASCII characters); "678" represents Mach Speed (thousandths)
SD<+/->9012<CR><LF>	"SD" (ASCII characters); sign; "9012" represents pressure altitude (tens of feet)
SE<+/->3456<CR><LF>	"SE" (ASCII characters); sign; "3456" represents density altitude (tens of feet)
SF<+/->78<CR><LF>	"SF" (ASCII characters); sign; "78" represents outside air temperature (Celsius)
SG<+/->90<CR><LF>	"SG" (ASCII characters); sign; "90" represents true air temperature (Celsius)
SH123<CR><LF>	"SH" (ASCII characters); "123" represents wind direction (degrees from north)
SI456<CR><LF>	"SI" (ASCII characters); "456" represents wind speed (knots)
SJ<+/->78<CR><LF>	"SJ" (ASCII characters); sign; "78" represents rate of turn (degrees per second)
SK<+/->901<CR><LF>	"SK" (ASCII characters); sign; "901" represents vertical speed (tens of ft/minute)
SL234<CR><LF>	"SL" (ASCII characters); "234" represents heading (degrees from north)
SM5678<CR><LF>	"SM" (ASCII characters); "5678" represents fuel flow, right (tenths gallons/hour)
SN90123<CR><LF>	"SN" (ASCII characters); "90123" represents fuel used, right (tenths gallons)
SO4567<CR><LF>	"SO" (ASCII characters); "4567" represents fuel flow, left (tenths gallons/hour)
SP89012<CR><LF>	"SP" (ASCII characters); "89012" represents fuel used, left (tenths gallons)
SQ345<CR><LF>	"SQ" (ASCII characters); "345" represents error log/reason indicator
SR67890<CR><LF>	"SR" (ASCII characters); "67890" represents fuel remaining (tenths gallons)
SS123<CR><LF>	"SS" (ASCII character); "123" represents ground speed (knots)
ST456<CR><LF>	"ST" (ASCII character); "456" represents track (degrees)
SU789012<CR><LF>	"SU" (ASCII character); "789012" represents distance to waypoint (hundredths nautical miles)
SV<E/W>345<CR><LF>	"SV" (ASCII character); "E" represents East, "W" represents West; "345" represents magnetic variation (tenths degrees)
SW<N/S>67 8901<CR><LF>	"SW" (ASCII character); "N" represents North, "S" represents South; "67 8910" represents current latitude (degrees, minutes, hundredths of minutes)
SX<E/W>234 5678<CR><LF>	"SX" (ASCII character); "E" represents East, "W" represents West; "234 5678" represents current longitude (degrees, minutes, hundredths of minutes)
SY<L/R>90<CR><LF>	"SY" (ASCII character); "L" represents Left, "R" represents Right; "90" represents drift angle (degrees)
Sa<+/->1234<CR><LF>	"Sa" (ASCII character); sign; "1234" represents barometric corrected altitude (tens of feet)
Sb56.78<CR><LF>	"Sb" (ASCII character); "56.78" represents current barometric pressure setting (inches Hg)
S*901<CR><LF>	"S*" (ASCII character); "901" represents checksum

<ETX>

Where:

- <STX> start-transmit character (0x02)
- <CR> carriage-return character (0x0d)
- <LF> line-feed character (0x0a)
- <+/-> sign indicator (0x2b["+"] or 0x2d["-"])
- <ETX> end-transmit character (0x03)

Note: Checksum is calculated by adding each byte in the message (including all characters from <STX> up to and including the error log/reason indicator), such that carries are discarded to give a one byte result. The ASCII-coded decimal representation of that byte is given, ranging from 0 (0x30, 0x30, 0x30) to 255 (0x32, 0x35, 0x35).

Appendix E. 500 SERIES LRU INTERFACE OVERVIEW

The following tables provide a quick overview of some of the equipment that can be interfaced with the Garmin 500 Series units. This is not a complete listing however; it only represents those units listed in Appendix F of this manual. When installing equipment on the aircraft always refer to the manufacturers' documentation for complete pinout and interconnect information.

E.1 GARMIN 530 LRU INTERFACE

Function	Bendix/King	Garmin	PS Engineering
Audio Panel	KMA 24	GMA 340	PMA 6000
	KMA 24H		
	-70/-71		

E.2 GARMIN 500/530 LRU INTERFACE

Function	Bendix/King	B & D
Air Data Computer	KDC 281	2600
	KDC 481	2601
		2800
		90004-003

Function	Shadin	Icarus Instruments	ARNAV	JP Instruments	Shadin Miniflo-L
Altitude Serializer or Fuel/Air Data	8800T	3000	FC-10	EDM-700	91204XT(38)D
	9000T		FT-10		
	9200T				

Function	Shadin Digiflo-L	Shadin Digidata	Shadin	Electronics International
Altitude Serializer or Fuel/Air Data	91053XP	91802(-)	F/ADC-200	FP-5L
	91053XT-D		F/ADC-2000	

Function	Bendix/King	S-Tec
Autopilot	KFC 150	System 55
Flight Control	KFC 200	
	KFC 400	
	KCP 420	

Function	Bendix/King	Terra	Shadin
Encoding Altimeter Or Blind Encoder	KEA-130A	AT-3000	Miniflo-L
	KEA-346		Digiflo-L
			Digidata

Function	Bendix/King	Collins
EFIS	EFIS 40/50	EFIS-84
Displays	SG 465	DPU-84

Function	Sandel
EHSI	SN 3308

Function	Bendix/King	Collins	Honeywell	Litef	Litton
IRU/AHRS	KAU 461	AHC 85E	Laseref	LTR 81	LTN 90-100
			HG 1075 AB		LTN-91
			HG 1095 AB		LTN-92

Function	Bendix/King	Garmin	Century	Collins	Sperry	S-Tec
Nav	KI 202A	GI 102/A	NSD 360A	331A-6P	RD 550A	ST 180
Indicator	KI 203	GI 106/A	NSD 1000	331A-6G	RD 650	
	KI 204					
	KI 206					
	KI 208/A					
	KI 209/A					
	KI 525A					
	KPI 522/B					
	KPI 553/A/B					

Function	Bendix/King	BF Goodrich	Ryan	Garmin
Weather, Traffic and Terrain	KTA 870	SKY497 (Skywatch)	9900B/BX	GTX 330
	KMH 880	SKY899 (Skywatch HP)		
		WX-500		

Appendix F. DRAWINGS AND INTERCONNECTS

F.1 INTRODUCTION

This section contains installation drawings to aid in the installation of a GPS 500 family unit. Additional information and notes included on the drawings can be used as reference information during installation.

F.2 DRAWING LIST

The following drawings are included in this section:

- ❑ Figure F-1—GA 56 Antenna Installation Drawing
- ❑ Figure F-2—GNS 530 Mounting Rack Dimensions
- ❑ Figure F-3—GPS 500 Mounting Rack Dimensions
- ❑ Figure F-4—GNS 530 Mounting Rack Installation
- ❑ Figure F-5—GPS 500 Mounting Rack Installation
- ❑ Figure F-6—500 Series Recommended Panel Cutout Dimensions
- ❑ Figure F-7—500 Series System Interface Diagram
- ❑ Figure F-8—GNS 530/(A) Typical Installation
- ❑ Figure F-9—GPS 500 Typical Installation
- ❑ Figure F-10—Power, Lighting, and Antennas Interconnect
- ❑ Figure F-11—Altimeter Interconnect
- ❑ Figure F-12—Main Indicator Interconnect
- ❑ Figure F-13—KI 209A Main Indicator Interconnect
- ❑ Figure F-14—KI 208A Main Indicator Interconnect
- ❑ Figure F-15—Annunciators/Switches Interconnect
- ❑ Figure F-16—RS-232 Serial Data Interconnect
- ❑ Figure F-17—ARINC 429 EFIS Interconnect
- ❑ Figure F-18—ARINC 429 Sandel EHSI Interconnect (1 500 Series Unit, 1 Sandel SN3308)
- ❑ Figure F-19—ARINC 429 Sandel EHSI Interconnect (2 GNS 530, 1 Sandel SN3308)
- ❑ Figure F-20—ARINC 429 Sandel EHSI Interconnect (2 GNS 530, 2 Sandel SN3308)
- ❑ Figure F-21—ARINC 429/RS 232 Air Data/IRU/AHRS Interconnect
- ❑ Figure F-22—ARINC 429 Flight Control Interconnect
- ❑ Figure F-23—Traffic Advisory System Interconnect
- ❑ Figure F-24—GTX 330 Interconnect
- ❑ Figure F-25—Weather and Terrain Interconnect
- ❑ Figure F-26—Audio Panel Interconnect
- ❑ Figure F-27—VOR/ILS Indicator Interconnect
- ❑ Figure F-28—RMI/OBI Interconnect

-
- Figure F-29—King Serial Panel DME Tuning Interconnect
 - Figure F-30—King Serial Remote DME Tuning Interconnect
 - Figure F-31—Parallel 2 OF 5 DME Tuning Interconnect
 - Figure F-32—Parallel BCD/Slip Code DME Tuning Interconnect

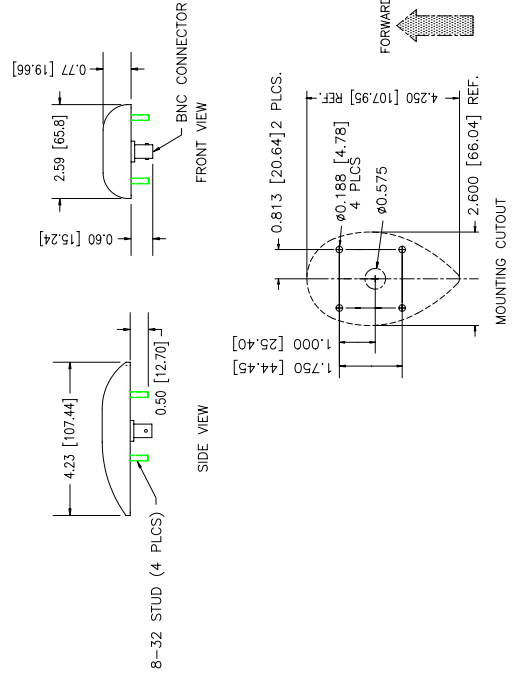
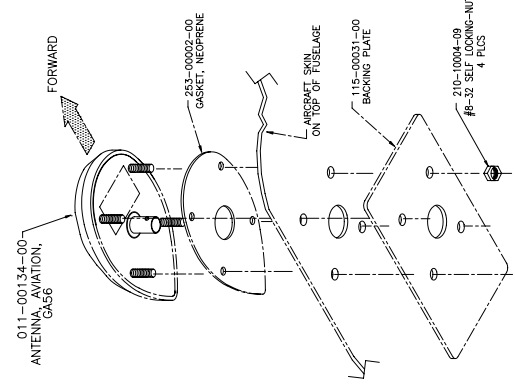
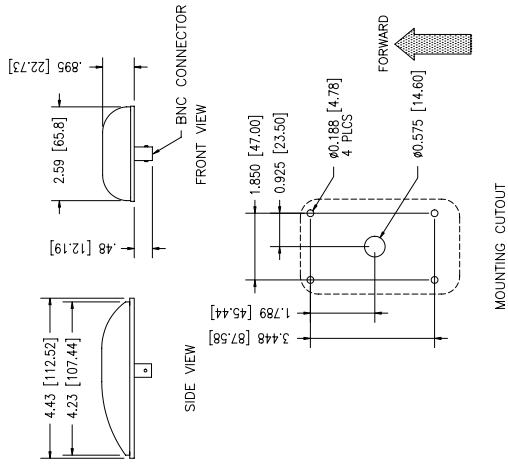
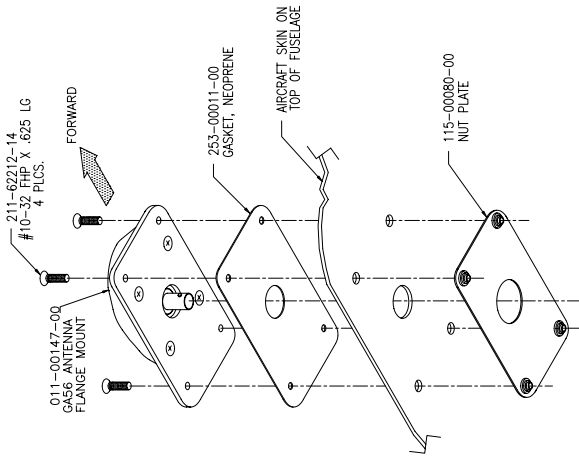
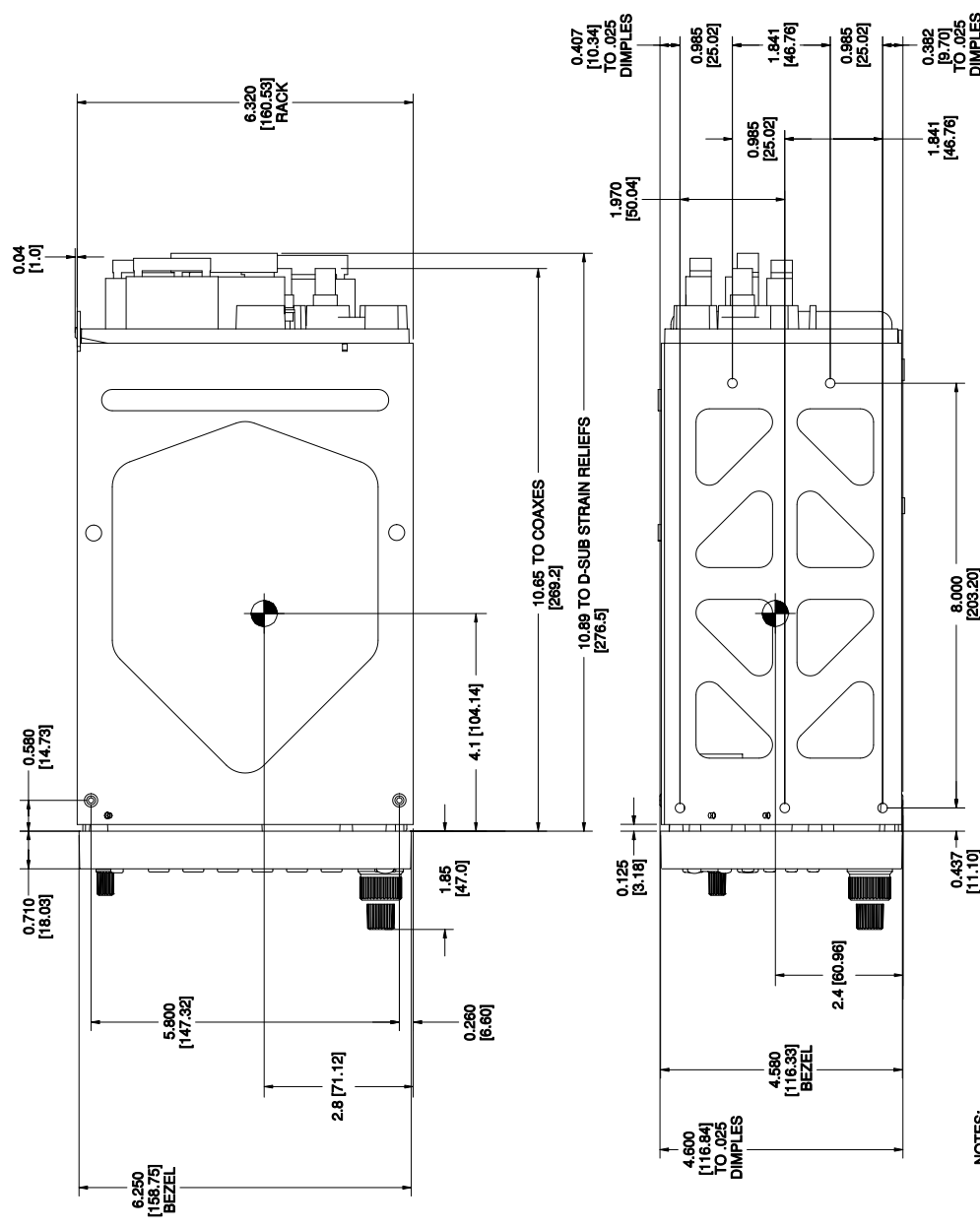
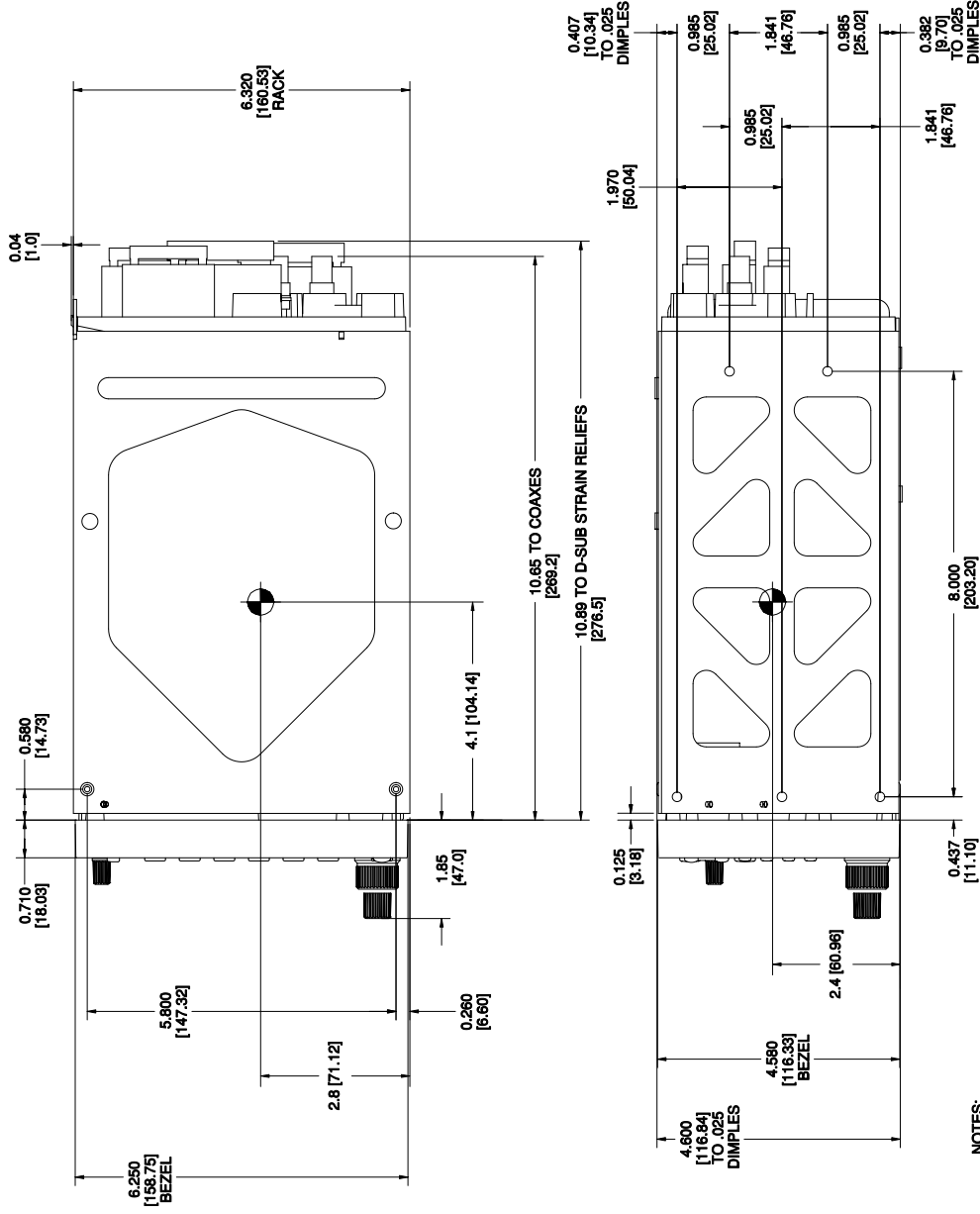

Figure F-1. GA 56 Antenna Installation Drawing



- NOTES:
1. DIMENSIONS: INCH (mm).
 2. GPS 500 UNIT ONLY WEIGHT: 5.7 LBS (2.6 KGS).
INSTALLED WITH RACK AND CONNECTORS WEIGHT: 7.2 LBS (3.3 KGS).
VIDEO CARD CONNECTOR KIT WEIGHT (011-006588-00): 0.11 LBS (0.05 KGS)
 3. CG LOCATION INCLUDES RADIO ONLY.

Figure F-2. GNS 530 Mounting Rack Dimensions



- NOTES:
1. DIMENSIONS: INCH (mm).
 2. GPS 500 UNIT ONLY WEIGHT: 5.7 LBS (2.6 KGS).
INSTALLED WITH RACK AND CONNECTORS WEIGHT: 7.2 LBS (3.3 KGS).
VIDEO CARD CONNECTOR KIT WEIGHT (011-00558-00): 0.11 LBS (0.05 KGS)
 4. CG LOCATION INCLUDES RADIO ONLY.

Figure F-3. GPS 500 Mounting Rack Dimensions

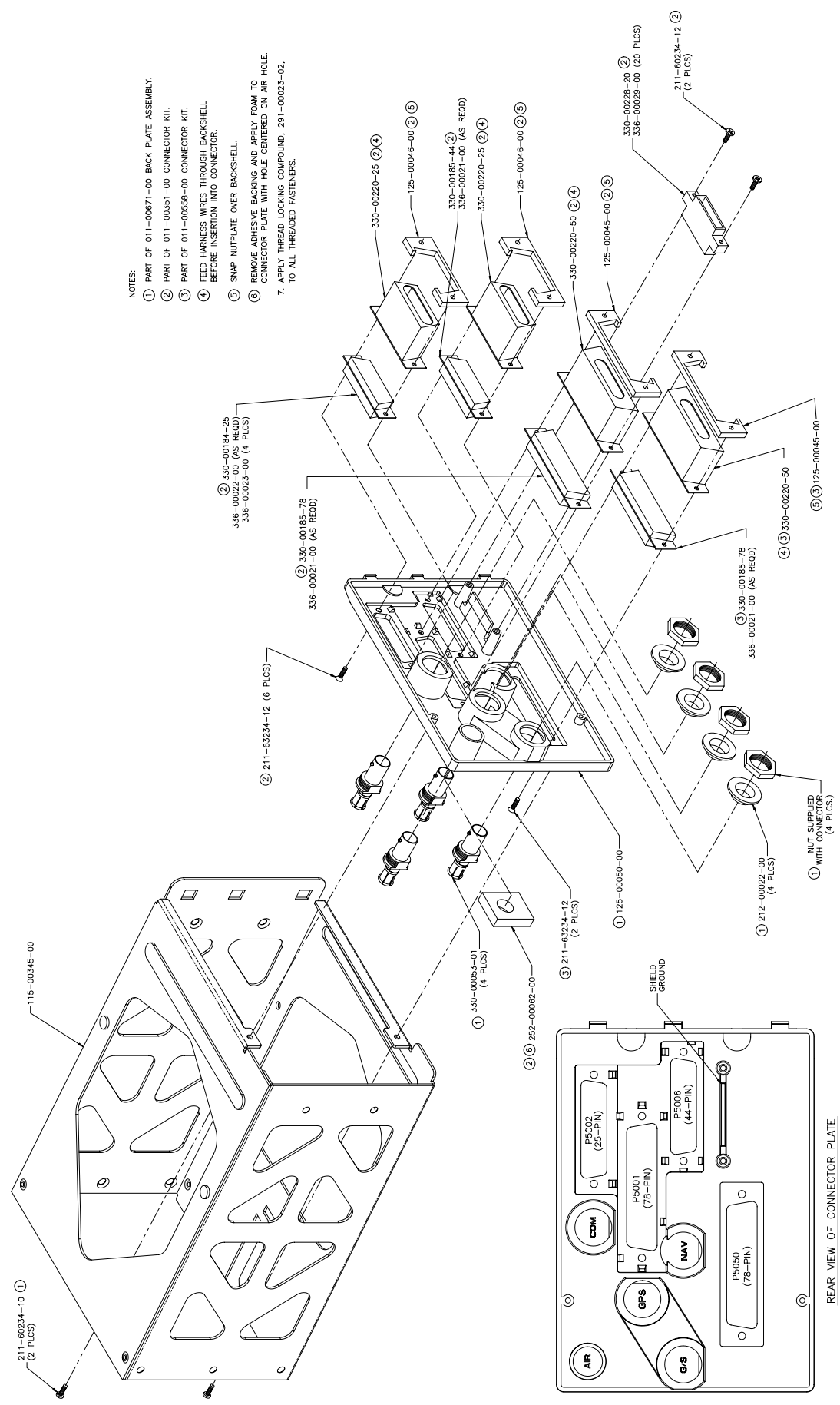

- NOTES:
- ① PART OF 011-00671-00 BACK PLATE ASSEMBLY.
 - ② PART OF 011-00351-00 CONNECTOR KIT.
 - ③ PART OF 011-00558-00 CONNECTOR KIT.
 - ④ FEED HARNESS WIRES THROUGH BACKSHELL BEFORE INSERTION INTO CONNECTOR.
 - ⑤ SNAP NUT/PLATE OVER BACKSHELL.
 - ⑥ REMOVE ADHESIVE BACKING AND APPLY FOAM TO CONNECTOR PLATE WITH HOLE CENTERED ON AIR HOLE.
 - ⑦ APPLY THREAD LOCKING COMPOUND, 291-00023-02, TO ALL THREADED FASTENERS.

Figure F-4. GNS 530 Mounting Rack Installation

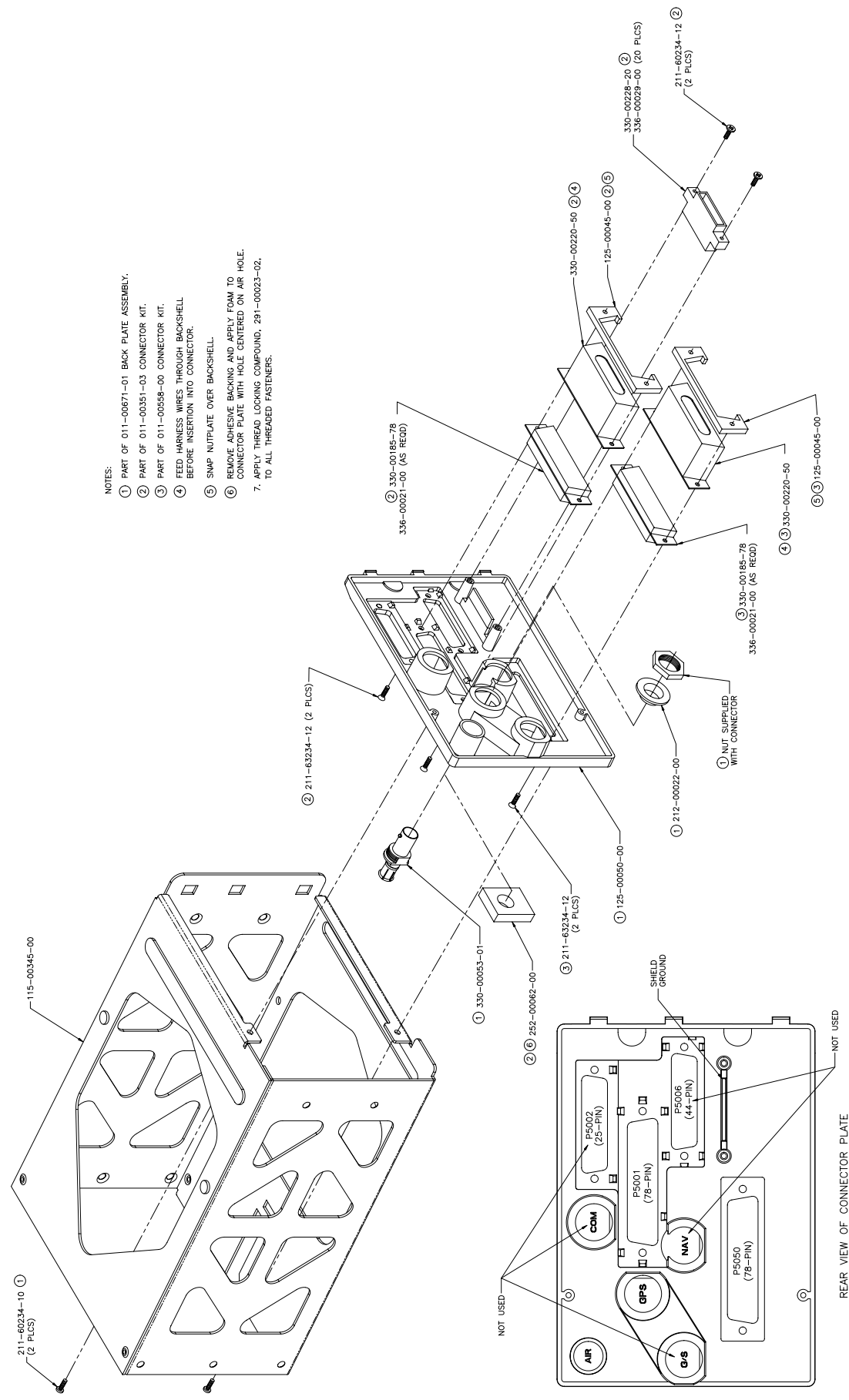
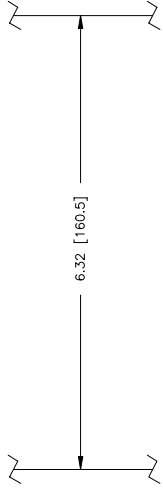
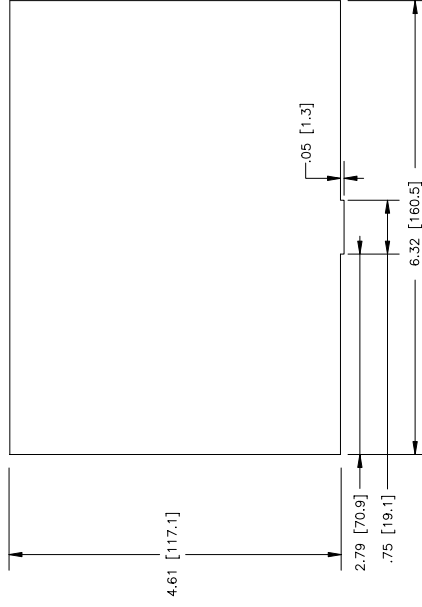

Figure F-5. GPS 500 Mounting Rack Assembly

OPTION 1:
 STACK CUTOUT (RACK INSTALLED
 FROM FRONT OF AIRCRAFT PANEL)



OPTION 2:
 RADIO CUTOUT (RACK INSTALLED
 FROM FRONT OF AIRCRAFT PANEL)



OPTION 3:
 RADIO CUTOUT (RACK INSTALLED
 FROM BACK OF AIRCRAFT PANEL ONLY)
 MAXIMUM AIRCRAFT PANEL THICKNESS
 IS .125 INCH [3.2 mm]

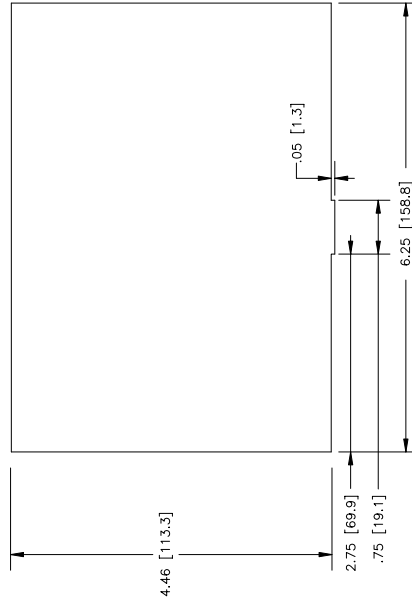

- NOTES:
1. DIMENSIONS: INCH [mm].
 2. IF THE FRONT LIP OF THE MOUNTING RACK IS BEHIND THE SURFACE OF THE AIRCRAFT PANEL, THE 500 SERIES UNIT CONNECTORS MAY NOT FULLY ENGAGE.

Figure F-6. 500 Series Recommended Panel Cutout Dimensions

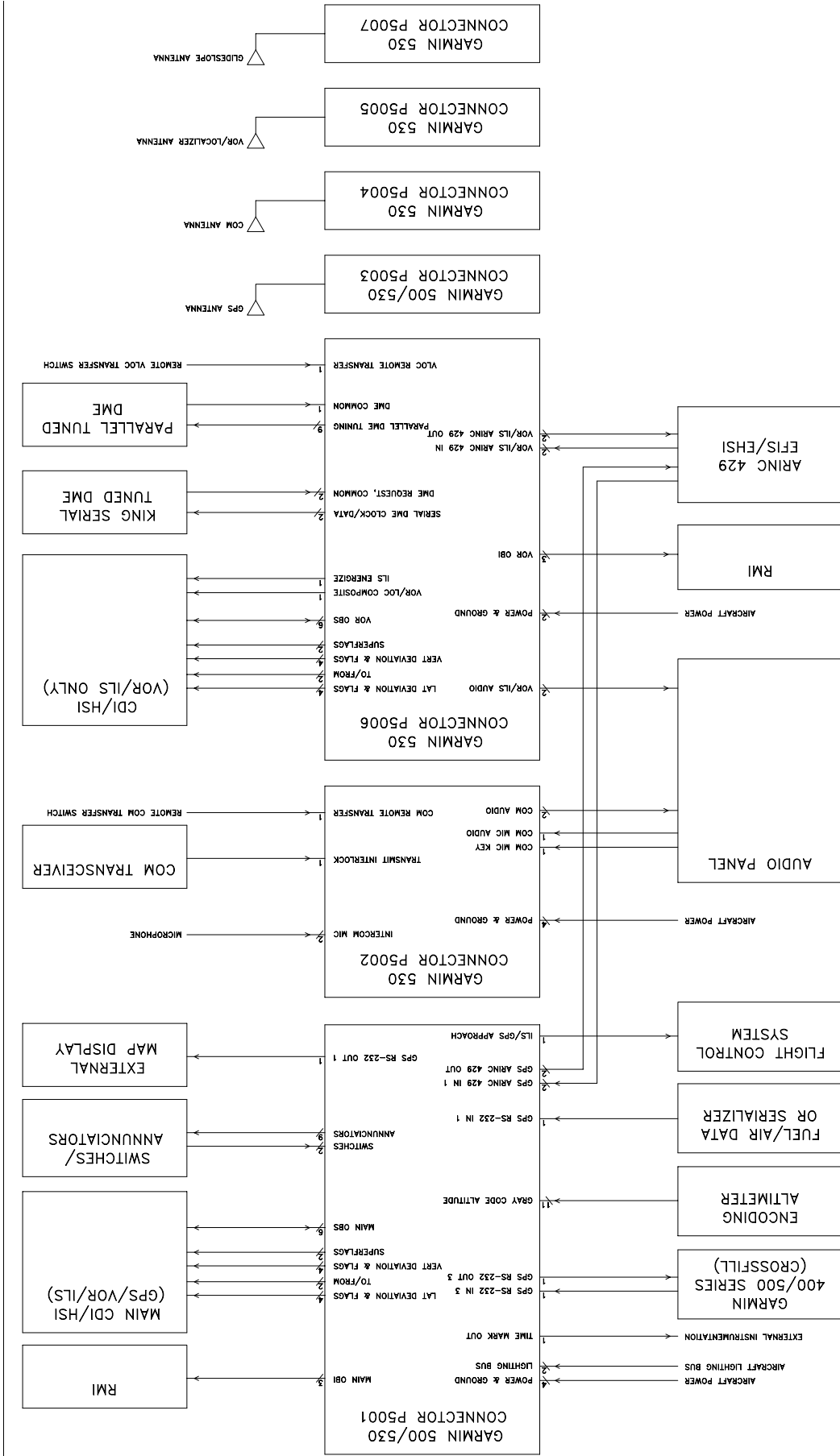

Figure F-7. 500 Series System Interface Diagram

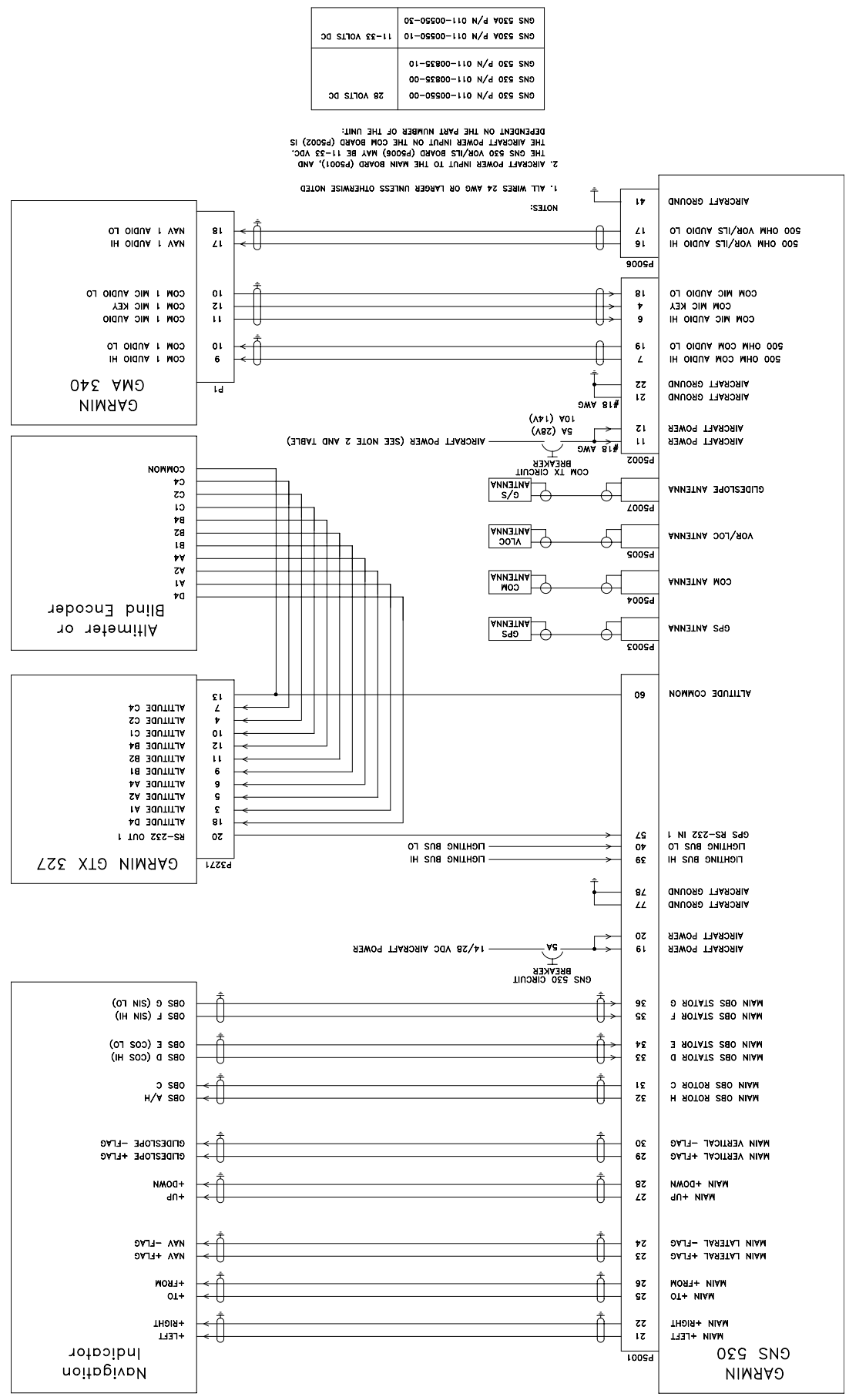
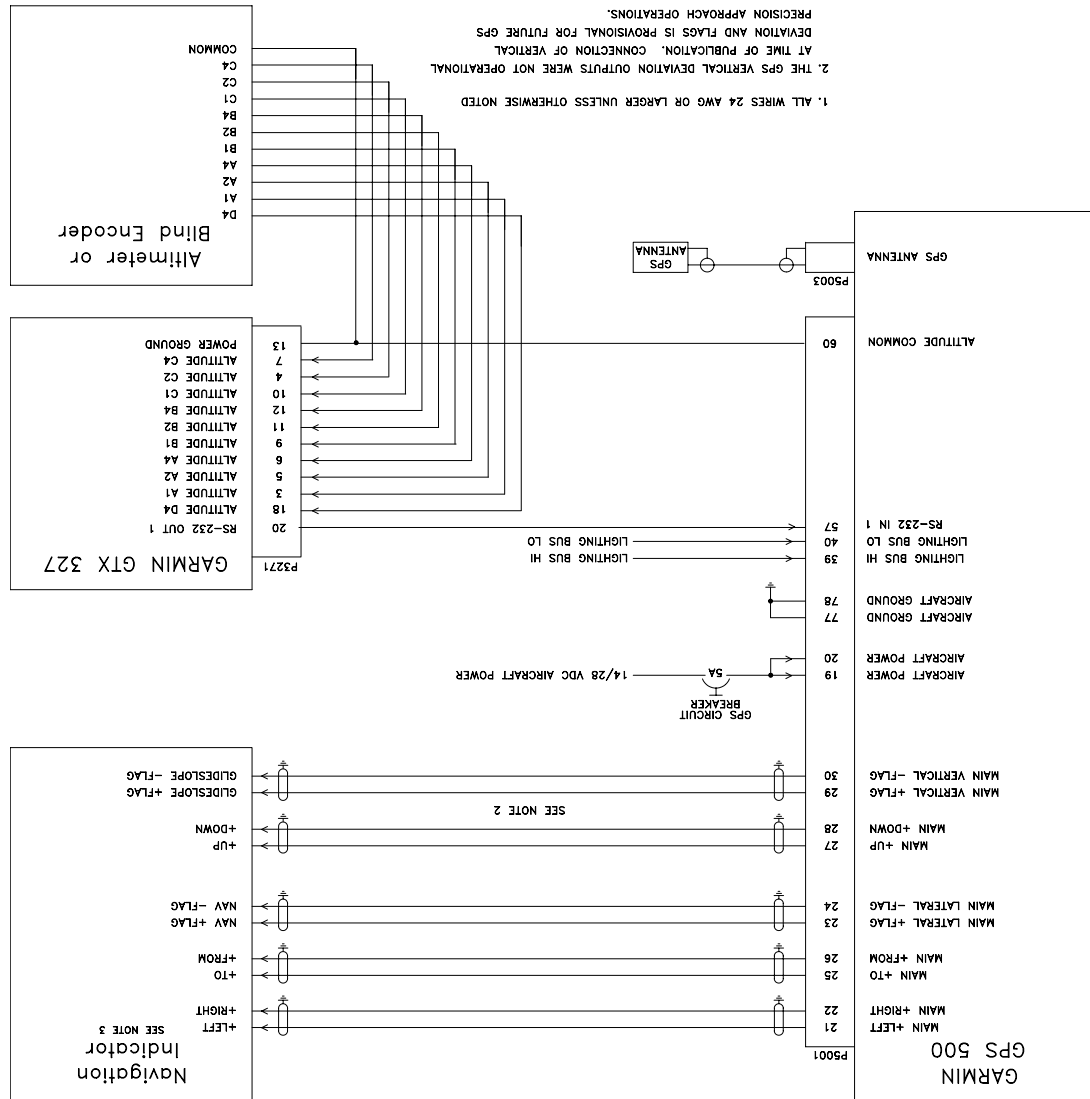
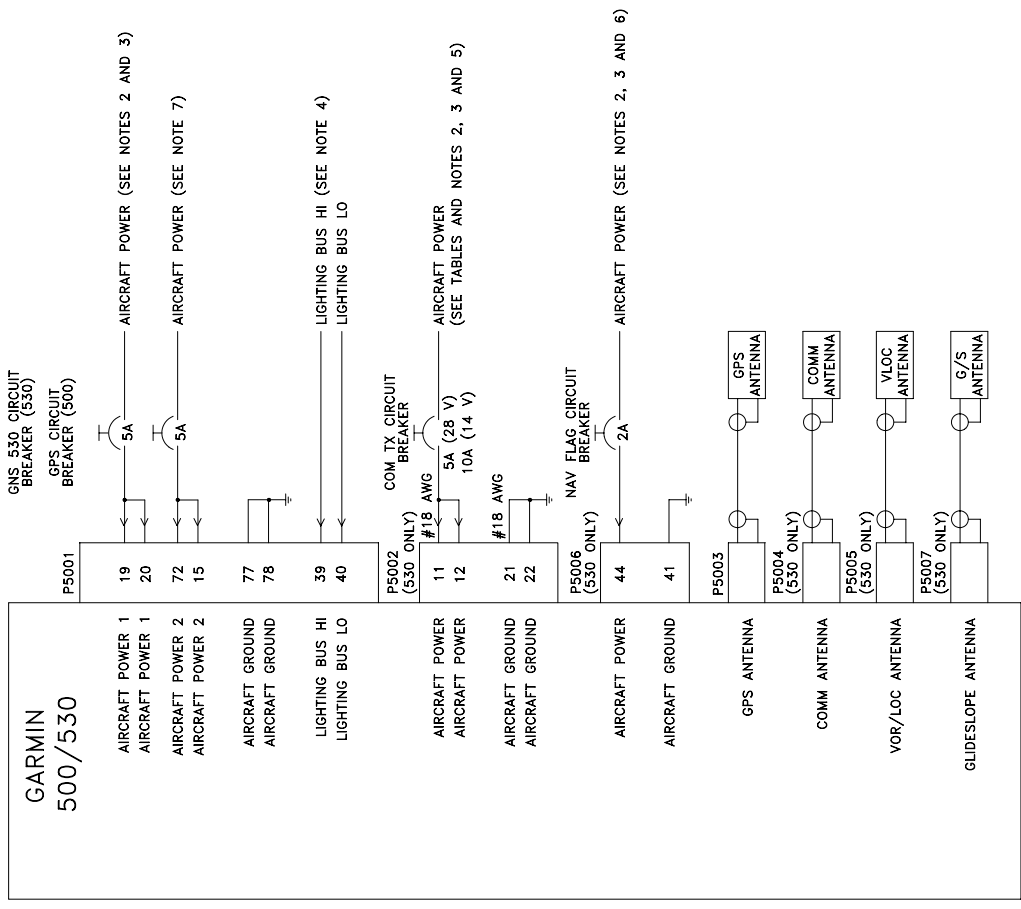

Figure F-8. GNS 530(A) Typical Installation



1. ALL WIRES 24 AWG OR LARGER UNLESS OTHERWISE NOTED
2. THE GPS VERTICAL DEVIATION OUTPUTS WERE NOT OPERATIONAL AT TIME OF PUBLICATION. CONNECTION OF VERTICAL DEVIATION AND FLAGS IS PROVISIONAL FOR FUTURE GPS PRECISION APPROACH OPERATIONS.
3. IF OBS CONNECTIONS ARE NOT MADE TO THE GPS 500, THEN ALL OBS COURSE SELECTIONS WILL NEED TO BE MADE USING THE GPS 500 KNOBS. IF AN OBS INTERFACE IS DESIRED, REFER TO THE APPROPRIATE MAIN INDICATOR INTERCONNECT DRAWING.

Figure F-9. GPS 500 Typical Installation
 Page F-19 (Page F-20 blank)
 Rev J



NOTES:

- ALL WIRES 24 AWG OR LARGER UNLESS OTHERWISE NOTED
 - IF THE AIRCRAFT HAS MULTIPLE AIRCRAFT POWER BUSES, IT IS RECOMMENDED THAT ALL GNS 530 POWER INPUTS BE CONNECTED TO THE SAME POWER BUS.
THE FOLLOWING TABLE SHOWS WHAT GNS 530 FUNCTIONS DEPEND ON WHICH POWER INPUTS:
- | | |
|-------|---|
| P5001 | ALL GNS 530 FUNCTIONS DEPEND ON THIS POWER INPUT. |
| P5002 | COM TRANSMITTER |
| P5006 | NAV SUPERFLAG, GLIDESLOPE SUPERFLAG |
- AIRCRAFT POWER INPUT TO THE MAIN BOARD (P5001), AND THE GNS 530 VOR/LS BOARD (P5006) MAY BE 11-33 VDC. THE AIRCRAFT POWER INPUT ON THE COM BOARD (P5002) IS DEPENDENT ON THE PART NUMBER OF THE UNIT:
- | | |
|---------------------------|----------------|
| GNS 530 P/N 011-00550-00 | 28 VOLTS DC |
| GNS 530A P/N 011-00835-00 | |
| GNS 530A P/N 011-00835-10 | |
| GNS 530 P/N 011-00550-10 | 11-33 VOLTS DC |
| GNS 530 P/N 011-00550-30 | |
- THE 500 SERIES UNIT SHOULD BE CONFIGURED FOR THE CORRECT LIGHTING BUS VOLTAGE (28 VDC, 14 VDC, 5 VDC OR 5 VAC) POST-INSTALLATION. NO DAMAGE WILL OCCUR IF THE UNIT IS CONFIGURED INCORRECTLY. IN ADDITION, LIGHTING CAN BE SET TO AUTOMATICALLY COMPENSATE FOR AMBIENT LIGHTING CONDITIONS USING ITS PHOTOCELL. A MANUAL LIGHTING CONTROL OPTION IS ALSO AVAILABLE. REFER TO THE POST-INSTALLATION CONFIGURATION PROCEDURE.
 - MAXIMUM ALLOWABLE WIRE GAUGE INTO P5002 PINS IS #22 AWG. FOR #18 AWG WIRE USE SPECIAL #18 AWG TERMINATION SOCKET CONTACT (336-00023-00) SUPPLIED WITH CONNECTOR KIT. PROTECT EXPOSED CONDUCTOR ON SPECIAL LARGE TERMINATION CONTACTS WITH 3/8" (1 cm) LENGTH OF SHRINK TUBING ALSO SUPPLIED WITH CONNECTOR KIT.
 - THE AIRCRAFT POWER INPUT P5006-44 PROVIDES POWER FOR THE VOR/LOC SUPERFLAG (P4006-15) AND GLIDESLOPE SUPERFLAG (P5006-38) OUTPUTS. NO POWER CONNECTION IS REQUIRED ON P5006-44 IF THESE FLAG OUTPUTS ARE NOT USED.
 - OPTIONAL ALTERNATE POWER, APPLIES ONLY TO PART NUMBERS 011-00550-30 AND 011-00835-10 (GNS 530/A, AND 011-00562-10 (GPS 500).

Figure F-10. Power, Lighting, and Antennas Interconnect

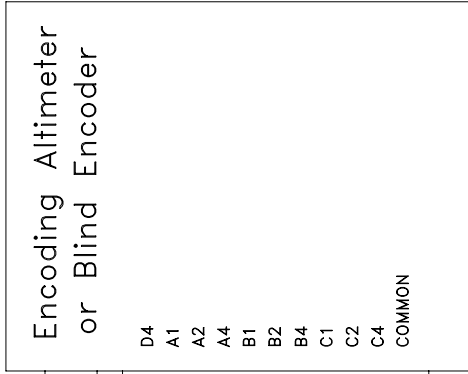
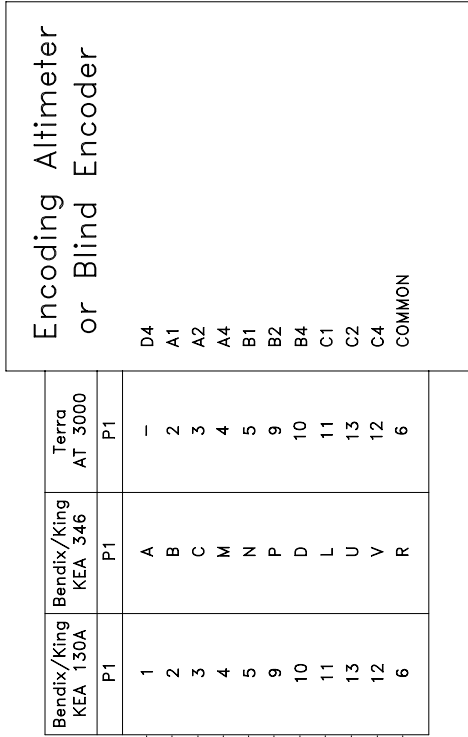
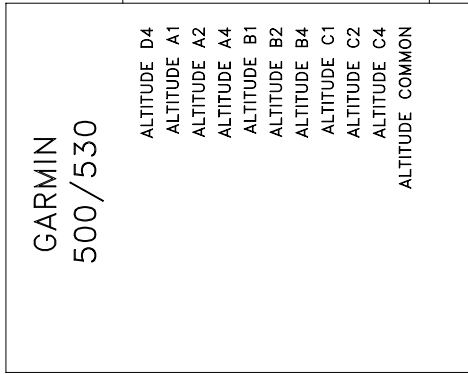

- NOTES:
1. ALL WIRES 24 AWG OR LARGER UNLESS OTHERWISE NOTED
 2. REFER TO MANUFACTURERS' DOCUMENTATION FOR COMPLETE PINOUT AND INTERCONNECT INFORMATION. PINOUTS OF OTHER UNITS SHOWN FOR REFERENCE ONLY.

Figure F-11. Altimeter Interconnect

GARMIN 500/530		Navigation Indicator											
P5001	GARMIN GI 102 GI 102A	GARMIN GI 106	GARMIN GI 106A	S-Tec ST 180	Bendix/King KI 206		Century NSD1000 KPI 553/A/B	Collins S31A-6P		Sperry RD 550A		Sperry RD 650	
					P1	P2		P1	P2	P1	P2		P1
21	11	11	11	27	V		17	29	4	F	4	+LEFT	
22	12	12	12	43	B		18	28	3	E	3	+RIGHT	
25	9	9	9	26	Z		33	26	1	A	1	+TO	
26	10	10	10	42	T		34	27	2	B	2	+FROM	
23	7	7	7	37	N		31	31	-	-	-	NAV +FLAG	
24	8	8	8	38	F		32	32	-	-	-	NAV -FLAG	
17	-	-	-	-	-		-	-	37	P	39	NAV SUPERFLAG	
	-	-	-	-	-		-	-	38	S	36	NAV SUPERFLAG LO	
27	-	13	13	44	K		27	33	5	C	5	+UP	
28	-	14	14	28	M		28	34	6	D	6	+DOWN	
29	-	15	15	36	H		30	35	-	-	-	GLIDESLOPE +FLAG	
30	-	16	16	35	J		29	36	-	-	-	GLIDESLOPE -FLAG	
18	-	-	-	-	-		-	-	7	U	38	GLIDESLOPE SUPERFLAG	
	-	-	-	-	-		-	-	-	W	8	GLIDESLOPE SUPERFLAG LO	
32	1	1	1	22	C		15	1	1	DD	6	OBS A/H	
31	2	2	2	24	Z		16	3	3	FF	8	OBS C	
33	3	3	3	25	L		24	4	4	Z	9	OBS D (COS HI)	
34	5	5	5	39	P		23	5	5	AA	10	OBS E (COS LO)	
35	4	4	4	40	T		26	6	6	BB	11	OBS F (SIN HI)	
36	6	6	6	41	W		25	7	7	CC	12	OBS G (SIN LO)	
2	-	N/C	-	-	-		-	-	-	-	-	GPS ANNUNCIATOR	
	-	N/C	-	-	-		-	-	-	-	-	VLOC ANNUNCIATOR	

NOTES:

1. ALL WIRES 24 AWG OR LARGER UNLESS OTHERWISE NOTED
2. P5001-2 (GPS ANNUNCIATE) AND P5001-1 (VLOC ANNUNCIATE) DO NOT APPLY TO GPS 500.
3. LOWER CASE PIN DESIGNATORS ARE SHOWN AS UNDERLINED UPPER CASE LETTERS.
4. REFER TO MANUFACTURERS' DOCUMENTATION FOR COMPLETE PINOUT AND INTERCONNECT INFORMATION. PINOUTS OF OTHER UNITS SHOWN FOR REFERENCE ONLY.
5. DASHED ELIPSE INDICATES CHANGED CONTENT.

Figure F-12. Main Indicator Interconnect

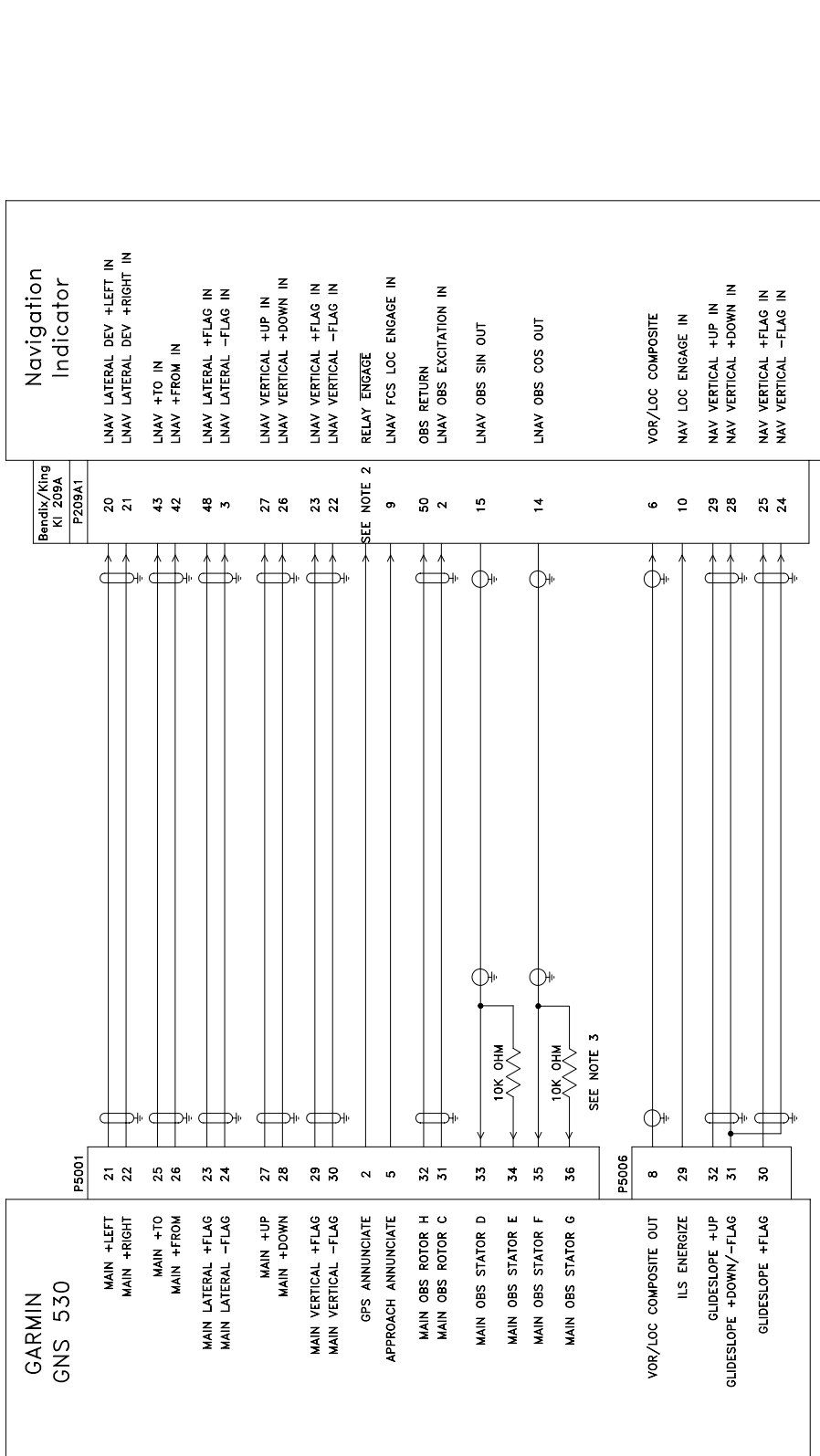

- NOTES:
1. ALL WIRES 24 AWG OR LARGER UNLESS OTHERWISE NOTED
 2. PROPER CONNECTION OF THE RELAY ENGAGE INPUT OF THE KI 209A IS DEPENDENT ON ITS POWER SUPPLY VOLTAGE. REFER TO KI 209A DOCUMENTATION FOR PROPER CONNECTION.
 3. TO CONNECT THE GNS 530 TO A KI 209A INDICATOR, ADD TWO 10 KOHM, 1/4 WATT RESISTORS. ONE BETWEEN P5001 PINS 33 AND 34, AND ONE BETWEEN P5001 PINS 35 AND 36.

4. REFER TO MANUFACTURERS' DOCUMENTATION FOR COMPLETE PINOUT AND INTERCONNECT INFORMATION. PINOUTS OF OTHER UNITS SHOWN FOR REFERENCE ONLY.

Navigation Indicator	
20	LNAV LATERAL DEV +LEFT IN
21	LNAV LATERAL DEV +RIGHT IN
43	LNAV +TO IN
42	LNAV +FROM IN
48	LNAV LATERAL +FLAG IN
3	LNAV LATERAL -FLAG IN
27	LNAV VERTICAL +UP IN
26	LNAV VERTICAL +DOWN IN
23	LNAV VERTICAL +FLAG IN
22	LNAV VERTICAL -FLAG IN
RELAY ENGAGE	
9	LNAV FCS LOC ENGAGE IN
50	OBS RETURN
2	LNAV OBS EXCITATION IN
15	LNAV OBS SIN OUT
14	LNAV OBS COS OUT
VOR/LOC COMPOSITE	
6	VOR/LOC COMPOSITE
10	NAV LOC ENGAGE IN
29	NAV VERTICAL +UP IN
28	NAV VERTICAL +DOWN IN
25	NAV VERTICAL +FLAG IN
24	NAV VERTICAL -FLAG IN

Figure F-13. KI 209A Main Indicator Interconnect

GARMIN GPS 500

P5001

- 21 MAIN +LEFT
- 22 MAIN +RIGHT
- 25 MAIN +TO
- 26 MAIN +FROM
- 23 MAIN LATERAL +FLAG
- 24 MAIN LATERAL -FLAG
- 5 APPROACH ANNUNCIATE
- 32 MAIN OBS ROTOR H
- 31 MAIN OBS ROTOR C
- 33 MAIN OBS STATOR D
- 34 MAIN OBS STATOR E
- 35 MAIN OBS STATOR F
- 36 MAIN OBS STATOR G

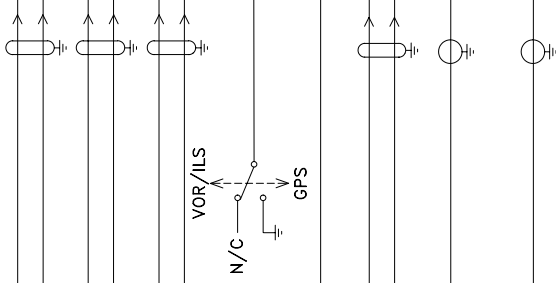

Navigation Indicator

Bendix/King
KI 208A
P208A1

- 20 LNAV LATERAL DEV +LEFT IN
- 21 LNAV LATERAL DEV +RIGHT IN
- 43 LNAV +TO IN
- 42 LNAV +FROM IN
- 48 LNAV LATERAL +FLAG IN
- 3 LNAV LATERAL -FLAG IN
- SEE NOTE 2 RELAY ENGAGE
- 9 LNAV FCS LOC ENGAGE IN
- 50 OBS RETURN
- 2 LNAV OBS EXCITATION IN
- 15 LNAV OBS SIN OUT
- 14 LNAV OBS COS OUT

NOTES:

1. ALL WIRES 24 AWG OR LARGER UNLESS OTHERWISE NOTED
2. PROPER CONNECTION OF THE RELAY ENGAGE INPUT OF THE KI 208A IS DEPENDENT ON ITS POWER SUPPLY VOLTAGE. REFER TO KI 208A DOCUMENTATION FOR PROPER CONNECTION.
3. TO CONNECT THE 500 SERIES UNIT TO A KI 208A INDICATOR, ADD TWO 10 KOHM, 1/4 WATT RESISTORS. ONE BETWEEN P5001 PINS 33 AND 34, AND ONE BETWEEN P5001 PINS 35 AND 36.
4. REFER TO MANUFACTURERS' DOCUMENTATION FOR COMPLETE PINOUT AND INTERCONNECT INFORMATION. PINOUTS OF OTHER UNITS SHOWN FOR REFERENCE ONLY.

Figure F-14. KI 208A Main Indicator Interconnect

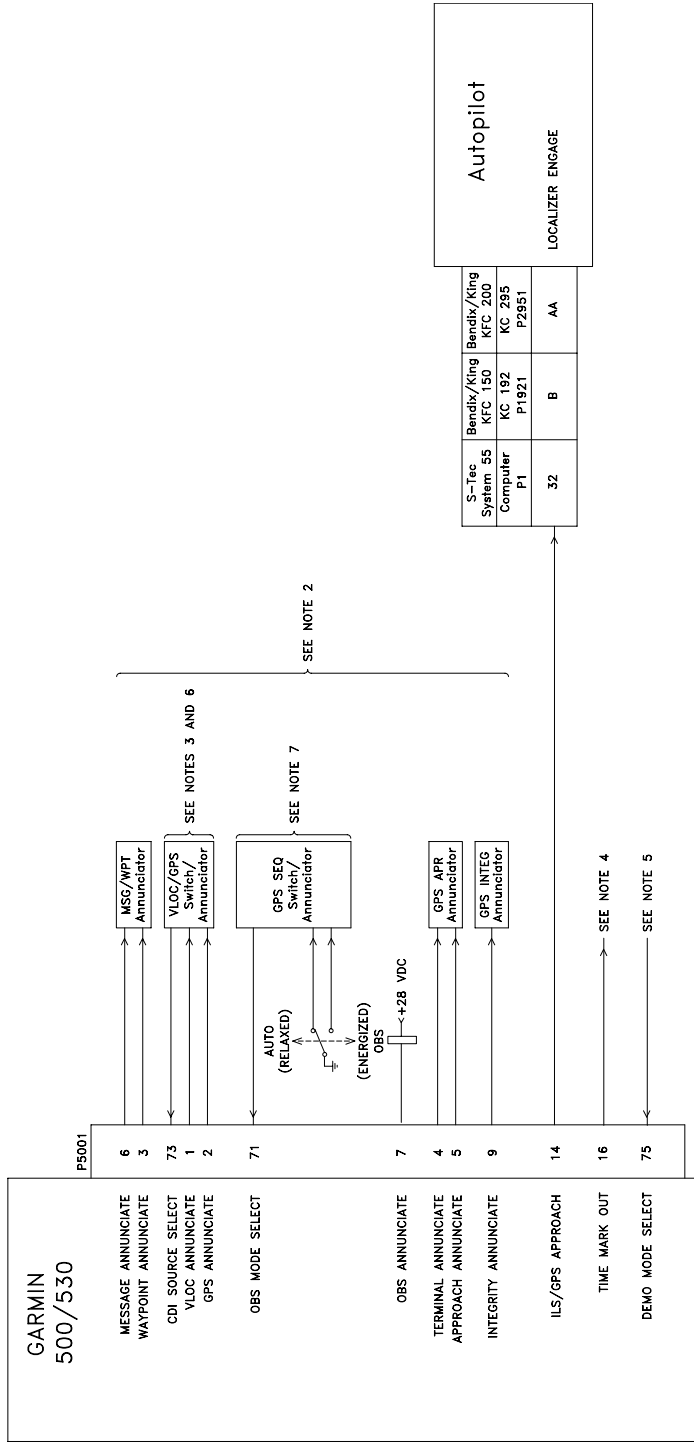

- NOTES:
1. ALL WIRES 24 AWG OR LARGER UNLESS OTHERWISE NOTED
 2. INITIAL CERTIFICATION OF THE 500 SERIES WAS ACCOMPLISHED WITHOUT USE OF ANY REMOTE SWITCHES OR ANNUNCIATORS, SINCE THE SAME SWITCHING AND ANNUNCIATION IS AVAILABLE ON THE FRONT PANEL OF THE GPS. HOWEVER, IF THE UNIT IS NOT INSTALLED IN THE PILOT'S NORMAL FIELD OF VIEW, SOME OR ALL OF THE REMOTE SWITCHES AND ANNUNCIATORS MAY BE REQUIRED BY YOUR CERTIFICATION AGENCY.
 3. AN EXTERNAL MOMENTARY VLOC/GPS SWITCH/ANNUNCIATOR OR ANNUNCIATOR (WITH NO SWITCH) MAY BE USED IN A GNS 530 INSTALLATION. A SWITCH SERVES THE SAME PURPOSE AS THE "CDI" BUTTON ON THE FRONT OF THE GNS 530.
 4. TIME MARK OUT (P5001-16) OUTPUTS A 1 MILLISECOND WIDE PULSE ONCE PER SECOND.
 5. DEMO MODE SELECT (P5001-75) MAY BE GROUNDED TO START THE UNIT IN DEMO MODE. DO NOT USE IN AN AIRCRAFT INSTALLATION.

6. P5001 PINS 73, 1, AND 2 HAVE NO FUNCTION ON GPS 500.
7. SINCE THE GNS 530 DOES INCLUDE ONLY AN 'OBS' ANNUNCIATOR (NOT AN 'AUTO' ANNUNCIATOR FOR THE NORMAL CASE), THE RELAY ARRANGEMENT SHOWN MAY BE USED IF DESIRED TO ANNUNCIATE 'AUTO'.
8. REFER TO MANUFACTURERS' DOCUMENTATION FOR COMPLETE PINOUT AND INTERCONNECT INFORMATION. PINOUTS OF OTHER UNITS SHOWN FOR REFERENCE ONLY.

Figure F-15. Annunciators/Switches Interconnect

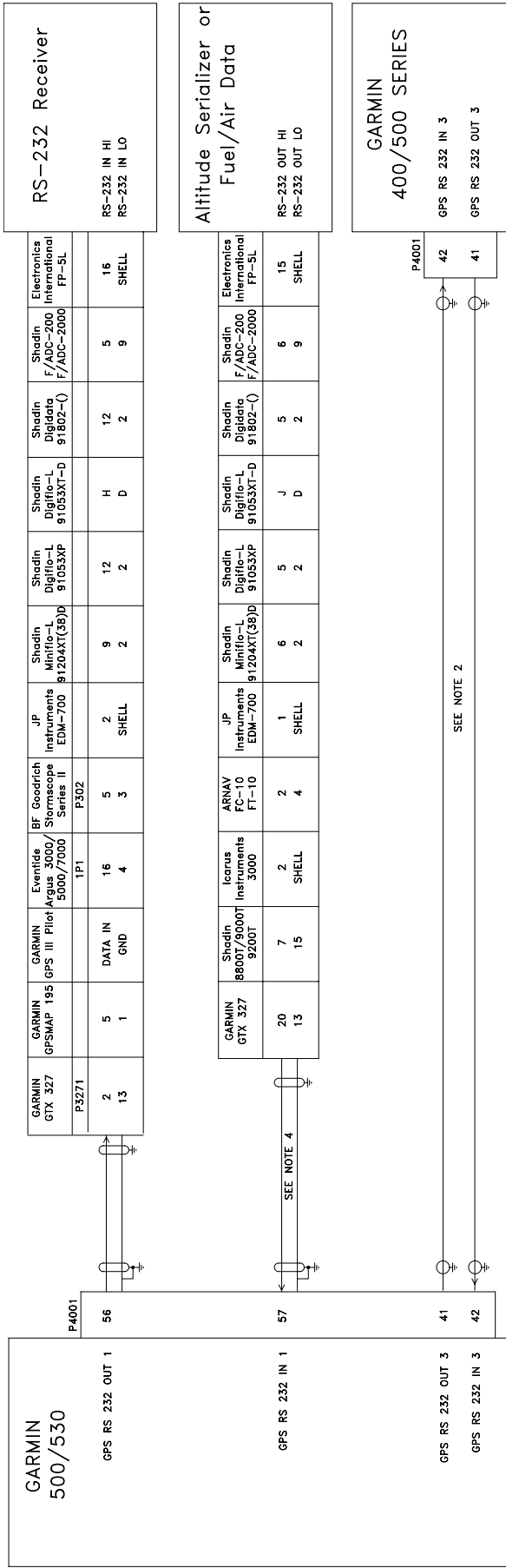

- NOTES:
1. ALL WIRES 24 AWG OR LARGER UNLESS OTHERWISE NOTED
 2. IF TWO OR MORE 400 SERIES UNITS ARE INSTALLED, THE RS-232 LINES ON P5001-41 AND P5001-42 MAY BE CROSS-CONNECTED TO CROSSFILL FLIGHT PLANS AND USER WAYPOINTS. TO CROSSFILL FLIGHT PLANS, IT IS REQUIRED THAT BOTH 400 SERIES UNITS HAVE IDENTICAL DATABASE CYCLE DATES AND MAY BE REQUIRED THAT THEY HAVE IDENTICAL VERSIONS OF MAIN SOFTWARE.
 3. REFER TO MANUFACTURERS' DOCUMENTATION FOR COMPLETE PINOUT AND INTERCONNECT INFORMATION. PINOUTS OF OTHER UNITS SHOWN FOR REFERENCE ONLY.
 4. REFER TO THE GTX 327 TRANSPONDER INSTALLATION MANUAL, 190-00187-02, FOR COMPLETE INFORMATION.

Figure F-16. RS-232 Serial Data Interconnect

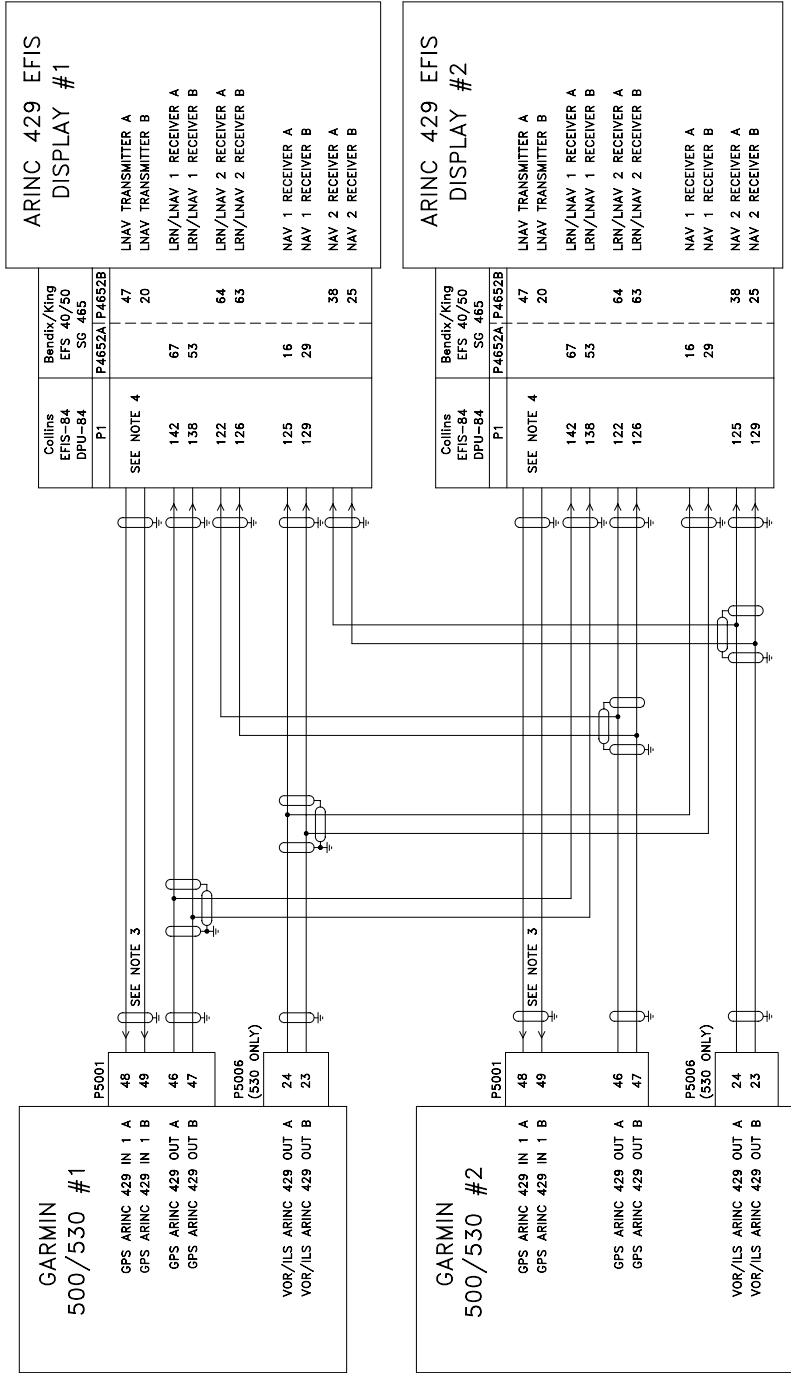

- NOTES:
1. ALL WIRES 24 AWG OR LARGER UNLESS OTHERWISE NOTED
 2. THE SDI CONFIGURATIONS (LNAV AND VOR/ILS) OF THE #1 500/530 MUST BE SET TO 1, AND THE SDI OF THE #2 UNIT MUST BE SET TO 2 FOR PROPER OPERATION.
 3. IF THE GPS ARINC 429 IN 1 PORT (P5001-48 AND -49) IS ALREADY USED FOR ANOTHER PURPOSE, THE GPS ARINC 429 IN 2 PORT (P5001-50 AND -51) MAY BE CONNECTED INSTEAD.
 4. THE DEPICTED COLLINS EFIS-84 INTERFACE DOES NOT SUPPORT SELECTION OF THE GPS COURSE VIA THE EFIS CONTROL PANEL. A GARMIN GAD 42 IS REQUIRED FOR GPS SELECTED COURSE. REFER TO THE GAD 42 INSTALLATION MANUAL.
 5. REFER TO MANUFACTURERS' DOCUMENTATION FOR COMPLETE PINOUT AND INTERCONNECT INFORMATION. PINOUTS OF OTHER UNITS SHOWN FOR REFERENCE ONLY.

Figure F-17. ARINC 429 EFIS Interconnect

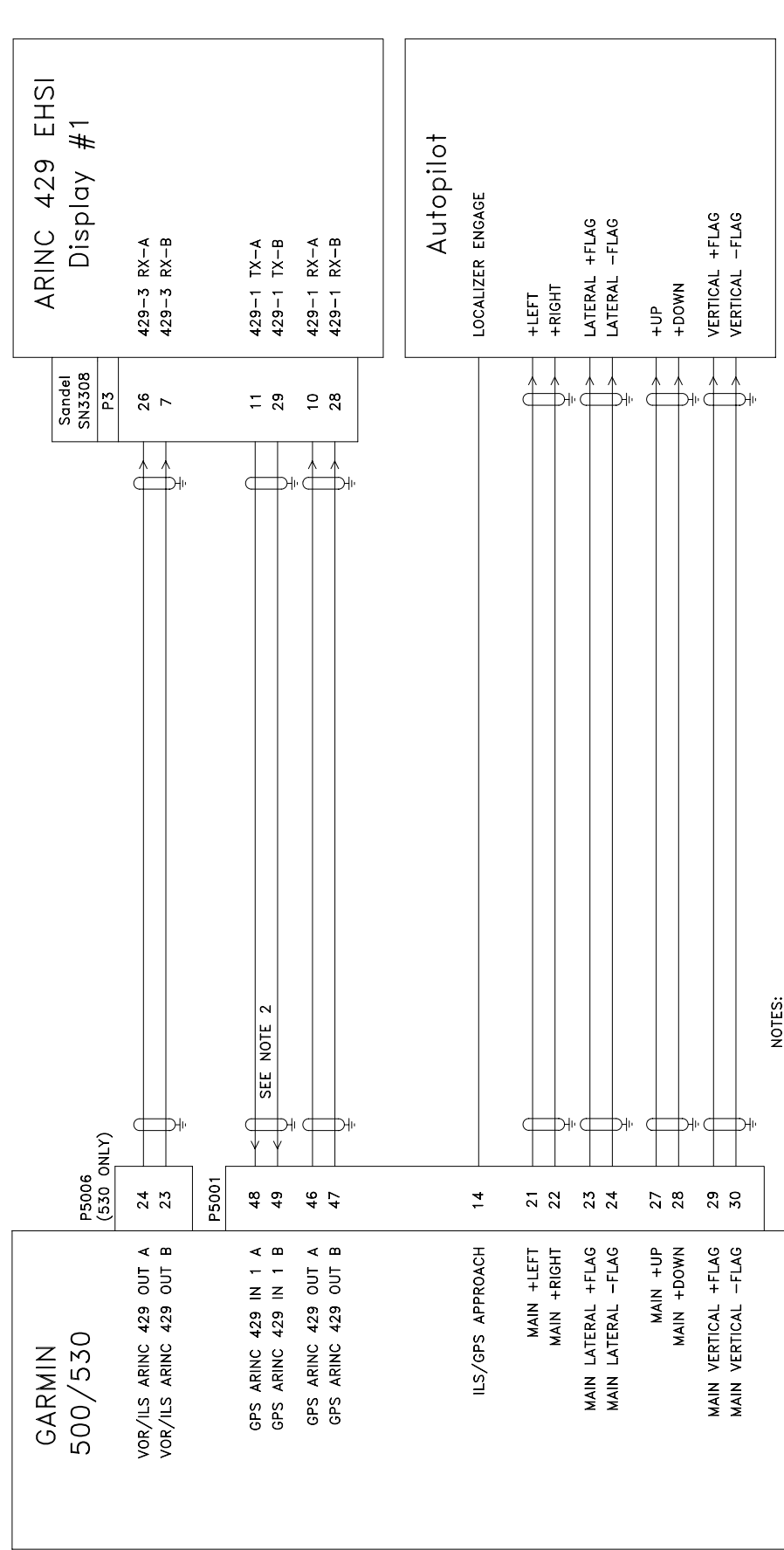

NOTES:

1. ALL WIRES 24 AWG OR LARGER UNLESS OTHERWISE NOTED
2. IF THE GPS ARINC 429 IN 1 PORT (P5001-48 AND -49) IS ALREADY USED FOR ANOTHER PURPOSE, THE GPS ARINC 429 IN 2 PORT (P5001-50 AND -51) MAY BE CONNECTED INSTEAD.
3. REFER TO MANUFACTURERS' DOCUMENTATION FOR COMPLETE PINOUT AND INTERCONNECT INFORMATION. PINOUTS OF OTHER UNITS SHOWN FOR REFERENCE ONLY.

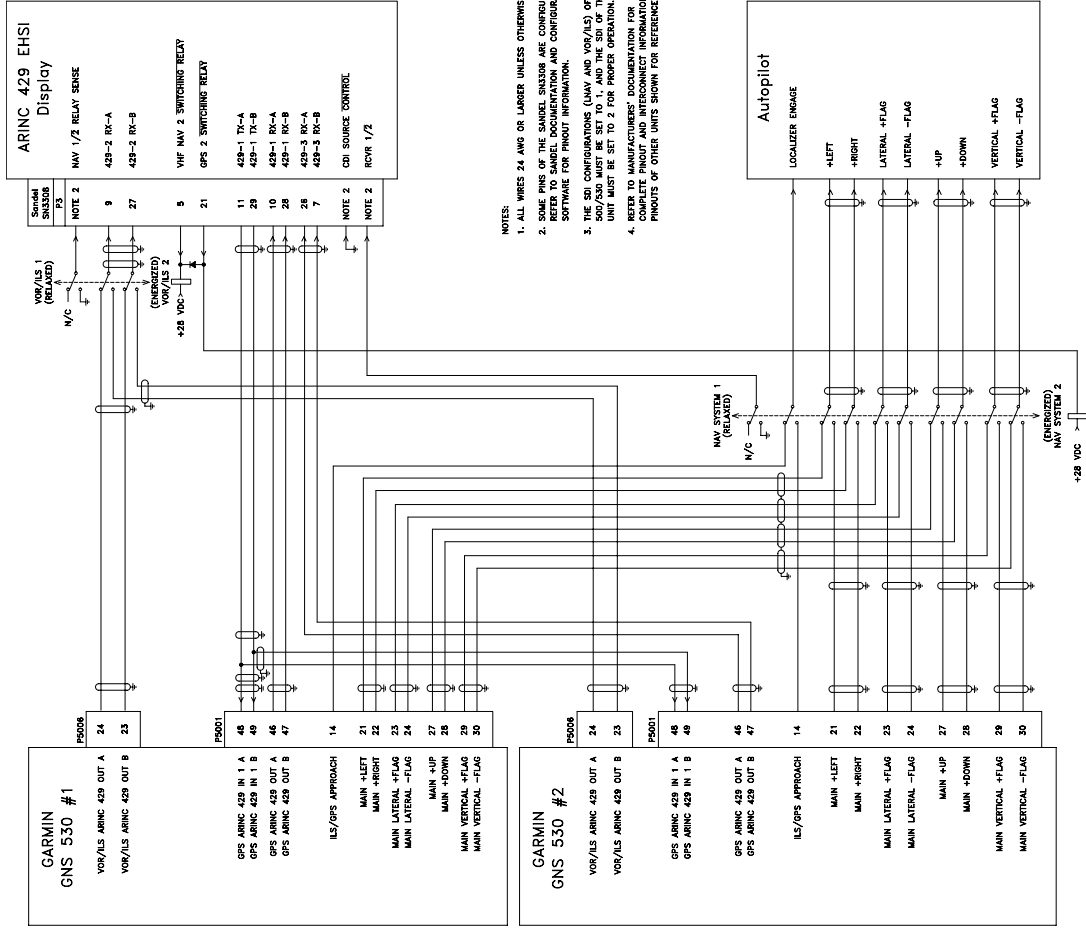
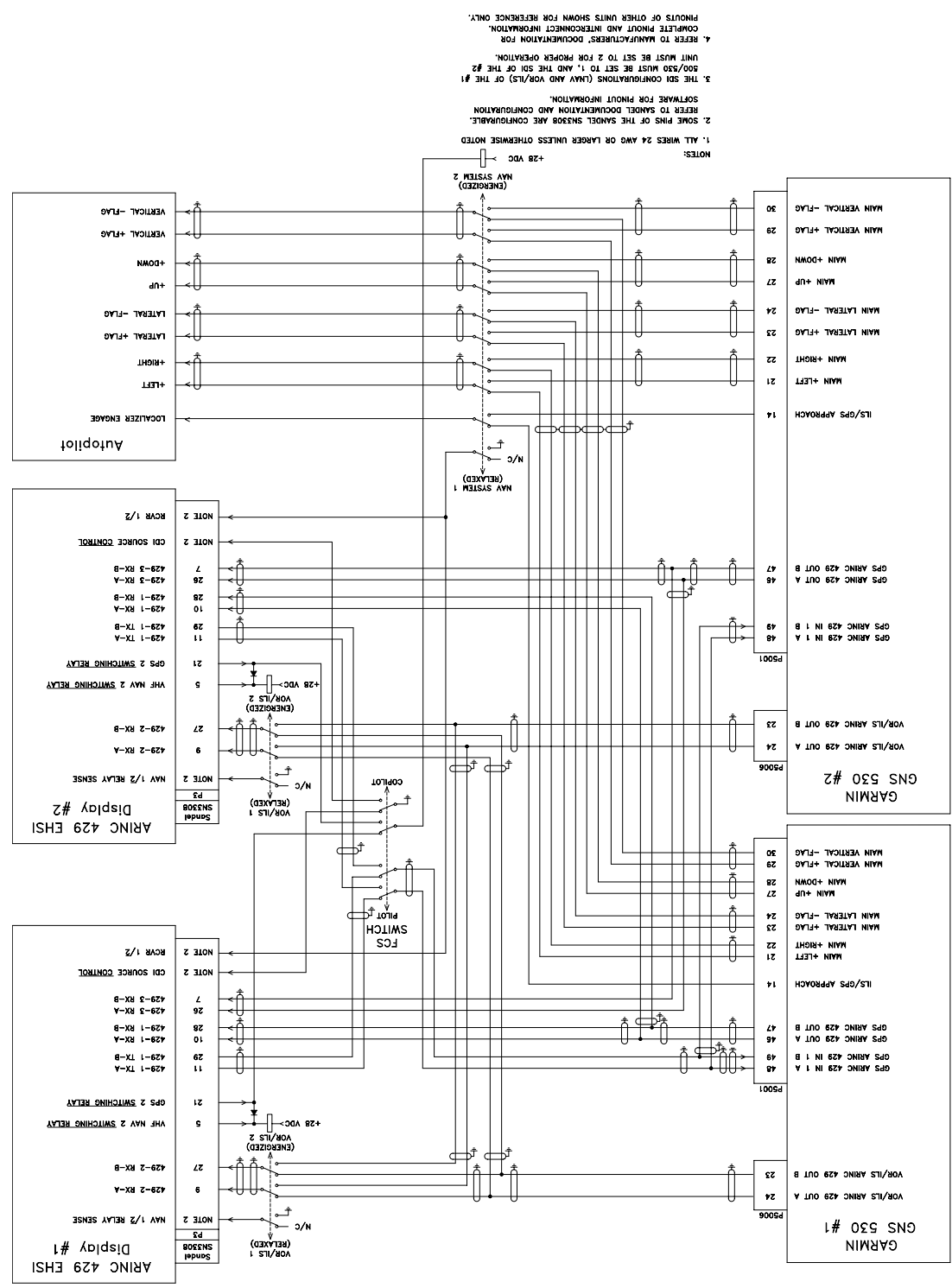
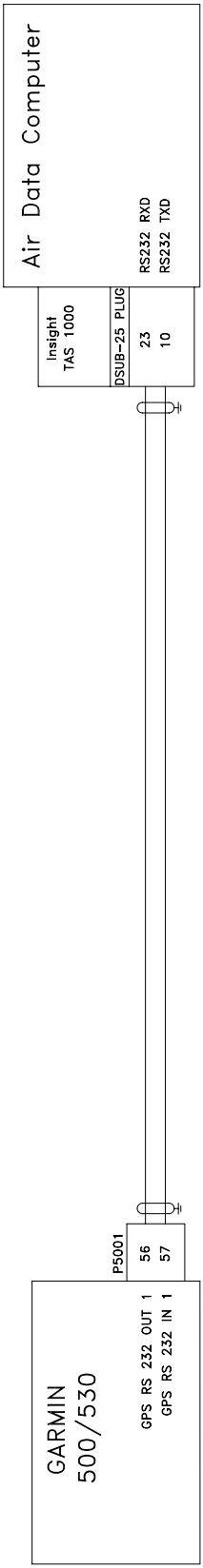
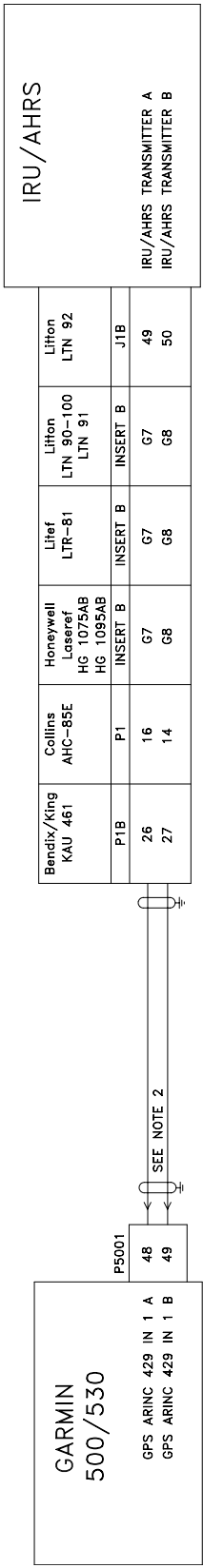
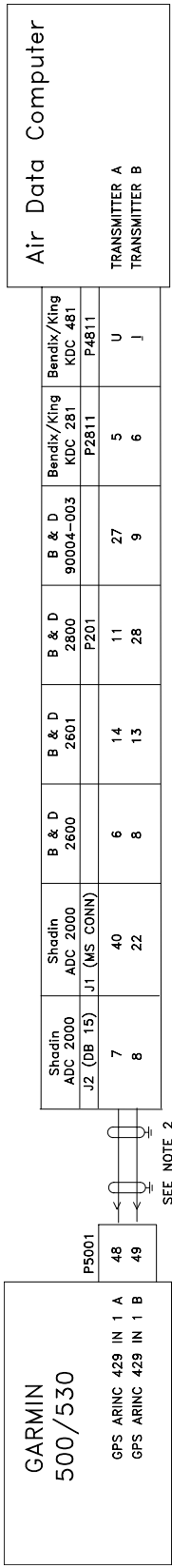

Figure F-19. ARINC 429 Sander EHSI Interconnect (2 GNS 530, 1 Sander SN3308)



- NOTES:
1. ALL WIRES 24 AWG OR LARGER UNLESS OTHERWISE NOTED
 2. SOME PINS OF THE SANDER SN3308 ARE CONFIGURABLE. REFER TO SANDER DOCUMENTATION AND CONFIGURATION SOFTWARE FOR PINOUT INFORMATION.
 3. THE SBI CONFIGURATIONS (LNAV AND VOR/LS) OF THE #1 AND #2 MUST BE SET TO 2 FOR PROPER OPERATION.
 4. REFER TO MANUFACTURERS' DOCUMENTATION FOR COMPLETE PINOUT AND INTERCONNECT INFORMATION. PINOUTS OF OTHER UNITS SHOWN FOR REFERENCE ONLY.

Figure F-20. ARINC 429 Sandel EHSI Interconnect (2 GNS 530, 2 Sandel SN3308)



- NOTES:
1. ALL WIRES 24 AWG OR LARGER UNLESS OTHERWISE NOTED.
 2. IF THE GPS ARINC 429 IN 1 PORT (P5001-48 AND -49) IS ALREADY USED FOR ANOTHER PURPOSE, THE GPS ARINC 429 IN 2 PORT (P5001-50 AND -51) MAY BE CONNECTED INSTEAD.
 3. LOWER CASE PIN DESIGNATORS ARE SHOWN AS UNDERLINED UPPER CASE LETTERS.
 4. REFER TO MANUFACTURERS' DOCUMENTATION FOR COMPLETE PINOUT AND INTERCONNECT INFORMATION. PINOUTS OF OTHER UNITS SHOWN FOR REFERENCE ONLY.
 5. DASHED RECTANGLE INDICATES CHANGED CONTENT.

Figure F-21. ARINC 429/RS-232 Air Data/IRU/AHRS Interconnect

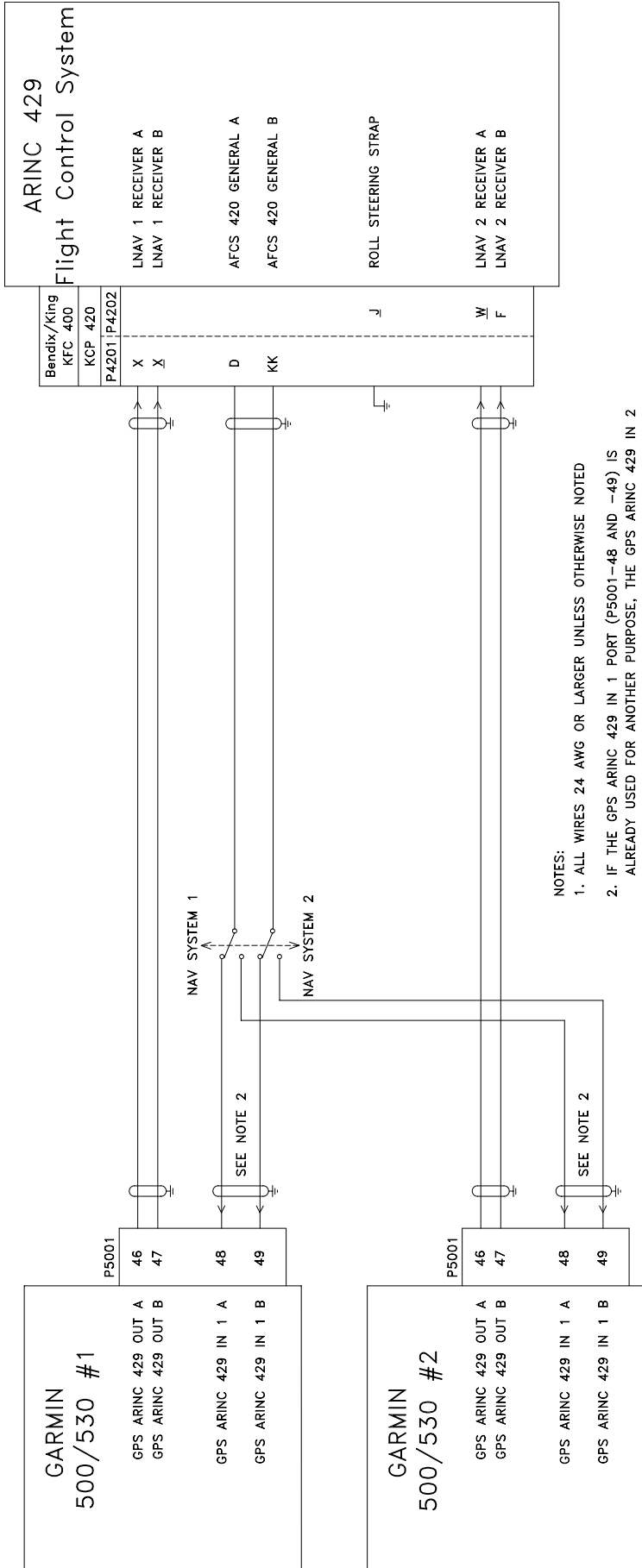

- NOTES:
1. ALL WIRES 24 AWG OR LARGER UNLESS OTHERWISE NOTED
 2. IF THE GPS ARINC 429 IN 1 PORT (P5001-48 AND -49) IS ALREADY USED FOR ANOTHER PURPOSE, THE GPS ARINC 429 IN 2 PORT (P5001-50 AND -51) MAY BE CONNECTED INSTEAD.
 3. LOWER CASE PIN DESIGNATORS ARE SHOWN AS UNDERLINED UPPER CASE LETTERS.
 4. REFER TO MANUFACTURERS' DOCUMENTATION FOR COMPLETE PINOUT AND INTERCONNECT INFORMATION. PINOUTS OF OTHER UNITS SHOWN FOR REFERENCE ONLY.

Figure F-22. ARINC 429 Flight Control Interconnect

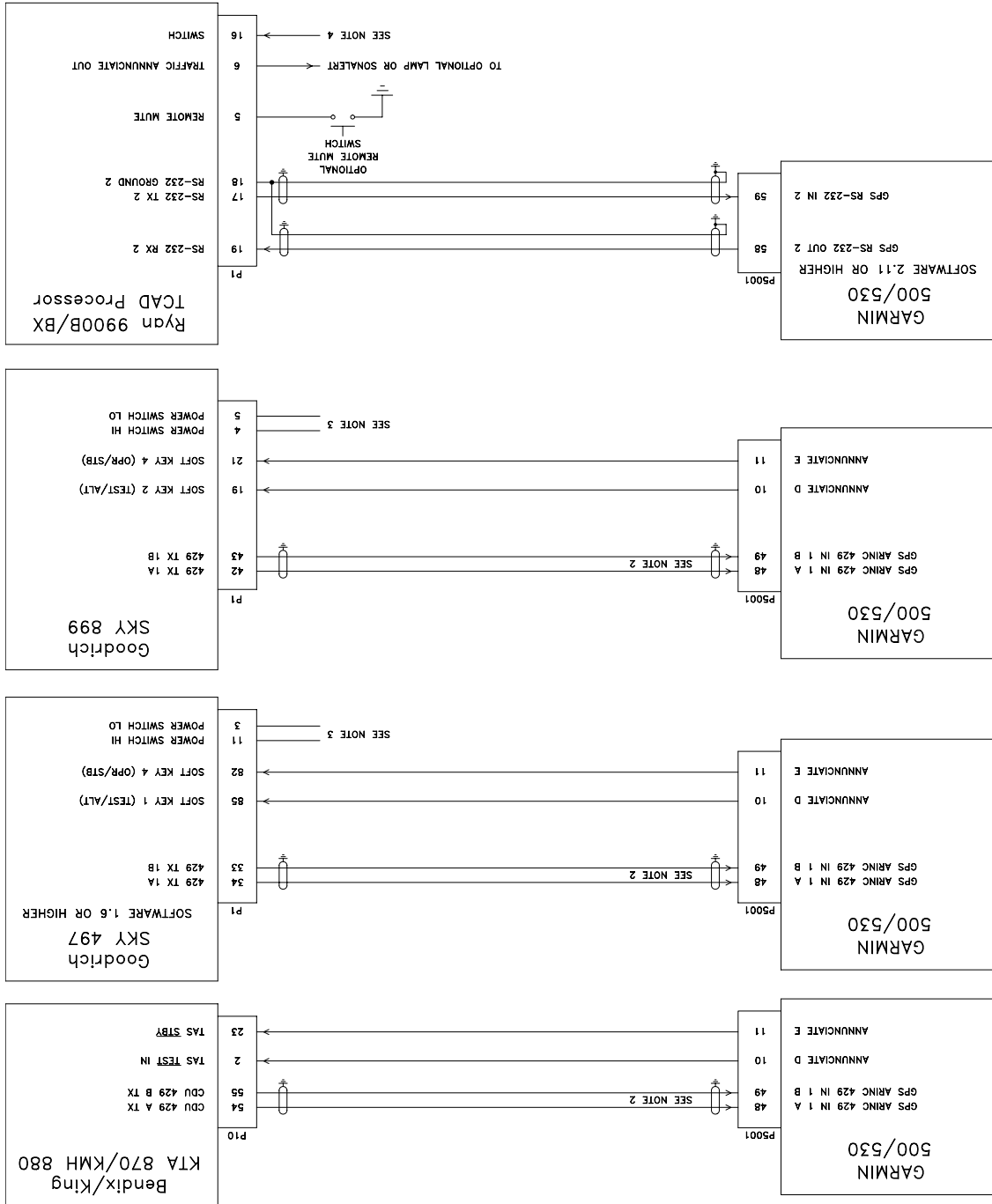

- NOTES:
1. ALL WIRES 24 AWG OR LARGER UNLESS OTHERWISE NOTED.
 2. IF THE GPS ARINC 429 IN 1 PORT (P5001-48 AND -49) IS ALREADY USED FOR ANOTHER PURPOSE, THE GPS ARINC 429 IN 2 PORT (P5001-50 AND -51) MAY BE CONNECTED INSTEAD.
 3. THE SKYWATCH POWER SWITCH PINS, SHOWN ON P1, SHOULD BE CONNECTED TOGETHER TO TURN THE PROCESSOR UNIT ON AND OPEN TO TURN THIS UNIT OFF. IF A SKYWATCH CONTROL/DISPLAY UNIT IS NOT IN THE INSTALLATION, A DEDICATED SWITCH MAY BE REQUIRED TO TURN THE SKYWATCH PROCESSOR UNIT ON AND OFF.
 4. THE RYAN TCAD PROCESSOR SWITCH PIN (P1-16) SHOULD BE GROUNDED TO TURN THE PROCESSOR UNIT ON, AND OPEN TO TURN THIS UNIT OFF. IF A RYAN TCAD DISPLAY UNIT IS NOT IN THE INSTALLATION, A DEDICATED SWITCH MAY BE REQUIRED TO TURN THE TCAD PROCESSOR UNIT ON AND OFF.
 5. IF ANY OF THESE TRAFFIC SYSTEMS IS INSTALLED WITHOUT A CONTROL/DISPLAY UNIT, A PLACARD IS REQUIRED NEAR THE 500 SERIES UNIT, INDICATING THAT A TRAFFIC ADVISORY SYSTEM IS INSTALLED, AND ITS DATA MAY BE DISPLAYED ON THE 500 SERIES UNIT.
6. IN ORDER FOR RYAN TCAD TRAFFIC TO BE DISPLAYED ON THE 500 SERIES UNIT'S MAP PAGE, THE 500 SERIES UNIT MUST HAVE A DIGITAL HEADING SOURCE.
 7. IN ORDER FOR SKYWATCH DATA TO BE DISPLAYED ON THE 500 SERIES UNIT'S MAP PAGE, THE 500 SERIES UNIT MUST HAVE A DIGITAL HEADING SOURCE, OR THE SKYWATCH UNIT MUST HAVE A SYNCRO OR SERIAL HEADING SOURCE. A STEPPER HEADING SOURCE WILL NOT ALLOW SKYWATCH DATA TO BE DISPLAYED ON THE MAP PAGE.
 8. THIS DRAWING IDENTIFIES SPECIFIC RS-232 PORTS. CONFIGURATION OF 500 SERIES UNITS WITH MAIN SOFTWARE VERSION 2.04 OR EARLIER REQUIRES THESE SPECIFIC PORTS. MAIN SOFTWARE VERSION 2.05 OR LATER DOES NOT HAVE THIS LIMITATION, SUCH THAT ANY SERIAL FORMAT CAN BE SELECTED ON ANY OF THE FOUR RS-232 PORTS.
 9. REFER TO MANUFACTURERS' DOCUMENTATION FOR COMPLETE PINOUT AND INTERCONNECT INFORMATION. PINOUTS OF OTHER UNITS SHOWN FOR REFERENCE ONLY.

Figure F-23. Traffic Advisory System Interconnect

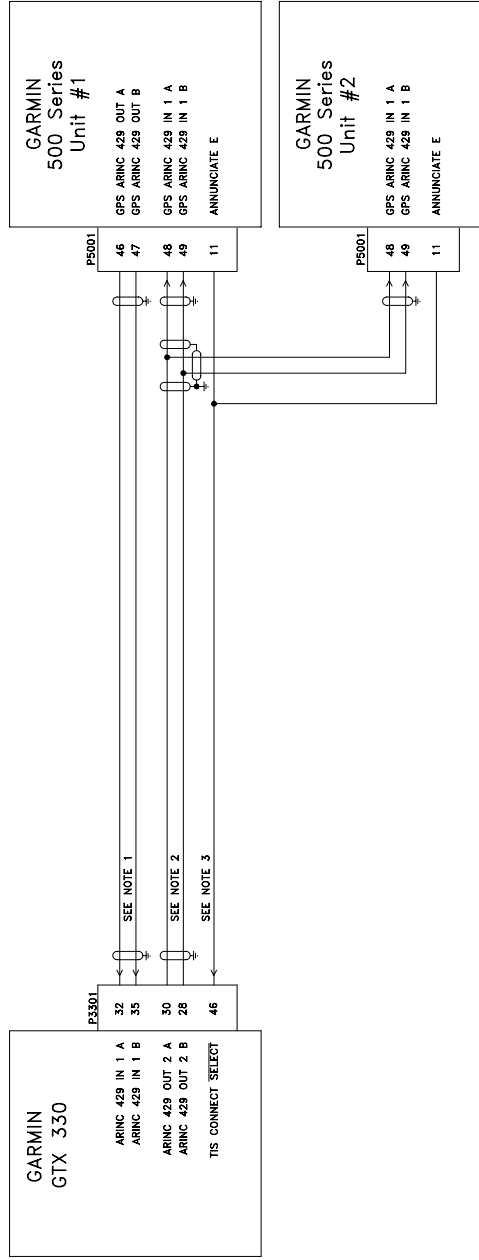

NOTES:

1. ARINC 429 IN 1 (P3301-32 AND -35) INPUT ALLOWS AUTOMATED START AND STOP OF FLIGHT TIMER AND PLACES THE TRANSPONDER IN GROUND (GND) MODE UPON LANDING.
2. IF EXTERNAL STBY SELECT IS CONNECTED IN THIS CONFIGURATION, USE AIRINC 429 OUT 1 A AND 1 B, (PINS 37 AND 34) RATHER THAN AIRINC 429 OUT 2 A AND 2 B (PINS 30 AND 28). SHOWAL ALTITUDE DATA WILL NOT BE SHOWN. AIRINC 429 IN 1 A AND 1 B TO THE 500 SERIES UNIT WHEN EXTERNAL STBY SELECT IS GROUND.
3. WHEN TIS IS USED IN THE AIRCRAFT DO NOT CONNECT ANOTHER TRAFFIC SYSTEM TO THE SAME 500 SERIES UNIT.

Figure F-24. GTX 330 Interconnect

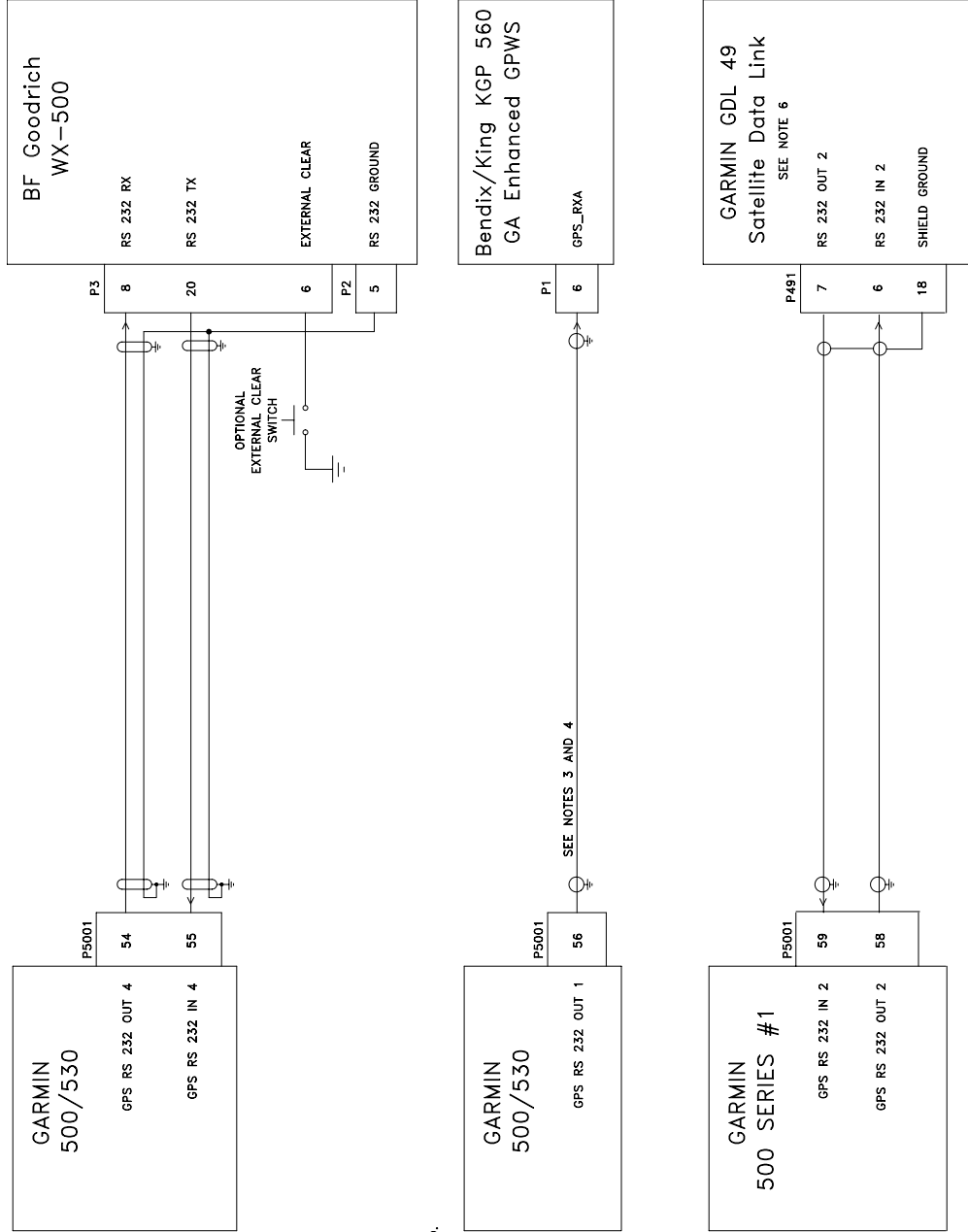

- NOTES:
1. ALL WIRES 24 AWG OR LARGER UNLESS OTHERWISE NOTED
 2. IN ORDER FOR WX-500 DATA TO BE DISPLAYED ON THE 500 SERIES UNIT'S MAP PAGE, THE 500 SERIES UNIT MUST HAVE A DIGITAL HEADING SOURCE, OR THE WX-500 MUST HAVE A SYNCHRO OR SERIAL HEADING SOURCE. A STEPPER HEADING SOURCE WILL NOT ALLOW WX-500 DATA TO BE DISPLAYED ON THE MAP PAGE.
 3. THIS DRAWING IDENTIFIES SPECIFIC RS 232 PORTS. CONFIGURATION OF 500 SERIES UNITS WITH MAIN SOFTWARE VERSION 2.04 OR EARLIER REQUIRES THESE SPECIFIC PORTS. MAIN SOFTWARE VERSION 2.05 OR LATER DOES NOT HAVE THIS LIMITATION, SUCH THAT ANY SERIAL FORMAT CAN BE SELECTED ON ANY OF THE FOUR RS 232 PORTS.
 4. IF AN RS 232 OUTPUT PORT IS CONFIGURED FOR THE HONEYWELL EGPWS, THE CORRESPONDING RS 232 INPUT OF THE SAME PORT MAY NOT BE USED.
 5. REFER TO MANUFACTURERS' DOCUMENTATION FOR COMPLETE PINOUT AND INTERCONNECT INFORMATION. PINOUTS OF OTHER UNITS SHOWN FOR REFERENCE ONLY.
 6. CONNECTION TO RS 232 PORT #2 OF THE 500 SERIES UNIT IS SHOWN. IF PORT #2 IS ALREADY IN USE, ANY OTHER AVAILABLE RS 232 PORT MAY BE USED AS WELL.

Figure F-25. Weather and Terrain Interconnect

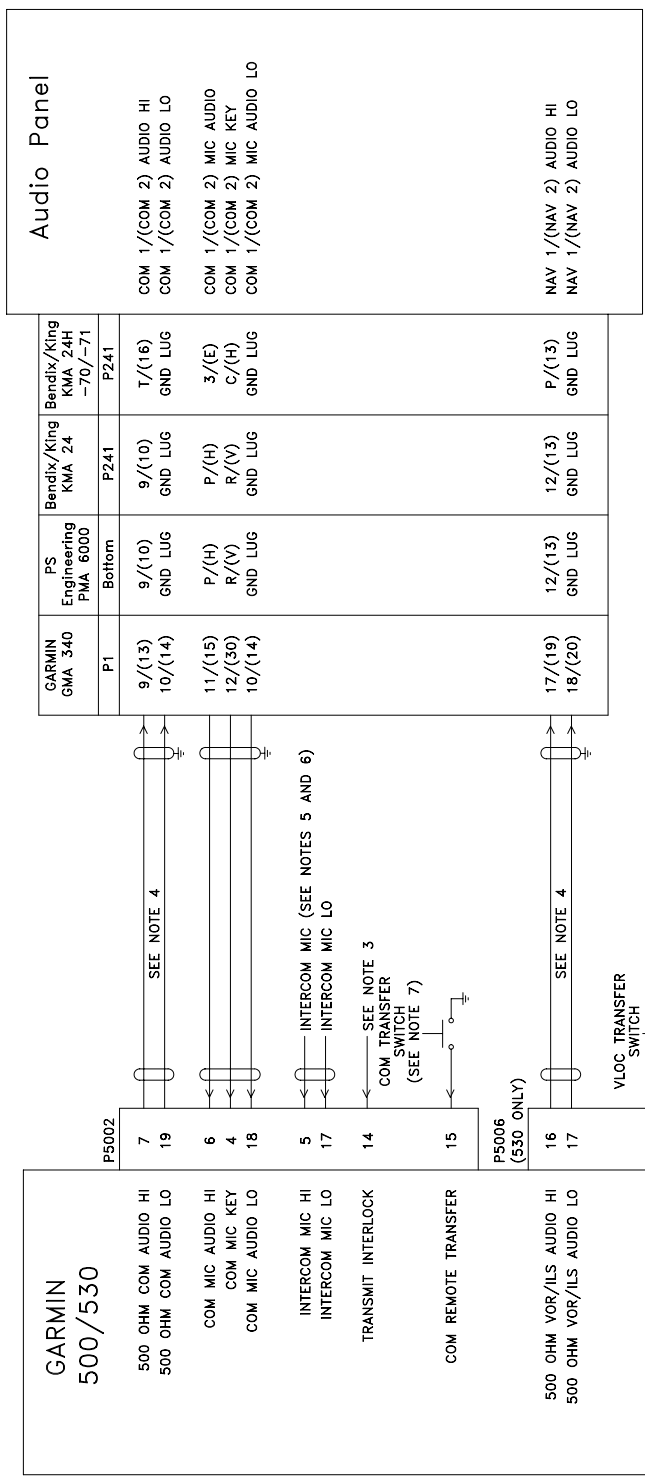

- NOTES:
1. ALL WIRES 24 AWG OR LARGER UNLESS OTHERWISE NOTED
 2. CONNECTING TWO MICROPHONES TO MIC AUDIO HI/LO OR INTERCOM MIC HI/LO AT THE SAME TIME MAY RESULT IN WEAK OR DISTORTED AUDIO. MIC ISOLATION RELAYS ARE RECOMMENDED SO THAT ONLY ONE MIC IS ACTIVE AT A TIME.
 3. CONNECT TRANSMIT INTERLOCK (P5002-14) TO THE OTHER TRANSCIEVER'S MIC KEY TO MINIMIZE SQUELCH BREAKS ON THE GNS 530 COM.
 4. THE 500 OHM AUDIO OUTPUTS ARE BALANCED OUTPUTS AND THE LO OUTPUTS MUST BE CONNECTED. IF THE AUDIO PANEL DOES NOT HAVE A LO INPUT, IT SHOULD BE CONNECTED TO A GROUND LUG AT THE AUDIO PANEL.
 5. THE GNS 530 INTERCOM FUNCTION SHOULD ONLY BE USED IF THERE IS NO OTHER INTERCOM SYSTEM IN THE AIRCRAFT.
 6. INTERCOM WIRING OPTION:
 7. THE COM REMOTE TRANSFER INPUT (P5002-15) MAY BE USED FOR EMERGENCY OPERATION OF THE COM TRANSMITTER. IF THE REMOTE TRANSFER SWITCH IS ACTIVE FOR TWO SECONDS, THE ACTIVE COM FREQUENCY WILL CHANGE TO 121.50 MHZ. REFER TO SECTION 4.7.1.
 8. REFER TO MANUFACTURERS' DOCUMENTATION FOR COMPLETE PINOUT AND INTERCONNECT INFORMATION. PINOUTS OF OTHER UNITS SHOWN FOR REFERENCE ONLY.

GARMIN GNS 530		Navigation Indicator																	
P5006		GARMIN GI 102/A	P1	Bendix/King KI 202	P2021	Bendix/King KI 206	P2061	Bendix/King KI 203	P2031	Bendix/King KI 204	P2041	Bendix/King KI 208	P2081	Bendix/King KI 209	P2091	Bendix/King KI 208A	P208A1	Bendix/King KI 209A	P209A1
VOR/LOC +LEFT	5		11	N	N	N	N												+LEFT
VOR/LOC +RIGHT	6		12	J	J	J	J												+RIGHT
VOR/LOC +TO	1		9	E	E	E	E												+TO
VOR/LOC +FROM	2		10	S	S	S	S												+FROM
VOR/LOC +FLAG	3		7	N	N	N	N												NAV +FLAG
VOR/LOC -FLAG	4		8	F	F	F	F												NAV -FLAG
VOR/LOC SUPERFLAG	15																		NAV SUPERFLAG
VOR/LOC COMPOSITE OUT	8											Y	Y	2	2	6	6	6	NAV SUPERFLAG LO
ILS ENERGIZE	29											K	K	4	4	10	10	10	VOR/LOC COMPOSITE
GLIDESLOPE +UP	32											K	K	3	3				ILS ENERGIZE
GLIDESLOPE +DOWN/-FLAG	31											M	M	6	6				+UP
GLIDESLOPE +FLAG	30											H	H	9	9				+DOWN
GLIDESLOPE SUPERFLAG	38											J	J	12	12				GLIDESLOPE +FLAG
VOR OBS ROTOR H	10		1	C	C	C	C												GLIDESLOPE -FLAG
VOR OBS ROTOR C	9		2	Z	Z	Z	Z												GLIDESLOPE SUPERFLAG
VOR OBS STATOR D	13		3	L	L	L	L												OBS A/H
VOR OBS STATOR E/G	11		5	P	P	P	P												OBS C
VOR OBS STATOR F	12		4	T	T	T	T												OBS D (COS HI)
			6	W	W	W	W												OBS E (COS LO)
																			OBS F (SIN HI)
																			OBS G (SIN LO)

- NOTES:
- ALL WIRES 24 AWG OR LARGER UNLESS OTHERWISE NOTED
 - LOWER CASE PIN DESIGNATORS ARE SHOWN AS UNDERLINED UPPER CASE LETTERS.
 - THIS INTERCONNECT APPLIES ONLY WHEN IT IS DESIRED FOR A SEPARATE INDICATOR TO DISPLAY GNS 530 VOR/ILS INFORMATION (REGARDLESS OF THE "CDI" BUTTON STATUS).
 - REFER TO MANUFACTURERS' DOCUMENTATION FOR COMPLETE PINOUT AND INTERCONNECT INFORMATION. PINOUTS OF OTHER UNITS SHOWN FOR REFERENCE ONLY.

Figure F-27. VOR/ILS Indicator Interconnect

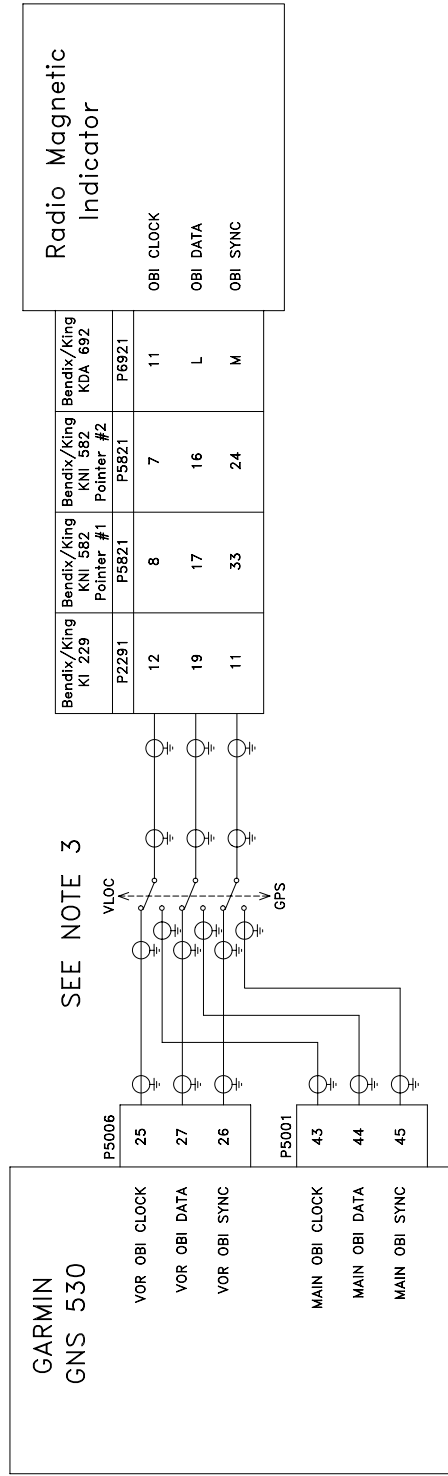
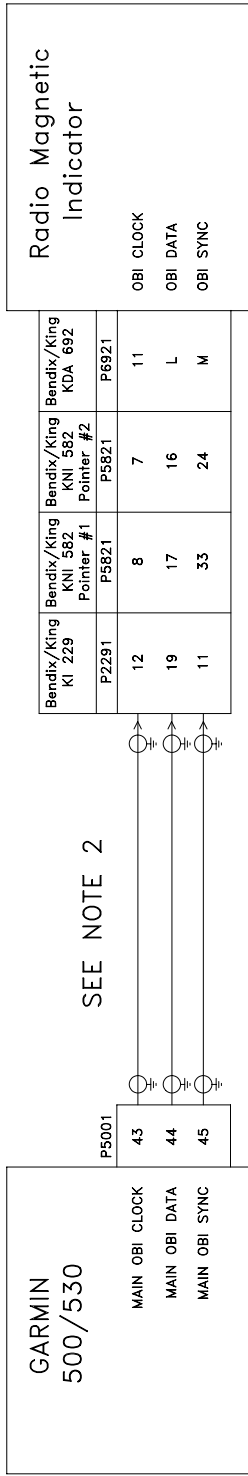

- NOTES:
1. ALL WIRES 24 AWG OR LARGER UNLESS OTHERWISE NOTED
 2. IF IT IS DESIRED FOR THE RMI POINTER TO SWITCH WITH THE CDI BUTTON ON THE FRONT PANEL OF THE GNS 530, INSTALL AS PER THE TOP DIAGRAM, AND SELECT "TRACK CDI" FOR THE "OBI SOURCE" FIELD OF THE "MAIN CDI/OBS CONFIG" PAGE.
 3. IF IT IS DESIRED TO USE A SEPARATE SWITCH FOR THE RMI POINTER, INSTALL AS PER THE BOTTOM DIAGRAM, AND SELECT "ALWAYS GPS" FOR THE "OBI SOURCE" FIELD OF THE "MAIN CDI/OBS CONFIG" PAGE.
 4. REFER TO MANUFACTURERS' DOCUMENTATION FOR COMPLETE PINOUT AND INTERCONNECT INFORMATION. PINOUTS OF OTHER UNITS SHOWN FOR REFERENCE ONLY.

Figure F-28. RMI/OBI Interconnect
 Page F-57 (Page F-58 blank)
 Rev J

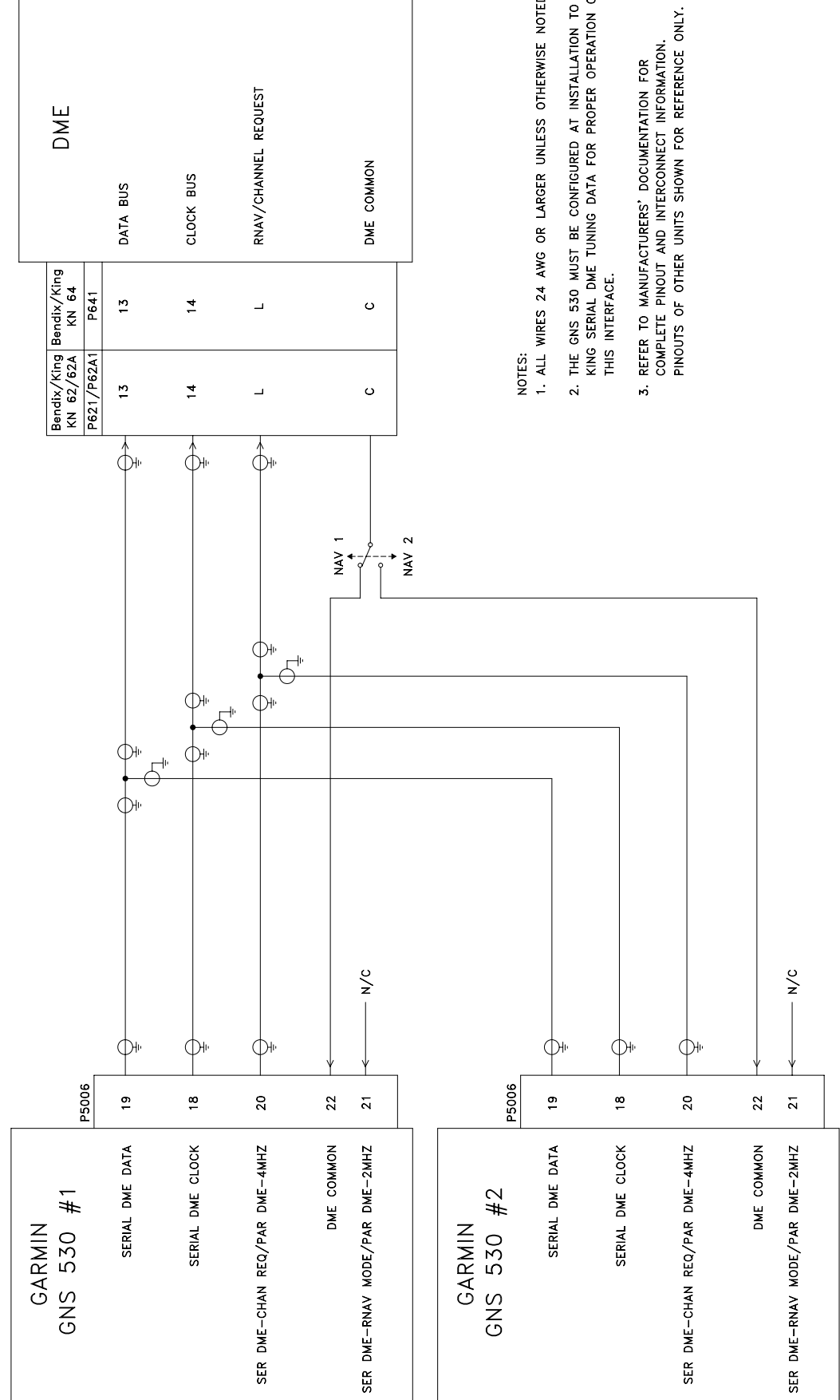

NOTES:

1. ALL WIRES 24 AWG OR LARGER UNLESS OTHERWISE NOTED
2. THE GNS 530 MUST BE CONFIGURED AT INSTALLATION TO OUTPUT KING SERIAL DME TUNING DATA FOR PROPER OPERATION OF THIS INTERFACE.
3. REFER TO MANUFACTURERS' DOCUMENTATION FOR COMPLETE PINOUT AND INTERCONNECT INFORMATION. PINOUTS OF OTHER UNITS SHOWN FOR REFERENCE ONLY.

Figure F-29. King Serial Panel DME Tuning Interconnect

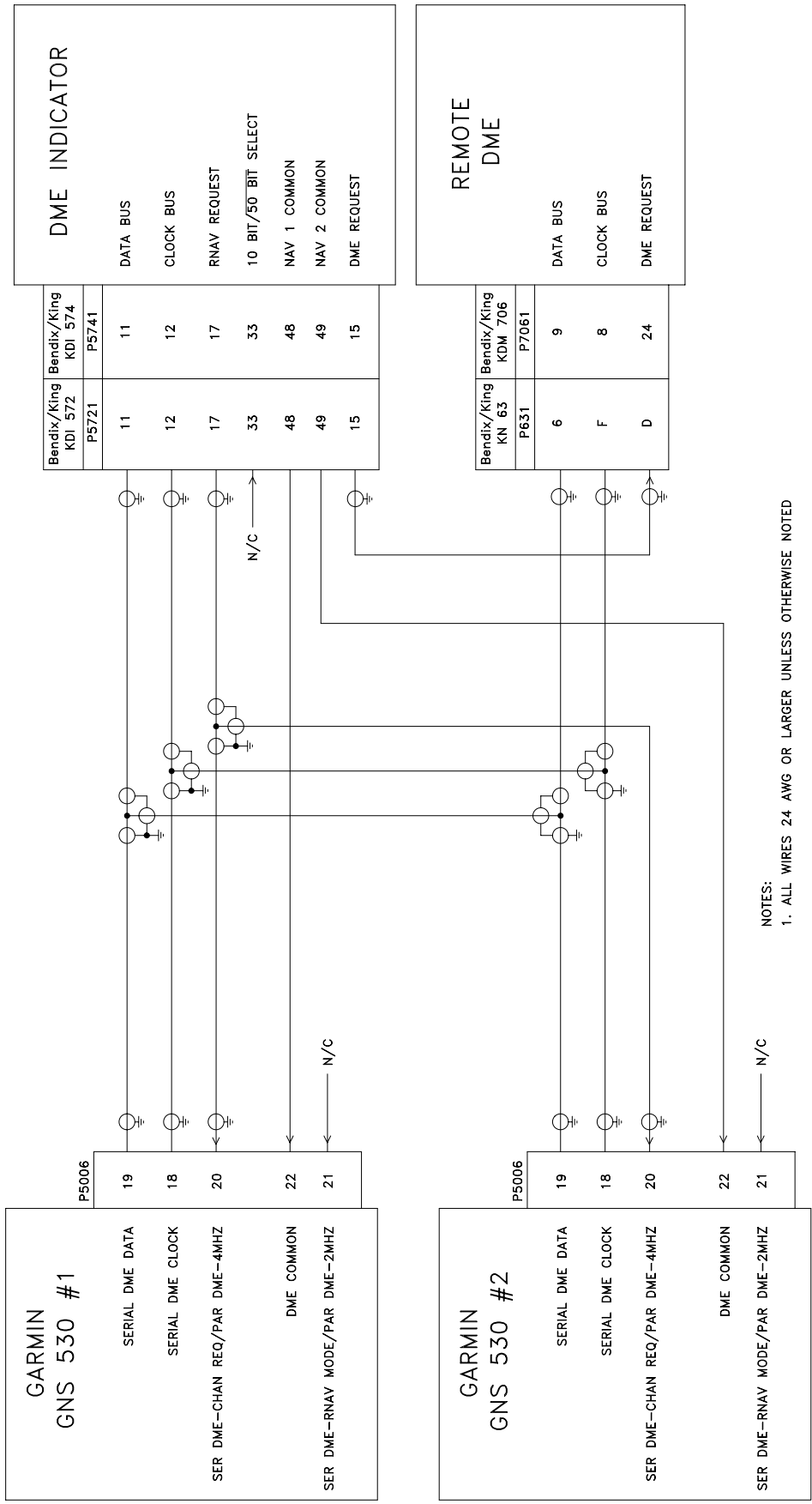
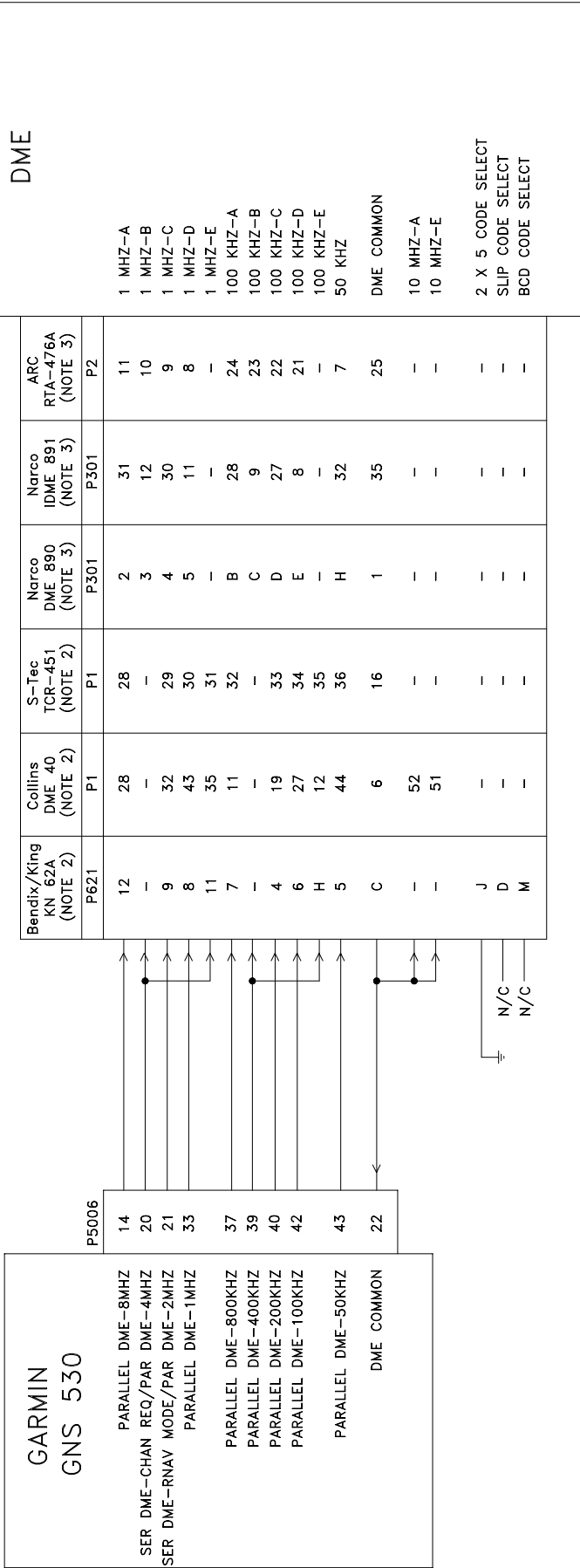
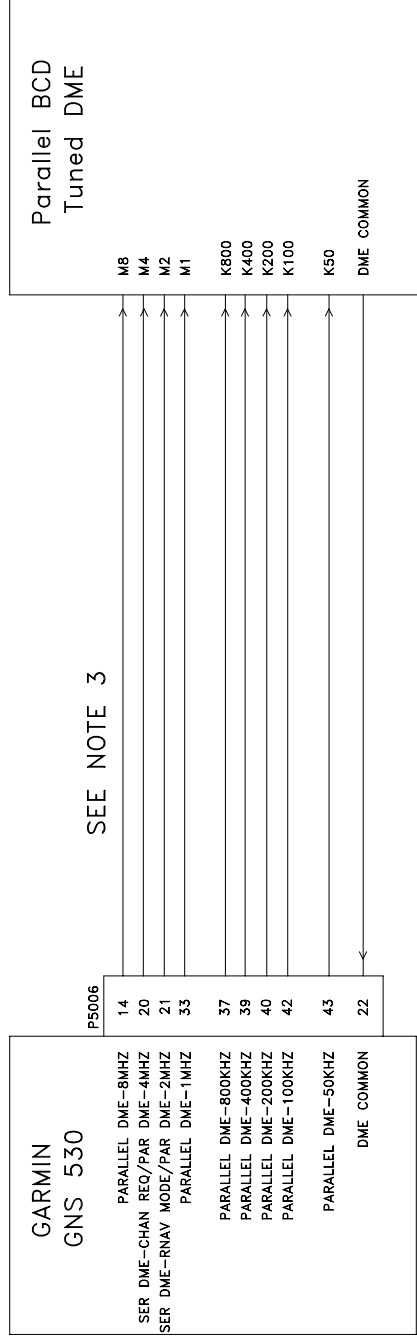
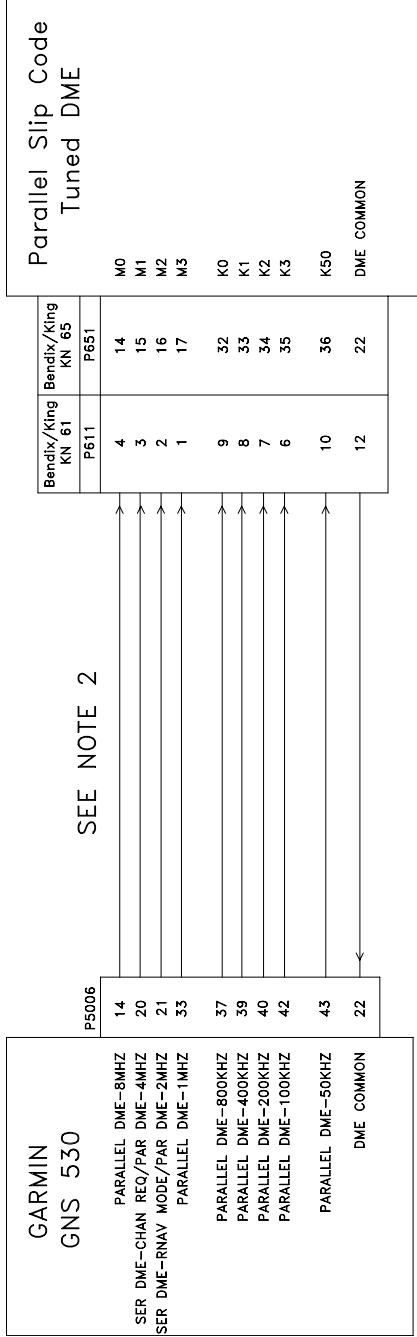

Figure F-30. King Serial Remote DME Tuning Interconnect



- NOTES:
1. ALL WIRES 24 AWG OR LARGER UNLESS OTHERWISE NOTED
 2. THE GNS 530 MUST BE CONFIGURED FOR 'PARALLEL 2x5' DME CHANNELLING MODE FOR PROPER OPERATION WITH THIS MODEL OF DME TRANSMITTER.
 3. THE GNS 530 MUST BE CONFIGURED FOR 'NARCO 890/891' DME CHANNELLING MODE FOR PROPER OPERATION WITH THIS MODEL OF DME TRANSMITTER.
 4. REFER TO MANUFACTURERS' DOCUMENTATION FOR COMPLETE PINOUT AND INTERCONNECT INFORMATION. PINOUTS OF OTHER UNITS SHOWN FOR REFERENCE ONLY.

Figure F-31. Parallel 2 OF 5 DME Tuning Interconnect



- NOTES:
1. ALL WIRES 24 AWG OR LARGER UNLESS OTHERWISE NOTED.
 2. THE GNS 530 MUST BE CONFIGURED TO OUTPUT SLIP CODE DME TUNING DATA FOR PROPER OPERATION IN THIS CONFIGURATION.
 3. THE GNS 530 MUST BE CONFIGURED TO OUTPUT BCD DME TUNING DATA FOR PROPER OPERATION IN THIS CONFIGURATION.
 4. REFER TO MANUFACTURERS' DOCUMENTATION FOR COMPLETE PINOUT AND INTERCONNECT INFORMATION. PINOUTS OF OTHER UNITS SHOWN FOR REFERENCE ONLY.

Figure F-32. Parallel BCD/Slip Code DME Tuning Interconnect
 Page F-65 (Page F-66 blank)
 Rev J