

GNS 480 (CNX80) Color GPS/Nav/Com Installation Manual

September 2004
560-0982-01 Rev A



© 2004 Garmin Ltd. or its subsidiaries. All rights reserved. Printed in the U.S.A.

Garmin International, Inc., 1200 East 151st Street, Olathe Kansas 66062, U.S.A.
Tel: 913/397.8200 Fax: 913/397.8282

Garmin (Europe) Ltd., Unit 5, The Quadrangle, Abbey Park Industrial Estate, Romsey, Hampshire S051
9DL, U.K.
Tel: 44/1794.519944 Fax: 44/1794.519222

Garmin Corporation, No. 68, Jangshu 2nd Road, Shijr, Taipei County, Taiwan
Tel: 886/02.2642.9199 Fax: 886/02.2642.9099

Garmin AT, Inc., 2345 Turner Road, S.E., Salem, OR 97302, U.S.A.
Tel: 800/525.6726 Fax: 503/364.2138
Canada Tel: 800/654.3415
International Tel: 503/391.3411

Cage Code: 0XCJ6

Visit our web pages at <http://www.garminat.com> and <http://www.garmin.com>

Send comments about this manual by email to: techpubs.salem@garmin.com

Except as expressly provided herein, no part of this manual may be reproduced, copied, transmitted, disseminated, downloaded or stored in any storage medium, for any purpose without the express written permission of Garmin. Garmin hereby grants permission to download a single copy of this manual and of any revision to this manual onto a hard drive or other electronic storage medium to be viewed for personal use, provided that such electronic or printed copy of this manual or revision must contain the complete text of this copyright notice and provided further that any unauthorized commercial distribution of this manual or any revision hereto is strictly prohibited.

Information in this document is subject to change without notice. Garmin reserves the right to change or improve their products and to make changes in the content of this material without obligation to notify any person or organization of such changes or improvements.

Garmin®, Garmin AT®, II Morrow, Apollo, and GNS are trademarks of Garmin Ltd. or its subsidiaries. These trademarks may not be used without the express permission of Garmin.

HISTORY OF REVISIONS

Revision	Date	Description
--	07/13/04	Initial release.
A	9/15/04	Regulatory compliance clarification.

ORDERING INFORMATION

To receive additional copies of GNS 480 publications, order the following part numbers:

GNS 480 Installation Manual	560-0982-xx
GNS 480 Pilot Guide	560-0984-xx
GNS 480 Reference Guide	560-0989-xx
GNS 480 Quick Reference Guide	561-0281-xx
GNS 480 Computer-Based Training	560-0990-xx
A-33 GPS Antenna Installation Guide	560-0949-xx
A-34 GPS Antenna Installation Guide	560-5047-xx

List of Effective Pages

Page	Rev	Page	Rev	Page	Rev	Page	Rev	Page	Rev
Cover	01	2-10	01	3-7	01			D-8	01
Copyright	01	2-11	01	3-8	01	5-1	01	D-9	01
i	01	2-12	01	3-9	01	5-2	01	D-10	01
ii	01 A	2-13	01	3-10	01			D-11	01
iii	01	2-14	01	3-11	01			D-12	01
iv	01	2-15	01	3-12	01			D-13	01
v	01	2-16	01	3-13	01	6-1	01	D-14	01
vi	01	2-17	01	3-14	01	6-2	01	D-15	01
		2-18	01	3-15	01 A			D-16	01
		2-19	01	3-16	01			D-17	01
1-1	01	2-20	01	3-17	01	A-1	01	D-18	01
1-2	01	2-21	01	3-18	01	A-2	01	D-19	01
1-3	01	2-22	01	3-19	01			D-20	01
1-4	01	2-23	01	3-20	01			D-21	01
1-5	01	2-24	01	3-21	01	B-1	01	D-22	01
1-6	01	2-25	01	3-22	01	B-2	01	D-23	01
1-7	01	2-26	01	3-23	01	B-3	01	D-24	01
1-8	01	2-27	01	3-24	01	B-4	01	D-25	01
1-9	01	2-28	01	3-25	01	B-5	01	D-26	01
1-10	01	2-29	01	3-26	01	B-6	01	D-27	01
1-11	01	2-30	01	3-27	01	B-7	01	D-28	01
1-12	01	2-31	01	3-28	01	B-8	01	D-29	01
1-13	01	2-32	01	3-29	01	B-9	01	D-30	01
1-14	01	2-33	01	3-30	01	B-10	01	D-31	01
1-15	01 A	2-34	01	3-31	01	B-11	01	D-32	01
1-16	01	2-35	01	3-32	01	B-12	01		
1-17	01	2-36	01	3-33	01	B-13	01		
1-18	01	2-37	01	3-34	01	B-14	01		
1-19	01	2-38	01	3-35	01	B-15	01		
1-20	01	2-39	01	3-36	01	B-16	01		
		2-40	01	3-37	01			E-1	01
2-1	01	2-41	01	3-38	01			E-2	01
2-2	01 A	2-42	01	3-39	01	C-1	01		
2-3	01	2-43	01	3-40	01	C-2	01	F-1	01
2-4	01	2-44	01	3-41	01	C-3	01	F-2	01
2-5	01			3-42	01	C-4	01		
2-6	01			3-43	01				
2-7	01			3-44	01	D-1	01		
2-8	01	3-1	01			D-2	01		
2-9	01	3-2	01			D-3	01		
		3-3	01	4-1	01	D-4	01		
		3-4	01	4-2	01	D-5	01		
		3-5	01	4-3	01	D-6	01		
		3-6	01	4-4	01	D-7	01		

TABLE OF CONTENTS

1	GENERAL INFORMATION.....	1-1
1.1	ABOUT THIS MANUAL	1-1
1.1.1	MANUAL ORGANIZATION.....	1-1
1.1.2	SCOPE.....	1-1
1.2	EQUIPMENT DESCRIPTION.....	1-2
1.2.1	FEATURES.....	1-2
1.2.2	SYSTEM INTERFACES	1-3
1.3	SPECIFICATIONS.....	1-6
1.3.1	ELECTRICAL.....	1-6
1.3.2	PHYSICAL.....	1-6
1.3.3	ENVIRONMENTAL.....	1-6
1.3.4	DISPLAY.....	1-7
1.3.5	GPS/WAAS RECEIVER PERFORMANCE.....	1-7
1.3.6	COMM RECEIVER PERFORMANCE	1-8
1.3.7	COMM TRANSMITTER PERFORMANCE.....	1-8
1.3.8	NAV RECEIVER PERFORMANCE	1-9
1.3.9	AVIONICS INTERFACES.....	1-10
1.3.10	ANTENNA REQUIREMENTS	1-12
1.3.11	SERIAL INTERFACE.....	1-14
1.4	REGULATORY COMPLIANCE.....	1-14
1.4.1	TSO/JTSO AND ADVISORY CIRCULAR REFERENCES.....	1-14
1.4.2	TSO/JTSO AUTHORIZATION.....	1-15
1.4.3	FCC GRANT OF EQUIPMENT AUTHORIZATION	1-15
1.4.4	GNS 480 STC AUTHORIZATION.....	1-15
1.5	DATABASE UPDATES	1-15
1.6	UNPACKING THE EQUIPMENT.....	1-16
1.7	PACKAGE CONTENTS	1-17
1.8	LICENSE REQUIREMENTS	1-18
1.9	DEFINITIONS & ACRONYMS.....	1-19
2	INSTALLATION	2-1
2.1	PRE-INSTALLATION INFORMATION.....	2-1
2.2	INSTALLATION OVERVIEW	2-1
2.3	MATERIALS NOT SUPPLIED	2-1
2.3.1	MATERIALS REQUIRED BUT NOT SUPPLIED	2-1
2.3.2	OPTIONAL ACCESSORIES NOT SUPPLIED	2-2
2.4	SPECIAL TOOLS REQUIRED	2-2
2.5	INSTALLATION CONSIDERATIONS.....	2-2
2.5.1	MINIMUM SYSTEM CONFIGURATION	2-2
2.5.2	EXISTING SENSORS	2-4
2.5.3	MOUNTING CONSIDERATIONS	2-5
2.5.4	CABLING AND WIRING	2-8
2.5.5	AIR CIRCULATION AND COOLING	2-8
2.5.6	COMPASS SAFE DISTANCE	2-8
2.5.7	VIEWING ANGLE	2-8
2.5.8	HELICOPTER INSTALLATION.....	2-8
2.6	EQUIPMENT MOUNTING.....	2-9
2.6.1	MOUNTING TUBE INSTALLATION	2-9
2.6.2	UNIT INSERTION.....	2-12
2.6.3	UNIT REMOVAL	2-13
2.6.4	UNIT REPLACEMENT	2-13
2.7	ELECTRICAL CONNECTIONS.....	2-15
2.7.1	INTERFACE CONNECTOR DEFINITION.....	2-16
2.8	FUNCTIONAL DESCRIPTIONS	2-23
2.8.1	POWER.....	2-23

Table of Contents

2.8.2	MAIN COURSE DEVIATION INDICATOR	2-23
2.8.3	AUXILIARY COURSE DEVIATION INDICATOR	2-25
2.8.4	COMPOSITE INDICATOR	2-26
2.8.5	ALTIMETER	2-26
2.8.6	SYNCHRO HEADING.....	2-26
2.8.7	ANNUNCIATOR OUTPUTS.....	2-27
2.8.8	DISCRETE OUTPUTS.....	2-30
2.8.9	SWITCHES / DISCRETE INPUTS	2-31
2.8.10	SERIAL INTERFACES	2-32
2.8.11	TIME MARK OUTPUT	2-37
2.8.12	VHF COM.....	2-37
2.8.13	VHF NAV.....	2-38
2.8.14	MESSAGE AUDIO	2-39
2.8.15	RMI / OBI.....	2-39
2.8.16	DME TUNING.....	2-40
2.9	ANTENNA INSTALLATION AND CONNECTIONS	2-41
2.9.1	COMM ANTENNA.....	2-41
2.9.2	GPS ANTENNA.....	2-41
2.9.3	NAV ANTENNA.....	2-42
2.10	WEIGHT AND BALANCE.....	2-43
2.11	ELECTRICAL LOAD ANALYSIS	2-43
3	POST INSTALLATION CONFIGURATION & CHECKOUT PROCEDURES.....	3-1
3.1	MOUNTING AND WIRING CHECK	3-1
3.2	EQUIPMENT SETUP AND CONFIGURATION	3-1
3.2.1	SETUP FUNCTION.....	3-2
3.3	EQUIPMENT OPERATIONAL/FUNCTIONAL TEST	3-19
3.3.1	GNS 480 CHECKOUT UTILITIES.....	3-19
3.3.2	SYSTEM CHECKOUT – GROUND CHECKS.....	3-30
3.3.3	SYSTEM CHECKOUT – FLIGHT CHECKS	3-41
3.4	DATABASE CHECK	3-42
3.4.1	DATA CARD REPLACEMENT	3-42
4	TROUBLESHOOTING.....	4-1
4.1	TROUBLESHOOTING PROCEDURE	4-1
4.2	CONTACTING THE FACTORY FOR ASSISTANCE	4-4
5	LIMITATIONS.....	5-1
5.1	OPERATION	5-1
5.2	INSTALLATION.....	5-1
5.2.1	GPS ANTENNA.....	5-1
5.2.2	ANTENNA INSTALLATION – GENERAL	5-1
5.2.3	EQUIPMENT INTERFACED TO THE GNS 480.....	5-1
5.2.4	PRESERVATION OF PREVIOUS SYSTEMS.....	5-2
5.3	AIRCRAFT RADIO STATION LICENSE.....	5-2
6	PERIODIC MAINTENANCE.....	6-1
6.1	EQUIPMENT CALIBRATION	6-1
6.2	VOR CHECKS	6-1
6.3	CLEANING	6-1
6.4	BATTERY REPLACEMENT	6-1
6.5	DISPLAY BACKLIGHT.....	6-1
	APPENDIX A - CERTIFICATION DATA.....	A-1
A.1	ENVIRONMENTAL QUALIFICATION	A-1
A.2	GNS 480 STC DATA.....	A-2
	APPENDIX B - SERIAL INTERFACE SPECIFICATIONS	B-1
B.1	SERIAL INPUT SPECIFICATIONS.....	B-1

B.1.1	ALTITUDE ENCODER/CONVERTER INPUT	B-2
B.1.2	FUEL/AIR DATA COMPUTER INPUT	B-4
B.2	SERIAL OUTPUT SPECIFICATIONS	B-7
B.2.1	MAPCOM OUTPUT	B-7
APPENDIX C - EQUIPMENT COMPATIBILITY		C-1
C.1	ALTITUDE SOURCES.....	C-1
C.2	FUEL/AIR DATA COMPUTERS	C-1
C.3	HEADING SOURCES.....	C-2
C.4	ALTIMETERS FOR BARO CORRECTION	C-2
C.5	AUTOPILOTS	C-2
C.6	ELECTRONIC HSI'S.....	C-3
C.7	TRAFFIC ADVISORY SYSTEMS.....	C-3
APPENDIX D - INTERCONNECT DIAGRAMS.....		D-1
APPENDIX E - ACCEPTABLE AIRCRAFT BY EVALUATION.....		E-1
APPENDIX F – OPTIONAL ACCESSORIES NOT SUPPLIED.....		F-1
F.1	CDI/HSI SOURCE SELECTION ANNUNCIATORS.....	F-1

LIST OF TABLES

TABLE 1-1	- TSO AUTHORIZATION	1-15
TABLE 1-2	- JTSO AUTHORIZATION	1-15
TABLE 1-3	- PACKAGE CONTENTS	1-17
TABLE 1-4	- INSTALLATION KIT CONTENTS (PN 424-2014-800).....	1-17
TABLE 1-5	- HARDWARE KIT CONTENTS (P/N 424-2016-000)	1-18
TABLE 1-6	- OPTIONAL EQUIPMENT AVAILABLE FROM GARMIN AT	1-18
TABLE 2-1	- CRIMP TOOL FOR P/N 162-0082	2-2
TABLE 2-2	- CRIMP TOOL FOR P/N 245-0027	2-2
TABLE 2-3	- INTERFACE CONNECTORS	2-15
TABLE 2-4	- CRIMP CONTACT SPECIFICATIONS	2-15
TABLE 2-5	- MAIN SYSTEM CONNECTOR PIN-OUT (P1)	2-17
TABLE 2-6	- COM I/O CONNECTOR PIN-OUT (P4).....	2-18
TABLE 2-7	- I/O EXPANSION CONNECTOR PIN-OUT (P5).....	2-19
TABLE 2-8	- NAV I/O CONNECTOR PIN-OUT (P7).....	2-22
TABLE 2-9	- ARINC 429 INPUT LABELS	2-34
TABLE 2-10	- ARINC 429 OUTPUT LABELS.....	2-35
TABLE 2-10A11	- ARINC 429 OUTPUT LABELS – CONFIGURATION 5 (ARINC 743A).....	2-37
TABLE 2-12	- UNIT WEIGHTS	2-43
TABLE 2-13	- UNIT POWER LOADS.....	2-43
TABLE 3-1	- SERIAL PORT SETUP CONFIGURATIONS	3-3
TABLE 3-2	- ARINC 429 INPUT AND OUTPUT PORT SETTINGS.....	3-4
TABLE 3-3	- GTX RS-232 SERIAL PORT SETTINGS.....	3-12
TABLE 3-4	- GTX ARINC 429 INPUT AND OUTPUT PORT SETTINGS.....	3-13
TABLE 3-5	- LAMP OUTPUT TEST ITEMS	3-23
TABLE 3-6	- DESCRIPTION OF INPUT MONITOR ITEMS.....	3-29
TABLE 3-7	- GNS 480 POST-INSTALLATION CHECKOUT LOG.....	3-43
TABLE 4-1	- TROUBLESHOOTING GUIDE	4-1
TABLE B- 1	- RS-232 SERIAL INPUT (RX) SELECTIONS	B-1
TABLE B- 2	- ALTITUDE INPUT DATA.....	B-2
TABLE B- 3	- FUEL/AIR DATA MESSAGE DATA (S FORMAT).....	B-4
TABLE B- 4	- FUEL/AIR DATA MESSAGE DATA (Z FORMAT)	B-6

TABLE B- 5 - RS-232 SERIAL OUTPUT (TX) SELECTIONS	B-7
TABLE B- 6 - MOVING MAP ASCII NAVIGATION DATA.....	B-8
TABLE B- 7 - MOVING MAP BINARY ROUTE DATA.....	B-9
TABLE B- 8 - NEAREST WAYPOINT LIST DATA	B-10
TABLE B- 9 - FLIGHT PLAN WAYPOINT TYPE.....	B-11

LIST OF ILLUSTRATIONS

FIGURE 1-1 - GNS 480 COLOR GPS/NAV/COM.....	1-2
FIGURE 1-2 - SAMPLE SINGLE GNS 480 SYSTEM DIAGRAM	1-3
FIGURE 1-3 - SAMPLE DUAL GNS 480 SYSTEM DIAGRAM.....	1-4
FIGURE 2-1 – ACCEPTABLE FIELD-OF-VIEW	2-6
FIGURE 2-2 – ACCEPTABLE CDI/HSI SOURCE SELECTION ANNUNCIATION AREA.....	2-7
FIGURE 2-3 - GNS 480 DIMENSIONS.....	2-11
FIGURE 2-4 - TYPICAL MOUNTING RACK	2-12
FIGURE 2-5 - CAM LOCK POSITIONING	2-13
FIGURE 2-6 - MOUNTING FRAME ASSEMBLY	2-14
FIGURE 2-7 - REAR MOUNTING TUBE CONNECTOR LAYOUT.....	2-16
FIGURE 2-8 - 37-PIN CONNECTOR.....	2-17
FIGURE 2-9 - 15-PIN CONNECTOR.....	2-18
FIGURE 2-10 - 78-PIN CONNECTOR DETAIL.....	2-21
FIGURE 2-11 - REAR COAX CONNECTOR ASSEMBLY	2-42
FIGURE 2-12 - GNS 480 CENTER OF GRAVITY	2-44
FIGURE 3-1 - GROUND MAINTENANCE MODE DISPLAY	3-2
FIGURE 3-2 - SERIAL PORT SETUP PAGE	3-2
FIGURE 3-3 - ARINC 429 PORTS SETUP PAGE	3-4
FIGURE 3-4 - RESOLVER INTERFACE SETUP PAGE.....	3-5
FIGURE 3-5 - RESOLVER CALIBRATION PAGE	3-6
FIGURE 3-6 - ALTIMETER INTERFACE.....	3-7
FIGURE 3-7 - BARO-ALTIMETER CALIBRATION.....	3-7
FIGURE 3-8 - COM RADIO SETUP	3-8
FIGURE 3-9 - MISCELLANEOUS SETUP ITEMS	3-9
FIGURE 3-10 – MEASUREMENT OF GPS VERTICAL OFFSET.....	3-9
FIGURE 3-11 – GPS VERTICAL OFFSET SETUP PAGE	3-10
FIGURE 3-12 - GTX MAIN SETUP PAGE	3-11
FIGURE 3-13 – GTX RS-232 SERIAL SETUP PAGE	3-12
FIGURE 3-14 – GTX ARINC 429 SETUP PAGE (<i>GTX 33/330 ONLY</i>)	3-13
FIGURE 3-15 – GTX AIRCRAFT CONFIGURATION SETUP PAGE	3-14
FIGURE 3-16 – GTX AUDIO SETUP PAGE (<i>GTX 33/330 ONLY</i>)	3-16
FIGURE 3-17 – GTX DIAGNOSTICS PAGE.....	3-18
FIGURE 3-18 - TEST MAIN PAGES	3-19
FIGURE 3-19 - MAIN CDI FLAG TEST	3-20
FIGURE 3-20 – AUXILIARY CDI FLAG TEST	3-20
FIGURE 3-21 – MAIN CDI TEST PAGE	3-21
FIGURE 3-22 – AUXILIARY VDI TEST PAGE.....	3-22
FIGURE 3-23 - LAMP OUTPUT TEST.....	3-23
FIGURE 3-24 - DISPLAY TEST INITIAL SCREEN.....	3-24
FIGURE 3-25 - BEZEL KEY TEST.....	3-25
FIGURE 3-26 - AUTOPILOT TEST.....	3-26
FIGURE 3-27 - INTERFACE MONITOR FUNCTION DISPLAY - PAGE 1.....	3-27
FIGURE 3-28 - INTERFACE MONITOR FUNCTION DISPLAY - PAGE 2.....	3-27
FIGURE 3-29 - INTERFACE MONITOR FUNCTION DISPLAY - PAGE 3.....	3-28

FIGURE 3-30 – GPS INFORMATION START-UP SCREEN.....	3-31
FIGURE 3-31 – GPS STATUS PAGE	3-32
FIGURE B- 1 - ALTITUDE DATA INPUT	B-3
FIGURE B- 2 - FUEL / AIR DATA INPUT (S FORMAT)	B-5
FIGURE B- 3 - MOVING MAP DATA OUTPUT	B-11
FIGURE D- 1 - MAIN POWER AND ANTENNA INTERCONNECT DIAGRAM	D-3
FIGURE D- 2 - MAIN COURSE DEVIATION INDICATOR INTERCONNECT DIAGRAM	D-5
FIGURE D- 3 - AUXILIARY CDI INTERCONNECT DIAGRAM.....	D-7
FIGURE D- 4 - BARO POTENTIOMETER/SYNCRHO HEADING/RMI INTERCONNECT DIAGRAM.....	D-9
FIGURE D- 5 - RS232 SERIAL INTERFACES INTERCONNECT DIAGRAM.....	D-11
FIGURE D- 6 - GNS 480 TO SL10/15 AUDIO PANEL INTERCONNECT DIAGRAM.....	D-13
FIGURE D- 7 - DME TUNING INTERCONNECT DIAGRAM	D-15
FIGURE D- 8 - S-TEC AUTOPILOT INTERCONNECT DIAGRAM	D-17
FIGURE D- 9 - CENTURY AUTOPILOT INTERCONNECT DIAGRAM.....	D-19
FIGURE D- 10 - BENDIX/KING AUTOPILOT INTERCONNECT DIAGRAM.....	D-21
FIGURE D- 11 - SINGLE GNS 480 FULL STACK INTERCONNECT DIAGRAM	D-23
FIGURE D- 12 - FULL STACK WITH DUAL GNS 480'S INTERCONNECT DIAGRAM	D-25
FIGURE D- 13 - GNS 480 TO SANDEL SN3308 NAV DISPLAY INTERCONNECT DIAGRAM.....	D-27
FIGURE D- 14 - GNS 480 TO CDI/HSI SOURCE SELECT ANNUNCIATORS INTERCONNECT DIAGRAM....	D-29
FIGURE D- 15 - GNS 480 TO TRAFFIC SYSTEM AND TRANSPONDER INTERCONNECT DIAGRAM	D-31

NOTES

1 GENERAL INFORMATION

1.1 ABOUT THIS MANUAL

This manual describes the installation and checkout procedures for the GNS 480 Color GPS/Nav/Com. It is intended for use by persons certified by the Federal Aviation Administration (FAA) to install avionics devices.

1.1.1 MANUAL ORGANIZATION

- | | |
|------------|--|
| SECTION 1 | Provides GENERAL INFORMATION about the GNS 480 unit. TSO and JTSO certification information is also included in this section. |
| SECTION 2 | Includes INSTALLATION PROCEDURES . |
| SECTION 3 | Includes POST-INSTALLATION CONFIGURATION AND CHECKOUT . |
| SECTION 4 | Includes TROUBLESHOOTING information. |
| SECTION 5 | Includes LIMITATIONS for the equipment and installation. |
| SECTION 6 | Includes PERIODIC MAINTENANCE requirements. |
| APPENDIX A | Includes CERTIFICATION DATA . |
| APPENDIX B | Includes SERIAL INTERFACE SPECIFICATIONS . |
| APPENDIX C | Includes EQUIPMENT COMPATIBILITY information. |
| APPENDIX D | Includes INTERCONNECT DIAGRAMS . |
| APPENDIX E | Provides a listing of ACCEPTABLE AIRCRAFT BY EVALUATION for those aircraft that have been evaluated by the FAA. |
| APPENDIX F | Provides a listing of OPTIONAL ACCESSORIES NOT SUPPLIED . |

1.1.2 SCOPE

The information in this manual is STC approved. Only the equipment interfaces covered in this manual are within the scope of this STC. Other equipment may be suitable for use with the GNS 480, but use of such equipment is beyond the scope of this STC – additional FAA approval may be required if equipment not covered in this manual is used to interface to the GNS 480.

Antenna installation in the pressure vessel of pressurized aircraft is also beyond the scope of the GNS 480 STC. Additional manufacturer's data may be necessary and FAA approval may be required to cover the installation of the antenna.

Refer to Section 5 Limitations for additional information.

1.2 EQUIPMENT DESCRIPTION

The GNS 480 Color GPS/Nav/Com is a panel-mounted product that contains a GPS/WAAS engine, VHF Comm, and VHF Nav in an integrated unit with a moving map and color display. The GNS 480 will also control a remote transponder.

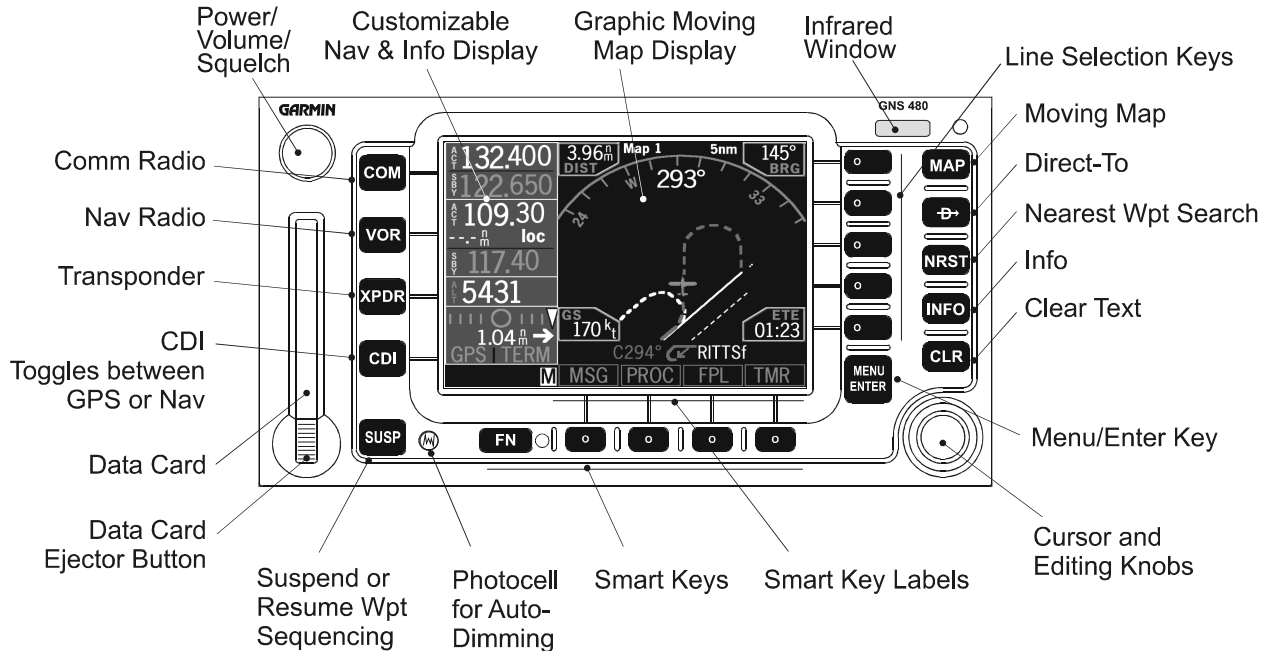

Figure 1-1 - GNS 480 Color GPS/Nav/Com

1.2.1 FEATURES

The features of the GNS 480 Color GPS/Nav/Com include:

- 10-36 VDC Power Capability
- Sunlight-readable 256-color 3.8" diagonal LCD display
- GPS/WAAS engine for state-of-the-art fast, accurate navigation and precision approach (15-channel, 3 WAAS decoders, 5 Hz update of position, time, and velocity, 1 pps output)
- VHF engine for VOR/LOC/GS navigation
- VHF Com with 760 channels and 8 watts transmit power
- Flexible I/O support for RS232, RS422, and ARINC 429
- Control of a remote transponder
- Audio Messages
- Front panel-accessible data card

1.2.2 SYSTEM INTERFACES

The interfaces for a typical single GNS 480 avionics stack are shown in Figure 1-2, while the interfaces for a typical dual GNS 480 avionics stack are shown in Figure 1-3. The available interfaces are further described in the following sections.

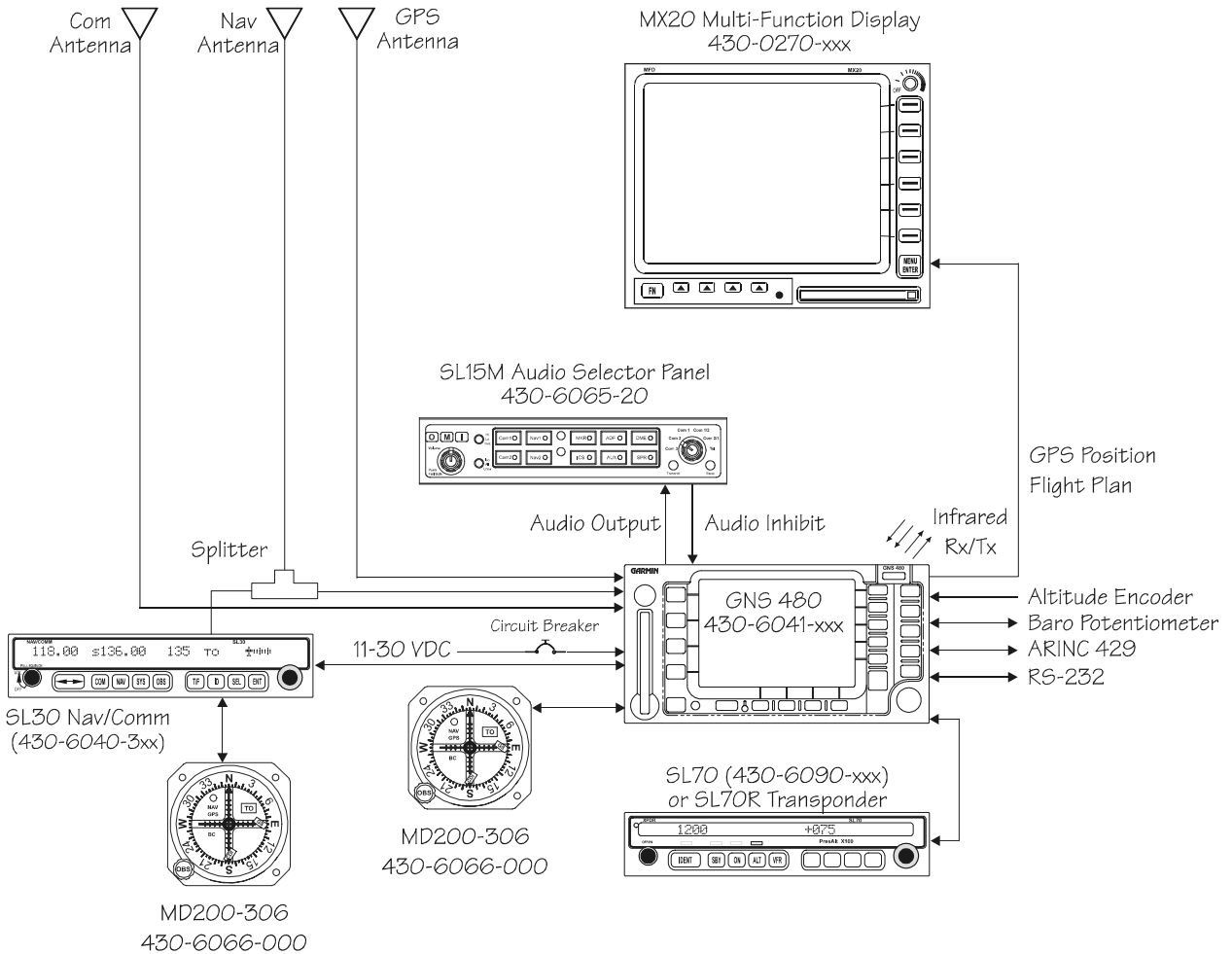

Figure 1-2 - Sample Single GNS 480 System Diagram

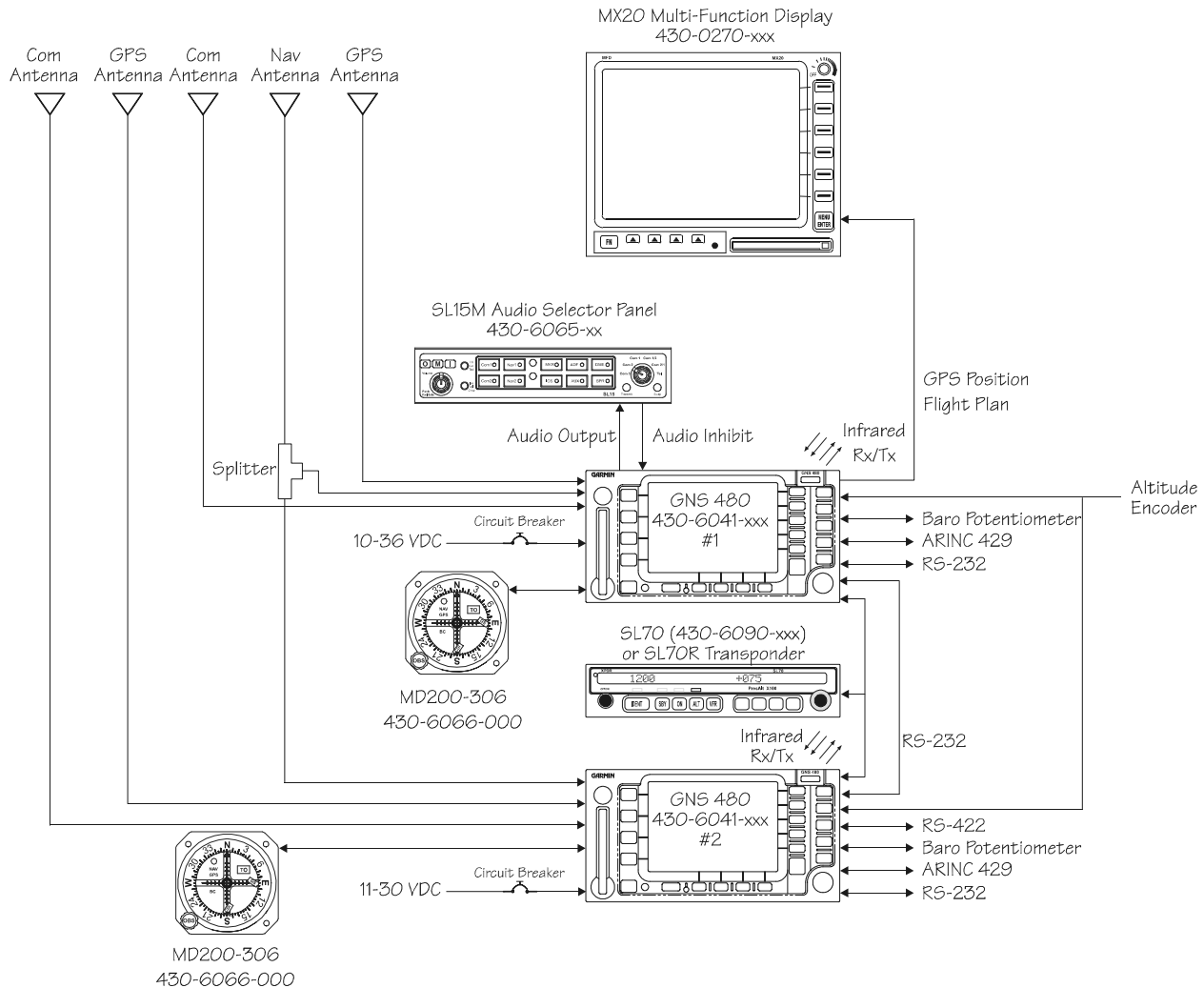

Figure 1-3 - Sample Dual GNS 480 System Diagram

1.2.2.1 CDI

The GNS 480 is capable of driving one external course deviation indicator (CDI) with information based upon VHF Nav or GPS data. The GNS 480 also accepts a resolver input from this CDI. The GNS 480 is capable of driving a second external CDI with information based upon GPS data.

1.2.2.2 Composite Indicator

The GNS 480 is capable of driving an external composite indicator with information based upon VHF Nav data.

1.2.2.3 RMI

The GNS 480 is capable of driving an external RMI (or OBI) navigation indicator with a digital clock / data / sync interface.

1.2.2.4 DME

The GNS 480 can channel a DME based upon the tuned VOR frequency. Currently, the GNS 480 only supports the King Serial DME channeling format.

1.2.2.5 Annunciator Outputs and Switch Inputs

The GNS 480 can drive various external annunciator lamps and receive inputs from various switches to control the GNS 480 operation. This allows for remote operation of the GNS 480 if desired for a specific installation.

1.2.2.6 RS232 Interfaces

The GNS 480 has seven external, user-configurable RS232 serial ports (five are bi-directional, and two are receive-only). The serial ports can be configured to receive RS232 serial data from various sources, including another GNS 480, an SL30, an SL70/SL70R, an MX20, a FADC, an Altitude Encoder, a GTX 33/330 transponder, a GTX 32/327 transponder and a CO Guardian (COG) carbon monoxide sensor. These ports can also be configured to transmit RS232 serial data in various formats, including MAPCOM. These outputs allow the GNS 480 to transmit data to the MX20, SL30, SL70/SL70R, GTX 33/330 and GTX 32/327. In addition, the GNS 480 can transmit data to any unit that accepts the standard Garmin AT MAPCOM data.

1.2.2.7 RS422 Interfaces

The GNS 480 has one user-configurable, bi-directional RS422 port. This port is not currently used.

1.2.2.8 ARINC 429 Interfaces

The GNS 480 has three ARINC 429 input ports and two ARINC 429 output ports. Each port is user-configurable for low or high speed operation. The GNS 480 can be set up to receive air data, heading data, wind data or traffic data from suitable equipment. The outputs can be set up to output ARINC 429 data in various formats.

1.2.2.9 Baro Correction Input

The GNS 480 has one interface that allows a baro correction potentiometer to be connected directly to the GNS 480. This input can be calibrated at installation, allowing a wide variety of altimeters to be connected to the GNS 480.

1.2.2.10 Synchro Input

The GNS 480 has one XYZ synchro input that allows synchro heading to be supplied to the GNS 480.

1.2.2.11 Message Audio Output

The GNS 480 has one 500 Ω audio output that can be connected to an audio panel to provide audible messages to the pilot. This output can be automatically inhibited by other equipment if required.

1.2.2.12 Infrared Interface

The GNS 480 has one user-configurable bi-directional infrared port. This port is not currently used but in the future will be used to send and receive flight plan and user waypoint information through a PDA that has infrared capabilities.

1.3 SPECIFICATIONS

This section includes detailed electrical, physical, environmental and performance specifications for the GNS 480.

1.3.1 ELECTRICAL

Input voltage.....	10 VDC to 36 VDC
Input current (Main input – P1)	1.4 A typical, 2.2 A max (heater off) at 14 VDC 2.4 A typical, 3.2 A max (heater on) at 14 VDC 700 mA typical, 1.1 A max (heater off) at 28 VDC 1.2 A typical, 1.6 A max (heater on) at 28 VDC <i>Note: backlight heater element turns on when internal temperature is below approx. 42 °C</i>
Input current (VHF Nav input – P7)	450 mA typical, 700 mA max at 14 VDC 200 mA typical, 350 mA max at 28 VDC
Input current (Comm input – P4).....	270 mA typical, 350 mA max at 14 VDC, receive 130 mA typical, 175 mA max at 28 VDC, receive 2.1 A typical, 3.2 A max at 14 VDC, transmit 1.0 A typical, 1.6 A max at 28 VDC, transmit <i>Note: receive max at full receive audio, transmit max at 90% modulation at 1000 Hz.</i>
Internal fuses	Main input: 3 amp fast-blow, socketed on board (2) Nav input: 3 amp fast-blow, socketed on board Comm input : 7 amp fast-blow, soldered in board
Memory backup	Internal flash memory

1.3.2 PHYSICAL

Height.....	3.3 inches (84 mm)
Width.....	6.25 inches (159 mm)
Depth.....	11.7 inches (297 mm) (behind panel, including mounting frame and connectors)
Weight.....	5.8 lbs. (2.6 kg) unit only 0.7 lbs. (0.3 kg) mounting tube

1.3.3 ENVIRONMENTAL

The GNS 480 unit is designed and tested to meet appropriate categories as shown in the Environmental Qualification Form included in Appendix A.

Operating temperature.....	-20°C to +55°C
Storage temperature	-55°C to +85°C
Temperature variation.....	2°C per minute
Humidity	95% at 50°C
Maximum continuous altitude	35,000 feet

Decompression	55,000 feet (operation for up to 30 minutes at 55,000 feet supported)
Cooling	Not required

1.3.4 DISPLAY

TSO/JTSO Compliance	TSO-C113 (SAE/AS8034)/JTSO-C113
Active Display Size	3.8" Diagonal (3.1" (W) x 2.1"(H))
Display Format	320 pixels (W) x 240 pixels (H)
Viewing Angle (with 5:1 contrast ratio min.)	
Left/Right.....	60° from perpendicular
Up	60° from perpendicular
Down	35° from perpendicular
Brightness	
Maximum.....	130 fL
Minimum	0.2 fL (at zero ambient light)
* Minimum brightness can be adjusted by the user to a value > 0.2 fL	

1.3.5 GPS/WAAS RECEIVER PERFORMANCE

TSO/JTSO Compliance	TSO-C146a (RTCA/DO-229C)/JTSO-C146
Number of channels.....	15 (12 GPS and 3 GPS/WAAS/SBAS)
Frequency	1575.42 MHz L1, C/A code
Sensitivity (acquisition).....	-116 dBm to -134.5 dBm GPS -116 dBm to -135.5 dBm WAAS
Sensitivity (drop lock)	-144 dBm
Dynamic range.....	> 20 dB
Lat/Long position accuracy	<1 meter RMS typical with WAAS (horizontal/vertical)
Velocity	1000 knots maximum (above 60,000 ft)
TTF (time to first fix).....	1:45 min. typical with current almanac, position, and time
Reacquisition	10 seconds typical
Position update interval	0.2 sec (5 Hz)
1 pps (pulse per second)	±275 nsec of UTC second
Datum	WGS-84
SATCOM compatibility	Compatible on aircraft equipped with SATCOM
Antenna power supply	35 mA typical, 40 mA max at 4.7 VDC

1.3.6 COMM RECEIVER PERFORMANCE

TSO/JTSO Compliance.....	TSO-C38d (RTCA/DO-186, DO-186a)/JTSO-2C38e
Class	D
Frequency range.....	118.000 to 136.975 MHz, 760 channels
Sensitivity.....	1 μ V (2 μ V hard) for 6dB S+N/N with 30% modulation at 1000Hz
Selectivity.....	< 6dB variation at \pm 7 kHz, > 60dB at \pm 22 kHz
Speaker audio output level.....	12 watts into 4 Ω , 8 watts into 8 Ω
Headphone audio output level.....	280 mW into 100 Ω , 120mW into 500 Ω
Distortion	< 5% at rated output at 1000 Hz
AGC characteristics	< 3 dB variation in audio output from 5 μ V to 100mV input, 15% to 90% modulation
Squelch control	Automatic squelch with manual override

1.3.7 COMM TRANSMITTER PERFORMANCE

TSO/JTSO Compliance.....	TSO-C37d (RTCA/DO-186, DO-186a)/JTSO-2C37e, TSO-C128 (RTCA/DO-207)/JTSO-2C128
Class	4
Output power.....	8 watts minimum carrier at >12 VDC input, 6 watts minimum at 10 VDC input (transmit is locked out below 9 volts input)
Frequency range.....	118.000 to 136.975 MHz, 760 channels
Frequency tolerance	\pm 15 ppm from -20 $^{\circ}$ C to +70 $^{\circ}$ C
Microphone input.....	Two inputs, standard carbon or dynamic mic with integrated preamp providing minimum 70mV rms into 1000 Ω load
Modulation capability	85% with 100mV to 1000mV rms microphone input at 1000 Hz
Audio frequency distortion	< 10% at 85% modulation at 350 to 2500 Hz
Audio frequency response.....	< 4 dB variation with 350 to 2500 Hz, 85% modulation
Carrier noise level	> 35 dB down
Sidetone output	up to 280 mW into 100 Ω , 120 mW into 500 Ω
Duty cycle:	100%
Stuck mic time-out	35 second time-out, reverts to receive

1.3.8 NAV RECEIVER PERFORMANCE

1.3.8.1 VOR

TSO/JTSO compliance	TSO-C40c (RTCA/DO-196)/JTSO-2C40
Operational class	N/A
Accuracy category	B { -46°C to + 55°C }
Frequency range.....	108.00 to 117.95 MHz in 50 kHz increments
Frequency tolerance.....	0.0008%
Cross modulation products	At least 60 dB down
Receiver sensitivity.....	108 MHz -115 dBm typical 117 MHz -117 dBm typical
Course accuracy.....	RTCA DO-196 two sigma limit: 3° GNS 480 performance: less than 0.5° typical
Audio output	With a 1 kHz tone 30% modulation at least 100 mW output into 500 Ω loads
Ident/voice	With 100 mV input, 30% modulation at 1020 Hz, the ident/voice tone ratio shall not be less than 15 dB
Audio response	Less than 6 dB variation from 350 Hz to 2500 Hz

1.3.8.2 Localizer

TSO/JTSO compliance	TSO-C36e (RTCA/DO-195)/JTSO-C36e
Operational class	A { manual landing systems }
Accuracy category	B { -46°C to + 55°C }
Frequency range.....	108.00 to 111.95 MHz
Frequency tolerance.....	0.0008%
Cross modulation products	At least 60 dB down
Receiver sensitivity.....	-115 dBm typical
Centering error.....	RTCA DO-195 two sigma limit: 6.6% of full scale GNS 480 performance: less than 1.0% typical (1.5 mV)
Audio output	With a 1 kHz tone 30% modulation at least 100 mW output into 500 Ω loads
Ident/voice	With 100 mV input, 30% modulation at 1020 Hz, the ident/voice tone ratio shall not be less than 15 dB
Audio response	Less than 6 dB variation from 350 Hz to 2500 Hz

1.3.8.3 Glideslope

TSO/JTSO compliance	TSO-C34e (RTCA/DO-192)/JTSO-C34e
Operational class	N/A
Accuracy category	B { -46°C to + 55°C }

Frequency range	329.150 to 335.00 MHz
Frequency tolerance	0.0008%
Cross modulation products.....	At least 60 dB down
Receiver sensitivity	-95 dBm typical
Centering error	RTCA DO-195 two sigma limit: 6.7% of full scale GNS 480 performance: less than 2.0% typical (3.0 mV)

1.3.8.4 Computation Rates

The tuned active frequency is computed 10 times per second. If the VOR monitor function is activated, 20% of each second is allocated to the monitored frequency, slightly decreasing the active to frequency computation rate. It is important to note that the monitored frequency is only updated once per second.

1.3.9 AVIONICS INTERFACES

1.3.9.1 Main CDI (GPS or VHF Nav)

1.3.9.1.1 Deviations / Flags / Annunciators

CDI L/R deviation.....	±150 mv full scale (200 Ω load max)
TO/OFF/FROM flag	±250 mv, TO/FROM (200 Ω load max)
Nav valid flag.....	+300 mv for valid indication (200 Ω load max)
Nav superflag	V _{in} - 2 volts (minimum) for valid, source capability of 400 mA
VDI up/down.....	±150 mv full scale (200 Ω load max)
VDI valid flag	+300 mv for valid indication (200 Ω load max)
VDI superflag.....	V _{in} - 2 volts (minimum) for valid, source capability of 400 mA
GPS/Nav Annunciators	Open collector outputs capable of sinking up to 400 mA for turning ON annunciator lamps

1.3.9.1.2 OBS Resolver

TSO/JTSO compliance	TSO-C40c (DO-196)/JTSO-2C40
Applicable documents.....	RTCA DO-196
Operational class.....	N/A
Accuracy category.....	B {-46°C to + 55°C}
Output signal	300 Hz ± 2 Hz (rounded square wave)
Output voltage (automatically adjusted during calibration)	5 V _{pp} to 10 V _{pp}
Input voltage max (calibrated)	5 V _{pp} (when OBS is set to maximum)
Resolver voltage gain (loss).....	1:1 maximum, 2:1 minimum
Output loading at max voltage	100 ohms impedance
Accuracy/Resolution.....	0.25° rounded to 1° steps

1.3.9.2 Auxiliary CDI (GPS Only)

CDI L/R deviation	±150 mv full scale (200 Ω load max)
TO/OFF/FROM flag	±250 mv, TO/FROM (200 Ω load max)
Nav valid flag	+300 mv for valid indication (200 Ω load max)
VDI up/down	±150 mv full scale (200 Ω load max)
VDI valid flag	+300 mv for valid indication (200 Ω load max)

1.3.9.3 Composite Output

1.3.9.3.1 VOR Mode

Band pass frequency	0 Hz to 15 kHz
Variation over frequency range	Less than 2 dB
Output signal voltage	0.500 VRMS
Output loading	1,000 ohms (max)

1.3.9.3.2 LOC Mode

Band pass frequency	0 Hz to 15 kHz
Variation over frequency range	Less than 2 dB
Output signal voltage	0.390 VRMS (0.275 VRMS @ 90 Hz, 0.275 VRMS @ 150 Hz)
Output loading	1,000 ohms (max)
ILS energize signal	Sinks up to 400 mA (max)

1.3.9.4 Annunciator Outputs

Annunciators	Open collector outputs capable of sinking up to 400 mA for turning ON annunciator lamps
--------------------	---

1.3.10 ANTENNA REQUIREMENTS

1.3.10.1 GPS Antennas

1.3.10.1.1 A-33 (590-1104)

Early production runs of PN 590-1104 were marked with TSO-C129a. This antenna was re-qualified to TSO-C144 with no changes to the antenna. P/N 590-1104 antennas marked with TSO-C129a identification are identical to those marked with TSO-C144.

Applicable TSO: TSO-C144 (RTCA/DO-228 with Change No. 1)

Frequency: 1575 MHz

Polarization: Right Hand Circular

Axial Ratio: 3 dB Max at bore site

Radiation Coverage:	Elevation Angle	Minimum Gain
	>15°	-2.0 dBic
	10°	-3.0 dBic
	5°	-4.5 dBic
	0°	-7.5 dBic

Finish: Polyurethane Enamel

Weight: 3.9 oz. (0.11 kg)

Height: 0.61 inches (1.55 cm)

Operating Temperature: -55°C to +85°C

Operating Altitude: 55,000 feet (16,764m) max.

Amplifier:

Gain 26.5 dB \pm 2 dB

Noise Figure: 2.5 dB Max

Impedance: 50 ohms

VSWR (Dry): \leq 1.5:1

VSWR (Rain): \leq 2.0:1

Band Rejection: 35 dB

Power Handling: 1 Watt

Voltage: 5 VDC \pm 10%

Current: 35 mA nominal, 40 mA max.

L1 Filter Bandwidth 1575 \pm 20 MHz (3 dB)
+110, -210 MHz (60dB)

Group Delay (3dB bandwidth) 27 \pm 10 nanosecond

Pass Band Ripple (3dB bandwidth) 0.2 dB max

1.3.10.1.2A-34 (590-1112)

Early production runs of PN 590-1112 were marked with TSO-C129a. This antenna was re-qualified to TSO-C144 with no changes to the antenna. P/N 590-1112 antennas marked with TSO-C129a identification are identical to those marked with TSO-C144.

Applicable TSO:TSO-C144 (RTCA/DO-228 with Change No. 1)

Frequency:1575 MHz

Polarization:Right Hand Circular

Axial Ratio:3 dB Max at bore site

Radiation Coverage:	Elevation Angle	Minimum Gain
	>15°	-2.0 dBic
	10°	-3.0 dBic
	5°	-4.5 dBic
	0°	-7.5 dBic

Finish:Polyurethane Enamel

Weight:7.0 oz. (0.2 kg)

Height:0.66 inches (1.76 cm)

Operating Temperature:-55°C to +85°C

Operating Altitude:55,000 feet (16,764m) max.

Amplifier:

Gain26.5 dB ±2 dB

Noise Figure:2.5 dB Max

Impedance:50 ohms

VSWR (Dry):≤ 1.5:1

VSWR (Rain):≤ 2.0:1

Band Rejection:35 dB

Power Handling:1 Watt

Voltage:5 VDC ±10%

Current:35 mA nominal, 40 mA max.

L1 Filter Bandwidth.....1575 ±20 MHz (3 dB)
+110, -210 MHz (60dB)

Group Delay (3dB bandwidth).....27 ±10 nanosecond

Pass Band Ripple (3dB bandwidth)0.2 dB max

1.3.10.2 Comm Antenna

The GNS 480 requires a VHF comm antenna meeting the following specifications:

- Standard 50Ω vertically polarized antenna with a VSWR < 2.5:1
- TSO C37d, and TSO C38d

1.3.10.3 VHF Antenna

The GNS 480 requires a VHF NAV antenna meeting the following specifications:

- Standard 50 Ω horizontally polarized antenna with a VSWR < 3:1
- Capable of receiving VOR/LOC/GS (Such as: Comant Industries P/N CI 157P)
- 108.00 – 117.95 MHz (VOR/LOC)
- 328.60 – 335.4 MHz (GS)
- TSO C34e, TSO C36e, and TSO C40c

1.3.11 SERIAL INTERFACE

RS-232 Defined in Appendix B- Serial Interface Specifications

1.4 REGULATORY COMPLIANCE

1.4.1 TSO/JTSO AND ADVISORY CIRCULAR REFERENCES

- TSO-C34e/JTSO-C34e, ILS Glide Slope Receiving Equipment Operating Within the Radio Frequency Range of 328.6-335.4 Megahertz (MHz)
- TSO-C36e/JTSO-C36e, Airborne ILS Localizer Receiving Equipment Operating Within the Radio Frequency Range of 108-112 Megahertz (MHz)
- TSO-C37d/JTSO-2C37e, VHF Radio Communications Receiving Equipment Operating Within the Radio Frequency Range 117.975 to 137.000 Megahertz
- TSO-C38d/JTSO-2C38e Class D, VHF Radio Communications Transmitting Equipment Operating Within the Radio Frequency Range 117.975 to 137.000 Megahertz
- TSO-C40c/JTSO-2C40, VOR Receiving Equipment Operating Within the Radio Frequency Range of 108-117.95 Megahertz (MHz)
- TSO-C113/JTSO-C113, Airborne Multipurpose Electronic Displays
- TSO-C128/JTSO-2C128, Devices That Prevent Blocked Channels Used in Two-Way Radio Communications Due to Unintentional Transmission
- TSO-C146a/JTSO-C146 Class 3, Stand-Alone Airborne Navigation Equipment using the Global Positioning System (GPS) Augmented by the Wide Area Augmentation System (WAAS)
- AC 20-67B, Airborne VHF Communications Equipment Installations
- AC43.13-1B, Acceptable Methods, Techniques and Practices - Aircraft Inspection and Repair
- AC43.13-2A, Acceptable Methods, Techniques and Practices - Aircraft Alterations

NOTE

Unauthorized changes or modifications to the GNS 480 may void the compliance to required regulations and authorization for continued equipment usage.

All GNS 480 (CNX80) functions are design approved by TSO or JTSO, and have airworthiness approval as part of the initial STC. If additional information (drawing lists and software documentation) is required for aircraft installation certification, contact Garmin AT Customer Support for assistance.

1.4.2 TSO/JTSO AUTHORIZATION

Table 1-1 - TSO Authorization

Function	TSO	Minimum Performance Standard	Software RTCA/DO-178B
Com	TSO-C37d, Transmitter, 100nm range TSO-C38d, Receiver TSO-C128, Stuck Mic	RTCA/DO-186A, Class 4, RTCA/DO-186A, Class D RTCA/DO-207	Level C
VOR/ILS	TSO-C34e, Glideslope TSO-C36e, Localizer TSO-C40c, VHF Omni Range	RTCA/DO-192, Cat B RTCA/DO-195, Cat A RTCA/DO-196, Cat B	Level C
GPS/WAAS	TSO-C146a, GPS/WAAS	RTCA/DO-229C, Class 1	Level B
MFD	TSO-C113, Display	SAE AS 8034	Level B

Table 1-2 - JTSO Authorization

Function	JTSO	Minimum Performance Standard	Software ED-12B
Com	JTSO-2C37e, Transmitter, 100nm range JTSO-2C38e, Receiver JTSO-2C128, Stuck Mic	EUROCAE/ED-23B EUROCAE/ED-23B EUROCAE/ED-67	Level C
VOR/ILS	JTSO-C34e, Glideslope JTSO-C36e, Localizer JTSO-2C40, VHF Omni Range	EUROCAE/ED-47A EUROCAE/ED-46A EUROCAE/ED-22B	Level C
GPS/WAAS	JTSO-C146, GPS/WAAS	RTCA/DO-229C, Class 1	Level B
MFD	JTSO-C113, Display	SAE AS 8034	Level B

1.4.3 FCC GRANT OF EQUIPMENT AUTHORIZATION

- FCC ID: EOJ52ICOM96

1.4.4 GNS 480 STC AUTHORIZATION

Refer to Garmin AT document 560-0988-00 for data regarding GNS 480 STC authorization.

1.5 DATABASE UPDATES

The GNS 480 utilizes a database stored on a CompactFlash Memory datacard for easy updating and replacement. The database is updated by simply inserting an updated database card into the slot in the front panel in the GNS 480.

The GNS 480 comes with a CompactFlash memory card reader/writer (R/W). The R/W is intended for updating the included database card using a PC. Refer to the installation manual included with the R/W for instructions on how to install and operate the CompactFlash R/W.

The database on the GNS 480 database card is generated from current Jeppesen-Sanderson data and converted to a format that is used by the GNS 480. The data conversion process is performed using software that is developed and maintained under Garmin AT configuration management according to RTCA/DO-200A, Standards for Processing Aeronautical Data.

GNS 480 users update their database card by purchasing database subscription updates from Jeppesen-Sanderson. The database card is programmed using the supplied CompactFlash memory card R/W and Jeppesen-provided software. Contact Jeppesen at 800-621-5377 or www.jeppesen.com for more information and instructions.

Contact Garmin AT, Inc. for information on databases available for the GNS 480.

CAUTION

Do not insert or remove the data card within 10 seconds after the GNS 480 is turned on.

1.6 UNPACKING THE EQUIPMENT

Carefully unpack the equipment. Visually inspect the package contents for any evidence of shipping damage. Retain all shipping containers and packaging material in case reshipment is necessary.

1.7 PACKAGE CONTENTS

As shipped from the Garmin AT factory, the GNS 480 package includes most necessary items for installation other than supplies normally available at the installation shop, such as wire and cable ties, circuit breakers, and required input and output equipment. The items included in the package are listed in Table 1-3, Table 1-4, and Table 1-5. Optional items available are listed in Table 1-6.

Table 1-3 - Package Contents

Item	Qty	Description
138-0329-xxx	1	GNS 480 Worldwide Database Card
140-0056-xxx	1	GNS 480 Product CD <i>(includes the following)</i> 560-0949-xx A33 GPS Antenna Installation Guide 560-0982-xx GNS 480 Installation Manual 560-0988-xx GNS 480 STC Data 560-5047-xx A34 GPS Antenna Installation Guide and other pilot-related items
140-0060-xxx	1	GNS 480 / MX20 In-Flight Demo DVD
140-0061-xxx	1	GNS 480 Promotional CD
424-2014-8xx	1	GNS 480 Installation Kit (see Table 1-4 for detail)
424-2016-xxx	1	GNS 480 Hardware Kit (See Table 1-5 for detail)
428-0059	1	CompactFlash Card Reader, USB
430-6100-8hh-sss	1	GNS 480 WAAS/GPS Nav Com <i>(hh defines hardware configuration and sss defines software configuration)</i>
560-0984-xx	1	GNS 480 Pilot's Guide
561-0281-xx	1	GNS 480 Quick Reference Guide
590-1104	1	A33 GPS Antenna

Table 1-4 - Installation Kit Contents (PN 424-2014-800)

Item	Qty	Description
162-0082	50	22-28 AWG male crimp contact
162-0109	1	78 Pin Crimp Hi Density D-Sub Plug
162-1008	3	Coax Plug, right angle mount
162-1575	1	15 Pin Crimp D-Sub Receptacle
162-1577	2	37 Pin Crimp D-Sub Receptacle
310-3071-02	1	Mounting Tube, GNS 480
310-3072-00	1	Air Deflector, GNS 480
310-3073-00	1	Connector plate GNS 480
204-0037	0.5 ft	.062 Black Flexible Grommet
245-0027	60	20-24 AWG female crimp contact

Table 1-5 – Hardware Kit Contents (P/N 424-2016-000)

Item	Qty	Description
221-0400	8	4-40 X 1/4 SS PHP screw with washer
224-0404	22	4-40 x 1/4 82 Deg SS FHP Screw
240-0425	6	#4 SS Flat washer
251-9615-00	6	Standoff .250sq X .502 long X.075
Note: Hardware Kit items may optionally be provided loose as part of the Installation Kit.		

Table 1-6 - Optional Equipment Available from Garmin AT

Item	Description
115-0007	Splitter, 2-way, 50 Ω, BNC (NAV/VOR/Localizer/Glideslope)
162-0098	Coax Plug, straight mount with BNC female
162-1059	Notch Filter, 1575 MHz, BNC Male/Female
590-1112	A34 GPS Antenna

1.8 LICENSE REQUIREMENTS

An aircraft radio station license is not required when operating in U.S. airspace, but may be required when operating internationally.

1.9 DEFINITIONS & ACRONYMS

ADC	Air Data Computer
ALT	Altitude
APPR	Approach
COM	VHF Communication
DDM	Differential Depth of Modulation
DP	Departure Procedure
EN	Engineering Notice
FADC	Fuel/Air Data Computer
GPS	Global Positioning System
ILS	Instrument Landing System
JTSO	Joint Technical Standard Order
LAAS	Local Area Augmentation System
LCD	Liquid Crystal Display
LNAV	Lateral Navigation
LOC	Localizer
MFD	Multi-Function Display
NAV	VHF Navigation
NDB	Non-Directional Beacon
OBS	Omni-Bearing Selector
PDA	Personal Digital Assistant
PTK	Parallel Track
SDI	Source Destination Identifier
SID	Standard Instrument Departure
STAR	Standard Terminal Arrival Route
STC	Supplementary Type Certificate
TFR	Temporary Flight Restriction
TSO	Technical Standard Order
VDI	Vertical Deviation Indicator
VNAV	Vertical Navigation
VOR	Very High Frequency Omni-Directional Range
WAAS	Wide Area Augmentation System
XPDR	Transponder

NOTES

2 INSTALLATION

This section describes the installation of the GNS 480 including mounting, wiring, and connections. Post-Installation configuration and checkout procedures are included in section 3.

2.1 PRE-INSTALLATION INFORMATION

Always follow acceptable avionics installation practices per FAA Advisory Circulars (AC) 43.13-1B, 43.13-2A, or later FAA approved revisions of these documents.

Follow the installation procedure in this section as it is presented for a successful installation. Read the entire section before beginning the procedure. Prior to installation, consider the structural integrity of the GNS 480 installation as defined in AC 43.13-2A, Chapter 1. Perform the post installation checkout before closing the work area in case problems occur.

Complete an electrical load analysis in accordance with AC 43.13-1B, Chapter 11, on the aircraft prior to starting modification to ensure aircraft has the ability to carry the GNS 480 load. Refer to Section 2.11 for the power consumption of each GNS 480 mode of operation. Document the results of the electrical load analysis on FAA Form 337.

The WAAS/GPS installation instructions have been prepared to meet the guidance material defined in AC20-138A Final Draft Airworthiness Approval of Global Navigation Satellite System (GNSS) Equipment. The communications installation instructions have been prepared to meet the guidance material defined by AC 20-67B Airborne VHF Communications Equipment Installations.

2.2 INSTALLATION OVERVIEW

A successful installation should start with careful planning, including determination of mounting location for the GNS 480, cable routing, and other required modifications. Once the mounting location has been determined, prepare the mounting tube for installation. It may be easier to complete the wiring harness and attach the connectors to rear connector plate before attaching it to the mounting tube.

Carefully plan which external devices will be connected to the GNS 480 inputs.

2.3 MATERIALS NOT SUPPLIED

2.3.1 MATERIALS REQUIRED BUT NOT SUPPLIED

The GNS 480 is intended for use with standard aviation accessories. The following items are required for the installation, but not supplied:

- Wire (MIL-W-22759/16 or equivalent)
- Shielded wire (MIL-C-27500 or equivalent)
- Mounting screws (8 min. - AN507 6-32 screw with 100° countersink,)
- Circuit breakers
- Antennas (other than the A-33 GPS antenna supplied in the kit)
- Tie wraps or lacing cord
- Ring terminals (for grounding)

2.3.2 OPTIONAL ACCESSORIES NOT SUPPLIED

For a list of optional accessories that are available but not supplied with the GNS 480, refer to Appendix F.

2.4 SPECIAL TOOLS REQUIRED

Some of the connectors use crimp contacts. The tables below identify crimp tools required to ensure consistent, reliable crimp contact connections for the rear D-sub connectors. The tables define one source for the crimp tool. Alternate equivalent tools may be used.

Table 2-1 - Crimp Tool for P/N 162-0082

Description	ITT/Cannon P/N	Military number
Insertion/Extraction tool CIET-22D	271-7048-000	M81969/14-01
Crimp tool	995-0001-584	M22520/2-01
Positioner	N/A	M22520/2-09

Table 2-2 - Crimp Tool for P/N 245-0027

Description	ITT/Cannon P/N	Military number
Insertion/Extraction tool CIET-20HD	980-200-426	M81969/39-01
Crimp tool	995-0001-584	M22520/2-01
Positioner	995-0001-604	M22520/2-08

Below is the contact for ITT/Cannon crimp tools:

ITT Cannon	Phone (714) 557-4700 or 1-800-854-3028
666 E. Dyer Road	FAX (714) 628-2142
Santa Ana, CA 92705-5612	

2.5 INSTALLATION CONSIDERATIONS

Installation of this STC does not change the types of approved airplane operations as defined by FAR 23.1525 (e.g. IFR, VFR, day or night). If a change in approved operations is desired, additional aircraft approvals or inspections will be required.

2.5.1 MINIMUM SYSTEM CONFIGURATION

2.5.1.1 VFR Installation

The minimum GNS 480 installation requires the following items for a VFR Installation:

- GNS 480 GPS/WAAS/Nav/Com (installed in the aircraft manufacturer approved location)
- GPS antenna, Nav antenna and Com antenna.
- To take full advantage of the GNS 480 capabilities an optional altitude source is recommended for automatic sequencing of course-to-altitude (CA) and heading-to-altitude (VA) leg types. If no altitude data is provided to the GNS 480, CA and VA legs must be manually sequenced.

Without an external CDI, no glideslope information is obtainable. However, the unit will maintain full VOR and Localizer functionality including an internal CDI display.

The installation must be placarded “GPS LIMITED TO VFR USE ONLY” in clear view of the pilot.

2.5.1.2 IFR VOR/LOC/GS Installation

The minimum GNS 480 installation requires the following items for an IFR VOR/LOC/GS Installation:

- GNS 480 GPS/WAAS/Nav/Com (installed in the aircraft manufacturer approved location)

- GPS antenna, Nav antenna and Com antenna.
- External CDI/HSI indicator installed in the pilot’s primary field-of-view (or in the aircraft manufacturer approved mounting location). This indicator must meet the following criteria:
 1. The course deviation needle shall have a full-scale deflection with a 150 mV deviation input.
 2. The valid flag shall be either a low-level input or superflag input.
 3. The TO/FROM flag shall be fully in view with a 250 mV input.
 4. The OBS resolver should be compatible with a standard 6-wire OBS interface:

H	Reference output high	E.....	S3 COS input low
C.....	Reference output low	F.....	S4 SIN input high
D	S1 COS input high	G	S2 SIN input low

Any electrical zero crossing will work because the GNS 480 will calibrate out any errors.

- External non-numeric glideslope indicator installed in the pilot’s primary field-of-view. This indicator must meet the following criteria:
 1. The glideslope deviation needle shall have a full-scale deflection with a 150 mV deviation input.
 2. The valid flag shall be either a low-level input or superflag input.

NOTE
 Exact specifications for the external CDI/HSI and glideslope indicator interfaces are found in 1.3.9 Avionics Interfaces.

- CDI/HSI source selection annunciator (only required for some installations – refer to 2.5.3.2 for additional information describing when a source selection annunciator is required).
- To take full advantage of the GNS 480 capabilities an optional altitude source is recommended for automatic sequencing of course-to-altitude (CA) and heading-to-altitude (VA) leg types. If no altitude data is provided to the GNS 480, CA and VA legs must be manually sequenced.

2.5.1.3 IFR GPS Installation

In order for the GNS 480 to be utilized for IFR GPS Navigation, the criteria in 2.5.1.2 must be met **and** the GNS 480 must be mounted within the acceptable field-of-view. Refer to 2.5.3.1 for determining whether or not the GNS 480 is located within the acceptable field-of-view.

In certain instances, aircraft on the Approved Model List have a center radio stack located outside of the acceptable field-of-view. These installations may only be approved for IFR operations under the AML if the location has been previously approved by the FAA (ACO). Refer to Appendix E for a list of aircraft that do not meet the acceptable field-of-view requirement above but have been evaluated by the FAA and determined to be acceptable.

NOTE

If the GNS 480 installation is outside the acceptable field-of-view and the aircraft type is not listed in Appendix E it does not mean that the installation is unacceptable – the FAA has not yet evaluated it. The installation can be completed and the aircraft returned to service pending an FAA evaluation of the installation, provided it is placarded “GPS LIMITED TO VFR USE ONLY” in clear view of the pilot. IFR VOR/LOC/GS operations are still permitted in this instance.

Contact Garmin AT for guidance on how to proceed in this case.

2.5.2 EXISTING SENSORS

When the GNS 480 is installed with external sensors, these sensors must be installed in accordance with the manufacturer's data. This manual does not provide information for the installation of specific external sensors.

The GNS 480 can accept data from multiple altitude, heading, and baro correction sources. If multiple sources are used, the GNS 480 will accept data as described below.

2.5.2.1 Multiple Altitude Sources

The GNS 480 can accept altitude from an RS232 altitude encoder, fuel/air data computer (FADC), ARINC 429 air data computer (ADC), an SL70/SL70R transponder, a GTX 33/330 transponder, and another GNS 480.

If multiple sources of altitude data are supplied to the GNS 480, only valid data from the highest priority source is used (input priority cannot be configured). If the highest priority source becomes unavailable, data is taken from the next-highest priority source. The priorities of the altitude sources are as follows (from highest to lowest):

1. ARINC 429 ADC
2. FADC
3. RS232 Altitude Encoder

NOTE

Although the GNS 480 can be configured to accept data from an RS232 altitude encoder on different ports, the GNS 480 cannot accept data from two RS232 altitude encoders.

4. SL70/SL70R Transponder or GTX 33/330 Transponder that receives Gray code altitude

NOTE

Altitude data received from a second GNS 480 will also be derived from one of the above sources. Data received on the GNS 480 cross-talk input is treated as if it is received directly from the source that is supplying altitude to the second GNS 480. If the direct input and the GNS 480 cross-talk input have the same priority, data from the direct input is used.

2.5.2.2 Multiple Heading Sources

The GNS 480 can accept heading from an ARINC 429 Heading Source, an FADC or an XYZ synchro source. If multiple sources of heading data are supplied to the GNS 480, only valid data from the highest priority source is used (input priority cannot be configured). If the highest priority source becomes unavailable, data is taken from the next-highest priority source. The priorities of the heading sources are as follows (from highest to lowest):

1. XYZ Synchro
2. ARINC 429 Heading Source
3. FADC

2.5.2.3 Multiple Baro Correction Sources

The GNS 480 can accept barometric correction from an altimeter with a baro correction potentiometer output, ARINC 429 ADC, FADC, MX20 display or another GNS 480.

If multiple sources of barometric correction data are supplied to the GNS 480, only valid data from the highest priority source is used. If the highest priority source becomes unavailable, data is taken from the next-highest priority source. The priorities of the barometric correction sources are as follows (from highest to lowest):

1. Baro correction potentiometer (from altimeter)
2. FADC (use of the baro correction and baro-corrected altitude can be disabled as part of the setup)
3. ADC (correction derived from ARINC 429 labels 203 and 204)
4. MX20 Display
5. Manual entry into GNS 480 (allowed only if no other baro correction sources are available)

NOTE

Baro correction data received from a second GNS 480 will also be derived from one of the above sources. Data received on the GNS 480 cross-talk input is treated as if it is received directly from the source that is supplying baro correction to the second GNS 480. If the direct input and the GNS 480 cross-talk input have the same priority, data from the direct input is used.

2.5.3 MOUNTING CONSIDERATIONS

The GNS 480 is designed to mount in the avionics stack in the aircraft instrument panel within view and reach of the pilot. The preferred location would minimize pilot head movement when transitioning between looking outside of the cockpit and viewing / operating the GNS 480. The location should be such that the GNS 480 is not blocked by the glare shield on top, or by the throttles, control yoke, etc. on the bottom.

For VFR-only installations, the GNS 480 must be mounted in the aircraft manufacturer approved location or other FAA approved location.

For IFR GPS installations, the GNS 480 must be mounted within the acceptable field-of-view, as defined in 2.5.3.1. If the GNS 480 cannot be mounted within the acceptable field-of-view this does not preclude IFR GPS operation, but additional FAA approval may be required.

To preclude the requirement for an external CDI/HSI source selection annunciation in IFR installations, the GNS 480 must be located in close proximity to the main (switched) CDI/HSI, as defined in 2.5.3.2. If the GNS 480 cannot be within the required distance of the CDI/HSI, then a CDI/HSI source selection annunciator must be provided (a CDI/HSI with a built-in annunciation may also be used in lieu of a separate external annunciator to satisfy the annunciation requirement).

For installations where two GNS 480's are installed, the second GNS 480 may be installed in the radio stack below the primary unit, or in a radio stack to the right of the primary radio stack (a second stack). In these instances, the primary GNS 480 must be installed within the acceptable field-of-view, and the preferred location for the secondary GNS 480 is also within the acceptable field of view. However, the secondary GNS 480 may be installed outside of the acceptable field-of-view but can only be used as a backup in the event of a failure of the primary GNS 480.

2.5.3.1 Determination of Acceptable Field-of-View

The FAA has determined that the acceptable field-of-view for TSO C146a installations is approximately $\pm 35^\circ$ horizontally from the center of the attitude indicator (or centerline of the pilot's seat / yoke). The acceptable vertical field-of-view includes the area from the top of the instrument panel to the portion of the instrument panel that is immediately below the basic 'T' instruments. For IFR GPS operations, the GNS 480 must be located within the acceptable field-of-view. Refer to Figure 2-1 and the steps below to determine whether or not the GNS 480 is within the acceptable field-of-view:

1. Measure the horizontal distance from the centerline to the left or right edge of the GNS 480, as appropriate.
2. If the GNS 480 is mounted to the right of the instruments, and the left edge of the GNS 480 is within 13.8 inches to the right of the centerline, and the bottom edge of the GNS 480 is in the acceptable area, the GNS 480 is considered within the acceptable field-of-view.
3. If the GNS 480 is mounted to the left of the instruments, and the right edge of the GNS 480 is within 11.8 inches to the left of the centerline, and the bottom edge of the GNS 480 is in the acceptable area, the GNS 480 is considered within the acceptable field-of-view.
4. If the GNS 480 does not meet the criteria for acceptable field-of-view as defined above, the installation may only be approved for IFR operations under the AML if the location has been previously approved by the FAA (ACO). Refer to Appendix E for a list of aircraft that do not meet the acceptable field-of-view requirement above but have been evaluated by the FAA and determined to be acceptable.

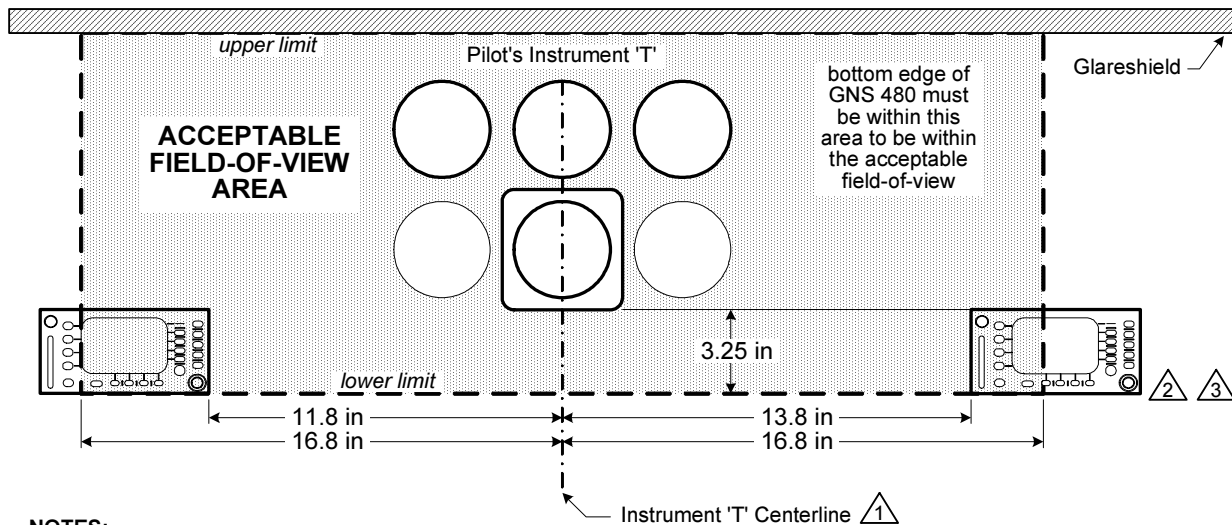

NOTES:

1. FOR AIRCRAFT WITHOUT THE BASIC INSTRUMENT 'T' CONFIGURATION, THE CENTER OF THE PILOT'S YOKE SHOULD BE USED TO DETERMINE THE CENTERLINE.
2. FOR AIRCRAFT WITHOUT THE BASIC INSTRUMENT 'T' CONFIGURATION, THE LOWER LIMIT OF THE ACCEPTABLE FIELD-OF-VIEW SHOULD BE 3.25 INCHES BELOW THE BOTTOM OF THE LOWEST INSTRUMENT TYPICALLY FOUND IN THE BASIC 'T' OR CDI, WHICHEVER IS LOWER.
3. FOR AIRCRAFT IN WHICH THE TYPE CERTIFICATED CDI OR HSI LOCATION IS BELOW THE BASIC 'T', THE LOWER LIMIT OF THE ACCEPTABLE FIELD-OF-VIEW SHOULD BE THE BOTTOM OF THE CDI OR HSI.

Figure 2-1 – Acceptable Field-of-View

2.5.3.2 CDI/HSI Source Selection Annunciator

The GNS 480 has the capability to switch between its internal VOR/ILS receiver and GPS receiver when driving a CDI/HSI. If the GNS 480 cannot be mounted such that the on-screen CDI/HSI source selection annunciation is entirely within the acceptable area shown in Figure 2-2, a CDI/HSI Source Selection Annunciator will be required to annunciate which source is presently driving the switched CDI/HSI. This annunciator **MUST** have illuminated NAV and GPS annunciations (i.e. the GPS and NAV text must be illuminated). The preferred location for this annunciator is on the same side of the switched CDI/HSI as the GNS 480. A CDI/HSI with a built-in NAV/GPS annunciation may also be used in lieu of a separate external annunciator to satisfy the annunciation requirement.

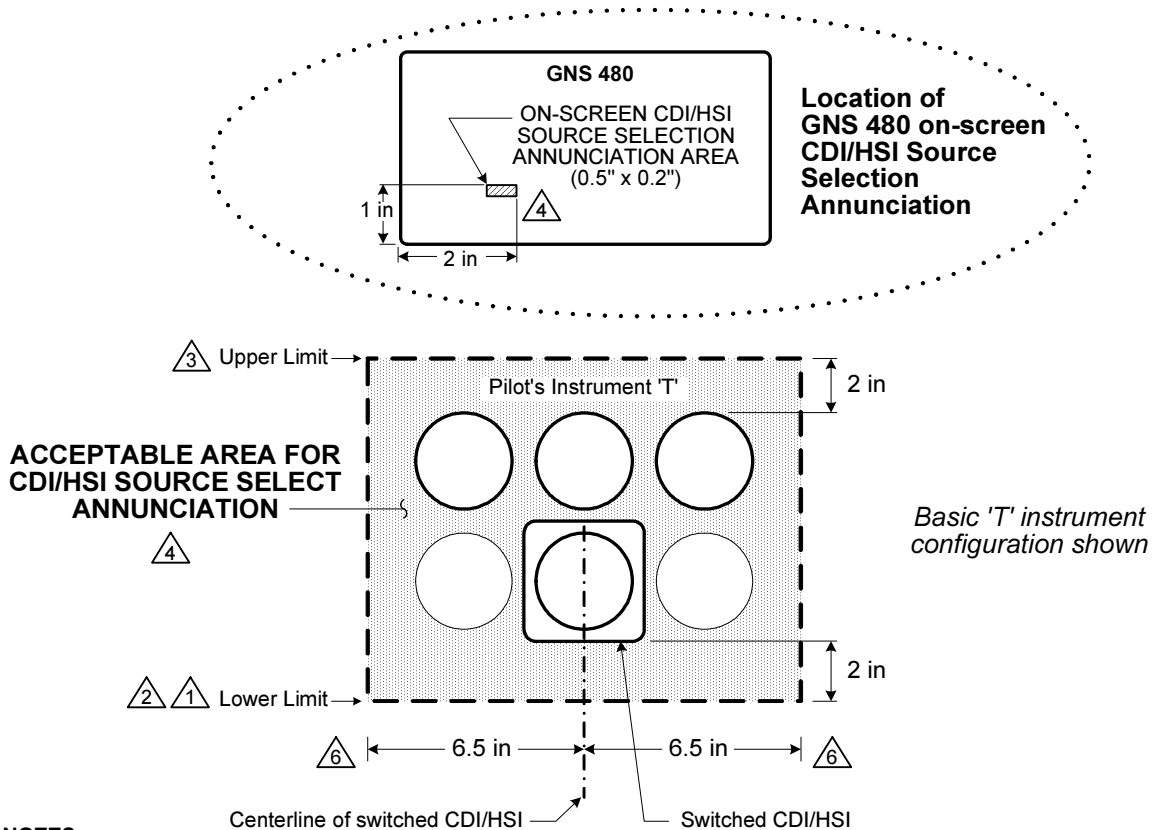

NOTES:

- ① FOR AIRCRAFT WITHOUT THE BASIC INSTRUMENT 'T' CONFIGURATION, THE LOWER LIMIT OF THE ACCEPTABLE FIELD-OF-VIEW SHOULD BE THE TWO INCHES BELOW THE BOTTOM OF THE LOWEST INSTRUMENT TYPICALLY FOUND IN THE BASIC 'T'.
- ② FOR AIRCRAFT IN WHICH THE TYPE CERTIFICATED CDI OR HSI LOCATION IS BELOW THE BASIC 'T', THE LOWER LIMIT OF THE ACCEPTABLE FIELD-OF-VIEW SHOULD BE IN LINE WITH THE BOTTOM OF THE CDI OR HSI.
- ③ FOR AIRCRAFT WITHOUT THE BASIC INSTRUMENT 'T' CONFIGURATION, THE UPPER LIMIT OF THE ACCEPTABLE FIELD-OF-VIEW SHOULD BE THE TWO INCHES ABOVE THE TOP OF THE HIGHEST INSTRUMENT TYPICALLY FOUND IN THE BASIC 'T'.
- ④ IF THE ENTIRE GNS 480 ON-SCREEN CDI SOURCE SELECTION ANNUNCIATION AREA IS WITHIN THE ACCEPTABLE AREA, AN EXTERNAL CDI/HSI SOURCE SELECTION ANNUNCIATOR IS NOT REQUIRED.
- ⑤ IF THE GNS 480 CANNOT BE INSTALLED TO PRECLUDE USE OF AN EXTERNAL CDI/HSI SOURCE SELECTION ANNUNCIATOR, A SOURCE SELECTION ANNUNCIATOR MUST BE INSTALLED WITHIN THE ACCEPTABLE AREA SHOWN ABOVE. THIS ANNUNCIATOR MUST BE **COMPLETELY** CONTAINED IN THE ACCEPTABLE AREA.
- ⑥ THE ACCEPTABLE ANNUNCIATION AREA IS WITHIN 6.5 INCHES HORIZONTALLY OF THE SWITCHED CDI/HSI. THIS MAY NOT NECESSARILY BE THE SAME AS THE CENTERLINE OF THE INSTRUMENT 'T' AS SHOWN ABOVE.

Figure 2-2 – Acceptable CDI/HSI Source Selection Annunciation Area

2.5.4 CABLING AND WIRING

Wiring should be installed in accordance with AC 43.13-1B Chapter 11. For dual GNS 480 installations, care should be taken to ensure separation between wires of redundant systems to reduce the possibility of loss of navigation due to a single event. When wire separation cannot be achieved, the following issues should be addressed:

- It should not be possible for a cable harness to be exposed to wire chafing in a manner that both GPS units fail simultaneously;
- The cable harness should not be located near flight control cables and controls, high electrical capacity lines or fuel lines;
- The cable harness should be located in a protected area of the aircraft (e.g., isolated from engine rotor burst); and
- Do not route cable near high-energy sources

Refer to the Electrical Connections in Appendix D for the appropriate wiring connections to assemble the wiring connector. Once the cable assemblies have been made, attach the cable connectors to the rear connector plate. After installing the mounting tube, attach the assembled connector. Route the wiring bundle as appropriate. Use 22 to 24 AWG wire for all connections except for power. Use 20 AWG for power/ground. Avoid sharp bends.

2.5.5 AIR CIRCULATION AND COOLING

The GNS 480 has internal fans for cooling. No external cooling is required. No special provisions are required during installation to accommodate the fans except to ensure the fan openings are not blocked.

2.5.6 COMPASS SAFE DISTANCE

After reconfiguring the avionics in the cockpit panel, if the GNS 480 is mounted less than seven inches from the compass, recalibrate the compass and make the necessary changes for noting correction data.

2.5.7 VIEWING ANGLE

The GNS 480 shall be located such that the operator will have easy access to the controls and have adequate view of the display. The GNS 480 may be adequately viewed from the primary pilot's position when the following minimums are met:

Up:	60 degrees off pilot's eye center line
Down:	35 degrees off pilot's eye center line
Right:	60 degrees off pilot's eye center line
Left:	60 degrees off pilot's eye center line

2.5.8 HELICOPTER INSTALLATION

The GNS 480 is qualified for helicopter installation – no special mounting tubes or other hardware is required.

Each helicopter installation must be individually field approved using the data in this manual, and other applicable documentation.

2.6 EQUIPMENT MOUNTING

The GNS 480 is designed to mount in the avionics stack. The installation kit supplied with the GNS 480 includes a mounting tube with a separate connector plate for ease of mounting, connections, and service of the unit. Allow an additional one-inch clearance to the rear of the mounting frame for connectors and cables. See Figure 2-3 for dimensions.

The GNS 480 does not require external cooling; however, when mounting the GNS 480, ensure that the fans at the rear of the unit are not blocked. As with all electronic equipment, avoid locating the GNS 480 near sources that produce high levels of heat.

2.6.1 MOUNTING TUBE INSTALLATION

Use the dimensions shown in Figure 2-3 to prepare the mounting holes for the GNS 480. You may also use the GNS 480 mounting tube itself as a template for drilling the mounting holes. Care must be taken when installing the mounting tube to ensure you can properly insert and secure the unit. There must be a minimum vertical spacing of 0.040 inches between units to prevent interference with the cam locking mechanisms. Mounting tubes with clearance dimples help maintain the proper clearance. The mounting tube must be installed with the clearance dimples pointing up.

2.6.1.1 Securing the Mounting Tube

Secure the mounting tube to the instrument panel structure using AN507 6-32 screws with a 100° countersink head. It is recommended that the installer use eight screws, four on each side. The mating holes in the instrument panel structure must also be countersunk to accept the screw head so that the screw head is flush with the inside surface of the mounting tube. Take care that the mounting tube is not distorted when it is attached to the instrument panel and structural supports. Shims may be necessary to properly install the mounting tube. If the mounting tube is distorted out of square, the unit may either bind when being inserted or the cam lock may not engage.

CAUTION

Failure to properly countersink the mounting holes will result in damage to the GNS 480. Mounting screw heads must not protrude into the mounting tube.

The front of the mounting tube should be flush to the instrument panel and allow sufficient clearance for the back of the bezel of the GNS 480 to mount flush to the mounting tube. Sufficient clearance must exist in the instrument panel opening to allow ease of insertion and removal of the GNS 480.

CAUTION

If the back of the GNS 480 bezel does not mount flush to the mounting tube (within 0.020"), the connector may not engage fully.

2.6.1.2 Mounting Frame Assembly

The order of assembly of the mounting tube frame with connector plate and connectors is at the installer's preference or may be determined by how the installation is fit into the aircraft. An illustration how to assemble the mounting tube is shown in.

All screws holding the connectors to the back plate and back plate to the mounting tube should be tightened to approximately to 7 – 9 in-lbs. After mounting the coax connectors to the connector plate, make sure that the coax connectors are floating or have slight movement.

NOTE

The washer must be installed with the smooth (rounded) surface facing the RF connector; otherwise, the RF connectors may bind when the screws are tightened. To further reduce the chances of binding, ensure that the mounting flange on each RF connector is straight prior to installation (when viewed from the long side of the connector). Straighten the flanges if they are observed to be bowed.

Refer to Section 2.7 Electrical Connections for details about how to wire the connectors.

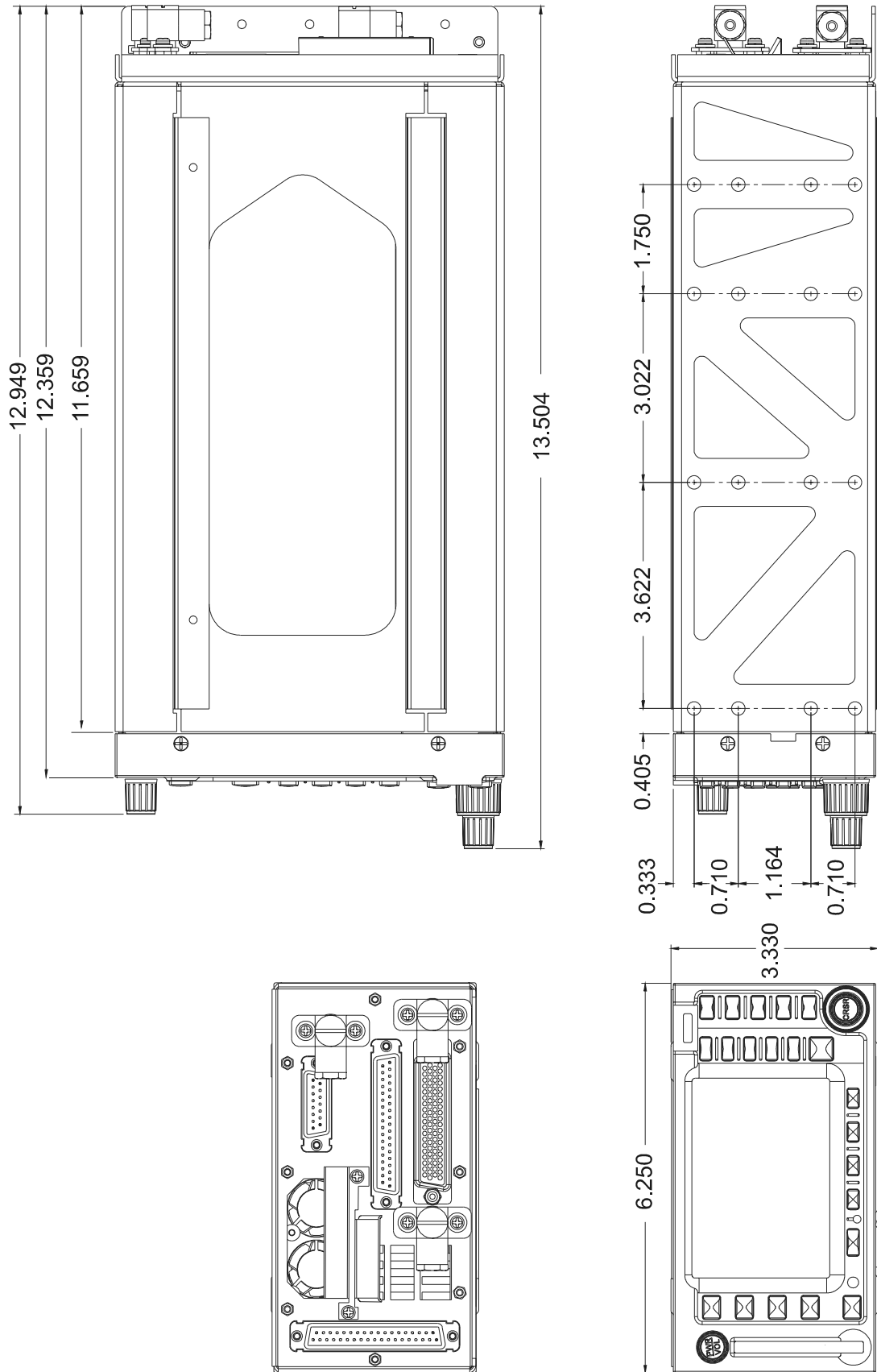

Figure 2-3 - GNS 480 Dimensions

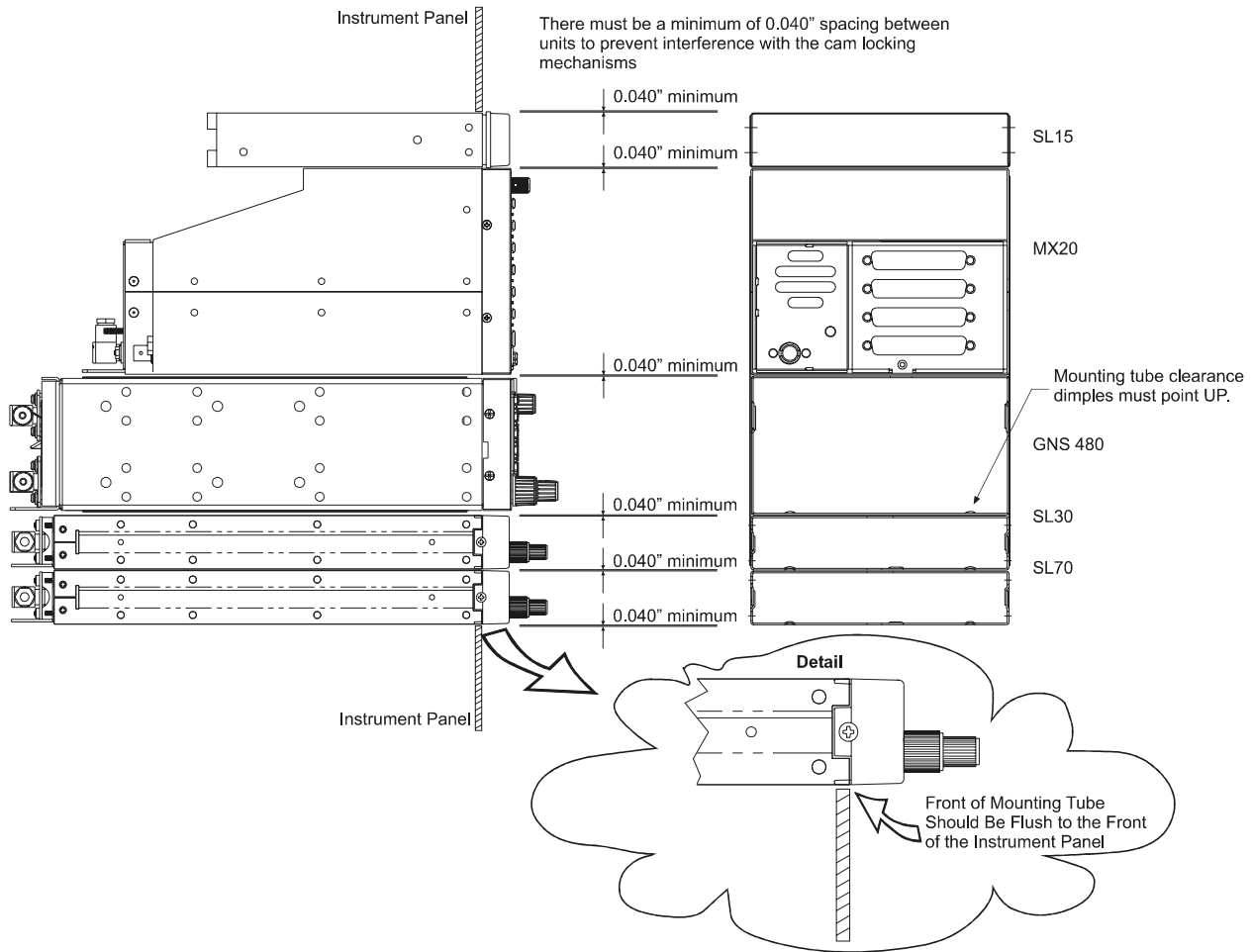

Figure 2-4 - Typical Mounting Rack

2.6.1.3 Mounting Tube Cable Routing

After the cable assemblies are made and wiring installed to the mounting tube back plate, route wiring bundle as appropriate.

Use tie wraps to secure the cable assemblies and coax to the holes provided in the bottom of the connector plate to provide strain relief for the cable assemblies. The cable shields should be grounded directly to a lug mounted to one of the holes on the bottom of the connector plate, keeping the ground leads to a maximum of 3 inches long.

2.6.2 UNIT INSERTION

Position the cam lock as shown below. The front lobe of the cam should be vertical. The cam lock mechanism should be fully unscrewed (turned counter-clockwise). Slide the unit into the frame. Turn clockwise and carefully tighten (15 in-lb max.) the cam lock mechanism using a 3/32" hex driver. The unit will be pulled into the frame, securing the unit and connectors when fully engaged. **Do NOT overtighten.** The back of the bezel must be flush to the mounting tube (within 0.020"). If the cam lock is hard to turn or the unit does not seat fully, the unit is probably binding and the mounting tube should be checked.

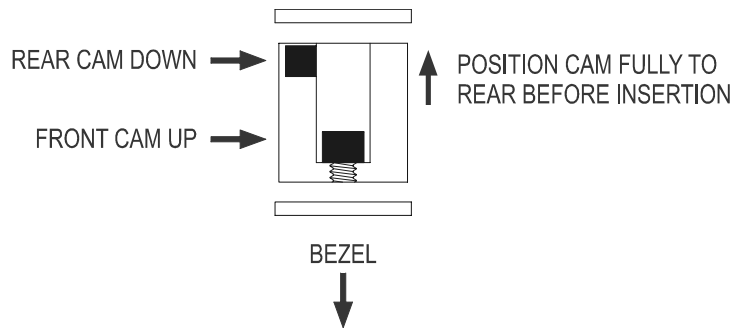

Figure 2-5 - Cam Lock Positioning

2.6.3 UNIT REMOVAL

To remove the unit from the mounting frame, turn the screw counter-clockwise with the hex driver to unscrew the cam lock mechanism. The unit will begin to pull away from the mounting tube. Turn the screw until slight resistance is felt and then pull the unit from the frame. **Do not exert excessive turning force at the end of the cam lock travel or the unit may be damaged.** With the cam lock fully disengaged, pull the unit straight out while holding onto the sides of the bezel. It is not recommended that you pull the unit out by the rotary knobs. No special extraction tools are required if the mounting tube is properly installed.

2.6.4 UNIT REPLACEMENT

Whenever the GNS 480 is removed and reinstalled, verify that the GNS 480 unit power-up self-test sequence is successfully completed and no failure messages are annunciated. If the unit was serviced or if a different unit is being installed, accomplish the setup and configuration procedures defined in 3.2 prior to verifying that the GNS 480 unit power-up self-test sequence is successfully completed and no failure messages are annunciated. The setup items for a particular installation should have been previously recorded on a Post-Installation Checkout Log that was completed upon initial installation (refer to Table 3-7).

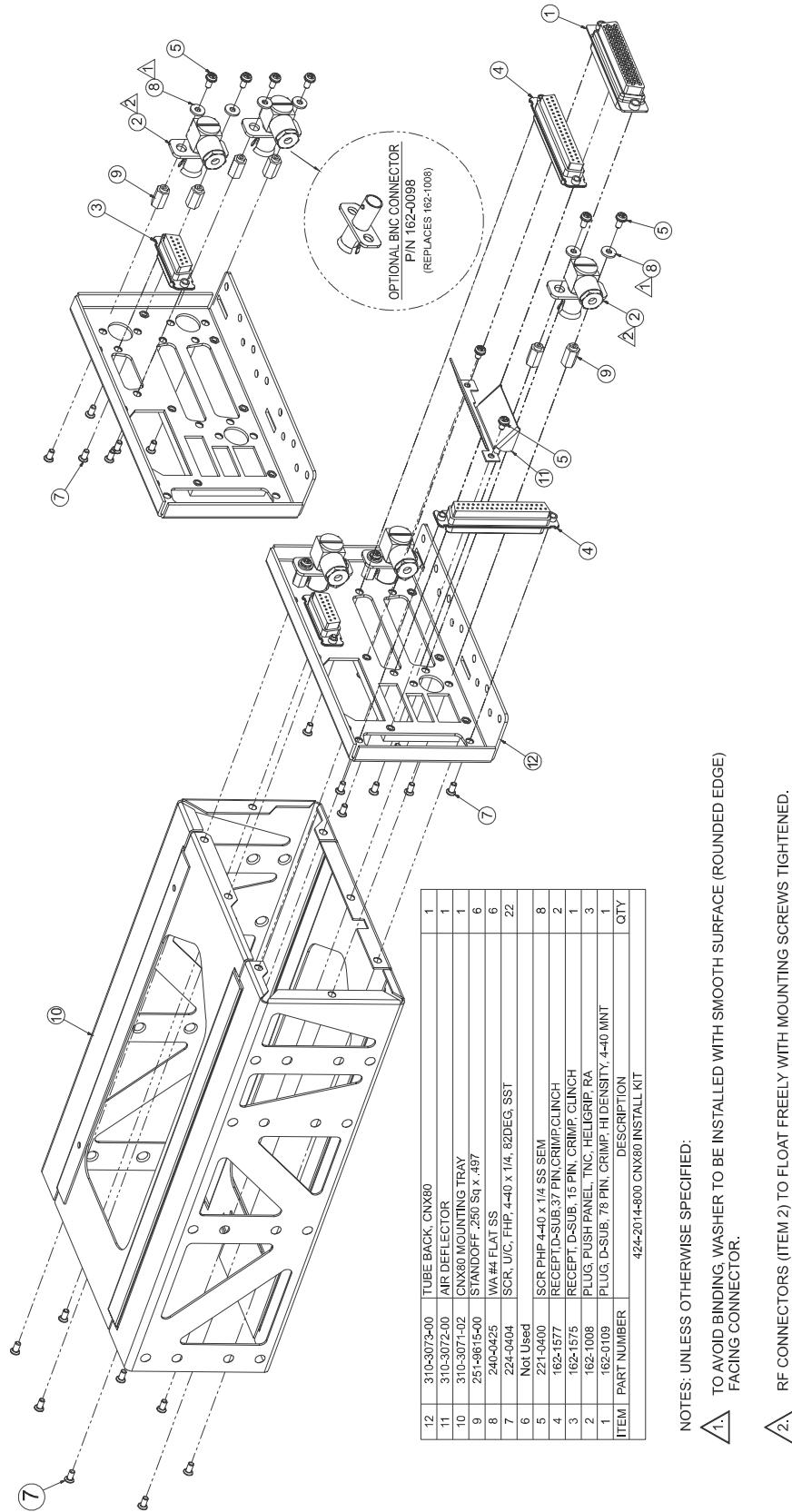

Figure 2-6 - Mounting Frame Assembly

2.7 ELECTRICAL CONNECTIONS

The GNS 480 installation kit includes four D-sub connectors and three coax connectors. The connector layouts are shown in Figure 2-7. The D-sub connectors use the supplied crimp contacts as specified in Table 2-3. Make the crimp connections with the crimp tool specified Section 2.4.

Table 2-3 - Interface Connectors

Figure 2-7		Connector		Crimp Contact	
Ref.	Description	P/N	Description	P/N	Description
P1	Main System	162-1577	37 Pin D-Sub Receptacle	245-0027	20-24 AWG socket contact
P2	GPS antenna	162-1008	Coax Plug, right angle mnt	N/A	N/A
P3	Com antenna	162-1008	Coax Plug, right angle mnt	N/A	N/A
P4	Com I/O	162-1575	15 Pin D-Sub Receptacle	245-0027	20-24 AWG socket contact
P5	I/O Expansion	162-0109	78 Pin D-Sub Plug	162-0082	22-28 AWG pin contact
P6	NAV antenna	162-1008	Coax Plug, right angle mnt	N/A	N/A
P7	NAV I/O	162-1577	37 Pin D-Sub Receptacle	245-0027	20-24 AWG socket contact

The following table shows the specifications for the crimp contacts. Alternate crimp contact part numbers may be used that are equivalent to those specified in the table below. See Section 2.4 for the appropriate crimp tool examples.

Table 2-4 - Crimp Contact Specifications

Garmin AT Part Number	162-0082	245-0027
Description	22-28 AWG crimp pin contact	20-24 AWG crimp socket contact
Color bands	Orange/Blue/Black	Orange/Blue/Gray
ITT/Cannon P/N	030-2042-000	031-1007-042
Military number	M39029/58-360	M39029/63-368

2.7.1 INTERFACE CONNECTOR DEFINITION

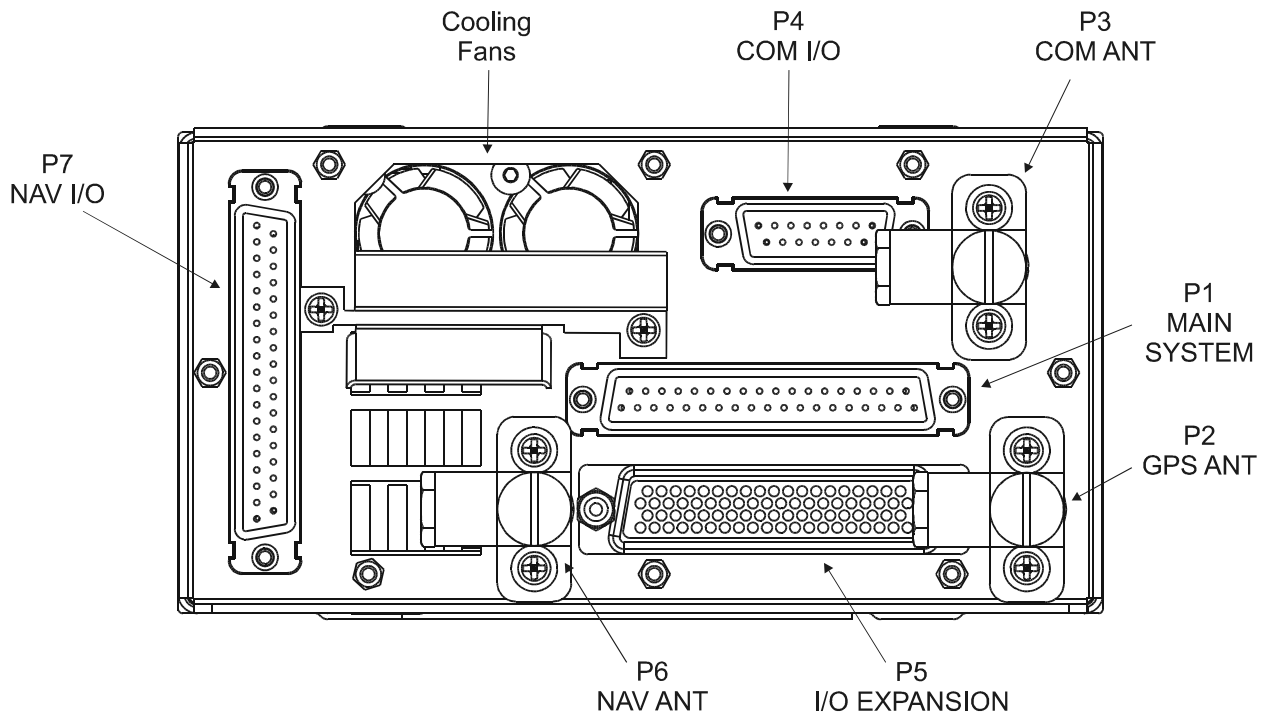

Figure 2-7 - Rear Mounting Tube Connector Layout

NOTE

The rear connector plate is shown with right-angle RF connectors. Straight RF connectors with female BNC connections (Garmin AT P/N 162-0098) are available as an option, allowing a regular male BNC connector to be used on the antenna cables.

2.7.1.1 Main System Connector (P1)

The interface to external equipment is made through a standard male 37-pin D-sub connector near the middle of the unit. The pin-out for the connector is defined in the following table.

Table 2-5 Main System Connector Pin-Out (P1)				
Pin #	I/O	Name	Description	Reference
1	I	Power +	Main Aircraft Power Input (+10 to +36 VDC)	2.8.1
2	I	Power Ground	Main Aircraft Power Ground	
3	O	Serial Ground 2	RS232 signal ground	2.8.10.1
4	I	RS232 RxD1	RS232 channel 1 serial data input	
5	O	RS232 TxD1	RS232 channel 1 serial data output	
6	O	RS232 TxD3	RS232 channel 3 serial data output	
7	I	RS232 RxD3	RS232 channel 3 serial data input	
8	O	RS422 TxD4 +	RS422 channel 4 serial data output +	
9	--	RESERVED	RESERVED	
10	O	RS422 TxD4 -	RS422 channel 4 serial data output -	2.8.10.1
11	I	RS422 RxD4 +	RS422 channel 4 serial data input +	
12	--	RESERVED	RESERVED	
13	--	RESERVED	RESERVED	
14	I	Com Flip Flop In	COM Flip-Flop discrete input (active low)	2.8.9.2
15	I	UP Discrete In	Activate COM User list and scrolls up (active low)	2.8.9.5
16	I	Power +	Main Aircraft Power Input (+10 to +36 VDC)	2.8.1
17	O	Time Mark Out +	GPS 1 Pulse Per Second Output + (RS422 Level)	2.8.11
18	--	RESERVED	RESERVED	
19	O	Time Mark Out -	GPS 1 Pulse Per Second Output - (RS422 Level)	2.8.11
20	I	Power Ground	Main Aircraft Power Ground	2.8.1
21	I	RS232 RxD2	RS232 channel 2 serial data input	2.8.10.1
22	O	RS232 TxD2	RS232 channel 2 serial data output	
23	O	Serial Ground 1	RS232 signal ground	
24	--	RESERVED	RESERVED	
25	O	Serial Ground 3	RS232 signal ground	2.8.10.1
26	I	RS422 RxD4 -	RS422 channel 4 serial data input -	
27	--	RESERVED	RESERVED	
28	--	RESERVED	RESERVED	
29	--	RESERVED	RESERVED	
30	--	RESERVED	RESERVED	
31	--	RESERVED	RESERVED	
32	--	RESERVED	RESERVED	
33	I	DOWN Discrete In	Activate COM User list and scrolls down (active low)	2.8.9.5
34	I	VOR Flip Flop In	VOR Flip-Flop discrete input (active low)	2.8.9.3
35	I	Power + Out (Nav)	Main Power Output for Nav Receiver	2.8.1
36	--	RESERVED	RESERVED	
37	I	Power Gnd Out (Nav)	Main Power Ground Output for Nav Receiver	2.8.1

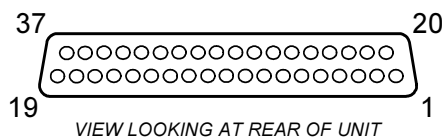
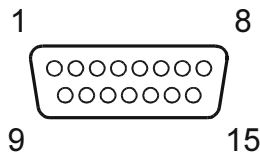

Figure 2-8 - 37-pin Connector

2.7.1.2 Com I/O Connector (P4)

The GNS 480 communication interface is handled via a standard density male 15-pin D-sub connector located at the top of the unit. Internally this connection is on the VHF COM board. The pinout for the connector is defined in the following table.

Table 2-6 COM I/O Connector Pin-Out (P4)				
Pin #	I/O	Name	Description	Reference
1	I	Aircraft Power	Main Aircraft Power Input (+10 to +36 VDC)	2.8.1
2	--	RESERVED	RESERVED	
3	--	RESERVED	RESERVED	
4	I	PTT	Push To Talk, Transmit Key (active low)	2.8.9.4
5	--	RESERVED	RESERVED	
6	O	Com Speaker Out	Speaker output (high-level audio)	2.8.12.1
7	I	Com MIC In Low	Microphone input - analog ground	2.8.12.2
8	I	Com MIC In High	Microphone input - High	
9	I	Power Ground	Main Aircraft Power Ground	2.8.1
10	--	RESERVED	RESERVED	
11	--	RESERVED	RESERVED	
12	--	RESERVED	RESERVED	
13	O	Com Audio Ground	Speaker or Headphone output ground	2.8.12.1
14	O	Com Headphone Out	Headphone output (low-level audio)	
15	--	RESERVED	RESERVED	



View looking at rear of unit

Figure 2-9 - 15-Pin Connector

2.7.1.3 I/O Expansion Connector (P5)

Additional I/O for the GNS 480 is achieved via the I/O expansion connector, which consists of a high density female 78-pin D-sub connector near the bottom of the unit. The pinout for the connector is defined in the following table.

Pin #	I/O	Name	Description	Reference
1	I	RS232 RxD5	RS232 channel 5 serial data input	2.8.10.1
2	I	RS232 RxD6	RS232 channel 6 serial data input (opto-isolated)	
3	--	RESERVED	RESERVED	
4	O	429 OUT 1A	ARINC 429 Output Channel 1A	2.8.10.2
5	O	429 OUT 2A	ARINC 429 Output Channel 2A	
6	--	RESERVED	RESERVED	
7	I	429 IN 1A	ARINC 429 Input Channel 1A	2.8.10.2
8	I	429 IN 2A	ARINC 429 Input Channel 2A	
9	I	429 IN 3A	ARINC 429 Input Channel 3A	
10	I	RS232 RxD7	RS232 channel 7 serial data input (receive-only channel)	2.8.10.1
11	--	RESERVED	RESERVED	
12	--	RESERVED	RESERVED	
13	I	Baro In (W)	Baro Correction Input (wiper)	2.8.5
14	I/O	DME Clock Bus	Digital Serial DME Clock Bus	2.8.16
15	I/O	DME Data Bus	Digital Serial DME Data Bus	
16	O	OBI Clock	Digital OBI Clock	2.8.15.1
17	O	OBI Data	Digital OBI Data	
18	I	Hdg Synchro Y	Heading Synchro Input (Y)	2.8.6
19	I	Hdg Synchro X	Heading Synchro Input (X)	
20	I	Hdg Synchro Ref Hi	Heading Synchro Reference In (Hi)	
21	O	RS232 TxD5	RS232 channel 5 serial data output	2.8.10.1
22	O	RS232 TxD6	RS232 channel 6 serial data output (opto-isolated)	
23	--	RESERVED	RESERVED	
24	O	429 OUT 1B	ARINC 429 Output Channel 1B	2.8.10.2
25	O	429 OUT 2B	ARINC 429 Output Channel 2B	
26	--	RESERVED	RESERVED	
27	I	429 IN 1B	ARINC 429 Input Channel 1B	2.8.10.2
28	I	429 IN 2B	ARINC 429 Input Channel 2B	
29	I	429 IN 3B	ARINC 429 Input Channel 3B	
30	I	RS232 RxD8	RS232 channel 8 serial data input (receive-only channel)	2.8.10.1
31	--	RESERVED	RESERVED	
32	--	RESERVED	RESERVED	
33	O	Baro Hi	Baro Correction Excitation Output	2.8.5
34	I	DME Select In	Digital Serial DME Select (active low)	2.8.16
35	I	DME Channel Req	Digital Serial DME Channel Request (RNAV)	
36	I	OBI Select In	RMI Selection input (Open = GPS, GND = NAV)	2.8.15.2
37	O	OBI Sync	Digital OBI Sync Pulse	2.8.15.1
38	I	Hdg Synchro Z	Heading Synchro Input (Z)	2.8.6
39	I	Hdg Synchro Ref Lo	Heading Synchro Reference In (Lo)	
40	O	Message Audio Out	Low Level Message Audio Out (to audio panel)	2.8.14.1
41	O	Serial Ground 5	RS232 signal ground	2.8.10.1
42	O	Serial Ground 6	RS232 signal ground	
43	O	Message Audio Gnd	Message Audio ground signal (or spare ground)	2.8.14.1

Table 2-7 I/O Expansion Connector Pin-Out (P5)

Pin #	I/O	Name	Description	Reference
44	O	Serial Ground 7/8	RS232 signal ground (or spare ground)	2.8.10.1
45	O	Aux CDI +Left	GPS CDI Left	2.8.3
46	O	Aux CDI +Right	GPS CDI Right	
47	O	Aux CDI +TO	GPS TO Flag	
48	O	Aux CDI +FROM	GPS FROM Flag	
49	O	Aux CDI +Valid	GPS CDI Valid Flag	
50	O	Aux VDI +Up	GPS VDI Up	
51	O	Aux VDI +Down	GPS VDI Down	
52	O	Aux VDI +Valid	GPS VDI Valid Flag	
53	O	Baro Lo	Baro Correction Return (Ground)	2.8.5
54	O	Aux CDI -Valid	GPS CDI Valid Return	2.8.3
55	O	Aux VDI -Valid	GPS VDI Valid Return	
56	--	RESERVED	RESERVED	
57	I	Heading Valid In	Syncro Heading Valid Input	2.8.6
58	--	RESERVED	RESERVED	
59	--	RESERVED	RESERVED	
60	O	Dead Reck Annunciate	Dead Reckoning Annunciator (active low)	2.8.7.3
61	O	Approach Annunciate	Approach Active Annunciator (active low)	2.8.7.4
62	O	Parallel Track Annc	Parallel Track Annunciator (active low)	2.8.7.5
63	O	Suspend Annunciate	Suspend Annunciator (active low)	2.8.7.6
64	O	Message Annunciate	Message Annunciator (active low)	2.8.7.7
65	O	LOI Annunciate	Loss of Integrity Annunciator (active low)	2.8.7.8
66	O	Waypoint Annunciate	Waypoint Annunciator (active low)	2.8.7.9
67	O	Term Mode Annc	Terminal Mode Annunciator (active low)	2.8.7.10
68	O	Precision Appr	Precision Approach Output (active low)	2.8.8.2
69	O	Altitude Alert Annc	Low Altitude Alert Annunciator (active low)	2.8.7.11
70	O	Audio Msg Active Out	Audio Message Active Annunciator (active low)	2.8.8.3
71	--	RESERVED	RESERVED	
72	I/O	Discrete In/Out 1	Discrete In/Out 1 (active low)	2.8.8.5
73	I/O	Discrete In/Out 2	Discrete In/Out 2 (active low)	
74	I/O	Discrete In/Out 3	Discrete In/Out 3 (Not implemented at time of publication)	
75	I/O	Discrete In/Out 4	Discrete In/Out 4 (Not implemented at time of publication)	
76	I	Suspend In	Suspend, places auto sequencing on hold (active low)	2.8.9.6
77	I	Audio Inhibit In	Inhibit Audio Messages (active low)	2.8.9.7
78	--	RESERVED	RESERVED	

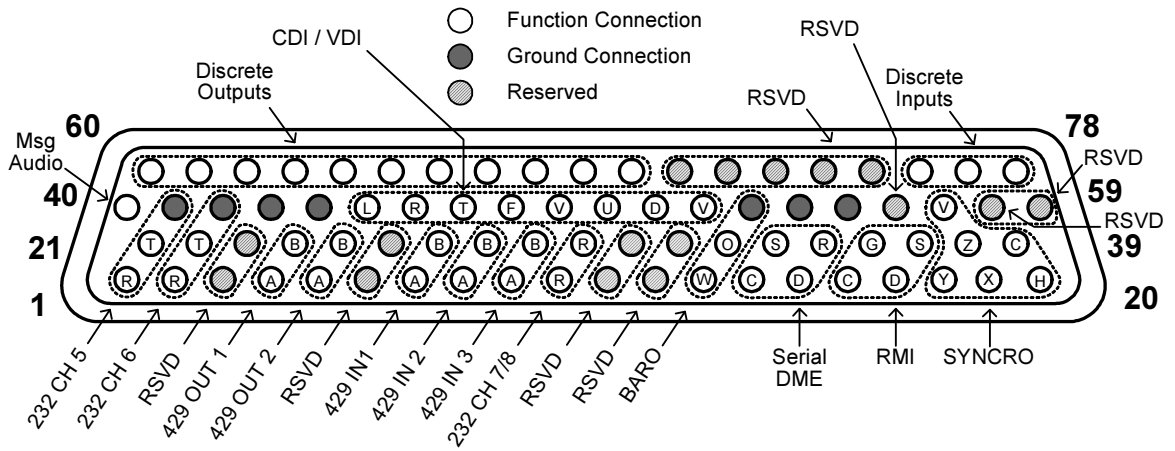

VIEW LOOKING AT REAR OF UNIT

Figure 2-10 - 78-Pin Connector Detail

2.7.1.4 Nav I/O Connector (P7)

A navigation I/O connector, which handles VHF NAV / GPS switching, resolver and main CDI/VDI interfaces, is located vertically on the left side of the rear panel. The NAV I/O hooks internally to the VHF NAV board and consists a standard 37-pin D-sub connector, and has a pinout similar to the SL30 VHF NAV unit for simpler field upgrading. The pinout for the connector is defined in the following table.

Table 2-8 NAV I/O Connector Pin-Out (P7)				
Pin #	I/O	Name	Description	Reference
1	I	Power +	Main Aircraft Power Input (+10 to +36 VDC)	2.8.1
2	I	Power ground	Main Aircraft Power Ground	
3	O	Spare ground	No current assignment	
4	--	RESERVED	RESERVED	
5	--	RESERVED DB30 TxD	RESERVED (for use with the DB30)	2.8.10.1
6	--	RESERVED	RESERVED	
7	I	OBS_D {S1}	OBS Resolver input pin from channel D (COS)	2.8.2
8	I	Main CDI Select In	Selects between GPS & VHF NAV on Main CDI Output	2.8.9.1
9	O	Main GS Superflag	Glideslope Indicator Valid flag output (high-level)	2.8.2
10	O	Main CDI + Valid	Nav Valid flag output (low-level)	
11	O	Main CDI + FROM	+ From flag output	
12	O	Main CDI + TO	+ To flag output	
13	O	Main CDI + Right	CDI + Right output	
14	O	Main CDI + Left	CDI + Left output	
15	O	Back Course Out	active low output when reverse sensing is engaged	2.8.7.2
16	O	OBS_F {S4}	OBS OBS Resolver input pin from channel F (SIN)	2.8.2
17	O	GPS Indicator Out	active low output when GPS selected on Main CDI output	2.8.7.1
18	O	NAV Indicator Out	active low output when VHF NAV selected on Main CDI out	
19	O	Composite Out	VOR/LOC composite signal	2.8.4
20	O	NAV Audio Ground	audio signal ground pin	2.8.13.1
21	--	RESERVED	RESERVED	
22	--	RESERVED	RESERVED	
23	O	NAV Audio Out	low-level nav audio output	2.8.13.1
24	O	OBS_H {R HI}	OBS Resolver output pin to channel H	2.8.2
25	O	OBS_C {R LO}	OBS Resolver return signals C	
26	I	OBS_E {S3}	OBS Resolver return signals E	
27	O	Main CDI Superflag	CDI high-level Valid flag output	
28	O	Main GS + Valid	Nav Valid flag output (low-level)	
29	O	Main CDI - Valid	Nav Valid flag signal ground	
30	O	Main GS + Up	Glideslope + Up output	
31	O	Main GS + Down	Glideslope + Down output	
32	O	Main GS - Valid	Glideslope Valid flag signal ground	
33	O	ILS Energize	active low output when a localizer frequency is tuned	2.8.8.1
34	O	OBS_G {S2}	OBS Resolver return signals G	2.8.2
35	--	RESERVED	RESERVED	
36	O	Power Control Out	power control output sinks up to 50ma when unit is on	2.8.8.4
37	O	Composite Ground	return path for the composite signal	2.8.4

(see Figure 2-8 for a diagram of a 37-pin connector)

2.8 FUNCTIONAL DESCRIPTIONS

2.8.1 POWER

Aircraft power is provided to the GNS 480 on several connectors. The GNS 480 will accept input power from 10 to 36 VDC.

P1-1	Power + (Primary)
P1-16	Power + (Primary)
P1-35	Power + Out (Nav)
P4-1	Power + (Com transceiver)
P7-1	Power + (Nav receiver)
P1-2	Power Ground (Primary)
P1-20	Power Ground (Primary)
P1-37	Power Gnd Out (Nav)
P4-9	Power Ground (Com transceiver)
P7-2	Power Ground (Nav receiver)

CAUTION

Two sets of primary power and ground pins are provided on P1. Both sets MUST be connected to the aircraft power source or damage to the unit may occur.

Refer to Appendix D for recommended power connections.

2.8.2 MAIN COURSE DEVIATION INDICATOR

The Main CDI output displays both lateral and vertical deviation from selected course, lateral and vertical flags and superflags, and TO/FROM indications.

The CDI key on the bezel of the GNS 480 is used to toggle between the display of GPS and VOR/ILS information on the CDI window and remote CDI. The navigation source is displayed in the CDI window. The navigation source can optionally be annunciated externally by connecting the GPS Indicator output (P7-17) and NAV Indicator output (P7-18). The selection of GPS or VOR/ILS navigation sources may be toggled remotely by momentarily grounding the CDI Select input (P7-8) is (refer to section 2.8.4 for additional information on the external annunciators and switches).

NOTE

If the GNS 480 is setup to IGNORE the CDI select key and discrete input (refer to 3.2.1.6), the Main CDI output will always be based on VOR/ILS information, even though GPS information will be displayed in the CDI window and 'GPS' will be annunciated beside the CDI key.

Refer to Appendix D for interconnect information.

2.8.2.1 Deviation Outputs

- P7-13 Main CDI + Right
- P7-14 Main CDI + Left
- P7-30 Main GS + Up
- P7-31 Main GS + Down

Each deviation output provides ± 150 mV full scale and is capable of driving up to a 200Ω load, (i.e. up to a maximum of five $1k\Omega$ loads connected in parallel).

2.8.2.2 TO / FROM Output

- P7-11 Main CDI + FROM
- P7-12 Main CDI + TO

The TO / FROM output provides ± 250 mV and is capable of driving up to a 200Ω load, (i.e. up to a maximum of five $1k\Omega$ loads connected in parallel).

2.8.2.3 Flags

- P7-10 Main CDI + Valid
- P7-29 Main CDI - Valid
- P7-28 Main GS + Valid
- P7-32 Main GS - Valid

Each flag output provides +300 mV when valid information is present and is capable of driving up to a 200Ω load, (i.e. up to a maximum of five $1k\Omega$ loads connected in parallel).

2.8.2.4 Superflags

- P7-9 Main GS Superflag
- P7-27 Main CDI Superflag

Each flag output provides $(V_{in} - 2)$ volts relative to ground when valid information is present, where V_{in} represents the aircraft power supplied to the GNS 480. Each output is capable of supplying up to 400 mA.

2.8.2.5 OBS Resolver

The OBS resolver input should be compatible with a standard 6-wire OBS interface - any electrical zero crossing will work because the GNS 480 will calibrate out any errors.

- P7-7 OBS_D {S1} (COS input high)
- P7-16 OBS_F {S4} (SIN input high)
- P7-24 OBS_H {R HI} (Reference output high)
- P7-25 OBS_C {R LO} (Reference output low)
- P7-26 OBS_E {S3} (COS input low)
- P7-34 OBS_G {S2} (SIN input low)

NOTE

The GNS 480 cannot drive multiple resolvers at the same time. It is not recommended that external resolvers be switched through a relay or other means because the resolver must be calibrated to the radio. If multiple resolvers are desired in the installation, the primary unit must be installed and calibrated as described herein. The secondary unit should use the composite output.

Refer to section 3.2.1.3 for information on calibrating the resolver input.

2.8.3 AUXILIARY COURSE DEVIATION INDICATOR

The Auxiliary CDI output displays both lateral and vertical deviation from selected course, lateral and vertical flags, and TO/FROM indications. This output is always based upon GPS information, regardless of the navigation source that is selected for the Main CDI output using the CDI bezel key. Since the Main CDI output can normally be switched between GPS and VOR/ILS, it is not necessary to use these outputs to drive an indicator. It is only necessary if it is desired to have a separate indicator display GPS deviation information full-time. This output does not provide superflag outputs, so if superflags are required a converter box must be used to generate the required signals using the low-level valid flags.

Refer to Appendix D for interconnect information.

2.8.3.1 Deviation Outputs

P5-45	Aux CDI + Left
P5-46	Aux CDI + Right
P5-50	Aux GS + Up
P5-51	Aux GS + Down

Each deviation output provides ± 150 mV full scale and is capable of driving up to a 200 Ω load, (i.e. up to a maximum of five 1k Ω loads connected in parallel).

2.8.3.2 TO / FROM Output

P5-47	Aux CDI + TO
P5-48	Aux CDI + FROM

The TO / FROM output provides ± 250 mV and is capable of driving up to a 200 Ω load, (i.e. up to a maximum of five 1k Ω loads connected in parallel).

2.8.3.3 Flags

P5-49	Aux CDI + Valid
P5-54	Aux CDI - Valid
P5-52	Aux VDI + Valid
P5-55	Aux VDI - Valid

Each flag output provides +300 mV when valid information is present and is capable of driving up to a 200 Ω load (i.e. up to a maximum of five 1k Ω loads connected in parallel).

2.8.4 COMPOSITE INDICATOR

The GNS 480 provides a standard VOR/localizer composite output signal that may be used to drive the left/right deviation, TO / FROM and valid flag indications of certain navigation indicators that contain an internal converter. If an external converter is driven from the composite output, the composite output will be disabled whenever the VOR monitor mode is active or back course localizer mode is enabled. This will cause the external converter to flag.

- P7-19 Composite Out
- P7-37 Composite Ground

In the VOR mode, the composite signal output is $0.500 V_{RMS}$. In the localizer mode, the composite signal output is $0.390 V_{RMS}$. This output is capable of driving up to a 1000Ω load.

Refer to Appendix D for interconnect information.

2.8.5 ALTIMETER

The GNS 480 accepts altitude data serially, using either RS232 or ARINC 429 inputs. Refer to section 2.8.10 for additional information on the serial interfaces. In addition, the GNS 480 can accept the baro-correction using the potentiometer output from a suitable altimeter. If baro-correction and uncorrected pressure altitude are provided to the GNS 480, baro-corrected altitude will be output by the GNS 480.

- P5-13 Baro In (W)
- P5-33 Baro Hi
- P5-53 Baro Lo

CAUTION

The GNS 480 must not be connected in parallel with other equipment using the baro pot. Damage to the GNS 480 or other the equipment may occur if this is done.

Refer to Appendix D for altimeter baro potentiometer connections to several altimeters. Refer to section 3.2.1.4 for information on calibrating the baro potentiometer input.

2.8.6 SYNCHRO HEADING

The GNS 480 accepts heading information using either a synchro input or serially, using either RS232 or ARINC 429 inputs. Refer to section 2.8.10 for additional information on the serial interfaces. If synchro heading is provided, refer to the paragraphs below. Refer to Appendix D for interconnect information.

2.8.6.1 Heading Synchro

- P5-19 Hdg Synchro X
- P5-18 Hdg Synchro Y
- P5-38 Hdg Synchro Z

Connect these pins to an XYZ type directional gyro.

2.8.6.2 Heading Synchro Reference Voltage

P5-20 Hdg Synchro Ref Hi
P5-39 Hdg Synchro Ref Lo

A reference voltage must be provided if the synchro heading input is used. This input should be 26 VAC 400 Hz (nominal) and provided by the same source that provides the excitation voltage to the synchro heading source.

2.8.6.3 Heading Synchro Valid Input

P5-57 Heading Valid In

This input is an active high discrete input that provides synchro heading validity information to the GNS 480. If the voltage on this input is > 9 VDC the synchro heading is considered valid, and if the voltage is < 9 VDC (or the input is open-circuit) the synchro heading is considered invalid.

2.8.7 ANNUNCIATOR OUTPUTS

NOTE

Installations in conformance with the requirements specified in this installation manual may not require the use of any external annunciators, since all annunciations are provided on the GNS 480 front panel. Refer to 2.5.3 to determine whether or not external annunciators are required.

All of the annunciator outputs duplicate annunciations available on the front of the GNS 480. These can be used to drive annunciator lamps to make the annunciation available remotely (such as in the pilot's primary field of view). All of these outputs are active low (i.e. grounded when active, and open otherwise). Each is an open collector output capable of sinking up to 400 mA. These outputs are normally open and are only grounded under the conditions described herein.

2.8.7.1 GPS / Nav Annunciations

P7-17 GPS Indicator Out
P7-18 NAV Indicator Out

The GPS Indicator Out (P7-17) will be grounded when GPS is being used as the navigation source to drive the Main CDI, and open otherwise. The NAV Indicator Out (P7-18) will be grounded when VOR/ILS is being used as the navigation source to drive the Main CDI, and open otherwise.

If external annunciators are used for the GPS/Nav annunciation, it is recommended that the GPS annunciator is labeled "GPS" in white text, and the Nav annunciator is labeled "NAV" in green text. Alternately, the annunciator may be labeled with "GPS" in black text on a white background, and "NAV" in black text on a green background. Refer to 2.5.3.2 for additional information on source selection annunciators

2.8.7.2 Back Course Annunciation

P7-15 Back Course Out

The Back Course Out will be grounded when the back course localizer mode is enabled.

If an external annunciator is used for back course annunciation, it is recommended that the back course annunciator be labeled “BC” in amber text.

2.8.7.3 Dead Reckoning Annunciation

P5-60 Dead Reck Annnc

The Dead Reck Annnc output is grounded whenever the GNS 480 is in dead reckoning mode (i.e. whenever the GPS position is lost and the last-known groundspeed is > 3kts).

If an external annunciator is used for dead reckoning annunciation, it is recommended that the dead reckoning annunciator be labeled “DR” in amber text.

2.8.7.4 Approach Annunciation

P5-61 Approach Annunciate

The Approach Annunciate output is grounded when performing approach navigation and approach is active.

If an external annunciator is used for approach annunciation, it is recommended that the approach annunciator be labeled “APPR” in green text.

2.8.7.5 Parallel Track Annunciation

P5-62 Parallel Track Annnc

The Parallel Track Annnc output is grounded whenever the parallel track mode has been selected.

If an external annunciator is used for parallel track annunciation, it is recommended that the parallel track annunciator be labeled “PTK” in white text.

2.8.7.6 Suspend Annunciation

P5-63 Suspend Annunciate

The Suspend Annunciate output is grounded when automatic sequencing of waypoints in the active flight plan has been suspended (either manually by the user or automatically by the GNS 480).

If an external annunciator is used for suspend annunciation, it is recommended that the suspend annunciator be labeled “SUSP” in white text.

2.8.7.7 Message Annunciation

P5-64 Message Annunciate

The Message annunciator flashes when a new status message is available. If a status message has been acknowledged but is still effective, the Message annunciator illuminates continuously.

If an external annunciator is used for message annunciation, it is recommended that the message annunciator be labeled “MSG” in white or amber text.

2.8.7.8 LOI (Loss of Integrity) Annunciation

P5-65 LOI Annunciate

The LOI Annunciate output is grounded when the WAAS / GPS detects a position error, or is unable to calculate the integrity of the position (RAIM unavailable).

If an external annunciator is used for loss of integrity annunciation, the loss of integrity annunciator should be labeled “LOI” in amber text.

2.8.7.9 Waypoint Annunciation

P5-66 Waypoint Annunciate

The Waypoint annunciator functions as follows:

- When the aircraft is within 10 to 20 seconds of reaching a turning point for a course change, the waypoint annunciator flashes.
- When the aircraft is in a turn, the waypoint annunciator illuminates continuously and remains illuminated until the turn is completed.
- When the turn is complete and deviation information is being provided relative to the next leg, the waypoint annunciator will extinguish.

If an external annunciator is used for waypoint annunciation, it is recommended that the waypoint annunciator be labeled “WPT” in white text.

2.8.7.10 Terminal Mode Annunciation

P5-67 Terminal Mode Annc

The Terminal Mode Annc output is grounded when not in Approach mode, but navigating within 30 nmi of the departure or arrival airport, or on a SID or STAR.

If an external annunciator is used for terminal mode annunciation, it is recommended that the terminal mode annunciator be labeled “TERM” in green text.

2.8.7.11 Altitude Alert Annunciation

P5-69 Altitude Alert Annc

The Altitude Alert Annc output is grounded when all of the following conditions are true:

- performing a WAAS GPS approach with vertical guidance;
- on the approach inbound to the final approach fix (FAF); and
- ownship WAAS altitude more than (50 meters plus the vertical protection limit (VPL)) below the altitude at the FAF

If an external annunciator is used for altitude alert annunciation, it is recommended that the altitude alert annunciator be labeled “ALT” in amber text.

2.8.8 DISCRETE OUTPUTS

2.8.8.1 ILS Energize

P7-33 ILS Energize

The ILS Energize output is grounded whenever a localizer frequency is tuned on the GNS 480 nav radio, regardless of which navigation source (GPS or VOR/ILS) is currently selected to drive the CDI.

2.8.8.2 Precision Approach

P5-68 Precision Appr

The Precision Appr output is grounded when a precision approach is active. Currently, the precision approach output will be active when the GNS 480 nav radio is tuned to a localizer and the VOR/ILS radio navigation data is selected for display on the CDI. This output may be connected to the ILS Energize input of an autopilot or flight director to provide higher autopilot gain when the GNS 480 is operating in precision approach mode.

2.8.8.3 Audio Message Active Out

P5-70 Audio Msg Active Out

The Audio Msg Active Out is grounded whenever the GNS 480 is playing an audio message or audio tone. This output is grounded 200 msec prior to playing the message / tone, and remains grounded for 200 msec following completion of the message / tone.

2.8.8.4 Power Control Out

P7-36 Power Control Out

The Power Control Out is grounded whenever power is applied to the GNS 480, and open otherwise.

2.8.8.5 Discrete In / Out

P5-72 Discrete In/Out 1
P5-73 Discrete In/Out 2
P5-74 Discrete In/Out 3
P5-75 Discrete In/Out 4

The four Discrete In/Out's are software-configurable as inputs or outputs. These are general purpose inputs/outputs whose function depends upon what interfaces are configured on the GNS 480.

2.8.9 SWITCHES / DISCRETE INPUTS

NOTE

Installations in conformance with the requirements specified in this installation manual do not require the use of any external switches, since all switches are provided on the GNS 480 front panel.

All of the switch inputs duplicate functions available on the front of the GNS 480. These can be used to make the function available remotely.

2.8.9.1 CDI Select Switch

P7-8 Main CDI Select In

The Main CDI Select In is used to toggle between the display of GPS and VOR/ILS information on the CDI window and remote CDI connected to the Main CDI outputs. A momentary ground on this input performs the same function as pressing the **CDI** key on the GNS 480 bezel.

NOTE

If the GNS 480 is setup to IGNORE the CDI select key and discrete input (refer to 3.2.1.6) this input will not be functional.

2.8.9.2 Com Flip-Flop Switch

P1-14 Com Flip Flop In

The Com Flip Flop In is used to toggle the active and standby Com frequencies. A momentary ground on this input performs the same function as pressing the COM flip-flop soft key (↔) on the bezel.

2.8.9.3 VOR Flip-Flop Switch

P1-34 VOR Flip Flop In

The VOR Flip Flop In is used to toggle the active and standby VOR/LOC frequencies. A momentary ground on this input performs the same function as pressing the VOR flip-flop soft key (↔) on the bezel.

2.8.9.4 Push to Talk (PTT)

P4-4 PTT

The PTT is used to transmit on the COM radio. A ground on this input enables the Com MIC audio and causes the Com transceiver to transmit on the active frequency.

2.8.9.5 Com User List Switch

- P1-15 UP Discrete In
- P1-33 DOWN Discrete In

The Com User List inputs are momentary, active-low discrete inputs and are used to display the Com User List and select a frequency. When not displayed, a momentary grounding on either of these inputs causes the Com User List window to be displayed. When the Com User List window is displayed, a momentary ground on the UP Discrete In (P1-15) causes the highlighted frequency to move up to the next frequency in the list. A momentary ground on the DOWN Discrete In (P1-33) causes the highlighted frequency to move down to the next frequency in the list. Once selected, the frequency can be made active by pressing the Com Flip-Flop button.

2.8.9.6 Suspend Switch

- P5-76 Suspend In

The Suspend In input suspends automatic sequencing of waypoints in the active flight plan. A momentary ground on this input performs the same function as pressing the **SUSP** key on the GNS 480 bezel.

2.8.9.7 Audio Inhibit In

- P5-77 Audio Inhibit In

The Audio Inhibit In is used to inhibit the GNS 480 audio messages. A ground on this input causes GNS 480 audio messages not to be played; if this input is open GNS 480 audio messages will be played. Any audio messages that are inhibited because of this input will not be played when the audio inhibit condition is removed.

NOTE

The Audio Inhibit input will not inhibit the momentary tone that is played by the GNS 480 whenever a status message is available. This tone can be disabled by the user via the system configuration page.

2.8.10 SERIAL INTERFACES

2.8.10.1 RS232 / RS422

The GNS 480 provides five bi-directional RS232 serial interfaces, two receive-only RS232 serial interfaces and one bi-directional RS422 serial interface for making optional connections. The serial port can be used for connecting to:

- Resolvers, indicators, or electronic flight instruments that accept serial data
- SL30 for Comm/NAV frequency transfers and DME distance from the database
- MX20 to display VOR data on a map and database interface
- A second GNS 480

Serial interface specifications are included in Appendix B.

P1-4	RS232 RxD1	P5-1	RS232 RxD5
P1-5	RS232 TxD1	P5-21	RS232 TxD5
P1-23	Serial Ground 1	P5-41	Serial Ground 5
P1-21	RS232 RxD2	P5-2	RS232 RxD6
P1-22	RS232 TxD2	P5-22	RS232 TxD6
P1-3	Serial Ground 2	P5-42	Serial Ground 6
P1-7	RS232 RxD3	P5-10	RS232 RxD7
P1-6	RS232 TxD3	P5-30	RS232 RxD8
P1-25	Serial Ground 3	P5-44	Serial Ground 7/8
P1-11	RS422 RxD4 +	P7-5	RESERVED DB30 TxD
P1-26	RS422 RxD4 -	P7-3	Ground
P1-8	RS422 TxD4 +		
P1-10	RS422 TxD4 -		

NOTE

In order for a serial port to function correctly, the baud rate of the Rx and Tx channels on a given RS232 or RS422 port must be the same. This must be considered when assigning serial ports to interfacing equipment.

The GNS 480 can communicate with an SL30 radio using RS232 RxD1 and TxD1. This interface allows the SL30 to provide DME station information to the GNS 480, which will provide the range to the DME station back to the SL30 for display on its front panel.

The GNS 480 can communicate with a PDA using the infrared sensor on the front bezel. If this feature is used it must be set up on RxD3 and TxD3, not allowing these lines to be used for communication with other devices.

The GNS 480 can receive air data and fuel data from certain systems on RS232 RxD5, although it is recommended that if a dedicated altitude encoder is used, it be connected to RS232 RxD8.

If two GNS 480's are installed in an aircraft, the RS232 RxD2 and TxD2 lines may be cross connected to cross-fill flight plans and user-defined waypoints from one GNS 480 to the other (this feature is not implemented in the initial version of the GNS 480). Altitude data and master/slave control is coordinated between two GNS 480's.

The GNS 480 can communicate with an SL70 or SL70R transponder using the RS232 RxD6 and TxD6 lines, allowing the GNS 480 to control the operation of the transponder. This interface will also allow altitude to be provided from the SL70/70R to the GNS 480. RS232 channel 6 is opto-isolated, allowing the transmit lines of two GNS 480's to be connected together to either GNS 480 to control an SL70 transponder.

A dedicated altitude encoder may be used to provide altitude data to the GNS 480 using RS232 RxD8.

The GNS 480 can provide DME tuning data to the DB30 using a reserved transmit port. This reserved output cannot be configured.

Refer to section 3.2.1.1 for a list of available serial port configurations, and information on configuring the serial ports.

2.8.10.2 ARINC 429

The GNS 480 provides three ARINC 429 inputs and two ARINC 429 outputs. Each of these may be configured for low-speed or high-speed operation.

2.8.10.2.1 ARINC 429 Inputs

- P5-7 429 IN 1A
- P5-27 429 IN 1B
- P5-8 429 IN 2A
- P5-28 429 IN 2B
- P5-9 429 IN 3A
- P5-29 429 IN 3B

The GNS 480 can receive air data, heading data, wind data, traffic data and selected course from suitable equipment. The labels that are used by the GNS 480 depend upon the port configuration. Below is a list of available input configurations and the labels accepted by each one:

1. ADC
2. AHRS
3. EFIS *(software version 1.3 and later)*
4. SKYWATCH *(software version 2.0 and later)*
5. SKYWATCN NO UI *(software version 2.0 and later)*

NOTE

Not all configurations are available for each input channel. Refer to section 3.2.1.2 to determine which configurations are available for each ARINC 429 input channel.

Table 2-9 - ARINC 429 Input Labels

Label No.	Parameter Name	1	2	3	4	5
100	Selected Course			•		
130	Intruder Range				•	•
131	Intruder Altitude (relative)				•	•
132	Intruder Bearing Estimate				•	•
203	Pressure Altitude	•	•	•		
204	Baro Corrected Altitude	•	•	•		
210	True Airspeed	•	•	•		
212	Pressure Altitude Rate	•	•	•		
270	Vertical RA Data Output				•	•
274	Selected Sensitivity Level				•	•
314	Heading (True)	•	•	•		
315	Wind Speed	•	•	•		
316	Wind Direction (True)	•	•	•		
320	Heading (Magnetic) [1]	•	•	•	•	•
350	Maintenance				•	•
357	RTS / ETX				•	•

Notes:

[1] For configurations 4 and 5, label 320 magnetic heading is only used for traffic display purposes.

Refer to section 3.2.1.2 for information on configuring the ARINC 429 inputs.

2.8.10.2.2 ARINC 429 Outputs

- P5-4 429 OUT 1A
- P5-24 429 OUT 1B
- P5-5 429 OUT 2A
- P5-25 429 OUT 2B

The data output on the ARINC 429 output port depends upon the configuration (refer Table 2-10). Below is a list of the possible configurations and the labels output for each one.

1. EFIS 429 *(software version 1.2 and earlier)*
2. ARINC 429 *(software version 1.3 and later)*
3. GAMA 429 No FP *(software version 1.3 and later)*
4. VOR/ILS *(software version 1.3 and later)*
5. ARINC 743A *(software version 2.0 and later)*

NOTE
The GAMA 429 No FP configuration does not contain flight plan information.

Table 2-10 - ARINC 429 Output Labels

Label No.	Parameter Name	1	2	3	4
001	Distance To Go (BCD)	•	•	•	
002	Time To Go (BCD)	•	•	•	
012	Ground Speed (BCD)	•	•	•	
034G	VOR/ILS Frequency (BCD)				•
035G	DME Frequency (BCD)				•
041	Set Latitude (BCD)			•	
042	Set Longitude (BCD)			•	
074G	Data Record Header			•	
075G	Active Wpt From/To Data			•	
100	Selected Course 1	•	•		
100G	Selected Course 1			•	
113G	Message Checksum			•	
114	Desired Track (True)	•	•	•	
115	Waypoint Bearing (True)	•	•	•	
116	Cross Track Distance [Note 1]	•	•		
116G	Cross Track Distance			•	
117G	Vertical Deviation [Note 5]		•	•	
121	Horizontal Command (To Autopilot)	•	•	•	
125	Greenwich Mean Time (BCD)	•	•	•	
147G	Magnetic Variation		•	•	
150	UTC (Binary)				
173	Localizer Deviation [Note 2]				•
174	Glideslope Deviation [Note 3]				•
204	Baro Corrected Altitude	•	•		
222	VOR Omnibearing (From aircraft to station)				•
251	Distance To Go	•	•		

Label No.	Parameter Name	1	2	3	4
251G	Distance To Go			•	
252	Time To Go			•	
260G	Date (BCD)			•	
261G	GPS Discrete Word 1			•	
275G	LRN Status Word 1			•	
300G	Station Declination, Type, and Class			•	
303G	Message Length/Type/Number			•	
304G	Message Characters 1-3			•	
305G	Message Characters 4-6			•	
306G	NAV/Waypoint/Airport Latitude			•	
307G	NAV/Waypoint/Airport Longitude			•	
310	Present Position Latitude	•	•	•	
311	Present Position Longitude	•	•	•	
312	Ground Speed	•	•	•	
313	Track Angle (True)	•	•	•	
314	True Heading	•	•	•	
315	Wind Speed	•	•	•	
316	Wind Angle (True)	•	•	•	
320	Magnetic Heading	•	•	•	
321	Drift Angle	•	•	•	
326G	Lateral Scale Factor	•	•	•	
327G	Vertical Scale Factor [Note 5]		•	•	
351G	Distance To Destination (Via Flight Plan)			•	
352G	Estimated Time To Destination (Via Flight Plan)			•	
371G	Specific Equipment ID [Note 4]			•	•
377	Equipment Hex ID Code [Note 4]	•	•	•	•

Notes:

- [1] Label 116 is not properly encoded in the GNS 480 Software Version 1.0, 1.1, and 1.2. Equipment using this label should not be interfaced via ARINC 429 to a GNS 480 with one of these software versions.
- [2] Binary DDM for localizer deviation is limited to ± 0.155 .
- [3] Binary DDM for glideslope deviation is limited to ± 0.175 .
- [4] The GNS 480 Equipment Hex ID is 002 for configurations 1, 2, and 5. For configuration 4, the Hex ID is 010 when a localizer is tuned, and 011 when a VOR is tuned.
- [5] Vertical deviation and scale factor (labels 117G and 327G) were added to the outputs as part of GNS 480 Software Version 2.0 and do not exist in version 1.3.

Table 2-10A11 - ARINC 429 Output Labels – Configuration 5 (ARINC 743A)

Label No.	Parameter Name	5
076	GNSS Altitude (MSL)	●
101	HDOP	●
102	VDOP	●
103	GNSS Track Angle	●
110	GNSS Latitude	●
111	GNSS Longitude	●
112	GNSS Ground Speed	●
120	GNSS Latitude Fine	●
121	GNSS Longitude Fine	●
125	UTC Time Of Day [BCD]	●
130	Horizontal Protection Level	●
133	Vertical Protection Level	●
136	Vertical Figure of Merit	●
140	UTC Fine	●
141	UTC Fine Fractions	●
150	UTC Time Of Day	●
165	Vertical GPS Velocity	●
166	North/South Velocity	●
174	East/West Velocity	●
247	Horizontal Figure of Merit	●
260	Date [BCD]	●
273	GNSS Sensor Status	●
355	GNSS Fault Summary	●
370	GNSS Height (HAE)	●
377	Equipment Hex ID Code (0Bh)	●

Refer to section 3.2.1.2 for information on configuring the ARINC 429 outputs.

2.8.11 TIME MARK OUTPUT

- P1-17 Time Mark Out +
- P1-19 Time Mark Out -

The Time Mark Out is a differential output that provides a 1 msec pulse once each second. This time reference is derived from GPS satellites.

2.8.12 VHF COM

The GNS 480 provides an internal COM transceiver that can be interfaced to an audio panel or connected directly to a speaker. The PTT input is used to enable the Com MIC audio and cause the Com transceiver to transmit on the active frequency. Optional external inputs are available to allow the user to toggle the active and standby Com frequencies, and select Com frequencies from a user-defined frequency list.

Refer to Appendix D for interconnect information.

Refer to section 3.2.1.5 for information on setting the RF squelch and mic gain values.

2.8.12.1 Com Headphone and Speaker Audio Out

- P4-14 Com Headphone Out
- P4-6 Com Speaker Out
- P4-13 Com Audio Ground

The Com Headphone Out is a low-level audio output that is intended to drive a headset or audio panel. This output will provide 280 mW into a 100 Ω load, or 120 mW into a 500 Ω load.

The Com Speaker Out is a high-level audio output that is available to drive a speaker. This output will provide 12 watts into a 4 Ω load, or 8 watts into an 8 Ω load.

Both the Headphone and Speaker outputs use the same Com Audio Ground. For normal installations, it is recommended that the Headphone output be used, and the Com Speaker output be left unconnected.

2.8.12.2 Com MIC Audio In

- P4-8 Com MIC In High
- P4-7 Com MIC In Low

The Com MIC input is designed for a standard carbon or dynamic mic with integrated pre-amp providing minimum 70 mv rms into 1000 Ω load. The GNS 480 provides a bias voltage to the microphone.

2.8.12.3 Push to Talk (PTT)

- P4-4 PTT

The PTT is used to enable the Com MIC audio and cause the Com transceiver to transmit on the active frequency. Refer to section 2.8.9.4 for additional details.

2.8.12.4 Com Flip-Flop Switch

- P1-14 Com Flip Flop In

The Com Flip-Flop In can be used to toggle the active and standby Com frequencies. Refer to section 2.8.9.2 for additional details.

2.8.12.5 Com User List Switch

- P1-15 UP Discrete In
- P1-33 DOWN Discrete In

The Com User List inputs can be used to display the Com User List and select a frequency. Refer to section 2.8.9.5 for additional details.

2.8.13 VHF NAV

The GNS 480 provides an internal NAV receiver that can be interfaced to an audio panel. An optional external input is also available to allow the user to toggle the active and standby Nav frequencies.

Refer to Appendix D for interconnect information.

2.8.13.1 Nav Audio Out

P7-23 NAV Audio Out
P7-20 NAV Audio Ground

The NAV Audio Out is a low-level audio output that is intended to drive a headset or audio panel. This output will provide 100 mW into a 500 Ω load.

2.8.13.2 VOR Flip-Flop Switch

P1-34 VOR Flip Flop In

The VOR Flip Flop In is used to toggle the active and standby VOR/LOC frequencies. Refer to section 2.8.9.3 for additional details.

2.8.14 MESSAGE AUDIO

The GNS 480 provides a message audio output for aural advisory messages. This output also provides an optional tone to alert the user when a new status message is available. A discrete input is also provided to allow these audio messages to be inhibited by higher priority systems.

Refer to Appendix D for interconnect information.

2.8.14.1 Message Audio Out

P5-40 Message Audio Out
P5-43 Message Audio Gnd

The Message Audio Out is a low-level audio output that is intended to drive a headset or audio panel. It is recommended that this input be provided to an auxiliary input in the audio panel that will allow the user to switch off the message audio if desired. This output will provide 100 mW into a 500 Ω load.

2.8.14.2 Audio Inhibit In

P5-76 Audio Inhibit In

The Audio Inhibit In may be used by higher priority systems to inhibit the GNS 480 audio messages. Refer to section 2.8.9.7 for additional details.

2.8.15 RMI / OBI

The GNS 480 RMI/OBI output can be used to drive an RMI (or OBI) navigation indicator. The OBI Select input is used to select the source (GPS or Nav radio) used to provide the bearing.

Refer to Appendix D for interconnect information.

2.8.15.1 RMI / OBI Interface

P5-16 OBI Clock
P5-17 OBI Data
P5-37 OBI Sync

The GNS 480 provides bearing from a waypoint for Bendix / King Serial OBI devices. The source used to provide the bearing information is selected by the OBI Select input.

2.8.15.2 RMI / OBI Source Select

P5-36 OBI Select In

When the OBI Select input is open, the bearing data transmitted on the RMI / OBI output is bearing from the currently active GPS waypoint. When the OBI Select input is grounded, the bearing data transmitted on the RMI / OBI output is bearing from the currently tuned VOR station. If a localizer channel is tuned on the GNS 480 Nav receiver, the bearing data is flagged as invalid.

2.8.16 DME TUNING

The GNS 480 can channel a DME based upon the tuned VOR frequency. The GNS 480 outputs the King Serial DME channeling format. When the DME Select input is grounded, the GNS 480 will actively tune the DME.

Refer to Appendix D for interconnect information.

2.8.16.1 Serial DME Tuning

P5-14 DME Clock Bus
P5-15 DME Data Bus
P5-35 DME Channel Req

When the DME Channel Request line is high, the GNS 480 provides serial DME channeling data on the DME Clock / Data Buses. Data is provided in the King Serial DME channeling format.

2.8.16.2 DME Select In

P5-34 DME Select In

When grounded, the GNS 480 will acknowledge a DME channel request and output data on the DME Serial Tuning interface. When open, the GNS 480 will not provide tuning information.

2.9 ANTENNA INSTALLATION AND CONNECTIONS

The GNS 480 requires three antennas: Com antenna, GPS antenna, and Nav antenna. Follow the manufacturer's installation instructions for mounting the antennas.

2.9.1 COMM ANTENNA

The GNS 480 requires a standard 50Ω vertically polarized antenna. Follow the antenna manufacturer's installation instructions for mounting the antenna.

The antenna should be mounted on a metal surface or a ground plane with a minimum area of 18 x 18 inches. The antenna should be mounted a minimum of two feet away from GPS antennas.

The comm antenna should also be mounted as far apart as practical from the ELT antenna, preferably one on top and the other on the bottom of the aircraft fuselage. Some ELTs have exhibited re-radiation problems generating harmonics that may interfere with GPS signals. This can happen when the comm (GNS 480 or any other comm) is transmitting on certain frequencies such as 121.15 or 121.175 MHz, which may cause the ELT output circuit to oscillate from the signal coming in on the ELT antenna coax. The antenna coax cable should be made of RG-142B or a comparable quality 50Ω coax. Assembly instructions for the rear coax connector are included in Figure 2-11.

2.9.2 GPS ANTENNA

The mounting location and cable connections for the GPS antenna are very important. The antenna should be mounted no closer than two feet from VHF comm transmitter antennas, six inches from other antennas emitting less than 25 watts, and two feet from higher power antennas. See A-33 GPS Antenna Installation Manual, p/n 560-0949-xx for more information on GPS antenna installation. Special care should be taken to ensure that the GPS antenna is not mounted in close proximity to antennas that may emit harmonic interference at the L1 frequency of 1575.42 MHz. Refer to AC 20-138A Airworthiness Approval of Global Navigation Satellite System (GNSS) Equipment for additional information and guidelines.

NOTE

The internal GNS 480 Com does not interfere with its own GPS receiver. However, placement of the GNS 480 GPS antenna relative to other com transceivers and antennas (including the GNS 480 Com antenna) is critical.

The connectors are included in the installation kit, and are intended for use with RG-142B size coax cable. If using a different diameter coax, alternative connectors may be required. Assembly instructions for the connectors are included in Figure 2-11. RG-142B cable can be used as long as the length is less than 35 feet. For longer lengths, use low-loss 50Ω coax.

Suggestion: Temporarily locate the GPS antenna with coax connected to the GNS 480 and check the GPS performance as described in the GPS Operation and Position test in the Post Installation Checkout in section 3.3.2.1.2. Once a suitable location has been verified, then permanently mount the antenna.

NOTE

If using a GPS antenna that was already on the aircraft, or if mounting the antenna closer than two feet from a comm antenna, conduct the GPS Operation and Position test in the Post Installation Checkout on page 3-31. If the GNS 480 passes the test, then further measures are not necessary.

Once the antenna mounting position has been prepared, route the coax cable from the antenna to the GNS 480. Proper selection of coax cable and assembly of connectors is critical to GPS signal performance. The cable loss from the GPS antenna shall not be greater than 7 dB. If SatCom is installed on the aircraft, the cable loss shall be 3 dB minimum to ensure proper interference rejection from SatCom. The coaxial connectors and adapters, such as TNC to BNC, add additional loss to the cable and should be considered when computing the cable loss. A typical loss of 0.2 dB can be used for each connection. The typical cable loss for 20 feet of RG-142B coax with a connector on each end is 4 dB.

During the post-installation checkout, susceptibility to harmonics of VHF comm transmitters will be evaluated. If problems arise, then better isolation, or distance, may be required between the GPS and comm antennas, or a 1575.42 MHz notch filter may be installed in series with the antenna coax of the VHF comm transceiver to reduce or eliminate the harmonic interference. A notch filter for this use (part #162-1059) is available from Garmin AT.

NOTE

GNS 480 performance has been verified in typical installations and has not shown problems of the built-in comm interfering with the GPS when installed according to the recommended installation guidelines.

If a VHF comm transmitter causes problems with the GPS on the selected frequencies as listed in the post-installation checkout, the problem may be due to the ELT. This can be verified by disconnecting the ELT antenna coax at the ELT unit. If the ELT is found to cause the problem, then contact the ELT manufacturer or replace the ELT.

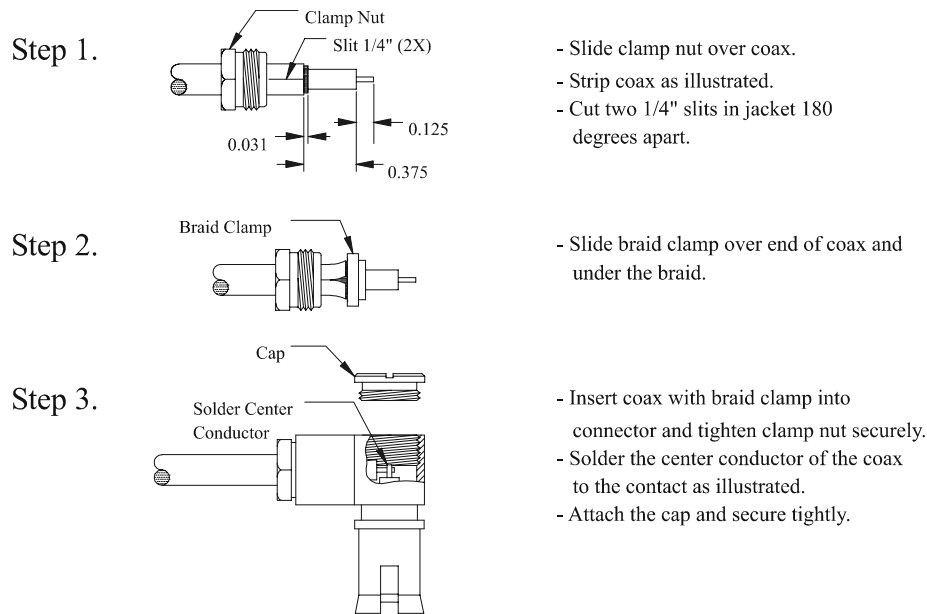

Assembly instructions for right angle connector part #162-1008

Figure 2-11 - Rear Coax Connector Assembly

2.9.3 NAV ANTENNA

The NAV antenna is a standard 50Ω horizontally polarized NAV/VOR/Localizer/Glideslope antenna that receives VOR frequencies between 108 and 117.95 MHz, and localizer frequencies between 108 and 112 MHz, and glideslope information between 328.6 and 335.4 MHz. Follow the antenna manufacturer's installation instructions for mounting antennas. The Nav antenna should be mounted as far apart as

practical from the ELT antenna. It is recommended that the installer use RG-142B or equivalent 50Ω coax for the NAV antenna.

The GNS 480 incorporates an internal diplexor circuit. This means that the input VHF signal must not strip the glideslope (330 MHz) signal from the NAV (108 MHz) signal. **Do not install an external diplexor.** It is recommended that a single VOR/Localizer/Glideslope antenna be used for the installation. Most VOR/LOC-only antennas will still provide an adequate glideslope signal for the GNS 480 to operate normally.

If two nav receivers (e.g. one GNS 480 and one SL30) are installed in the aircraft, a splitter must be used. Installations should use an appropriate splitter, such as the Mini-Circuits ZFSC-2-1B BNC, available as an option under the Garmin AT part number 115-0007.

2.10 WEIGHT AND BALANCE

Weight and balance computation is required after the installation of the GNS 480. Follow the guidelines as established in AC 43.13-1B, Chapter 10, section 2. Make appropriate entries in the equipment list indicating items added, removed, or relocated along with the date accomplished. Include your name and certificate number in the aircraft records. Table 2-12 identifies the weight of the new GNS 480 equipment and Figure 2-12 shows the center of gravity.

Table 2-12 - Unit Weights	
Item	Weight
GNS 480 only	5.8 lbs. (2.6 kg)
GNS 480 mounting tube only	0.7 lbs. (0.3 kg)

2.11 ELECTRICAL LOAD ANALYSIS

An electrical load analysis should be completed on each aircraft prior to installation in accordance with AC 43.13-1B, Chapter 11. Use the following values for computation:

Table 2-13 - Unit Power Loads				
GNS 480 Input	14 VDC		28 VDC	
	Typical	Max	Typical	Max
GNS 480 Main Power (P1 connector)				
with heater off ⁽¹⁾	1.4 A	2.2 A	700 mA	1.1 A
with heater on ⁽¹⁾	2.4 A	3.2 A	1.2 A	1.6 A
GNS 480 Nav Power (P7 connector)	450 mA	700 mA	200 mA	350 mA
GNS 480 Com Power (P4 connector)				
receive	270 mA	350 mA	130 mA	175 mA
transmit	2.1 A	3.2 A	1.0	1.6
Notes:				
(1) Backlight heater element turns on when internal temperature is below approximately 42°C.				

NOTE
Circuits should be protected in accordance with guidelines in AC 43.13-1B, chapter 11, section 2, paragraph 429. Power inputs should be across a minimum of all four specified input pins.

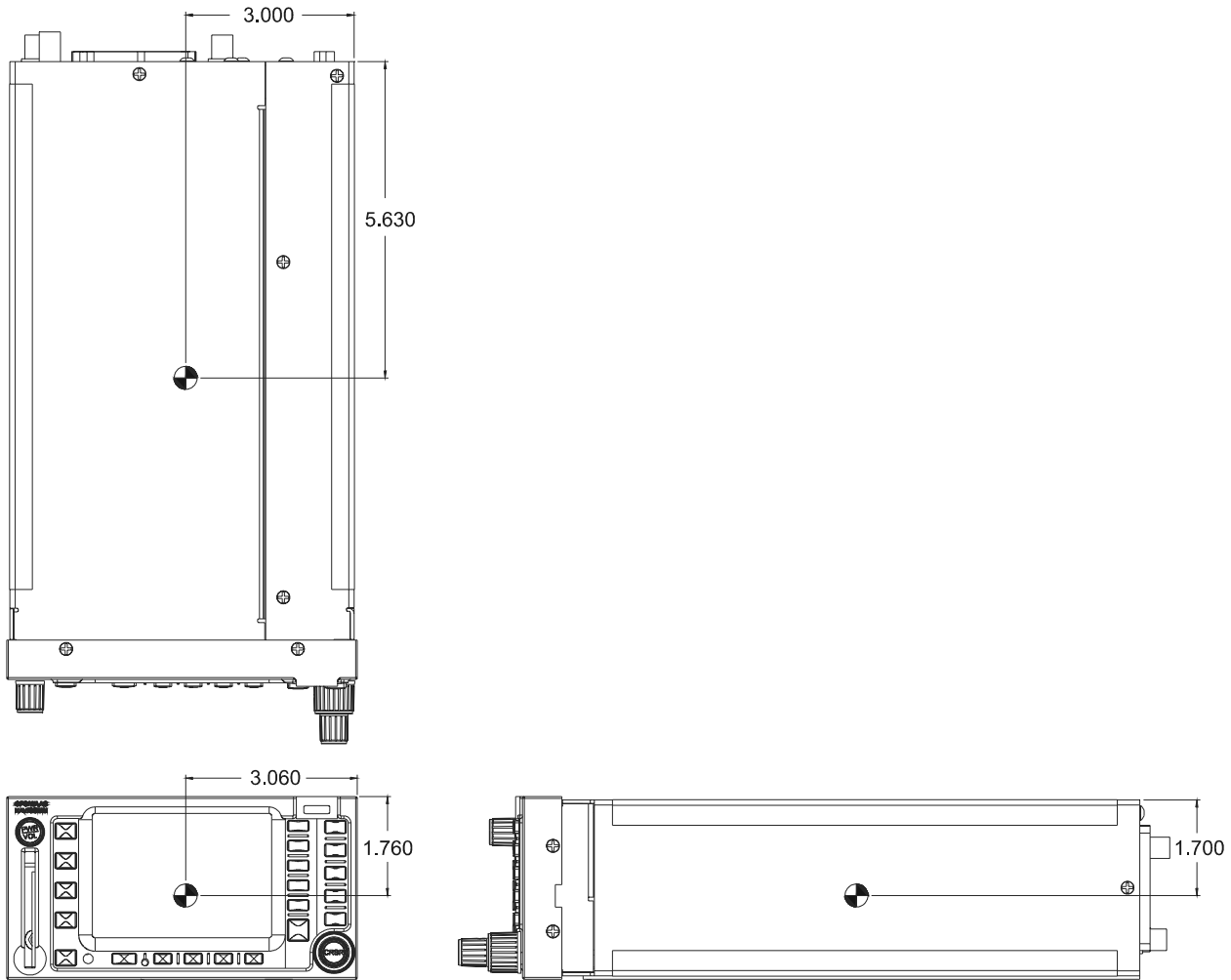

Figure 2-12 - GNS 480 Center of Gravity

3 POST INSTALLATION CONFIGURATION & CHECKOUT PROCEDURES

Once the GNS 480 unit has been installed, configure the unit for the particular installation and then complete the checkout procedures herein to verify proper operation. The steps that are not applicable to a particular installation may be skipped. A checkout log sheet is included in Table 3-7 on page 3-43, to be filled out during the checkout procedure. The completed checkout log sheet should be maintained with the aircraft permanent records.

3.1 MOUNTING AND WIRING CHECK

Verify that all cables are properly secured and shields are connected as the install drawings indicate. Installation may require that you check the movement of the aircraft controls to verify that there is no interference.

3.2 EQUIPMENT SETUP AND CONFIGURATION

Prior to system operation, the GNS 480 must be configured for the particular installation using the setup functions provided.

The system setup and checkout functions are reached in the Ground Maintenance mode of the GNS 480. This mode should not be accessed during flight. The Ground Maintenance mode is reached by pressing the line select keys 1, 4, and **MENU/ENTER** in sequence immediately after the GNS 480 initialization is complete and before any other bezel keys on the GNS 480 are pressed. Line select key 1 is the top line select key, line select key 4 is the fourth key down, and **MENU/ENTER** is the lower most key below the line select keys. After pressing the keys, wait for the GNS 480 to restart into Ground Maintenance mode. The Ground Maintenance mode default menu display (SETUP) is shown in Figure 3-1. Pressing the **SETUP**, **TEST** or **INPUT** smart keys along the bottom allows selection of that function. Pressing the **EXIT** smart key will return the GNS 480 to the Airborne mode.

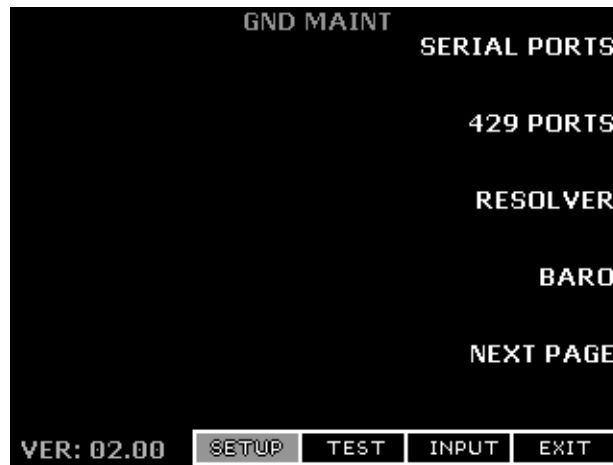

main page

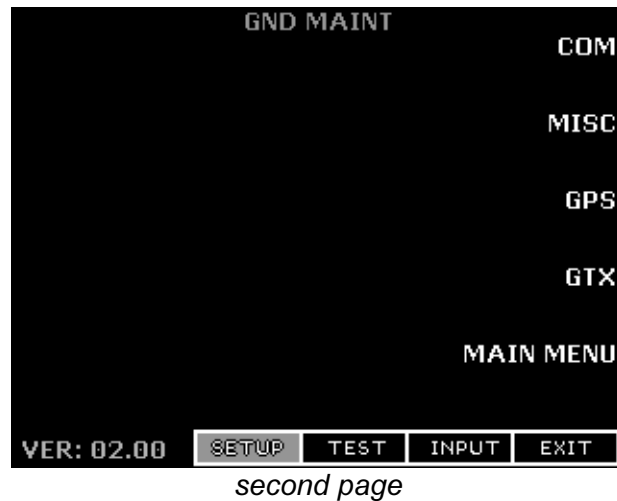

Figure 3-1 - Ground Maintenance Mode Display

3.2.1 SETUP FUNCTION

The SETUP function allows the custom configuration of the GNS 480 for each individual installation. The SETUP function allows the installer to configure the serial and ARINC 429 ports, calibrate the resolver head (if installed), calibrate the baro potentiometer (if installed), and set COM parameters.

3.2.1.1 Serial Ports

While on the Ground Maintenance SETUP menu page, press the **SERIAL PORTS** line select key to change the serial port settings. The serial port setup page is shown in Figure 3-2.

GND MAINT SERIAL SETUP				
CH	RX	BAUD	TX	BAUD
1	MAPMX	38400	MAPMX	38400
2	CNX80	38400	CNX80	38400
3	IRDA	19200	IRDA	19200
4	NONE	0	NONE	0
5	SL30	9600	NONE	0
6	GTX33	9600	GTX33	9600
7	COG	9600	---	---
8	ALT ENC	1200	---	---

Figure 3-2 - Serial Port Setup Page

Push the small, inner knob in to enter the editing mode. The first editable item will be highlighted. Use the large, outer knob to select the next or previous editable data field and turn the small, inner knob to change the current setting. Set each serial port according to the installation, and leave unused ports set to NONE. Either press the small, inner knob in again or press the **MENU/ENTER** key to save the settings. Press the **SETUP** or **BACK** smart key to return to the Ground Maintenance SETUP menu. The configuration options for the serial input ports and output ports are shown in Table 3-1.

NOTE

In order for a serial port to function correctly, the baud rate of the RX and TX channels on a given RS232 or RS422 port must be the same (or the unused channel must be set to NONE). This must be considered when assigning serial ports to interfacing equipment.

Table 3-1 - Serial Port Setup Configurations

Serial Port	Default Configuration		Other Available Configurations	
	Rx	Tx	Rx	Tx
1 [1]	MAPMX (38400)	MAPMX (38400)	FADC (9600), SL30 (9600), None	MAPCOM (9600), None
2 [3]	FADC (9600)	MAPCOM (9600)	CROSSFILL (38400), None	CROSSFILL (38400), None
3 [2]	IrDA (9600-115200)	IrDA (9600-115200)	None	None
4	None	None		
5	SL30 (9600)	MAPCOM (9600)	Alt Enc. (1200, 9600), FADC (9600), None	MAPCOM (9600), None
6 [4]	SL70 (9600)	SL70 (9600)	GTX32 (9600), GTX33 (9600), GTX33+TIS (9600), None	GTX32 (9600), GTX33 (9600), GTX33+TIS (9600), None
7	None	---	COG (9600)	---
8	Alt Enc. (1200, 9600)	---	None	---

Notes:

- [1] MAPMX is a special format for use with the MX20 Version 5 (or later). MAPCOM refers to the standard Garmin AT serial output.
- [2] Although the IrDA option is shown for port 3, this interface is currently not supported.
- [3] The CROSSFILL configuration is used to allow GNX 480's to share information in a dual GNS 480 installation.
- [4] If SKYWATCH or SKYWATCH NO UI is set up on an ARINC 429 input, the GTX33+TIS option will not be available.

3.2.1.2 ARINC 429 Ports

While on the Ground Maintenance SETUP menu page, press the **429 PORTS** line select key to configure the ARINC 429 ports. The ARINC 429 ports setup page is shown in Figure 3-3.



Figure 3-3 - ARINC 429 Ports Setup Page

Push in the Cursor knob to allow editing of the settings. Turn the large, outer knob to select the next or previous item and the Cursor knob to change currently selected setting. Set each ARINC 429 port according to the installation, and leave unused ports set to NONE. Either press the Cursor knob in again or press the **MENU/ENTER** key to save the settings. Press the **SETUP** or **BACK** smart key to return to the Ground Maintenance SETUP menu. The available ARINC 429 input and output port settings are shown in Table 3-2, and the definition of each available configuration is found in section 2.8.10.2.

The Source Destination Identifier (SDI) field on the EFIS ARINC 429 input can be configured as SYS 1 or SYS 2 and should be set according to which system (#1 or #2) the GNS 480 is in a particular installation. However, other inputs (ADC, AHRS) are accepted regardless of the SDI, and are indicated with ALL in the SDI column (the value of ALL cannot be changed).

The SDI field on the ARINC 429 outputs can be configured as SYS 1, SYS 2, or ALL. For dual GNS 480 installations, each GNS 480 must have a unique source name (SYS 1 or SYS 2). For a single GNS 480 installation, select ALL.

Table 3-2 - ARINC 429 Input and Output Port Settings

Channel	Speed	Data Settings Available
429_IN_1	Low	ADC / NONE
429_IN_2	High / Low	AHRS / EFIS / NONE
429_IN_3	High	SKYWATCH / SKYWATCH NO UI / NONE
429_OUT_1	High / Low	ARINC 429 / GAMA 429 NO FP / VOR/ILS / ARINC 743 / NONE
429_OUT_2	High / Low	ARINC 429 / GAMA 429 NO FP / VOR/ILS / ARINC 743 / NONE

NOTE

If GTX33+TIS is set up on an RS232 serial port, the SKYWATCH and SKYWATCH NO UI options will not be available on the ARINC 429 inputs.

3.2.1.3 Resolver Interface Selection and Calibration

The Resolver Interface function lets you to select whether or not a resolver is installed, and allows an installed resolver to be calibrated. While on the Ground Maintenance SETUP menu page, press the **RESOLVER** line select key. Then press the top line select key to toggle between INSTALLED (for installations with a resolver) or NOT INSTALLED (for installations without a resolver). The resolver interface setup page is shown in Figure 3-4.



Figure 3-4 - Resolver Interface Setup Page

When a resolver is installed, calibrate it as follows:

1. Press the **CAL** line select key. The calibration page shown in Figure 3-5 will then be displayed. If the **CAL** line select key is pressed when the resolver is set to NOT INSTALLED, it will automatically be changed to INSTALLED.
2. Press the **10/30** line select key to toggle between 10 and 30 degrees for the calibration increment.

NOTE

An increment of 30 degrees should be acceptable for most installations. However, if resolver errors of more than two degrees are present following the calibration, the calibration procedure should be repeated using the 10 degree increment (this will create a more accurate calibration table but will require more time to perform the calibration).

3. Follow the instructions on the display for calibrating the resolver. If the GNS 480 will not accept the calibration or advances to the next prompt when the **MENU/ENTER** key is pressed, there may be a problem with the resolver interface.

NOTE

The accuracy of the system is dependent on this calibration. Do not rush this step.

4. After successfully calibrating the resolver a green CALIBRATION PASSED message will be displayed. After this message appears, rotate the resolver and ensure that the CURRENT RESOLVER VALUE being displayed is within two degrees of the actual resolver setting.



Figure 3-5 - Resolver Calibration Page

The GNS 480 cannot drive multiple resolvers at the same time. It is not recommended that external resolvers be switched through a relay or other means because the resolver must be calibrated to the radio as described in this procedure. If multiple resolvers are desired in the installation, the primary unit must be installed and calibrated as described here. The secondary unit should use the composite output.

NOTE

The composite output is limited to the VHF Nav signal and will not be switched to GPS when the **CDI** bezel key is pressed.

3.2.1.4 Baro Interface

The Baro Interface function lets you to select whether or not a baro-correction potentiometer is installed, and allows an installed potentiometer to be calibrated. It also provides an option to disregard the baro correction and baro-corrected altitude from an FADC, which may be desirable in certain installations. While on the Ground Maintenance **SETUP** menu page, press the **BARO** line select key. Press the top line select key to toggle between **INSTALLED** (for installations with a baro pot) or **NOT INSTALLED** (for installations without a baro pot). Press the **FADC** line select key to toggle between **USE** (for installations where the baro data from the FADC will be used) or **IGNORE** (for installations where the baro data from the FADC will not be used). The Baro Interface setup page is shown in Figure 3-6.

NOTE

Due to priorities of incoming data (refer to 2.5.2.3), the FADC baro data will be used before that of the MX20. If it is desired not to use the baro-correction feature of the FADC source, the FADC **BARO/ALT** setting should be set to **IGNORE**.

The units that are used may be set using the **UNITS** line select key to toggle the units between inches Hg and millibars.

NOTE

Changing the units will only affect the units displayed during calibration. The user can change the units that are displayed during normal operation via the system configuration page.



Figure 3-6 - Altimeter Interface

When a baro potentiometer is installed, calibrate it as follows:

1. Press the **CAL** line select key. The calibration page shown in Figure 3-7 will then be displayed. If the **CAL** line select key is pressed when the baro pot is set to NOT INSTALLED, it will automatically be changed to INSTALLED.
2. Follow the instructions on the display for calibrating the baro potentiometer. If the GNS 480 will not accept the calibration when the **MENU/ENTER** key is pressed, there may be a problem with the baro potentiometer interface.

NOTE
The accuracy of the system is dependent on this calibration. Do not rush this step.

3. After successfully calibrating the baro potentiometer a green CALIBRATION PASSED message will be displayed. After this message appears, rotate the baro potentiometer and ensure that the CURRENT BARO value being displayed is within ± 0.03 "Hg (± 1 mB) of the actual altimeter setting.



Figure 3-7 - Baro-Altitude Calibration

3.2.1.5 Com Radio

The Com Radio Setup function is used to modify the RF Squelch and Mic Gain levels. Typical values from the factory are RF Squelch = 56 and Mic Gain = 255, which are satisfactory for most installations.

The RF Squelch value is used by the Com function to control its squelch level. The larger the value that is set the stronger the signal must be in order for the radio to break squelch. To edit the RF Squelch value, press the **EDIT RF SQUELCH** line select key. Turn the small, inner knob to adjust the squelch value (the RF Squelch value is restricted to a number from 25 to 100). When the desired value is selected, press the **MENU/ENTER** key or the **SAVE RF SQUELCH** line select key to save the setting.

The microphone gain is used by the Com function to control the microphone pre-amplifier gain. The larger the value that is set the higher the pre-amplifier gain is. To edit the Mic Gain value press the **EDIT MIC GAIN** line select key. Turn the small, inner knob to adjust the gain value (the Mic Gain value is restricted to a number from 0 to 255). When the desired value is selected, press the **MENU/ENTER** key or the **SAVE MIC GAIN** line select key to save the setting.



Figure 3-8 - Com Radio Setup

3.2.1.6 Miscellaneous Setup Items

The Misc Setup function is used to configure the unit to ignore the CDI select bezel key and CDI select discrete input (refer to 2.8.9.1). While on the Ground Maintenance SETUP menu Page 2, press the **MISC** line select key. Press the **CDI SEL** line select key to toggle between USE (for installations that will utilize the GNS 480 CDI bezel key to switch between Nav and GPS) or IGNORE (for installations where it is desired that the CDI bezel key be inoperative). If the CDI Select is set to IGNORE, the field beside the CDI key will always be GPS, regardless of CDI key presses. When set to IGNORE, the main analog CDI output (refer to 2.8.2) will always output VOR/ILS information, even though GPS information will be displayed in the CDI window and 'GPS' will be annunciated beside the CDI key. The Misc Setup page is shown in Figure 3-9.

NOTE

It may be necessary to disable (IGNORE) the GNS 480 CDI select key for installations with certain EFIS systems, where the navigation sensor selection must be accomplished on the EFIS or its control panel.



Figure 3-9 - Miscellaneous Setup Items

3.2.1.7 GPS Vertical Offset Setup

The GPS Vertical Offset setup function is used to enter the height above ground of the GPS antenna. Prior to proceeding, measure the GPS antenna vertical offset (to the nearest foot) as shown in Figure 3-10.

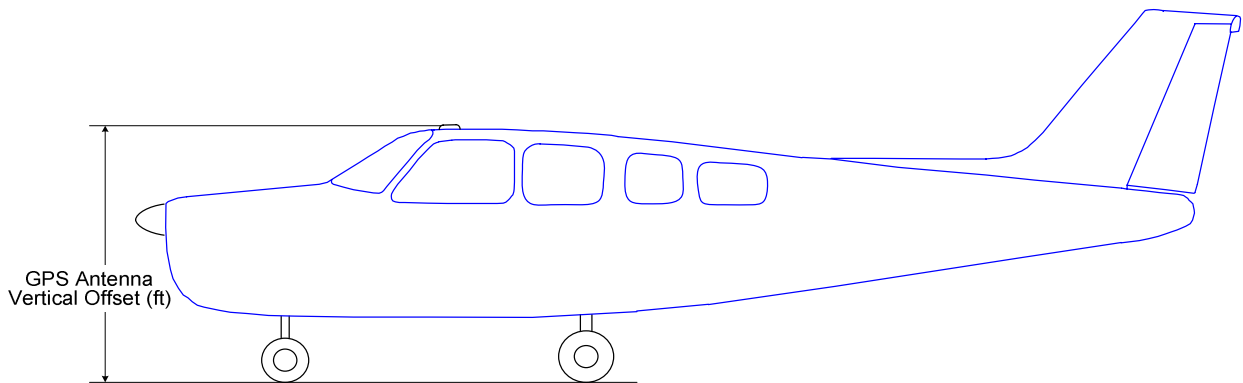

Figure 3-10 – Measurement of GPS Vertical Offset

While on the Ground Maintenance SETUP menu Page 2, press the **GPS** line select key. The GPS Vertical Offset setup page is shown in Figure 3-11.



Figure 3-11 – GPS Vertical Offset Setup Page

Push in the Cursor knob to allow editing of the offset value. Turn the Cursor knob to change the offset value, and set it to the value that was measured according to Figure 3-10. Either press the Cursor knob in again or press the **MENU/ENTER** key to save the settings. Press the **SETUP** or **BACK** smart key to return to the Ground Maintenance SETUP menu.

3.2.1.8 GTX Transponder Setup Items

The GTX Setup function is used to configure the GTX transponder – if no GTX transponder is setup, this menu choice will not be displayed. The menu that is displayed when the **GTX** line select key is pressed depends upon what version of GTX transponder is configured on serial port 6 (refer to 3.2.1.1). The GTX Main Setup menu is shown in Figure 3-12.

NOTE

Refer to the appropriate GTX transponder installation manual for a additional information on the parameters that can be configured via the GNS 480.

NOTE

If the GNX 480 is not communicating with the GTX transponder, all of the editable fields for the setup items shown in the following sections will be dashed out.

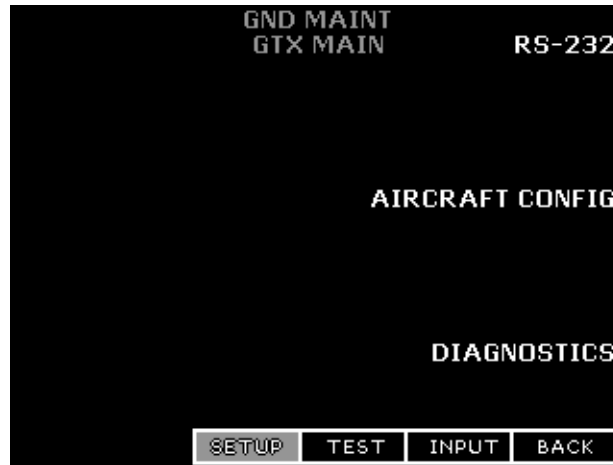

GTX Main Setup Page for GTX 32/327

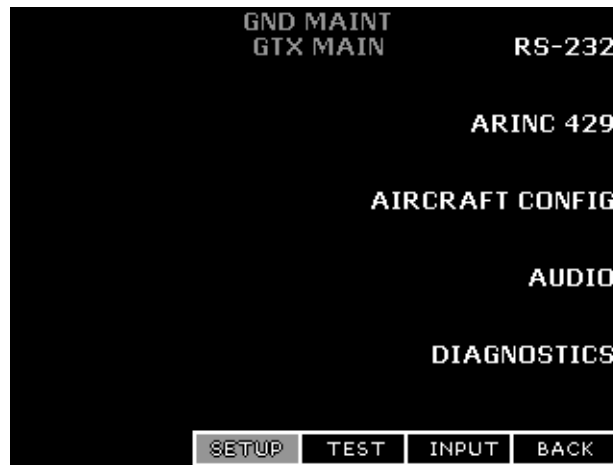

GTX Main Setup Page for GTX 33/330

Figure 3-12 - GTX Main Setup Page

3.2.1.8.1 RS-232

While on the GTX Main Setup menu page, press the RS-232 line select key to configure the GTX transponder serial port settings. The GTX serial port setup page is shown in Figure 3-13.

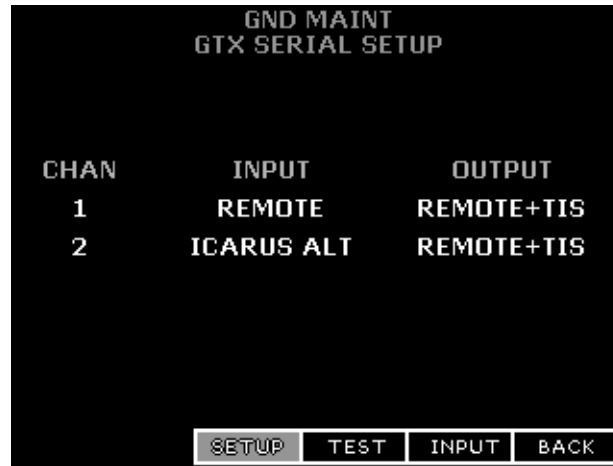

Figure 3-13 – GTX RS-232 Serial Setup Page

Push the small, inner knob in to enter the editing mode. Use the large, outer knob to select the next or previous editable data field and turn the small, inner knob to change the current setting. Set each serial port according to the installation, and leave unused ports set to NONE. Either press the small, inner knob again or press the **MENU/ENTER** key to save the settings. Press the **BACK** smart key to return to the GTX Main Setup menu. The configuration options for the serial input ports and output ports are shown in Table 3-3.

Table 3-3 – GTX RS-232 Serial Port Settings

CHAN	Available Input Settings	Available Output Settings
1	REMOTE	REMOTE or REMOTE+TIS [1]
2	OFF / GPS / ICARUS ALT / ICARUS ALT 25FT / ADC NO ALT / ADC W/ALT / SHADIN NO ALT / SHADIN ALT 25 FT / FADC NO ALT / FADC W/ALT / REMOTE	OFF / ICARUS ALT / REMOTE / REMOTE+TIS

Notes:

- [1] Only one output setting will be available. The setting that is displayed cannot be changed and depends upon the configuration set up on RS-232 serial port 6.

3.2.1.8.2 ARINC 429 (GTX 33/330 Only)

While on the GTX Main Setup menu page, press the ARINC 429 line select key to configure the GTX transponder ARINC 429 port settings. The GTX ARINC 429 port setup page is shown in Figure 3-14.

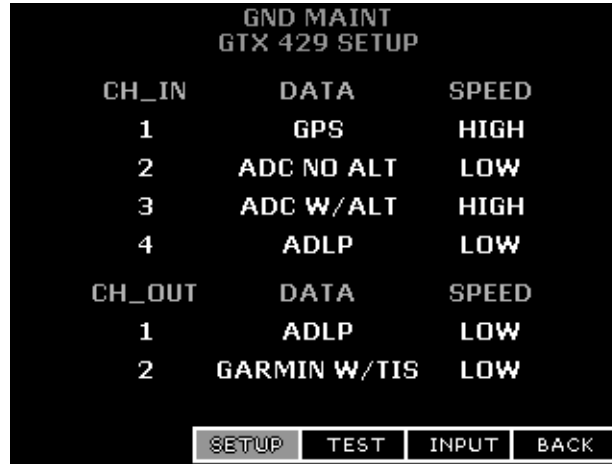

Figure 3-14 – GTX ARINC 429 Setup Page (GTX 33/330 Only)

Push the small, inner knob in to enter the editing mode. Use the large, outer knob to select the next or previous editable data field and turn the small, inner knob to change the current setting. Set each serial port according to the installation, and leave unused ports set to NONE. Either press the small, inner knob again or press the **MENU/ENTER** key to save the settings. Press the **BACK** smart key to return to the GTX Main Setup menu. The configuration options for the serial input ports and output ports are shown in Table 3-4.

Table 3-4 – GTX ARINC 429 Input and Output Port Settings

Channel	Data Settings Available	Speed
CH_IN_1	OFF / GPS / ADC NO ALT / ADC W/ALT / EF/AD NO ALT / EF/AD W/ALT	High / Low
CH_IN_2	OFF / GPS / ADC NO ALT / ADC W/ALT / EF/AD NO ALT / EF/AD W/ALT	High / Low
CH_IN_3	OFF / GPS / ADC NO ALT / ADC W/ALT / EF/AD NO ALT / EF/AD W/ALT	High / Low
CH_IN_4	OFF / ADLP	High / Low
CH_OUT_1	OFF / GARMIN / GARMIN W/TIS / ADLP	High / Low
CH_OUT_2	OFF / GARMIN / GARMIN W/TIS	High / Low

3.2.1.8.3 Aircraft Config

While on the GTX Main Setup menu page, press the **AIRCRAFT CONFIG** line select key to configure the GTX transponder aircraft configuration settings. If a GTX 33 is configured, the **NEXT** softkey will be displayed and a second configuration page will be available. The GTX Aircraft Config setup pages are shown in Figure 3-15.

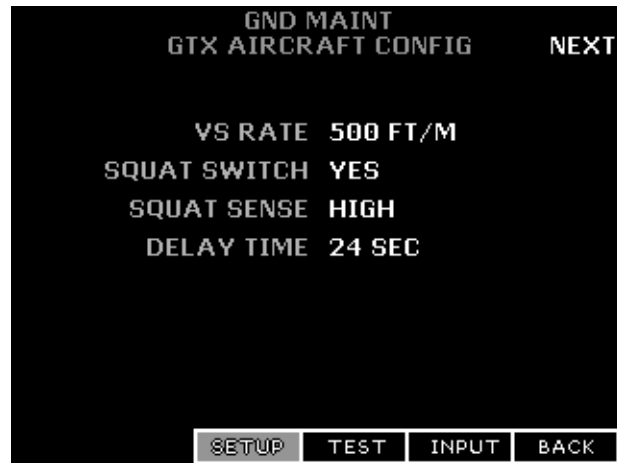

GTX Aircraft Configuration Setup Page – Main Page



GTX Aircraft Configuration Setup Page – Second Page (GTX 33/330 only)

Figure 3-15 – GTX Aircraft Configuration Setup Page

Push the small, inner knob in to enter the editing mode. Use the large, outer knob to select the next or previous editable data field and turn the small, inner knob to change the current setting. Set each configuration item according to the installation, and leave unused ports set to NONE. If a GTX33 is configured, press the **NEXT** line select key to access additional configuration items. Either press the small, inner knob again or press the **MENU/ENTER** key to save the settings. Press the **BACK** smart key to return to the GTX Main Setup menu. The configuration options for the aircraft configuration items are listed below:

VS RATE (Vertical Speed Rate)

This field is the typical vertical speed for climb/descent of the aircraft. The settable number determines the rate of climb the GTX 33/330 assumes as liftoff for operational functions. The range is 100 feet per minute to 9999 feet per minute, and is set to 500 fpm at the factory.

SQUAT SWITCH

The squat switch field may be set to either YES or NO. Selecting YES in this field sets the GTX 33/330 to use the squat switch to determine lift off. Selecting NO sets the GTX 33/330 to use Automated Airborne Determination from other sources.

NOTE

It is important that installations without a squat switch input to the GTX 33/330 be configured with **NO** in the *SQUAT SWITCH* field. Otherwise, the GTX 33/330 can incorrectly report the air/ground state over the Mode S data link.

SQUAT SENSE

The squat sense field may be set to either HIGH or LOW. If the squat switch field is set to YES, the squat sense field is used to define the state of the squat switch input which is recognized as being on the ground (weight-on-wheels).

DELAY TIME

This is the number of seconds the aircraft must be on the ground before the AUTO STANDBY feature automatically switches to standby mode when the airborne source is the squat switch. It has a range of 0 (zero) seconds to 99 seconds, with the default set to 24 seconds.

MODE S ADDRESS (GTX 33/330 ONLY)

NOTE

It is VERY important to enter the Mode S address correctly in the GTX 33/330.

There are two ways to enter the Mode S address into the GTX 33/330, as shown below:

SELECTION	DESCRIPTION
US TAIL #	N-Registration Number
HEX	Hexadecimal code address

For US-registered aircraft, select US TAIL # and then enter the aircraft tail number in the adjacent field. Optionally, select HEX and enter the hexadecimal address directly.

FLIGHT ID (GTX 33/330 ONLY)

There are three ways to enter the Flight ID into the GTX 33/330, as shown below:

SELECTION	DESCRIPTION
SAME AS TAIL	If address is a US registration number, FLT ID can be the same.
POWER UP ENTRY	Enter FLT ID every time the unit is turned on in normal mode.
CONFIG ENTRY	Enter FLT ID in configuration mode only.

AIRCRAFT TYPE (GTX 33/330 ONLY)

The aircraft type is transmitted by the Mode S transponder. Set the AC TYPE to rotor, to a weight of less than 15,500 pounds, more than or equal to 15,500 pounds, or unknown, depending upon the type of aircraft. The default value is ‘less than 15,500 pounds’.

SELECTION	DESCRIPTION
AC TYPE	UNKNOWN, <15.5K LB, >=15.5K LB, or ROTOR.

AIRSPEED (GTX 33/330 ONLY)

The maximum airspeed is transmitted by the Mode S transponder. Set the AIRSPEED field to a speed of less than or equal to 75 knots, between 75 knots and 150 knots, between 150 knots and 300 knots, more than 300 knots, or unknown airspeed, depending on the type of aircraft. Defaults to less than or equal to 150 knots. Enter the aircraft’s maximum cruising true airspeed capability.

SELECTION	DESCRIPTION
MAX AIRSPEED	UNKNOWN, <=75 KT, <=150 KT, <=300 KT, or >300 KT.

3.2.1.8.4 Audio (GTX 33/330 Only)

While on the GTX Main Setup menu page, press the **AUDIO** line select key to configure the GTX transponder audio settings. The GTX Audio setup page is shown in Figure 3-16.

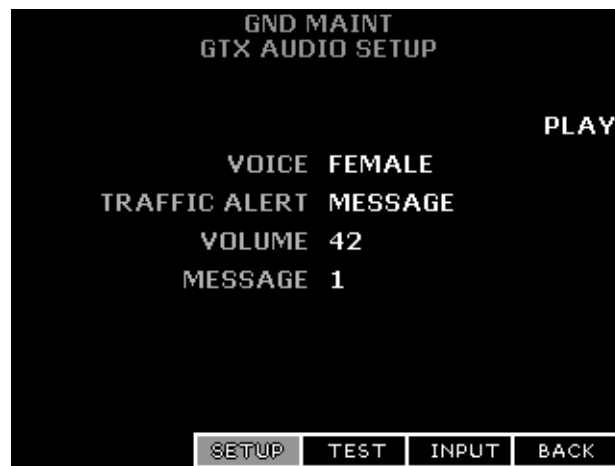

Figure 3-16 – GTX Audio Setup Page (GTX 33/330 Only)

Push the small, inner knob in to enter the editing mode. Use the large, outer knob to select the next or previous editable data field and turn the small, inner knob to change the current setting. Set up the audio warnings using the parameters described below. Either press the small, inner knob again or press the **MENU/ENTER** key to save the settings. Press the **BACK** smart key to return to the GTX Main Setup menu.

VOICE

Select desired VOICE (male or female) that will be used for aural message annunciations.

TRAFFIC ALERT

Sets the Traffic Alert to either Tone or Message. Traffic Information Service (TIS) provides notification of close proximity traffic using the selected alert method.

VOLUME

Sets the output volume level of the GTX 33/330. Make sure the volume level is sufficient for the aircraft environment involved.

MESSAGE

Message is used as a test function only. Message **0** is a continuous tone. Message **1** is a short tone and **2** through **5** are voice messages. Highlight each selection and then press the **PLAY** softkey to listen to the selected message.

NOTE

The continuous tone (Message 0) must be stopped by pressing the **PLAY** softkey while the tone is playing. None of the other messages will be available while the continuous tone is playing.

SELECTION	DESCRIPTION
VOICE (MALE/FEMALE)	Sets the voice to Male or Female. <i>(default is 'male' voice)</i>
TRAFFIC ALERT (TONE/MESSAGE)	Sets the alert type to Tone or Message. <i>(default is 'Tone')</i>
VOLUME (0-63)	Volume is adjusted from 0 (minimum) to 63 (maximum). <i>(default is '0')</i>
MESSAGE (0-5)	Selected audio tones and messages: 0 = Toggles a continuous tone on and off. 1 = Attention Tone, precedes voice messages to attract the pilot's attention. 2 = "Leaving Altitude," (this aural message not used in installations with the GNS 480). 3 = "Traffic," when a TIS traffic alert is received (similar to a "Traffic Advisory" in TCAS terms). 4 = "Timer Expired," when the countdown timer expires (this aural message not used in installations with the GNS 480). 5 = "Traffic Not Available," when TIS service is not available or out of range of an operating TIS Mode S site.

3.2.1.8.5 Diagnostics

While on the GTX Main Setup menu page, press the **DIAGNOSTICS** line select key to display limited information to aid in troubleshooting the transponder. The GTX Diagnostics setup page is shown in Figure 3-17.

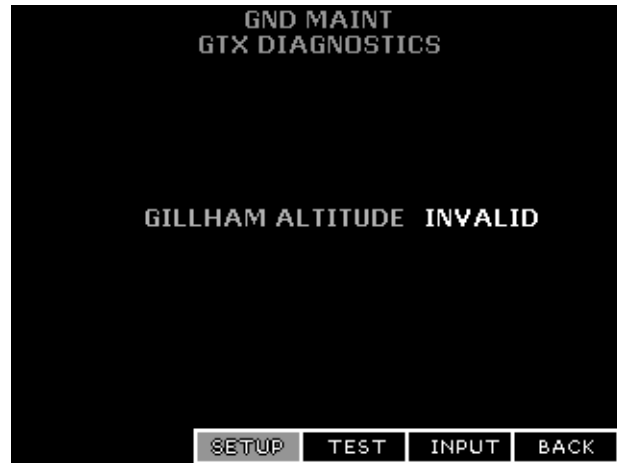

Figure 3-17 – GTX Diagnostics Page

GILLHAM ALTITUDE

If Gillham altitude is provided to the GTX transponder, this field will display the value of the Gillham altitude that the transponder is reading. If Gillham altitude is not being provided to the transponder, INVALID will be displayed.

NOTE

The GTX 32/327 transponder does not currently support this function, so INVALID will always be displayed, even if the transponder is receiving valid Gillham altitude.

3.3 EQUIPMENT OPERATIONAL/FUNCTIONAL TEST

Following equipment configuration, use the GNS 480 Test Function (3.3.1.1) and Interface Monitor Function (3.3.1.2) as necessary to verify that the interfaces are wired correctly. Once the wiring is verified, perform the System Checkout (3.3.2).

3.3.1 GNS 480 CHECKOUT UTILITIES

3.3.1.1 Test Function

The Test function allows the checkout of the display, controls, and I/O of the GNS 480. While in the Ground Maintenance mode, press the **TEST** smart key to enter the Test menu, which is shown in the top part of Figure 3-18. Additional items on the TEST menu (shown in the bottom part of Figure 3-18) are available by pressing the **NEXT PAGE** line select key.



main page



second page

Figure 3-18 - TEST Main Pages

3.3.1.1.1 Flag Test

The FLAG TEST page allows testing of the TO/FROM, CDI Valid, and VDI Valid flags for both the Main and Auxiliary CDI outputs. The Nav Superflag, GSI Superflag, and Localizer (ILS Energize) can also be tested for the Main CDI. While on the TEST menu page, press the **FLAGS** line select key to display the FLAG test page. Press the **SELECT** line select key to toggle between MAIN and AUX CDI flag tests, as shown in Figure 3-19 and Figure 3-20, respectively.

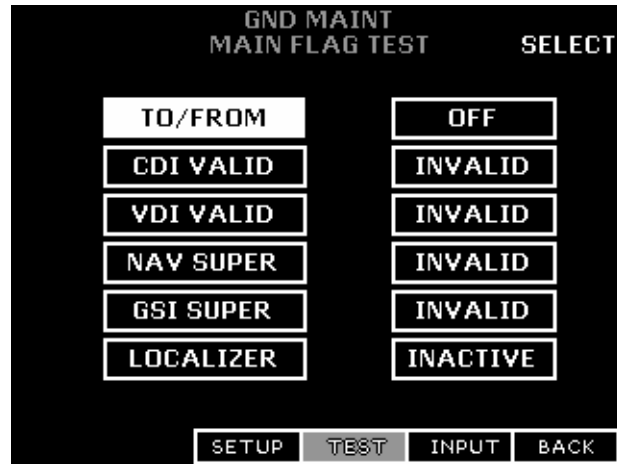

Figure 3-19 - Main CDI Flag Test

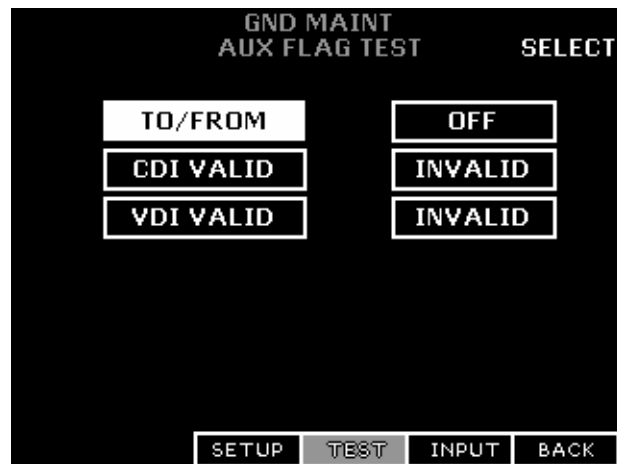

Figure 3-20 – Auxiliary CDI Flag Test

When on the appropriate page turn the large, outer knob to select the flag to be tested. Then turn the small, inner knob to change the setting of that flag. Test each setting for every flag of each CDI connected to the GNS 480.

Press the **TEST** or **BACK** smart key to return to the Ground Maintenance Test menu.

3.3.1.1.2 CDI Deviation Test

The CDI TEST page allows testing of the CDI deviation outputs for both the Main and Auxiliary CDI outputs. While on the TEST menu page, press the **CDI TEST** line select key to display the CDI TEST Page. Press the **SELECT** line select key to toggle between MAIN and AUX CDI deviation tests. The MAIN CDI test screen is shown in Figure 3-21, and the AUX CDI test screen is identical.

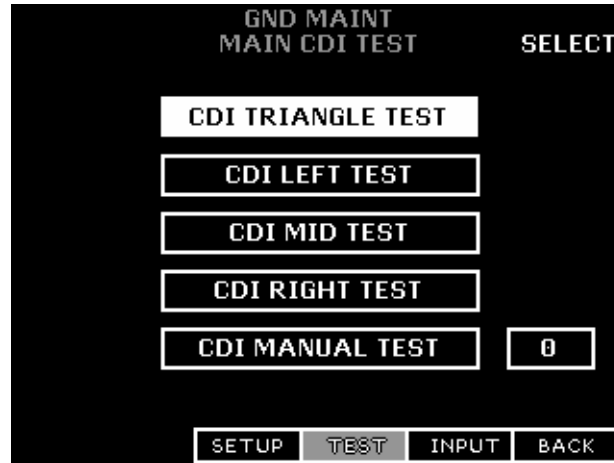

Figure 3-21 – Main CDI Test Page

When on the appropriate page turn the large, outer knob to select the desired CDI deviation test. The test is initiated as soon as it is selected. There are five CDI tests in the following order:

- CDI TRIANGLE TEST: gradually drives the CDI needle left and then right.
- CDI LEFT TEST: drives the external CDI needle full scale left (i.e. output set to 150 mV left).
- CDI MID TEST: drives the external CDI needle to the center (i.e. output set to 0mV).
- CDI RIGHT TEST: drives the external CDI needle full scale right (i.e. output set to 150 mV right).
- CDI MANUAL TEST: allows manual input of CDI outputs (from 10L to 10R in 15 mV steps, with 10 corresponding to a full scale output of 150 mV, and 0 corresponding to center).

As a minimum, perform the LEFT, MID and RIGHT tests for the lateral deviation needle of each CDI connected to the GNS 480.

Press the **TEST** or **BACK** smart key to return to the Ground Maintenance Test menu.

3.3.1.1.3 VDI Test

The VDI TEST page allows testing of the VDI deviation outputs for both the Main and Auxiliary CDI outputs. While on the TEST menu page, press the **VDI TEST** line select key to display the VDI TEST Page. Press the **SELECT** line select key to toggle between MAIN and AUX VDI deviation tests. The AUX VDI test screen is shown in Figure 3-22, and the MAIN VDI test screen is identical.

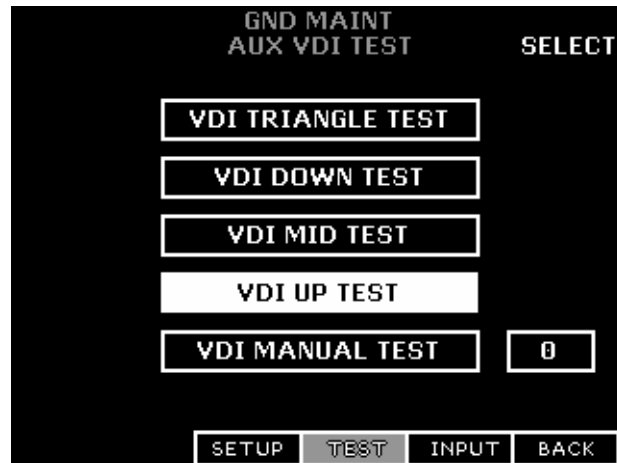

Figure 3-22 – Auxiliary VDI Test Page

When on the appropriate page turn the large, outer knob to select the desired VDI deviation test. The test is initiated as soon as it is selected. There are five VDI tests in the following order:

- VDI Triangle Test: gradually drives the VDI needle up and then down
- VDI Down Test: drives the external VDI needle full scale down (i.e. output set to 150mV down)
- VDI Mid Test: drives the external VDI needle to center (i.e. output set to 0mV)
- VDI Up Test: drives the external VDI needle full scale up (i.e. output set to 150mV up)
- VDI Manual Test: allows manual input of VDI outputs (from 10D to 10U in 15mV steps, with 10 corresponding to a full scale output of 150mV, and 0 corresponding to the center)

As a minimum, perform the DOWN, MID and UP tests for the vertical deviation needle of each CDI connected to the GNS 480.

NOTE

For some HSI's the glideslope indicator may not be visible unless it is receiving a valid signal from the localizer (ILS Energize is present). If this is the case, leave these signals set to VALID following completion of the FLAG TEST in order to see the glideslope indicator.

Press the **TEST** or **BACK** smart key to return to the Ground Maintenance Test menu.

3.3.1.1.4 Annunciator Lamp Output Test

The LAMP OUTPUT TEST page allows testing of each of the annunciator outputs. While on the TEST menu page, press the **LAMP OUTPUT TEST** line select key to display the LAMP OUTPUT Page. The LAMP OUTPUT page is shown in Figure 3-23.



Figure 3-23 - Lamp Output Test

Turn the large, outer knob to select the annunciator output to be tested. The currently selected lamp output is indicated with a white box around it. Turn the small, inner knob to change the setting of the selected annunciator lamp output – a green background indicates that the annunciator output is ON (grounded), and a black background indicates that the annunciator output is OFF (open). Details for each annunciator lamp output that can be tested are found in Table 3-5.

Table 3-5 – Lamp Output Test Items

Display Label	Signal Name	Connector - Pin	Notes
MSG	Message Annunciate	P5-64	
PTK	Parallel Track Annnc	P5-62	
SUSP	Suspend Annunciate	P5-63	
APR	Approach Annunciate	P5-61	
LOI	LOI Annunciate	P5-65	
ALT	Altitude Alert Annnc	P5-69	
PAA	Precision Appr	P5-68	
TRM	Term Mode Annnc	P5-67	
WPT	Waypoint Annunciate	P5-66	
BCKCRS	Back Course Out	P7-15	
GPSIND	GPS Indicator Out	P7-17	The GPSIND and NAVIND toggle, so one is always ON
NAVIND	NAV Indicator Out	P7-18	The GPSIND and NAVIND toggle, so one is always ON
DR	Dead Reck Annunciate	P5-60	

For each annunciator that is used, verify proper operation by turning the annunciator ON and OFF.

Press the **TEST** or **BACK** smart key to return to the Ground Maintenance Test menu.

3.3.1.1.5 Display Test

The Display Test function displays various test patterns and can be used to verify the GNS 480 display operation. While on the Ground Maintenance main TEST menu page, press the **NEXT PAGE** line select key, followed by the **DISPLAY** line select key to go to the Display Test page. Turn the outer knob while on any Test Pattern page to display the next Test Pattern Page in the sequence. The order of test pages is Fonts 1, Fonts 2, Fonts 3, Bitmaps, Red, Green, Blue, White, Black, White on Black, and Black on White. The first available display test screen is shown in Figure 3-24.



Figure 3-24 - Display Test Initial Screen

Press the **TEST** or **BACK** smart key to return to the Ground Maintenance Test menu.

3.3.1.1.6 Bezel Key Test

The Bezel Key Test function verifies the operation of the bezel keys and knobs. While on the Ground Maintenance TEST menu page, press the **BEZEL KEYS** line select key to go the Bezel Key Test page. Follow the on-screen directions to press each one of the bezel keys and actuate the knobs. After completing the bezel key test the results will be shown on the display. If a key / knob is not actuated for ten seconds (30 seconds for the first key in the test sequence), the test will automatically advance to the next key / knob and will show a FAIL message upon completion of the test. Repeat the test carefully to ensure that the keys and knobs are actuated within the required time.

NOTE

Once the Bezel Key Test is initiated it cannot be exited until every key and knob is actuated or times out.



Figure 3-25 - Bezel Key Test

The bezel key test should be run upon initial installation or any time a problem is suspected with one of the GNS 480 bezel keys or knobs.

3.3.1.1.7 Autopilot Test

The AUTOPILOT TEST page allows testing of the roll steering interface (if installed) to the autopilot by allowing specific roll steering commands to be set. While on the TEST menu page, press the **AUTOPILOT TEST** line select key to display the AUTOPILOT TEST page. The AUTOPILOT TEST page is shown in Figure 3-26.



Figure 3-26 - Autopilot Test

Turn the large, outer knob to select the parameter to be edited. The currently selected parameter is shown with a white background. Turn the small, inner knob to change the value of the selected parameter. The roll steering parameter can be set from 30° left to 30° right in one-degree increments. The ground speed can be set from 0 kts to 1000 kts in five-knot increments.

NOTE

Some autopilots or roll-steering converters require ground speed, while others do not. Because of this the capability to set the ground speed using the small, inner knob has also been provided, although it will not be required for all autopilots.

For installations with roll steering, engage the autopilot in GPSS mode and verify that GPSS is valid via the autopilot indication. Vary the roll/steer value left and right and verify that the autopilot behaves accordingly.

Press the **TEST** or **BACK** smart key to return to the Ground Maintenance Test menu.

3.3.1.2 Input Monitor Function

The Input Monitor Function monitors the external inputs to the GNS 480 and displays the data currently being received. Press the **INPUT** smart key in the Ground Maintenance mode to reach the Interface Monitor Function, as shown in Figure 3-27. The display will show the status of the connected interfaces.

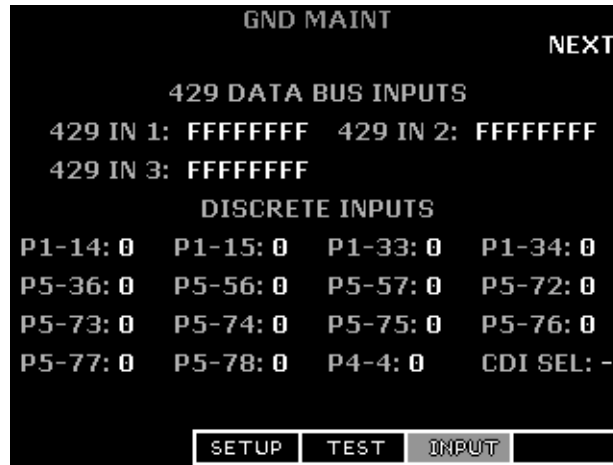

Figure 3-27 - Interface Monitor Function Display - Page 1

This page displays activity on each of the ARINC 429 inputs, and the state of each of the discrete inputs.

Press the **NEXT** line select key to show the next page, which is shown in Figure 3-28.

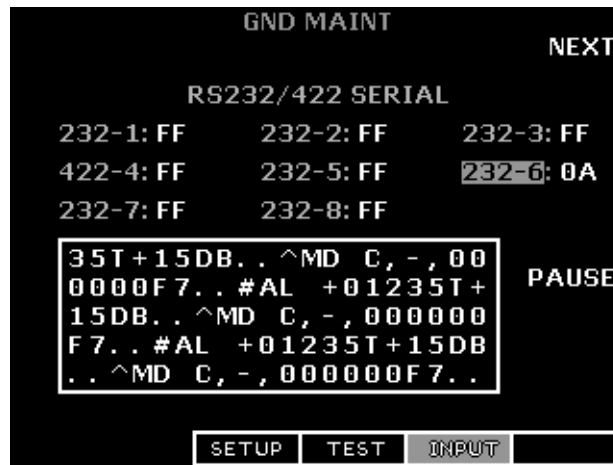

Figure 3-28 - Interface Monitor Function Display - Page 2

This page displays activity on each of the serial inputs, and allows the serial data that is being received on a particular input to be monitored. Turn the large, outer knob to select the input to be monitored. The currently selected serial channel is indicated with a green background. The window on the lower half of the screen displays the last 100 characters that have been received. To stop the update of the data in the window press the **PAUSE** line select key, which will then become the **RUN** line select key. To start the update of the data press the **RUN** line select key.

Press the **NEXT** line select key to show the next page, which is shown in Figure 3-29.

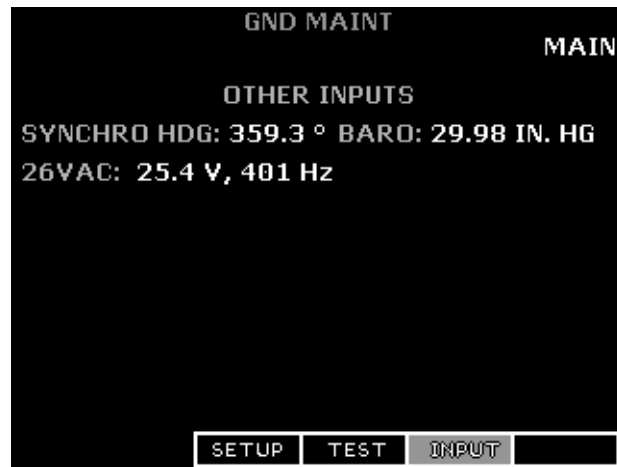

Figure 3-29 - Interface Monitor Function Display - Page 3

This page displays the current values of the synchro heading, baro potentiometer and 26VAC reference inputs.

Press the **MAIN** line select key to return to the Interface Monitor Function Display - Page 1.

Details for each of the inputs that can be monitored are shown in Table 3-6.

For each GNS 480 ARINC 429 input that is used, verify that data is being received. If no data is being received, ensure that (i) the source equipment is turned on, (ii) the ARINC 429 input type and speed has been set up correctly, and (iii) the wiring is correct.

For each discrete input that is connected to the GNS 480, exercise the discrete and verify that the appropriate discrete changes from a '0' to a '1' when activated (the CDI Select input will momentarily change to a 'T' when exercised).

For each GNS 480 serial input that is used, verify that data is being received. If no data is being received, ensure that (i) the source equipment is turned on, (ii) the serial port input RX type has been set up correctly, and (iii) the wiring is correct.

If synchro heading is supplied to the GNS 480, verify that the synchro heading is displayed and agrees with the value provided by the heading source. If the synchro heading is dashed out, ensure that (i) the source equipment is turned on, (ii) the heading valid discrete is VALID (P5-57 = '1'), (iii) the 26VAC 400 Hz reference is being supplied, and (iv) the wiring is correct.

If a baro pot is connected to the GNS 480, verify that the baro-correction is displayed and agrees with the altimeter baro-correction. If the baro-correction value does not vary with the altimeter value, ensure that (i) the baro-correction has been properly calibrated, and (ii) the wiring is correct.

Table 3-6 – Description of Input Monitor Items

Display Label (cyan)	Signal Name	Connector – Pin(s)	Expected Display (white)
429 IN 1: 429 IN 2: 429 IN 3:	ARINC 429 IN 1 ARINC 429 IN 2 ARINC 429 IN 3	P5-7,27 P5-8,28 P5-9,29	'FFFFFFF' will be displayed if no data has been received. The hex value of the most recently received label will be displayed if data is being received. '00000000' will be displayed if data was received, but no data has been received in the last 5 seconds.
P1-14:	Com Flip Flop In	P1-14	'0' in input is open '1' if input is grounded
P1-15:	UP Discrete In	P1-15	'0' in input is open '1' if input is grounded
P1-33:	DOWN Discrete In	P1-33	'0' in input is open '1' if input is grounded
P1-34:	VOR Flip Flop In	P1-34	'0' in input is open '1' if input is grounded
P5-36:	OBI Select In	P5-36	'0' in input is open '1' if input is grounded
P5-56:	RESERVED	P5-56	'0' in input is open '1' if input is > 9 VDC
P5-57:	Heading Valid In	P5-57	'0' in input is open '1' if input is > 9 VDC
P5-72:	RESERVED	P5-72	'0' in input is open '1' if input is grounded
P5-73:	RESERVED	P5-73	'0' in input is open '1' if input is grounded
P5-74:	RESERVED	P5-74	'0' in input is open '1' if input is grounded
P5-75:	RESERVED	P5-75	'0' in input is open '1' if input is grounded
P5-76:	Suspend In	P5-76	'0' in input is open '1' if input is grounded
P5-77:	Audio Inhibit In	P5-77	'0' in input is open '1' if input is grounded
P5-78:	RESERVED	P5-78	'0' in input is open '1' if input is grounded
P4-4:	Com PTT	P4-4	'0' in input is open '1' if input is grounded
CDI SEL:	Main CDI Select In	P7-8	Normally a '-' is displayed. When the input is actuated a 'T' will be displayed for approximately 1 sec.
232-1: 232-2: 232-3: 422-4: 232-5: 232-6: 232-7: 232-8:	RS232 Port 1 In RS232 Port 2 In RS232 Port 3 In RS422 Port 4 In RS232 Port 5 In RS232 Port 6 In RS232 Port 7 In RS232 Port 8 In	P1-4,23 P1-3,21 P1-7,25 P1-11,26 P5-1,41 P5-2,42 P5-10,44 P5-30,44	'FF' will be displayed if no data has been received. The hex value of the most recently received data will be displayed if data is being received. '00' will be displayed if data was received, but no data has been received in the last 5 seconds.
SYNCHRO HDG:	Synchro Heading	P5-18,19,38	If the synchro valid discrete is INVALID or the 26VAC, 400Hz reference is not present, '---' will be displayed; otherwise, the angle of the synchro heading input will be displayed.
BARO:	Baro Correction Pot	P5-13,33,53	The value of the baro potentiometer input will be displayed. '0' will be displayed if input is open, or if the baro pot input has not been properly calibrated.
26VAC	26 VAC Reference	P5-20,39	The voltage and frequency of the 26VAC, 400Hz input will be displayed. If this input is not connected, or if the voltage is below 1VAC, '---' will be displayed.

3.3.2 SYSTEM CHECKOUT – GROUND CHECKS

The GNS 480 includes a self test that is executed every time the unit is turned on that checks the unit operation as well as other internal functions. Verify that the unit does not display a failure indication when turned on.

NOTE

The GNS 480 must be properly configured prior to performing system checkouts. When configured correctly, the GNS 480 will annunciate failures that are detected with interfacing systems when it is first turned on. Any annunciated failures should be corrected prior to proceeding with the ground checks.

3.3.2.1 GPS Navigation Checkout

Switch on the GNS 480 in the normal mode to complete this part of the checkout – this is accomplished by either exiting the Ground Maintenance Mode or by turning the GNS 480 OFF and then turning it back ON.

The GNS 480 requires a “seed” position, time, and date for the GPS sensor to know which satellites to look for. Once this information is entered it will be saved and updated automatically, so it will not be necessary to re-enter the information at every start-up. If the GNS 480 is moved a great distance without being turned on, the seed position may have to be re-entered.

NOTE

This checkout must be completed with the aircraft moved away from hangars and other structures that may obstruct the view of the satellites.

3.3.2.1.1 Initial Power-Up

The first time the GNS 480 is used after it is installed, the GPS seed position, UTC time and date must be entered. Following the display of the main start-up screen, the screen shown in Figure 3-30 will be displayed for 10 seconds. Press the **CHG** smart key to allow the position to be edited. The latitude (degrees) will be highlighted. Use the large, outer knob to select the next or previous editable data field and turn the small, inner knob to change the current setting. When the position, UTC time and date have been entered, press the **MENU/ENTER** key to accept the entries. The Master GPS Reset must be set to ‘No’.

NOTE

The latitude and longitude must be within one degree of the actual position, and the UTC time (not local time) must be within one minute. If position, time and date are not entered correctly, GPS acquisition may take up to 20 minutes.

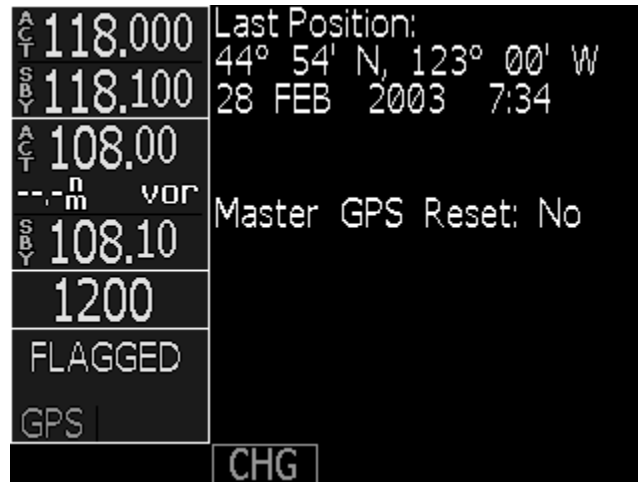

Figure 3-30 – GPS Information Start-up Screen

If the exact position is not known, the GNS 480 can determine its own initial position. If it is desired to let the GNS 480 determine its own position, do not enter the position, time and date after the **CHG** smart key is pressed. Instead, use the use the large, outer knob to select the Master GPS Reset item and set it to ‘Yes’ using the small, inner knob. Press the **MENU/ENTER** key to accept the changes, and then press the **MENU/ENTER** key again to acknowledge the STOP! message.

NOTE
GPS acquisition may take up to 20 minutes after a Master GPS Reset is performed.

3.3.2.1.2 GPS Operation and Position

Check the GPS operation as follows:

1. Turn on the GNS 480 and allow the unit to acquire a position. All other avionics should be turned off for this part of the test.
2. Check the position using the GPS Status page, which is shown in Figure 3-31. This page is accessed by pressing the **FN** key twice, causing the **SYS** smart key to be displayed. The **SYS** smart key is then pressed, followed by the **GPS** smart key, if necessary. The lat/long displayed on this page should agree with a known reference position.

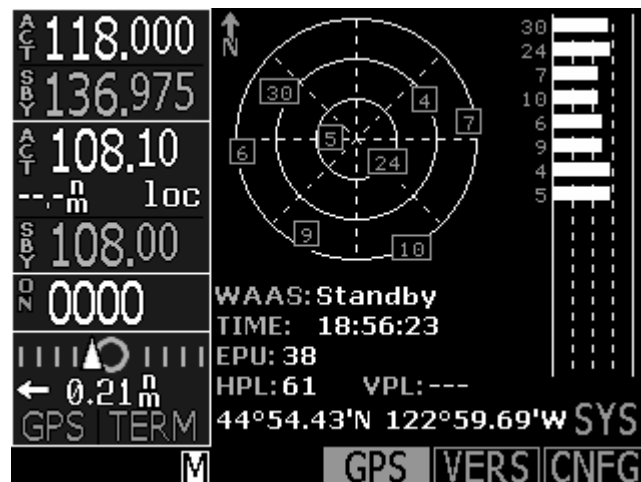

Figure 3-31 – GPS Status Page

3. Check the GPS signal reception using the GPS Status page. Typical signal levels are between 60% and 80% of full scale (viewed using the bar graph), although values above and below this range are normal.
4. Turn on other avionics one at a time and check the GPS signal reception to make sure it is not affected.
5. Check for VHF com transmitter interference.

NOTE
The interference check must be completed on all IFR installations.

- a) Verify that at least five satellites are displayed in green boxes (with the corresponding satellite vehicle number displayed in green on the left of the bar graph). Ensure that NO POSITION FIX is not displayed.
- b) Press the **COM** bezel key and tune the GNS 480 Com to 121.125 MHz. Listen on the frequency to ensure it is not in use, and then transmit for 30 seconds.

NOTE
When the mic has been keyed for 35 seconds, a “WARNING Stuck Microphone” message will pop-up and the com transmitter will stop transmitting. If required to transmit for an additional 15 seconds, the PTT switch must be momentarily released and then re-keyed to continue transmitting – the WARNING message does not have to be cleared to continue transmitting.

- c) While transmitting, observe the signal status of each satellite being received. If the satellite signals are significantly degraded or some satellite signals are lost during the test, continue transmitting for another 15 seconds. Verify that the GPS position remains valid (if position is lost, NO POSITION FIX will be displayed in place of the position data). If position is lost, additional isolation measures will have to be taken.
- d) If required, clear the “WARNING Stuck Microphone” message by pressing the **CLR** bezel key. Repeat steps b) and c) for additional frequencies as follows.

121.150 MHz	131.225 MHz
121.175 MHz	131.250 MHz
121.185 MHz [1]	131.275 MHz
121.190 MHz [1]	130.285 MHz [1]
121.200 MHz	131.290 MHz [1]
121.225 MHz	131.300 MHz
121.250 MHz	131.325 MHz
131.200 MHz	131.350 MHz

[1] frequency is only applicable to VHF radios with 8.33 kHz channel spacing

- e) Repeat for each com transmitter installed in the aircraft.
- f) If aircraft is TCAS-equipped, turn on the TCAS system and verify that GPS position remains valid (if position is lost, NO POSITION FIX is displayed in place of the position data).
- g) If aircraft is SATCOM-equipped, use the SATCOM system and verify that GPS position remains valid (if position is lost, NO POSITION FIX is displayed in place of the position data).
- h) If the GNS 480 is susceptible to VHF Com transmitter interference, then better isolation (or greater separation) may be required between the GPS and VHF (or other offending system) antennas. With some com transmitters, a 1575.42 MHz notch filter (such as Garmin AT P/N 162-

1059) may be required in series with the VHF Com antenna coax at the rear of the com unit. ELT's may re-radiate harmonics of the VHF Com signal into the GPS band. A 1575.42 MHz notch filter on the ELT will solve this.

NOTE

Older VHF Com transmitters may emit higher levels of harmonic interference causing greater problems and may be more difficult to deal with.

3.3.2.2 VHF Nav Checkout

Press the **CDI** bezel key to select VOR CDI mode (indicated by a green VOR in the left portion of the GNS 480 CDI display). To the right of the VOR indication is the current setting of the OBS. Verify that the OBS decodes properly from 0 to 360 degrees (the value displayed on the GNS 480 should be within $\pm 2^\circ$ of the OBS). Check the operation of remote VOR flip-flop switch (if installed).

Check the VOR reception with ground equipment, operating VOT or VOR, and verify audio and Morse code ID functions (if possible). Tune a Localizer frequency and verify the CDI needle and NAV flag, and VDI needle and GS flag operation.

NOTE

Some VOR test equipment may not be compatible with the digital signal processing of the VHF Nav receiver and will give erroneous results. Examples of equipment known to function properly are: IFR Nav 750 and Collins 479S-6.

3.3.2.3 VHF Com Checkout

3.3.2.3.1 Antenna Check

If desired, the antenna VSWR can be checked using an inline wattmeter in the antenna coax using frequencies near both ends of the band. The VSWR should be $< 2:1$, and is not to exceed $3:1$. A VSWR of $2:1$ will cause a drop in output power of approximately 12%, and $3:1$ causes approximately a 26% drop.

3.3.2.3.2 Receiver / Transmitter Operation

Press the **COM** bezel key to allow control of the VHF com transceiver. Tune the unit to a local frequency and verify the receiver output produces a clear and understandable audio output. Verify the transmitter functions properly by contacting another station and getting a report of reliable communications. Check the operation of remote com flip/flop switch (if installed). If necessary, adjust the RF Squelch and Mic Gain values as describe in 3.2.1.5.

3.3.2.3.3 Sidetone Level Adjustment

The sidetone volume was preset at the factory to a typical audio level. The level can be adjusted as follows:

1. Press the **COM** bezel key to allow control of the VHF com transceiver.
2. Press the **MENU/ENTER** key to display the com menu, and press the **AUDIO** line select key to display the volume adjustment window.
3. Rotate the large, outer knob to select the **Sidetone** item.
4. Rotate the **PWR/VOL** knob or the small, inner knob to adjust the sidetone level. The sidetone level is displayed as a horizontal bar, showing the level from zero to 100%. The sidetone level can be adjusted during transmit.
5. Press the **MENU/ENTER** key when done.

3.3.2.4 Interface Checkout

This section describes checks that can be carried out to verify that systems interfacing to the GNS 480 are communicating properly.

3.3.2.4.1 GNS 480 Message Audio

The GNS 480 can announce audio messages through an audio panel. This check verifies that the audio connection from the GNS 480 to the audio panel is functional. Prior to proceeding with this check, ensure that the audio panel is set to announce the GNS 480 message audio. If the following steps do not perform correctly, check the electrical connections and AMA volume setting.

1. Go to the System Configuration page. This page is accessed by pressing the **FN** key repeatedly until the **SYS** smart key is displayed. The **SYS** smart key is then pressed, followed by the **CNFG** smart key, if necessary.
2. While on the System Configuration page, rotate the large, outer knob to scroll down to the **Msg Tone** item and verify that it is set to **ON**. If it is set to **OFF**, push the small, inner knob in to edit the setting and rotate the small, inner knob to change the setting to **ON**. Press the **MENU/ENTER** key to accept the setting.
3. Rotate the large, outer knob and scroll up to the **Mag Var** setting. Press the small, inner knob in to edit the setting and rotate the small, inner knob to change the setting to **MANUAL**. As soon as the setting is changed to **MANUAL** the GNS 480 will display a “Using Manual Mag Var” message and play the message tone. Verify that this tone is heard over the audio system.
4. If necessary, adjust the Message Audio volume level as described below and replay the tone to verify the new setting.
5. Return the **Mag Var** setting to **AUTO**.

Message Audio Volume Level Adjustment

The message audio volume was preset at the factory to a typical audio level. The level can be adjusted as follows:

1. Press the **COM** bezel key, followed by the **MENU/ENTER** key to display the com menu. Press the **AUDIO** line select key to display the volume adjustment window. The audio message (**AMA**) selection will be selected. Rotate the **PWR/VOL** knob or the small, inner knob to adjust the audio message volume level. The audio message level is displayed as a horizontal bar, showing the level from zero to 100%.
2. Press the **MENU/ENTER** key when done.

3.3.2.4.2 Baro Correction Potentiometer

The GNS 480 can receive baro correction from an external potentiometer. This check verifies that the GNS 480 is receiving baro correction data from the altimeter. Ensure that the GNS 480 is turned on. If the following steps do not perform correctly, check the electrical connections and configuration setup.

1. Check the baro correction using the Configuration page. This page is accessed by pressing the **FN** key twice, causing the **SYS** smart key to be displayed. The **SYS** smart key is then pressed, followed by the **CNFG** smart key, if necessary. The baro correction is the first item on the list (Baro Correct.).
2. Verify that the baro correction decodes properly from 28.10 to 31.00 "Hg (952 to 1050 mB). The value displayed on the GNS 480 should be within ± 0.03 "Hg (± 1 mB) of the altimeter setting.

3.3.2.4.3 Air Data Computer, Altitude Encoder and Fuel Air/Data Computer

The GNS 480 can receive altitude or fuel/air data from an external source. This check verifies that the GNS 480 is receiving data from these units. Ensure that the GNS 480 and MX20 are turned on and in normal mode. If the following steps do not perform correctly, check the electrical connections and configuration setup.

NOTE

For dual GNS 480 installations, this check must be performed for each GNS 480. While this check is carried out, the other GNS 480 must be turned off.

3. Press the **MAP** bezel key and use the large, outer knob to select MAP 2.
4. Press the **MENU/ENTER** key to display the line select key functions, and repeatedly press the **MORE** line select key until the **NAV DATA** line select key legend is displayed.
5. Press the **NAV DATA** line select key to display nav data in the window on the left.
6. The ALT field will display the baro-corrected altitude. If the ALT field is not displayed, press the **SEL DATA** line select key and use the small, inner knob to select the ALT field for display and press **MENU/ENTER** when the appropriate field is selected. Verify that this altitude value is not dashed out, and that the altitude agrees with the altimeter (± 125 ft).

NOTE

The baro-correction that is set on the altimeter and GNS 480 must be the same in order for the displayed altitude values to agree.

7. If fuel data is being provided to the GNS 480, press the **MENU/ENTER** key to display the line select key functions, and repeatedly press the **MORE** line select key until the **NAV DATA** line select key legend is displayed.

8. Press the **SEL DATA** line select key and use the use the small, inner knob to select the FUEL FLOW field for display and press **MENU/ENTER** when the appropriate field is selected. Verify that this fuel flow value is not dashed out, and that the fuel flow agrees with the corresponding instrument.

3.3.2.4.4 MX20 Display Checkout

The GNS 480 can transmit flight plan data to the MX20 (and baro-correction if the GNS 480 is receiving baro-correction from an altimeter). If the MAPMX interface is used, the MX20 can transmit baro-correction to the GNS 480. This check verifies that the units are communicating. Ensure that the GNS 480 and MX20 are turned on and in normal mode. If the following steps do not perform correctly, check the electrical connections and configuration setup.

NOTE

When connecting a GNS 480 to the MX20 the recommended interface protocol is bi-directional MAPMX, since additional functionality is provided. The MAPMX protocol is only supported in MX20 version 5.0 or later. If it is desired to use a version 4.x or earlier MX20, the interface should be set to MAPCOM (this is a uni-directional interface, and data is only provided from the GNS 480 to the MX20).

MAPCOM Interface (use only for MX20 version 4.x or earlier):

1. Check the System Info page on the MX20 to verify that the data is available to each port and that it is being processed properly.
2. Load a flight plan into the GNS 480 and verify that the flight plan is displayed on the MX20 on the FPL page.

MAPMX Interface (use for MX20 version 5.0 or later):

1. Check the System Info page on the MX20 to verify that the data is available to the MAPMX port and that it is being processed properly.
2. Load a flight plan into the GNS 480 and verify that the flight plan is displayed on the MX20 on the FPL page.

NOTE

If the GNS 480 is configured to receive baro correction from a baro potentiometer the GNS 480 will provide baro-correction data to the MX20. If no external baro correction is supplied to the GNS 480, the MX20 will supply baro correction to the GNS 480.

3. If a the GNS 480 is configured for BARO POT: NOT INSTALLED, verify that the baro-correction on the MX20 and GNS 480 are the same. Change the baro-correction on the MX20 and verify that it changes on the GNS 480. The GNS 480 baro-correction can be viewed on the System Configuration page, which is accessed by pressing the **FN** key repeatedly until the **SYS** smart key is displayed. The **SYS** smart key is then pressed, followed by the **CNFG** smart key, if necessary.

3.3.2.4.5 Dual GNS 480 Cross-Talk Checkout

If two GNS 480's are installed, they will share information with each other. This check verifies that the two GNS 480's are communicating. If the following steps do not perform correctly, check the electrical connections and configuration setup.

NOTE

If the GNS 480 is configured to communicate with the MX20 using the MAPMX interface, turn the MX20 off when performing this checkout.

1. Verify that the message “Communications lost with cross-linked unit” is not currently active on either GNS 480.
2. On GNS 480 #1 and #2, view the baro correction using the Configuration page. This page is accessed by pressing the **FN** key twice, causing the **SYS** smart key to be displayed. The **SYS** smart key is then pressed, followed by the **CNFG** smart key, if necessary. The baro correction is the first item on the list (Baro Correct.).
3. Change the baro correction on GNS 480 #1 and verify that it changes to the same value on GNS 480 #2. Repeat by changing the baro correction on GNS 480 #2 and verifying that it changes to the same value on GNS 480 #1.

NOTE

If one GNS 480 is configured to accept baro correction data from an altimeter, the baro correction on the altimeter must be changed and the new value must appear on both GNS 480's.

3.3.2.4.6 Transponder Checkout

The GNS 480(s) can remotely control the SL70/SL70R, GTX 33/330 and GTX 32/327 transponders. This check verifies that the units are communicating. Ensure that the GNS 480(s) and transponder are turned on and in normal mode. If the following steps do not perform correctly, check the electrical connections and configuration setup.

Single GNS 480 Installation:

1. Verify that the transponder squawk code is displayed in white. Press the **XPDR** bezel key and verify that you are able to change the transponder squawk code on the GNS 480 (turning the large, outer knob will allow you to edit the squawk code using the small, inner knob or line select/smart keys). If an SL70 / GTX 330 / GTX 327 transponder is connected, you should see the squawk code displayed on the front of the transponder change to the value set on the GNS 480.
2. Turn off the transponder or open the transponder circuit breaker and verify that the squawk code on the GNS 480 changes to yellow.
3. Turn on the transponder or close the transponder circuit breaker and verify that the squawk code on the GNS 480 changes back to white.

Dual GNS 480 Installation:

1. Turn on GNS 480 #1 and turn off GNS 480 #2.
2. Verify that the transponder squawk code is displayed in white on GNS 480 #1. Press the **XPDR** bezel key on GNS 480 #1 and verify that you are able to change the transponder squawk code on the GNS 480 (turning the large, outer knob will allow you to edit the squawk code using the small, inner knob or line select/smart keys). If an SL70 / GTX 330 / GTX 327 transponder is connected, you should see the squawk code displayed on the transponder change to the value set on the GNS 480.
3. Turn off the transponder or open the transponder circuit breaker and verify that the squawk code on the GNS 480 changes to yellow.
4. Turn on the transponder or close the transponder circuit breaker and verify that the squawk code on the GNS 480 changes back to white.
5. Turn off GNS 480 #1 and turn on GNS 480 #2.

6. Verify that the transponder squawk code is displayed in white on GNS 480 #2. Press the **XPDR** bezel key on GNS 480 #2 and verify that you are able to change the transponder squawk code on the GNS 480. If an SL70 / GTX 330 / GTX 327 transponder is connected, you should see the squawk code displayed on the transponder change to the value set on the GNS 480.

TIS Traffic Enabled (GTX33+TIS Configured):

1. On the GNS 480 go to the traffic page. This page is accessed by pressing the **FN** key repeatedly until the **TFC** smart key is displayed. The **TFC** smart key is then pressed to display the traffic page.
2. Verify that 'Data Fail' or 'Failed' is not displayed, and the TIS operating mode (STBY or OPER) is displayed in the upper right hand corner.

NOTE

If the TIS mode is OPER, 'TFC N/A' will be displayed in the center of the screen because you do not have TIS coverage. This is normal operation and does NOT indicate a problem with the installation.

3.3.2.4.7 SL30 Nav/Com Checkout

When SL30 Nav tuning is provided to the GNS 480, the GNS 480 will output Distance, Speed, and Time (DST) information via the MapCom output (the GNS 480 also provides Comm/NAV frequency information from its database). This check verifies that the units are communicating. Ensure that the GNS 480 and SL30 are turned on and in normal mode, and that the GNS 480 has a valid position. If the following steps do not perform correctly, check the electrical connections and configuration setup.

1. Operate the SL30 in NAV mode.
2. Press the SL30 **SEL** button to bring up the NAV frequency recall lists.
3. Turn the SL30 large knob clockwise until the nearest VOR list is displayed (the identifier and frequency of the nearest VOR station will be displayed).
4. Press the SL30 flip-flop (↔) button to swap the listed VOR frequency to the active frequency.
5. Press the SL30 **SEL** button and turn the SL30 large knob one click counterclockwise to show the DST display prompt. If you do not see SHOW DST DATA, either the feature is disabled on the SL30 or the SL30 and GNS 480 are not communicating over the serial interface.

3.3.2.4.8 Compass System

The GNS 480 can receive heading from an external source (XYZ synchro, FADC, or ARINC 429 heading source). This check verifies that the GNS 480 is receiving data from the compass system. Ensure that the GNS 480 and compass system are turned on the heading is valid. If the following steps do not perform correctly, check the electrical connections and configuration setup.

1. Press the **MAP** bezel key and use the large, outer knob to select MAP 2.
2. Press the **MENU/ENTER** key to display the line select key functions, and repeatedly press the **MORE** line select key until the **NAV DATA** line select key legend is displayed.
3. Press the **NAV DATA** line select key to display nav data in the window on the left.
4. The HDG field will display the magnetic heading. If the HDG field is not displayed, press the **SEL DATA** line select key and use the small, inner knob to select the HDG field for display and press **MENU/ENTER** when the appropriate field is selected. Verify that this heading value is not dashed out, and that the heading agrees with the HSI ($\pm 2^\circ$).

3.3.2.4.9 Autopilot

The GNS 480 provides GPSS roll steering information to an appropriate autopilot. When connected properly, the autopilot will show a GPSS valid indication when the GNS 480 has a valid GPS position and is navigating to a waypoint.

NOTE

Some autopilots require that groundspeed be above a certain threshold in order for GPSS to be valid. This is accomplished by placing the GNS 480 in Simulator Mode.

This check verifies that the autopilot is receiving data from GNS 480. Ensure that the autopilot is turned on and in normal mode. If the following steps do not perform correctly, check the electrical connections and configuration setup.

1. Apply power to the equipment, and after the GNS 480 splash screen clears press the **SUSP** bezel key on the GNS 480 *three times* to go into Simulator Mode. Press the **MENU/ENTER** key to acknowledge entry into the Simulator Mode. Allow the GNS 480 to complete its normal start-up sequence.
2. In the GNS 480, set a course to a destination waypoint. This can be done by pressing the **NRST** bezel key to display a list of nearby waypoints. Then use the large, outer knob to select a suitable waypoint and press the **DIRECT-TO** bezel key, followed by the **Direct** line select key.
3. Press the **MAP** bezel key and then press the **SPD** smart key to verify the simulated ground speed. Ensure that the ground speed is set to 120 kts (if necessary, the ground speed can be adjusted using the small, inner knob and then pressing the **MENU/ENTER** key to acknowledge the entry).

CAUTION

When the autopilot is engaged, flight control surface movement can occur.

4. Engage the autopilot in GPSS mode. Verify that GPSS is valid via the autopilot annunciation.
5. Press the CDI Select key to select Nav data on the CDI. Verify that the autopilot annunciates GPSS Fail.
6. Exit the Simulator Mode by turning the GNS 480 off and then back on.
7. Verify all other connections between the GNS 480 and the autopilot (e.g. the deviation signals and flags). These signals can be simulated using the Ground Maintenance mode (see section 3.3.1).

3.3.2.4.10 RMI/OBI

The GNS 480 RMI/OBI output can be used to drive an RMI (or OBI) navigation indicator. This check verifies that the RMI/OBI is receiving data from the GNS 480. If the following steps do not perform correctly, check the electrical connections and configuration setup.

1. Apply power to the equipment and wait for the GNS 480 to acquire a position.
2. In the GNS 480, set a course to a destination waypoint. This can be done by pressing the **NRST** bezel key to display a list of nearby waypoints. Then use the large, outer knob to select a suitable waypoint and press the **DIRECT-TO** bezel key, followed by the **Direct** line select key.
3. If an external RMI select switch is installed, set it to the GPS position (if no switch is installed, the GNS 480 output automatically defaults to GPS data).
4. Verify that the RMI needle swings and points towards the GPS waypoint selected

NOTE

The aircraft heading system must be operating properly in order for the RMI needle to point correctly.

5. If installed, set the RMI select switch to the Nav position. Tune a local VOR station, or use a simulated signal from an approved VOR Test System.
6. Verify that the RMI needle swings and points towards the VOR station.

3.3.2.4.11 DME

The GNS 480 can channel a DME based upon the tuned VOR frequency. This check verifies that the GNS 480 is properly tuning the DME. If the following steps do not perform correctly, check the electrical connections and configuration setup.

1. Tune a co-located VOR/DME station. Listen to the DME ident via the audio panel and ID the station to verify that it is correct.
2. Tune an invalid VOR station. Verify that the DME changes to an invalid station.

3.3.2.4.12 Skywatch

The GNS 480 can display traffic from a Skywatch system, and can optionally provide the user interface to control the Skywatch system. This check verifies that the GNS 480 is properly receiving traffic data and (if applicable) controlling the Skywatch operating modes. If the following steps do not perform correctly, check the electrical connections and configuration setup.

1. On the GNS 480 go to the traffic page. This page is accessed by pressing the **FN** key repeatedly until the **TFC** smart key is displayed. The **TFC** smart key is then pressed to display the traffic page.
2. Verify that 'Data Fail' is not displayed and the Skywatch operating mode is displayed in the upper right hand corner.

NOTE

The following steps need to be completed only if the GNX 480 is providing the user interface to the Skywatch. The Skywatch weight-on-wheels switch must indicate 'on ground' in order for the following checks to be completed.

3. Press the **MENU/ENTER** key to display the line select key functions and press the **STBY / OPER** line select key. Verify that pressing the **STBY / OPER** line select key toggles the Skywatch mode between STBY and OPER.
4. Ensure that the Skywatch is in Standby, and press the **TEST** line select key. Verify that 'Self Test in Progress' is displayed and the Skywatch test pattern is displayed on the traffic page.

NOTE

For dual GNS 480 installations, this check must be performed for each GNS 480 that is configured to display traffic. Both GNS 480 units can be on while this check is carried out on each unit.

3.3.2.4.13 CO Guardian

The GNS 480 can receive carbon monoxide level from an external sensor. This check verifies that the GNS 480 is receiving data from these units. Ensure that the GNS 480 and carbon monoxide sensor are turned on and in normal mode. If the following steps do not perform correctly, check the electrical connections and configuration setup.

NOTE

For dual GNS 480 installations, this check must be performed for each GNS 480 that is receiving information from the carbon monoxide sensor.

1. Press the **MAP** bezel key and use the large, outer knob to select MAP 2.
2. Press the **MENU/ENTER** key to display the line select key functions, and repeatedly press the **MORE** line select key until the **NAV DATA** line select key legend is displayed.
3. Press the **NAV DATA** line select key to display nav data in the window on the left.
4. Press the **SEL DATA** line select key and use the small, inner knob to select the CO LVL field for display and press **MENU/ENTER** when the appropriate field is selected. Verify that this carbon monoxide level value is not dashed out, and that the level agrees with the detector.

3.3.3 SYSTEM CHECKOUT – FLIGHT CHECKS

All system functions that cannot be adequately tested on the ground will require a flight test. Even if all functions can be verified on the ground, a flight test is recommended as a final installation verification. Verify system operation as described in the following sections.

3.3.3.1 Com Flight Test Check

1. Verify the com performance by contacting a ground station at a range of at least 50nm while maintaining an appropriate altitude, and over all normal flight attitudes. Performance should be checked using low, high, and mid band frequencies.

3.3.3.2 VOR Flight Test Check

1. Tune a local VOR station within 50 miles.
2. Verify the audio ident/voice quality.
3. Verify the Morse code decoder IDs the station (95% probability).
4. Fly to and from the station.
5. Verify NAV flag, TO/FROM flag, and CDI are operational.
6. Record accuracy in System Log (see manual).

3.3.3.3 ILS Flight Test Check

1. Tune an ILS at the local airport.
2. Verify the audio ident/voice quality.
3. Verify the Morse code decoder IDs the station (95% probability).
4. Fly the approach.
5. Verify NAV flag, GS flag, and CDI and VDI are operational.
6. Verify BC annunciator.

3.3.3.4 GPS Flight Test Check

1. Verify that GPS position is not lost during normal aircraft maneuvering (e.g. bank angles of up to 30 degrees and pitch angles associated with take-off, departures, approaches, landing and missed approaches as applicable). If GPS position is lost, a “WARNING Loss of Navigation” message will be displayed.
2. Enter and activate a flight plan on the GNS 480. Fly the flight plan and verify that the display of flight plan data is consistent with the CDI indication (deviation, TO/FROM...) in the pilot’s primary field of view.

3.3.3.5 Autopilot Flight Test Check

1. Enter and activate a flight plan on the GNS 480. Engage the autopilot in the GPSS mode. Verify that the autopilot flies the course.
2. Disengage the autopilot and fly off course. Re-engage the autopilot (in GPSS mode) and verify that it correctly intercepts the course and continues to fly it.
3. Turn off the autopilot GPSS but leave the autopilot engaged in Nav mode. Verify that it maintains the current course.

3.4 DATABASE CHECK

Check the database to ensure it is current. The database information is displayed at startup. To check the database:

1. Turn off the GNS 480 and then turn it on. The GNS 480 will go through its normal start-up sequence.
2. Wait for the database page to be displayed.
3. Verify that the database is not expired (the expiration date will be displayed in green text if the database is current, and yellow text if it has expired).

If the database card has to be reprogrammed with a new revision, remove and replace the database card as described in the following section.

3.4.1 DATA CARD REPLACEMENT

CAUTION

Handle the data card carefully. Do not touch the connector edge of the data card. Do not insert or remove the data card within 10 seconds after the GNS 480 is turned on.

To replace the data card do the following:

1. Ensure that the GNS 480 is turned off.
2. Press the data card ejector to eject the card and remove the data card. Gently pull the card straight out of the slot.
3. With the label facing left, insert the new data card by pushing the card straight into the slot and press firmly into place. When fully inserted, the ejector button will be flush with the top of the data card.

Table 3-7 - GNS 480 Post-Installation Checkout Log

GNS 480 Post-Installation Checkout Log		Date: ___/___/___ By: _____
GNS 480 CONFIGURATION INFORMATION:	430-6100-8 _____ - _____ Mod _____ Serial # _____	
EXTERNAL CDI/HSI SOURCE SELECTION ANNUNCIATOR: Annunciator: <input type="checkbox"/> Required <input type="checkbox"/> Not Required <input type="checkbox"/> [<input type="checkbox"/> N/A] Annunciator Installed		
SETUP ITEMS:		
Serial Interface Configuration (RX/TX):		ARINC 429 Input Configuration:
_____ / _____	(Port 1)	_____ <input type="checkbox"/> Hi <input type="checkbox"/> Low (Channel 1 In)
_____ / _____	(Port 2)	_____ <input type="checkbox"/> Hi <input type="checkbox"/> Low (Channel 2 In)
_____ / _____	(Port 3)	_____ <input type="checkbox"/> Hi <input type="checkbox"/> Low (Channel 3 In)
_____ / _____	(Port 4)	
_____ / _____	(Port 5)	
_____ / _____	(Port 6)	ARINC 429 Output Configuration:
_____ / N/A	(Port 7)	_____ <input type="checkbox"/> Hi <input type="checkbox"/> Low (Channel 1 Out)
_____ / N/A	(Port 8)	_____ <input type="checkbox"/> Hi <input type="checkbox"/> Low (Channel 2 Out)
Resolver: Resolver: <input type="checkbox"/> Installed <input type="checkbox"/> Not Installed <input type="checkbox"/> [<input type="checkbox"/> N/A] Resolver Calibrated		Baro-Correction: Baro Pot: <input type="checkbox"/> Installed <input type="checkbox"/> Not Installed <input type="checkbox"/> [<input type="checkbox"/> N/A] Baro Pot Calibrated
MAIN CDI CHECKOUT: <input type="checkbox"/> [<input type="checkbox"/> N/A] CDI (left, mid, right) <input type="checkbox"/> [<input type="checkbox"/> N/A] VDI (down, mid, up) <input type="checkbox"/> [<input type="checkbox"/> N/A] TO/FROM flag (OFF, TO, FROM) <input type="checkbox"/> [<input type="checkbox"/> N/A] Valid flags		AUXILIARY (GPS) CDI CHECKOUT: <input type="checkbox"/> [<input type="checkbox"/> N/A] CDI (left, mid, right) <input type="checkbox"/> [<input type="checkbox"/> N/A] VDI (down, mid, up) <input type="checkbox"/> [<input type="checkbox"/> N/A] TO/FROM flag (OFF, TO, FROM) <input type="checkbox"/> [<input type="checkbox"/> N/A] Valid flags
ANNUNCIATOR OUTPUTS CHECKOUT: <input type="checkbox"/> [<input type="checkbox"/> N/A] Message (MSG) <input type="checkbox"/> [<input type="checkbox"/> N/A] Parallel Track (PTK) <input type="checkbox"/> [<input type="checkbox"/> N/A] Suspend (SUSP) <input type="checkbox"/> [<input type="checkbox"/> N/A] Approach (APR) <input type="checkbox"/> [<input type="checkbox"/> N/A] Loss of Integrity (LOI) <input type="checkbox"/> [<input type="checkbox"/> N/A] Altitude Alert (ALT) <input type="checkbox"/> [<input type="checkbox"/> N/A] Precision Approach (PAA) <input type="checkbox"/> [<input type="checkbox"/> N/A] Terminal Mode (TRM) <input type="checkbox"/> [<input type="checkbox"/> N/A] Waypoint (WPT) <input type="checkbox"/> [<input type="checkbox"/> N/A] Back Course (BC) <input type="checkbox"/> [<input type="checkbox"/> N/A] GPS Indicator (GPS) <input type="checkbox"/> [<input type="checkbox"/> N/A] NAV Indicator (NAV) <input type="checkbox"/> [<input type="checkbox"/> N/A] Dead Reckoning (DR)		DISCRETE INPUTS CHECKOUT: <input type="checkbox"/> [<input type="checkbox"/> N/A] Com Flip-Flop <input type="checkbox"/> [<input type="checkbox"/> N/A] Com User List - UP <input type="checkbox"/> [<input type="checkbox"/> N/A] Com User List - DOWN <input type="checkbox"/> [<input type="checkbox"/> N/A] VOR Flip-Flop <input type="checkbox"/> [<input type="checkbox"/> N/A] OBI Select <input type="checkbox"/> [<input type="checkbox"/> N/A] Synchro Heading Valid <input type="checkbox"/> [<input type="checkbox"/> N/A] Remote Suspend <input type="checkbox"/> [<input type="checkbox"/> N/A] Audio Inhibit <input type="checkbox"/> [<input type="checkbox"/> N/A] Com PTT <input type="checkbox"/> [<input type="checkbox"/> N/A] Remote CDI Select

4 TROUBLESHOOTING

This section provides information to assist troubleshooting if problems occur after completing the installation. Use Table 4-1 to assist in troubleshooting. Devices connected to the GNS 480, such as an SL30, SL70 or MX20 can be useful for determining whether the GNS 480 is functioning properly or if there are problems with the installation.

4.1 TROUBLESHOOTING PROCEDURE

Table 4-1. Troubleshooting Guide		
Problem	Possible Cause	Solution
The GNS 480 does not power on.	<ul style="list-style-type: none"> The unit is not getting power to the main connector P1. 	<ul style="list-style-type: none"> Make sure power is connected to the main 37-pin connector P1-1 and 16 and ground to P1-2 and 20. Check circuit, breakers and main avionics switch.
The GNS 480 does not compute a position.	<ul style="list-style-type: none"> Not receiving signals, or incorrect seed position, time, and date. 	<ul style="list-style-type: none"> Make sure a correct position and time/date have been entered. Check the GPS antenna connections. Make sure the aircraft is clear of hangers, buildings, trees, etc.
GPS signal levels drop when avionics are turned on.	<ul style="list-style-type: none"> Noise interference from other avionics. 	<ul style="list-style-type: none"> Turn all avionics off, then turn on each piece one at a time to isolate the source of the interference. Route GPS cable and locate GPS antenna away from sources of interference.
The GPS signal levels are very low.	<ul style="list-style-type: none"> Improper antenna installation or coax routing. Antenna shaded from satellites. RF interference at 1575.42 MHz from VHF com. 	<ul style="list-style-type: none"> Check GPS antenna installation, connections, and cable routing. The GPS antenna must be mounted on the top of the aircraft. Make sure the aircraft is clear of hangers, buildings, trees, etc. Move GPS antenna further from the com antenna. Add a 1575.42 MHz notch filter in com coax. Fix or replace the com. Disconnect the ELT antenna coax to check for possible re-radiation.
Unable to control Com using COM bezel key.	<ul style="list-style-type: none"> No power to the com. The input voltage is too low. 	<ul style="list-style-type: none"> Make sure power is connected to the com 15-pin connector P4-1 and ground to P4-9. Increase input supply voltage to > 10 volts DC.
The GNS 480 does not transmit.	<ul style="list-style-type: none"> The PTT input is not being pulled low. No power to the com. The input voltage is too low. 	<ul style="list-style-type: none"> Check that the PTT (mic key) input is pulled low for transmit. Make sure power input is connected to the com 15-pin connector P4-1 and ground to P4-9. Increase input supply voltage to > 10 volts DC.

Table 4-1. Troubleshooting Guide		
Problem	Possible Cause	Solution
The sidetone level is too low or too high.	<ul style="list-style-type: none"> Wrong type of headsets, or level needs adjustment. 	<ul style="list-style-type: none"> If necessary, adjust the sidetone level. Sidetone adjustment is found under the AUDIO menu in the COM function.
Unable to control Nav using VOR bezel key.	<ul style="list-style-type: none"> No power to the nav receiver. 	<ul style="list-style-type: none"> Make sure power is connected to the nav 37-pin connector P7-1 and ground to P7-2.
OBS Resolver won't calibrate.	<ul style="list-style-type: none"> Incompatible resolver or improper connection. 	<ul style="list-style-type: none"> Check the resolver specifications and wiring.
OBS indication on GNS 480 does not agree with OBS setting	<ul style="list-style-type: none"> GNS 480 resolver input not configured correctly. Resolver has not been calibrated. 	<ul style="list-style-type: none"> Check resolver configuration in Ground Maintenance Mode Calibrate resolver
GNS 480 Message Audio or Tone not heard	<ul style="list-style-type: none"> Message audio volume level set too low Message tone is turned OFF. Audio inhibit line grounded 	<ul style="list-style-type: none"> Increase AMA volume level. AMA adjustment is found under the AUDIO menu in the COM function. Turn message tone ON via system configuration page. Verify that inhibit input (P5-77) is not grounded using Ground Maintenance Mode.
Unable to control transponder using XPDR bezel key.	<ul style="list-style-type: none"> SL70/SL70R transponder is not turned on. SL70 is not configured correctly. Wiring connections are incorrect. 	<ul style="list-style-type: none"> Turn on transponder Go to serial port setup page and verify that RS232 port 6 has SL70 set for both CH 6 RX and CH 6 TX. Check wiring.
GNS 480 not receiving baro correction data from MX20.	<ul style="list-style-type: none"> Incorrect configuration used for serial port to MX20. MX20 software prior to v5.x. Wiring connections are incorrect. 	<ul style="list-style-type: none"> Go to serial port setup page and verify that RS232 port 1 has MAPMX set for both CH 1 RX and CH 1 TX (only MX20 version 5.x or later supports the MAPMX protocol). Update MX20 software. Check wiring
DST data (Distance, Speed, Time) is not displayed on the SL30.	<ul style="list-style-type: none"> The GNS 480 is not configured correctly. The SL30 is not set up for DST display. 	<ul style="list-style-type: none"> Go to serial port setup page and verify that RS232 port to SL30 is set to SL30 on RX and MAPCOM on TX. Consult SL30 users guide for setup of DST display.

Table 4-1. Troubleshooting Guide		
Problem	Possible Cause	Solution
GNS 480 is not receiving heading from compass system (ARINC 429 heading input used)	<ul style="list-style-type: none"> • GNS 480 ARINC 429 input not configured correctly. • ARINC 429 input port speed not correct • Wiring connections are incorrect. 	<ul style="list-style-type: none"> • Check ARINC 429 input port setting for port that device is connected to. • Check ARINC 429 input port speed setting for port that device is connected to and verify that the speed is correct for that device. • Check wiring.
GNS 480 is not receiving heading from compass system (synchro heading input used)	<ul style="list-style-type: none"> • Heading Valid input invalid. • 26VAC reference voltage is incorrect • Wiring connections are incorrect 	<ul style="list-style-type: none"> • Check that heading valid input (P5-57) is > 9 VDC. State of this input can be checked in Ground Maintenance Mode. • Check that 26VAC, 400Hz reference is supplied to P5-20,39 • Check wiring.
GNS 480 heading differs greatly from compass system (synchro hdg only)	<ul style="list-style-type: none"> • Synchro X,Y,Z legs are crossed • 26VAC reference Hi and Lo are swapped. • 26VAC reference supplied to GNS 480 is different than 26VAC reference used by compass system. 	<ul style="list-style-type: none"> • Check wiring. • Check wiring. • Verify that GNS 480 and compass system are using the same 26VAC reference.
GNS 480 is not receiving baro-correction setting from altimeter	<ul style="list-style-type: none"> • GNS 480 baro pot input not configured correctly. • GNS 480 baro pot input not calibrated • GNS 480 is not the only device tied to the altimeter baro pot 	<ul style="list-style-type: none"> • Check baro pot configuration in Ground Maintenance Mode • Calibrate baro pot • Ensure GNS 480 is the only device connected to the altimeter baro pot
Autopilot is not getting GPSS/Roll Steering data from the GNS 480 (ARINC 429 Roll Steering used)	<ul style="list-style-type: none"> • GNS 480 does not have a position or flight plan entered. • GNS 480 ARINC 429 output not configured correctly. • ARINC 429 output port speed not correct • Wiring connections are incorrect. 	<ul style="list-style-type: none"> • Acquire GPS position and enter a flight plan. • Check ARINC 429 output port setting for port that autopilot is connected to. • Check ARINC 429 output port speed setting for port that autopilot is connected to and verify that the speed is correct for autopilot. • Check wiring.
Autopilot is not getting GPSS/Roll Steering data from the GNS 480 (RS232 Roll Steering used)	<ul style="list-style-type: none"> • GNS 480 RS232 output not configured correctly. • Wiring connections are incorrect. 	<ul style="list-style-type: none"> • Ensure output port setting is MAPCOM for port that autopilot is connected to. • Check wiring.
RMI pointer does not indicate correctly	<ul style="list-style-type: none"> • Desired RMI source has not been selected • Wiring connections are incorrect. 	<ul style="list-style-type: none"> • Select desired RMI source from Nav or GPS. • Check wiring
Tuning data not updating DME	<ul style="list-style-type: none"> • DME Select is not low • Wiring connections are incorrect. 	<ul style="list-style-type: none"> • Verify DME Select pulled low. • Check wiring.

Table 4-1. Troubleshooting Guide

Problem	Possible Cause	Solution
ARINC 429 device is not receiving data from the GNS 480.	<ul style="list-style-type: none"> • GNS 480 ARINC 429 output not configured correctly. • ARINC 429 output port speed not correct • Wiring connections are incorrect. 	<ul style="list-style-type: none"> • Check ARINC 429 output port setting for port that device is connected to. • Check ARINC 429 output port speed setting for port that device is connected to and verify that the speed is correct for that device. • Check wiring.
RS232 device is not communicating with the GNS 480.	<ul style="list-style-type: none"> • GNS 480 RS232 port not configured correctly. • Improper setup on the remote device. • Device not compatible, or improper connection. • Multiple Tx lines connected together (not applicable to dual GNS 480's controlling the SL70). 	<ul style="list-style-type: none"> • Check RS232 port setting for port that device is connected to. • Verify the configuration of the other device. • Verify GNS 480 Rx is connected to remote device Tx and GNS 480 Tx is connected to remote device Rx. • Verify that there is only one Tx source per Rx port (not applicable to dual GNS 480's controlling the SL70).

4.2 CONTACTING THE FACTORY FOR ASSISTANCE

If the GNS 480 unit fails to operate despite troubleshooting efforts, contact Garmin Technical Support for assistance.

GARMIN International, Inc.
 1200 East 151st Street
 Olathe, KS 66062-3426
 USA

Phone: (913) 397-8200
 FAX: (913) 397-8282

<http://www.garmin.com>

Be prepared to offer the following information about the installation:

- Installation configuration (list of any accessories)
- Model number, part number with mod levels, and serial number
- Software Versions
- Description of problem
- Efforts made to isolate the problem

5 LIMITATIONS

5.1 OPERATION

There are no Part 23 aircraft type limitations. All functions of the GNS 480 meets the appropriate design assurance qualifications for primary or secondary for airplane Class I, Class II, Class III, and Class IV in accordance with AC 23.1309-1C Figure 2. The TSO authorizations with the RTCA/DO178B software levels by function are listed in Table 1-1.

TSO-C146a defines loss of function of en route, terminal, nonprecision approach, or precision approach navigation data as a major failure condition. AC 23.1309-1C provides guidance for IFR airplanes that classifies total loss of function as a major failure condition, and loss of primary means of function as minor if two navigation systems are installed. One method to meet the major failure condition for loss of function is to install redundant systems. It is recommended that the aircraft be equipped with at least two independent navigation receivers and two independent communication transceivers for IFR use. For independent navigation systems, two GNS 480 units may be used, or a combination of GNS 480 and an independent Nav/Com unit may be used. This will support a System Safety Assessment of minor for IFR operations. Refer to AC 23.1309-1C.

The installation of a GNS 480 into an aircraft does not alter the operational approvals previously granted to that aircraft. Additional operation approvals may require FAA evaluation of all the systems installed in a particular aircraft and is outside the scope of the GNS 480 STC.

5.2 INSTALLATION

The conditions and test required for TSO approval of this article are minimum performance standards. It is the responsibility of those installing this article either on or within a specific type or class of aircraft to determine that the aircraft installation conditions are within the TSO standards. TSO articles must have separate approval for installation in an aircraft. The article may be installed only if performed under 14 CFR part 43 or the applicable airworthiness requirements.

The GNS 480 WAAS/GPS receiver and antenna are compatible with aircraft equipped with SATCOM.

5.2.1 GPS ANTENNA

The WAAS/GPS receiver is only compatible with the Garmin AT A-33 (590-1104) or A-34 (590-1112) antennas, or those with equivalent specifications. Refer to section 1.3.10.1 for specifications.

5.2.2 ANTENNA INSTALLATION – GENERAL

Antenna installation in the pressure vessel of pressurized aircraft is beyond the scope of the GNS 480 STC. Additional manufacturer's data may be necessary and FAA approval may be required to cover the installation of any antenna in the pressure vessel of a pressurized aircraft.

5.2.3 EQUIPMENT INTERFACED TO THE GNS 480

GNS 480 interfaces to aircraft systems other than those shown in this installation manual are outside the scope of this manual and may require further evaluation and/or certification approval.

All equipment interfaced to the GNS 480 must be previously or concurrently approved.

5.2.4 PRESERVATION OF PREVIOUS SYSTEMS

It is the installer's responsibility to preserve the essential characteristic of the aircraft being modified by this manual to be in accordance with the aircraft manufacturer's original design. This includes the preservation of multiple power buses, which reduce the probability of interrupting power to essential instruments and avionics. For Aircraft on the AML certified under 14 CFR Part 23 post amendment 41, use of the GNS 480 for IFR operations requires a functional redundant electrical power system.

5.3 AIRCRAFT RADIO STATION LICENSE

An aircraft radio station license is not required when operating in U.S. airspace, but may be required when operating internationally.

6 PERIODIC MAINTENANCE

6.1 EQUIPMENT CALIBRATION

No scheduled servicing tasks are required on the GNS 480. The GNS 480 design requires **no** internal manual adjustments.

6.2 VOR CHECKS

Even though the GNS 480 is designed to utilize the most state-of-the-art DSP technology and maintain a very high accuracy and repeatability record, it still must undergo the VOR accuracy check required for IFR flight. Refer to CFR 14 paragraph 91.171. Every 30 days verify the limits of the permissible indicated bearing error.

The last VOR check information may be entered into the GNS 480 via the Nav VOR Mode then on the Test Log Menu page.

6.3 CLEANING

The front bezel, keypad, and display can be cleaned with a soft cotton cloth dampened with clean water. **DO NOT** use any chemical cleaning agents. Care should be taken to avoid scratching the surface of the display.

6.4 BATTERY REPLACEMENT

The GNS 480 includes an internal battery that will last about 10 years. The battery is used for internal RAM memory and GPS system information. Regular planned replacement is not necessary. The GNS 480 will display a "low battery" message when replacement is required. Once the low battery message is displayed, the battery should be replaced within 1 to 2 months.

If the battery is not replaced and becomes totally discharged, the GNS 480 will remain fully operational, but the GPS signal acquisition time will be increased. This acquisition time can be reduced by entering a new seed position each time the unit is powered on. There is no loss of function or accuracy of the GNS 480 with a dead battery.

The battery is not user replaceable. To replace the battery, contact the Garmin AT repair station or factory authorized repair station.

6.5 DISPLAY BACKLIGHT

The display backlight is rated by the manufacturer as having a usable life of 20,000 hours. This life may be more or less than the rated time depending on the operating conditions of the GNS 480. Over time, the backlight will dim and the display will not perform as well in direct sunlight conditions. The user must determine by observation when the display brightness is not suitable for its intended use. Contact Garmin AT repair station or factory authorized repair station when the backlight requires service.

NOTES

APPENDIX A - CERTIFICATION DATA

A.1 ENVIRONMENTAL QUALIFICATION

The GNS 480 has been tested to the following environmental categories per procedures defined in RTCA/DO-160D. Tests were conducted from September 2002 to April 2003 using the original 1997 revision of DO-160D and specification defined in PD3107.

Environmental Qualification Form		
Nomenclature: GNS 480 Part No.: 430-6100-8xx-xxx TSO No.: C34e, C36e, C37d, C38d, C40c, C113, C128, C146a		Manufacturer: Garmin AT 2345 Turner Road SE Salem, Oregon 97302
Conditions	Section	Description of Conducted Tests
Temperature and Altitude	4	Equipment tested to Category C1 & A1 Operating temp: -20°C to +55°C Short time high temp: to +70°C Ground survival temp: -55°C to +85°C Altitude: 35,000 feet Decompression: 55,000 feet [1] Overpressure (non-operating) No external cooling required provided internal fans are unobstructed and operating. [2]
Temperature Variation	5	Equipment tested to Category C, 2°C/min
Humidity	6	Equipment tested to Category A, standard humidity environment
Operational Shocks and Crash Safety	7	Equipment tested for both operational and crash safety shocks to Category B Type 5R Equipment operated normally after crash shocks. (20 Gs at 11 msec (impulse) and 3 sec (sustained))
Vibration	8	Equipment tested without shock mounts to Category S (Curves B, M) and Category U (curves F, F1)
Explosion Proofness	9	Equipment identified as Category X, no test required
Waterproofness	10	Equipment identified as Category X, no test required
Fluids Susceptibility	11	Equipment identified as Category X, no test required
Sand and Dust	12	Equipment identified as Category X, no test required
Fungus Resistance	13	Equipment identified as Category X, no test required
Salt Spray	14	Equipment identified as Category X, no test required
Magnetic Effect	15	Equipment is Class Z (Dc is at 0.185 meters)
Power Input	16	Equipment tested to Category A & B (14 and 28 VDC system)
Voltage Spike	17	Equipment tested to Category A
Audio Frequency Conducted Susceptibility - Power Inputs	18	Equipment tested to Categories A & B
Induced Signal Susceptibility	19	Equipment tested to Category C
Radio Frequency Susceptibility (Radiated and Conducted)	20	Equipment tested to Category VV- (Category V Conducted, Category V Radiated. No Pulsed test performed.)
Emission of Radio Frequency Energy	21	Equipment tested to Category M
Lightning Induced Transient Susceptibility	22	Equipment identified as Category A3 B2
Lightning Direct Effects	23	Equipment identified as Category X, no test required
Icing	24	Equipment identified as Category X, no test required
Electrostatic Discharge (ESD)	25	Equipment tested to Category A
Remarks: [1] Operation at 55,000 feet verified for 30 minutes following decompression. [2] Also passed Category P In Flight Loss of Cooling (180 min at +30 °C) with internal fans not operating. •Passed the Thermal Shock test (+55C to -20C in < 20 sec) required by TSO C113 (per AS8034 paragraph 5.23). •Passed the Operating Overpressure test (170 kPa) required by TSO C113 (per AS8034 paragraph 5.2.5). •Passed GPS L1 Radiated Susceptibility test (20 mV/meter) required by TSO C146a (per DO-229C para 2.4.1.2.3).		

A.2 GNS 480 STC DATA

Refer to Garmin AT document 560-0988-00 for data regarding GNS 480 STC authorization. This document contains information on the following items:

- Supplementary Type Certificate (STC)
- STC Permission
- STC Master Data List
- Airplane Flight Manual (AFM) Supplement
- Instructions for Continued Airworthiness (ICA)

APPENDIX B - SERIAL INTERFACE SPECIFICATIONS

This appendix includes the RS232 serial port interface specifications.

The RS-232 serial interface configurations supported by the GNS 480 are described below. Instructions for configuring the serial port are included in the checkout procedure in section 3.2.1.1. Serial output connections should be limited to a maximum of three external units.

B.1 SERIAL INPUT SPECIFICATIONS

Available settings for the serial inputs are listed in Figure 3-2. Not all settings are available on each serial input port – refer to section 3.2.1.1 to determine which settings are available on a given port.

RX	Comment	Reference
NONE	No input connected.	N/A
MAPMX	Proprietary interface between GNS 480 and MX20 v5.0 or later. This interface will support auto chart selection, flight plans, zoom scale matching, altimeter correction, and ILS and VOR navigation information. (MUST BE USED WITH MAPMX SELECTED ON SAME OUTPUT PORT)	N/A
CROSSFILL	Proprietary interface to second GNS 480 for cross-talking data (MUST BE USED WITH GNS 480 SELECTED ON SAME OUTPUT PORT)	N/A
ALTENC	Altitude encoder data.	B.1.1
FADC	Fuel/Air Data Computer data.	B.1.2
SL30	Tuned Nav station data. Refer to SL30 installation manual.	560-0404-xx
SL70	SL70/SL70R mode control and altitude data. Refer to SL70 installation manual.	560-0402-xx
IRDA	Not currently supported.	N/A
GTX32	Proprietary interface between GNS 480 and GTX 32/327 transponder for mode control.	N/A
GTX33/ GTX33+TIS	Proprietary interface between GNS 480 and GTX 33/330 transponder for mode control (and optional TIS traffic).	N/A
COG	Proprietary interface between GNS 480 and Carbon Monoxide Guardian.	N/A

B.1.1 Altitude Encoder/Converter Input

The GNS 480 will accept various serial altitude formats. The only configuration required for the altitude encoder input is the baud rate – the serial altitude format will be recognized automatically. The input signals shall be compatible with RS-232C and have the following characteristics:

- Baud rate:1200/9600 (defined by encoder used)
- Data bits:8
- Stop bits:1
- Parity:none
- Expected input rate:approx. 1 second
- Message length:17 characters

B.1.1.1 Apollo Altitude Format

The Apollo (Ilmorrow) altitude format is 1200 baud with a message length of 17 characters, as defined in Table B- 2. Several sample messages are illustrated in Figure B- 1.

Byte	Data Format	Description
1	"#"	ASCII "#" (023h)
2	"A"	ASCII "A" (041h)
3	"L"	ASCII "L" (04Ch)
4	" "	ASCII space (020h)
5	"+" or "-"	Altitude sign: ASCII "+" or "-" (02Bh or 02Dh)
6-10	dddd	Altitude in feet, right justified with leading zeros
11	"T"	ASCII "T" (054h)
12	"+" or "-"	Temperature sign: ASCII "+" or "-" (02Bh or 02Dh)
13-14	dd	Internal altimeter temperature
15-16	dd	Checksum of bytes 1 through 14, computed in hex, output in ASCII format (i.e., "FA" hex)
17	<CR>	ASCII carriage return (0Dh)

The altitude input can decode several status or error codes. These codes would be in place of the altitude data in characters 5 - 10 as follows.

- "-09980"Heater not ready: expected during encoder warm-up or if there is a loss of signal from the encoder.
- "-09981"Possible hardware problem: expected from encoder indicating a temperature greater than 55°C or if data is invalid.
- "-09982"Altitude out of range: expected from the encoder indicating that the altitude is outside specified range of the encoder.

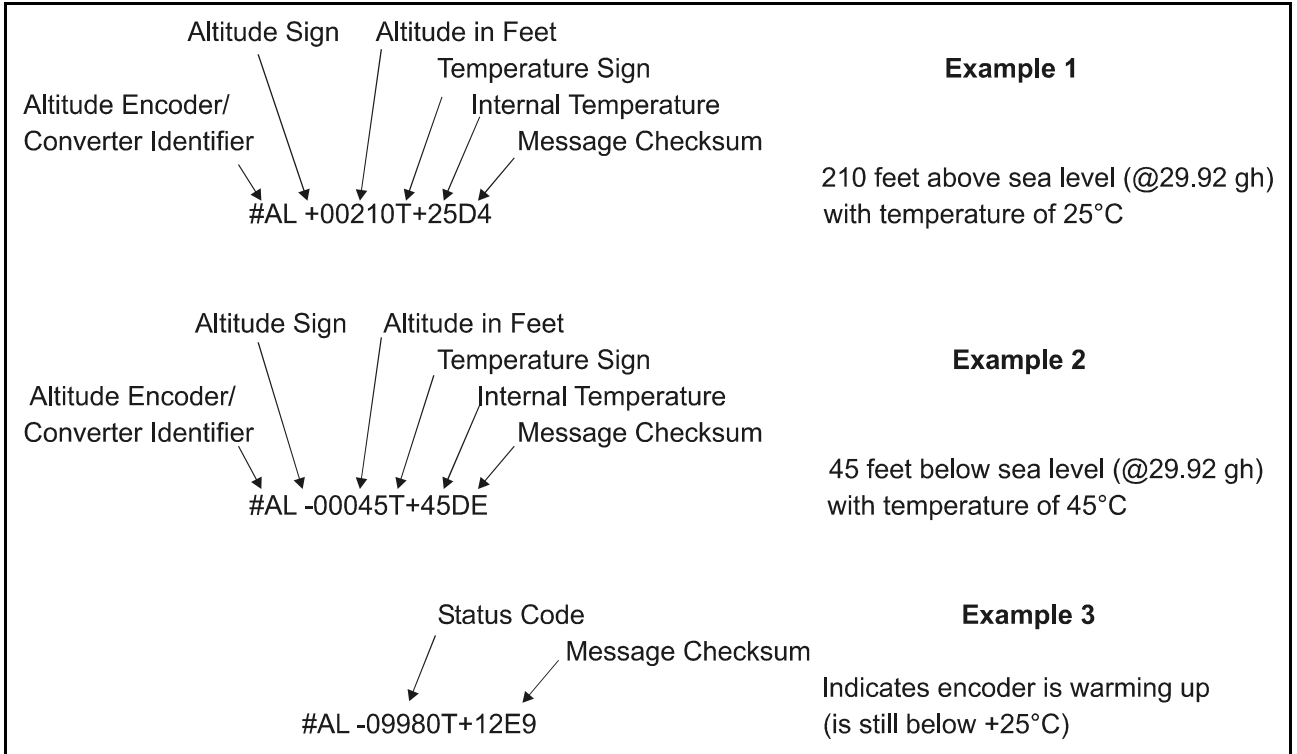

Figure B- 1 - Altitude Data Input

B.1.1.2 Shadin Altitude Format

The Shadin altitude format is 9600 baud with a message length of 17 characters, as defined below:

RMS<sp><+/->**12345T**<+/->**12ul**<CR>

where:

- RMS** ASCII characters
- <sp>** space (0x20)
- <+/->** sign indicator (0x2b["+"] or 0x2d["-"])
- 12345** altitude in feet
- T** ASCII character
- <+/->** sign indicator
- 12** sensor temperature
- ul** checksum of bytes 1 through 14 in hex ASCII (e.g., "FA")
- <CR>** carriage return (0x0d)

Note: Checksum is calculated by adding each byte in the message (1 through 14).

B.1.2 Fuel/Air Data Computer Input

The fuel/air data input is used to input fuel flow and airdata computer information from the fuel/air data computer. Both the Shadin “S” format and Shadin “Z” format data are automatically accepted.

B.1.2.1 “S” Data Format

The format of the fuel/air data computer input is as follows, which conforms to the Shadin “S” format serial message. Definition of the input message data that the GNS 480 uses is included in Table B- 3. A sample input message is illustrated in Figure B- 2.

Baud rate:9600
 Data bits:8
 Stop bits:1
 Parity:none
 Expected input rate:approx. 1 second
 Message length:variable (512 character max.)

The serial input message string is expected in the following format.

<STX><message><message> ... <message><checksum><ETX>
 <STX>.....ASCII “start of text” character (STX = 02h)
 <message>.....starts with an ASCII “S”, then an ID character, followed by the message data, a carriage return (CR = 0Dh), and a line feed (LF = 0Ah) See the following table. s = a sign indicator (-,+E,W). d = a decimal digit (0-9)
 <checksum>.....the message checksum, same format as message
 <ETX>.....ASCII “end of text” character (ETX = 03h)

Table B- 3 - Fuel/Air Data Message Data (S Format)

Item Desig	Message Format	Message Mnemonic	Field Width	Message Description
SA	ddd	IAS	7	Indicated Air Speed in knots
SB	ddd	TAS	7	True Air Speed in knots
SC	ddd	MACH	7	Mach Speed in thousandths
SD	sdddd	PALT	9	Pressure Altitude in tens of feet, +/- sea level
SE	sdddd	DALT	9	Density Altitude in tens of feet, +/- sea level
SF	sdd	OAT	7	Outside Air Temp - or “Total”, in degrees Celsius
SG	sdd	TAT	7	True Air Temp - or “Static”, in degrees Celsius
SH	ddd	WDIR	7	Wind Direction, 0 to 359 degrees from true north
SI	ddd	WSPD	7	Wind Speed in knots
SJ	sdd	TURN	7	Rate of Turn in +/- degrees/second, + is right, - is left
SK	sddd	VSPD	8	Vertical speed in tens of feet/minute
SL	ddd	HEAD	7	Heading, 0 to 359 degrees from true north
SM	dddd	RFF	8	Right Engine Fuel Flow in tenths of gallons/hour
SN	dddd	RFU	9	Right Engine Fuel Used in tenths of gallons
SO	dddd	LFF	8	Left Engine Fuel Flow in tenths of gallons/hour
SP	dddd	LFU	9	Left Engine Fuel Used in tenths of gallons
SQ	ddd	ERR	7	Error Log / Reason Indicator: 001 = temp sensor error; 000 = no errors

Table B- 3 - Fuel/Air Data Message Data (S Format)				
Item Desig	Message Format	Message Mnemonic	Field Width	Message Description
SR	dddd	REM	10	Fuel remaining (0-9999.9 in gallons)
S*	ddd	CKSUM	7	Checksum of all characters preceding this record. The checksum is a one byte checksum (discarding carries) including all characters from the initial STX up to and including the line feed preceding the checksum message.

Example Fuel / Airdata Input Data	
<STX>SA223	223 knots indicated air speed
SB230	230 knots true air speed
SC101	0.101 mach
SD+3200	32,000 feet pressure altitude
SE+3312	33,120 feet density altitude
SF+05	+5°C outside air temp
SG-03	-3°C true air temp
SH010	wind direction at 10° (relative to true north)
SI015	wind speed at 15 knots
SJ+03	+3° / second right turn
SK-050	-50 feet / second vertical air speed
SL359	359° heading (relative to true north)
SM0123	12.3 gallons / hour - right engine fuel flow
SN0300	30.0 gallons used - right engine
SO0131	13.1 gallons / hour - left engine fuel flow
SP0310	31.0 gallons used - left engine
SQ000	no errors
SR01227	122.7 gallons remaining
S*123	Checksum (example only, not actual)
<ETX>	end of message string

Figure B- 2 - Fuel / Air Data Input (S Format)

B.1.2.2 “Z” Data Format

The format of the fuel/air data computer input is as follows, which conforms to the Shadin “Z” format serial message. Definition of the input message data that the GNS 480 uses is included in Table B- 4.

Baud rate: 9600
 Data bits: 8
 Stop bits: 1
 Parity: none
 Expected input rate: approx. 1 second
 Message length: variable (512 character max.)

The serial input message string is expected in the following format.

<STX><message><message> ... <message><chksum><ETX>

- <STX>ASCII “start of text” character (STX = 02h)
- <message>starts with an ASCII “Z”, then an ID character, followed by the message data, a carriage return (CR = 0Dh), and a line feed (LF = 0Ah) See the following table.
- <checksum>the message checksum, same format as message
- <ETX>ASCII “end of text” character (ETX = 03h)

Item Desig	Message Format	Message Mnemonic	Field Width	Message Description
ZA	ddd	IAS	7	Indicated Air Speed in knots
ZB	ddd	TAS	7	True Air Speed in knots
ZC	ddd	MACH	7	Mach Speed in thousandths
ZD	sdddd	PALT	9	Pressure Altitude in tens of feet, +/- sea level
ZE	sdddd	DALT	9	Density Altitude in tens of feet, +/- sea level
ZF	sdd	OAT	9	Outside Air Temp - or “Total”, in degrees Celsius
ZG	sdd	TAT	7	True Air Temp - or “Static”, in degrees Celsius
ZH	ddd	WDIR	7	Wind Direction, 0 to 359 degrees from true north
ZI	ddd	WSPD	7	Wind Speed in knots
ZJ	sdd	TURN	7	Rate of Turn in +/- degrees/second, + is right, - is left
ZK	sddd	VSPD	8	Vertical speed in tens of feet/minute
ZL	ddd	HEAD	7	Heading, 0 to 359 degrees from true north
ZM	dddd	RFF	8	Right Engine Fuel Flow in tenths of gallons/hour
ZN	dddd	RFU	9	Right Engine Fuel Used in tenths of gallons
ZO	dddd	LFF	7	Left Engine Fuel Flow in tenths of gallons/hour
ZP	dddd	LFU	9	Left Engine Fuel Used in tenths of gallons
ZQ	ddd	ERR	7	Error Log / Reason Indicator: 001 = temp sensor error; 000 = no errors
ZR	ddd	CKSM1	7	Checksum of labels A to Q (0 to 255)
ZS	ddd	GSP	7	Ground speed (0-999 knots)
ZT	ddd	TRK	7	Track (0 to 359 degrees, magnetic)
ZU	dddddd	DIS	1	Distance to Destination (0 to 999999, nm * 100)
ZV	sddd	MVAR	8	Magnetic Variation (0 to 999 degrees, deg * 10), s = E or W where E = east, W = west
ZW	sddmmhh	LAT	13	Current Latitude, s = N or S, dd = degrees, mm = minutes
ZX	sddmmhh	LON	14	Current Longitude, s = E or W, ddd = degrees, mm = minutes, hh = hundredths of minutes
ZY	ddd	CKSM2	7	Checksum of labels S to X (0 to 255)

B.2 SERIAL OUTPUT SPECIFICATIONS

Available settings for the serial outputs are listed in Table B- 5. Not all settings are available on each serial output port – refer to section 3.2.1.1 to determine which settings are available on a given port.

Table B- 5 - RS-232 Serial Output (TX) Selections		
TX	Comment	Reference
NONE	No input connected.	N/A
MAPMX	Proprietary interface between GNS 480 and MX20 v5.0 or later. This interface will support auto chart selection, flightplans with the new flight legs, zoom scale matching, altimeter correction, and ILS and VOR navigation information. (MUST BE USED WITH MAPMX SELECTED ON SAME INPUT PORT)	N/A
GNS 480	Proprietary interface to second GNS 480 for cross-talking data (MUST BE USED WITH GNS 480 SELECTED ON SAME INPUT PORT)	N/A
MAPCOM	Moving map output data, nearest waypoint data, annunciator data, flight plan waypoints and nav/com data.	B.2.1
SL70	SL70/SL70R mode control and altitude data. Refer to SL70 installation manual.	560-0402-xx
IRDA	Not currently supported.	N/A
GTX32	Proprietary interface between GNS 480 and GTX 32/327 transponder for mode control.	N/A
GTX33 / GTX33+TIS	Proprietary interface between GNS 480 and GTX 33/330 transponder for mode control (and optional TIS traffic).	N/A

B.2.1 Mapcom Output

When MAPCOM is selected, the GNS 480 will transmit moving map data, nearest waypoint data, flight plan waypoints, and nav/com data on this output. The format of the MapCom output is as follows:

Baud rate: 9600
 Data bits: 8
 Stop bits: 1
 Parity: none
 Output rate: approx. 1 sec.
 Message length: variable, approx. 164 to 958 bytes

Moving map data, nearest waypoint data, and flight plan waypoints are embedded within a packet of data, enveloped by <STX> and <ETX> characters. NavComm data uses a different packet protocol, which does not use the <STX> and <ETX> characters.

As an example, a snapshot representation of 1 second worth of messages would look like the following:

```
<STX>
<id><data><it>
<id><data><it>...
<id><data><it><ETX>
$PMRRC<msg_id><msg_data><chksum><it>
$PMRRC<msg_id><msg_data><chksum><it>...(no ETX character).
```

And, the sequence begins again.

B.2.1.1 Moving Map Data

Definitions of the Moving Map output data are included in Table B- 6 and Table B- 7. A sample output message is included in Figure B-3.

The serial output messages are in the following format.

```

<STX><id><data><it><id><data><it>...<id><data><it><ETX>
<STX> .....ASCII "start of text" character (1 byte, 02h)
<id> .....item designator (1 byte, from following table)
<data> .....item data (format listed in following table)
<it> .....item terminator (1 byte, 0Dh)
<ETX> .....ASCII "end of text" character (1 byte, 03h)
    
```

Table B- 6 - Moving Map ASCII Navigation Data

ID	Data Format	Length	Description
A	sddmmhh	7	Present latitude s = sign: N for north, S for south dd = degrees mm = minutes hh = hundredths of minutes
B	sdddmmhh	8	Present longitude s = sign: E for east, W for west ddd = degrees mm = minutes hh = hundredths of minutes
C	ddd	3	Track (magnetic): ddd = degrees
D	ddd	3	Ground speed: ddd = knots
E	dddd	5	Distance to active waypoint: ddddd = nm x 10
G	sddd	5	Cross track error: s = sign: R for right, L for left of course ddd = distance off course, hundredths of nm
I	ddd	4	Desired track (magnetic): ddd = degrees x 10
K	ddd[dd]	3 to 5	Active waypoint identifier: ddd[dd] = ASCII waypoint identifier
L	ddd	4	Bearing to active waypoint (magnetic): ddd = degrees x 10
Q	sddd	4	Magnetic variation: s = sign: E for east, W for west ddd = degrees x 10
T	---A----	9	Warnings: The 4th character will be an "A" when the navigation data is flagged, otherwise, all characters will be dashed. All other navigation data will be dashed when it is flagged.
a	eamphT	8	Annunciator Flags: e = Approach Enabled { '-' (off) 'O' (on) } a = Approach Active { '-' (off) 'O' (on) 'B' (blink) } m = Message { '-' (off) 'O' (on) 'B' (blink) } p = Parallel Track { '-' (off) 'O' (on) } h = Hold { '-' (off) 'O' (on) 'B' (blink) } t = From/To { '-' (off) 'T' (To) 'F' (From) }

Table B- 6 - Moving Map ASCII Navigation Data			
ID	Data Format	Length	Description
c	vDddd	7	CDI: v = Nav Flag { '-' Flagged 'v' Valid } D = Needle { 'C' Center 'L' Left 'R' Right } ddd = Deflection Value ASCII (000 – 100)
l (lower case L)	dddddd	6	Distance to Destination: dddddd = nm * 10
p	sdddd	7	s = ± dddd = {0000 - 5999} Pressure Altitude (-1500 to +5999 tens of feet +/- sea level). Field is dashed when invalid "----".
v	vDddd	7	VDI: v = VDI Flag { '-' Flagged 'v' Valid } D = Needle { 'C' Center 'U' Up 'D' Down } ddd = Deflection Value ASCII (000 – 120)
h	sddd	4	Horizontal Command Signal: s=sign: L = bank left. R = bank right. X = invalid data. ddd = degrees * 10
w	See Table B- 7	18	Moving Map Binary Route Data

Table B- 7 - Moving Map Binary Route Data		
Byte	Data Format	Description
1	w	Item designator
2-3	dd	Current waypoint number in ASCII (01h to 20h)
4	xiannnnn	Sequence number x = undefined i = 1 if last waypoint a = 1 if active waypoint nnnn = unsigned binary waypoint number
5-9	dddddd	ASCII waypoint identifier
10	sddddddd	Waypoint latitude - packed, unsigned binary s = sign: 0 for north, 1 for south ddddddd = degrees mmmmmm = minutes hhhhhhh = hundredths of minutes x = undefined
11	xxmmmmmm	
12	xhhhhhhh	
13	sxxxxxxx	Waypoint longitude s = sign: 0 for east, 1 for west ddddddd = degrees mmmmmm = minutes hhhhhhh = hundredths of minutes x = undefined
14	ddddddd	
15	xxmmmmmm	
16	xhhhhhhh	
17	nnnnnnnn	Magnetic variation at waypoint LS byte (msbit...lsbit) MS byte (msbit...lsbit) Two's complement binary in sixteenths of degrees, easterly variation is positive.
18	nnnnnnnn	
19	<CR>	ASCII carriage return (0Dh)

B.2.1.2 Binary Nearest List Data

The nearest waypoint lists are sent one waypoint per data transmission set. The lists are sent in the following order:

- LFAC
- VOR
- NDB
- INT
- User

There is a maximum of twenty waypoints per type. The waypoints are a maximum of 600 nm from the current position. The waypoints are order by distance from current position nearest to farthest. The maximum time to send all lists is 100 seconds. Each list is updated just prior to the first waypoint in the list being sent. If a list is empty a shorter record will be sent with the List Item Number set to 0xFF.

Table B- 8 - Nearest Waypoint List Data

Byte	Format	Description
1	Z	'Z' Item Designator
2	sddddddd	List Item Number: Packed, unsigned binary values s = 1 End of list, 0 all other ddddddd = 1 – 20 list waypoint index sddddddd = 0xFF List Type is EMPTY (BYTE 4 terminate Item)
3	t	Waypoint Type: t = {a (airport) v (VOR) n (NDB) i (INT) u (USER)}
4	Cr	'r' Item Terminator <0x0d> (ONLY IF BYTE 2 = 0xFF)
4-8	dddd	ASCII Waypoint Identifier
9 10 11	sddddddd xxmmmmmm xhhhhhhh	Latitude of waypoint. Packed, unsigned binary values for degrees, minutes and hundredths of minutes. s = 0 North latitude, 1 South latitude x = undefined ddddddd = Latitude degrees mmmmmm = Latitude minutes hhhhhhh = Latitude hundredths of minutes
12 13 14 15	sxxxxxxx ddddddd xxmmmmmm xhhhhhhh	Longitude of waypoint. Packed, unsigned binary values for degrees, minutes and hundredths of minutes. s = 0 East longitude, 1 West longitude x = undefined ddddddd = Longitude degrees mmmmmm = Longitude minutes hhhhhhh = Longitude hundredths of minutes
16	Cr	'r' Item Terminator <0x0d>

B.2.1.3 Flight Plan Waypoint Type Data

The following data is only transmitted when preceded by flight plan data. There is one character per flight plan waypoint transmitted.

Table B- 9 - Flight Plan Waypoint Type			
Id	Item Format	Len	Description
t	nnn...	1-21	n = { a (airport) v (VOR) n (NDB) i (intersection) u (user) p (parallel track) d (direct to) F (FAF) E (DME) I (IAF) H (MAHP) M (MAP) A (IFAF) P (undefined approach waypoint type) }

Example Moving Map Data Output

```

AN 34 1570      34°15.70' latitude
BW 118 4390    118°43.90' longitude
C306           306° track angle
D210           210 knots
E02682        268.2nm to waypoint
GR0006        0.6nm right of course
I3059         305.9° desired track
KSFO          SFO waypoint ident
L3058         305.8° bearing to waypoint
QE140         14.0° east magnetic variation
T-----      No alarms, data not flagged
<binary data> From Table B- 7
a----F        Approach Enabled Off, Active Off, Message On, Parallel Track
                Off, Hold Off, and From/To is FROM
cvR001        CDI Valid, Needle Right, Deflection 001°
p+0008        Pressure Altitude, +80 ft
vC000         VDI Valid, Needle Centered, Deflection is 000°
<binary data> From Table B- 7
tda          Flight Plan Waypoint Type data, direct-to, airport type

```

Figure B- 3 - Moving Map Data Output**B.2.1.4 NavComm Data**

The definition of the NavComm portion of the MapCom data output is as follows. This data output is compatible with the SL30 or SL40 for sending frequency data to the comm or nav unit.

The comm data is output using the following format.

```
$PMRRC<msg_id><msg_data><chksum><cr>
```

\$PMRRV<msg_id><msg_data><chksum><cr>

The checksum is computed by an 8 bit addition of the msg_id and msg_data characters, ignoring carry if any. The resulting 8 bit checksum is converted to two ASCII characters by taking the upper and lower nibbles, adding 30h to each, and placing the most significant character first in the data message.

B.2.1.4.1 Airport Ident Output

This message is used to output the selected airport ident.

Message Format

\$PMRRC04tiii<chksum><cr>

04 message id
 t list type, outputs a 1
 iii ident, four character ASCII

Example Message

\$PMRRC041SLE<space>99<cr>

Output ident of "SLE" for the following frequency information.

B.2.1.4.2 Frequency Data Output

This message is used to output the airport frequency information for the previously output ident.

Message Format

\$PMRRC05tfmk<chksum><cr>

05 message id
 t list type, input 1
 f frequency type:
 0 = TWR, tower frequency 8 = CTF, common traffic advisory frequency
 1 = GND, ground frequency 9 = DEP, departure
 2 = ATS, for ATIS : (3Ah) = FSS, flight service station
 3 = ATF, air traffic frequency ; (3Bh) = RFS, for remote flight service station
 4 = APP, for approach < (3Ch) = UNI, for unicom
 5 = ARR, for arrival = (3Dh) = MF, mandatory frequency
 6 = AWS, automatic weather station > (3Eh) = CTR (Center)
 7 = CLR, clearance/delivery ? (3Fh) = undefined, for other frequency types

mk frequency:
 m = desired frequency in MHz in hexadecimal, where m = desired frequency - 30h , with the desired frequency in the range of 118 to 136 MHz, or 162 MHz.
 k = desired frequency in kHz where k = (desired frequency / 25 kHz) + 30h, with the desired frequency in the range of 000 to 975 kHz in 25 kHz steps, or 0 to 39.

Example Message

\$PMRRC0511IT64<cr>

The above example message outputs a ground frequency type, 121.900 MHz.

B.2.1.4.3 Remote VOR List

The following two commands work together in allowing the GNS 480 to provide a list of VOR frequencies to a remote device (such as the SL30). The GNS 480 will send a sequence of Remote VOR Input commands (message identifier 20). When all of the VOR Input commands have been sent, the GNS 480 will send a Remote VOR List Trailer command (message identifier 21) to terminate the list. The transmitted list should not be considered complete by remote device until it receives the trailer message. The remote device should maintain a single remote VOR list, so each list transmitted will replace any previous list. There may be up to twenty entries in the remote VOR list.

B.2.1.4.3.1 Remote VOR Output

This output is used to provide VOR frequency data that is used for the remote recall function.

The data consists of five characters for the VOR station identifier followed by two characters defining the VOR frequency.

Message format:

“V”	Message Class. This is a VHF NAV message.
“20”	Message Identifier.
vvvv	VOR station identifier. Note that if the station identifier is less than four characters, then the trailing characters will be filled with spaces. Station Identifiers are restricted to using ASCII characters 0-9 and A-Z.
mk	Frequency: m = MHz, where m = desired MHz frequency – 30h, with the desired frequency ranging from 108 to 117, or 3Ch to 45h; k = kHz, where k = (desired kHz offset / 25 kHz) + 30h, with desired frequency range of 000 to 950 kHz in 50 kHz steps, or the even numbers from 30h to 56h. Note that the field will be checked to ensure that it is in range and a valid VOR frequency. Frequencies used for localizers, which are in the range of 108.10 to 111.95 MHz, will not be accepted in this message type.

Example message:

```
$PMRRV20UBG<Sp>E@<chksm><CR><LF>
```

VOR station identifier is “UBG ”, VOR frequency is 117.400 MHz.

B.2.1.4.3.2 Remote VOR List Trailer

This output command marks the end of a VOR list sent by the GNS 480.

Message format:

“V”	Message Class. This is a VHF NAV message.
“21”	Message Identifier

Example message:

```
$PMRRV21<chksm><CR><LF>
```

Indicates the start of a remote VOR list.

B.2.1.4.4 Remote Localizer List

The following two commands work together in allowing the GNS 480 to provide a list of localizer frequencies associated with an airport to a remote device (such as the SL30). The GNS 480 will first send the Remote Localizer List Header command (message identifier 22), followed by a sequence of Remote

Localizer Input commands (message identifier 23). The remote device should maintain a single remote localizer list, so each new list received will replace any previous list. Subsequent receptions of localizer lists for the same airport may be ignored. There may be up to twenty entries in the remote Localizer list.

B.2.1.4.4.1 Remote Localizer List Header

This output command marks the beginning of a Localizer list sent by the GNS 480. It specifies the five character airport identifier associated with the localizer frequencies in the list.

Message format:

- “V” Message Class. This is a VHF NAV message.
- “22” Message Identifier.
- aaaa Airport identifier. Note that if the airport identifier is less than four characters, then the trailing characters will be filled with spaces. Airport Identifiers are restricted to using ASCII characters 0-9 and A-Z.

Example message:

```
$PMRRV22SLE<Sp><chksum><CR><LF>
```

Indicates the start of a remote localizer list associated with the airport “SLE ”.

B.2.1.4.5 Remote Localizer Input

This output is used to provide Localizer frequency data that is used for the remote recall function.

The data consists of three characters to identify the runway associated with the localizer, followed by two characters defining the frequency.

Message format:

- “V” Message Class. This is a VHF NAV message.
- “23” Message Identifier.
- iiii Station or Runway identifier. This field will provide an identifier for the localizer which can be either the actual station identifier or a string indicating the runway associated with the localizer. The station identifier can be up to four characters long. A runway identifier will typically be two numbers that indicate the runway direction followed by the character “R”, “C”, or “L” to differentiate between parallel runways (right, center, and left). Note that if either type of identifier is less than four characters, then the trailing characters will be filled in with spaces. Identifiers are restricted to using ASCII characters 0-9 and A-Z.
- mk Frequency: m = MHz, where m = MHz frequency – 30h, with the desired frequency ranging from 108 to 111 MHz, or 3Ch to 3Fh; k = (desired kHz offset / 25 kHz) + 30h, where the desired frequency ranges from 000 to 950 kHz, or the even numbers from 30h to 56h. Note that the field will be checked to ensure that it is in range and a valid localizer frequency. Frequencies used for VORs, which can also be found in the range of 108.10 to 111.95 MHz, will not be accepted in this message type.

Example message:

```
$PMRRV2331<Sp><Sp><<chksm><CR><LF>
```

Identifier is “31 ”, indicating a runway, and the localizer frequency is 110.300 MHz.

B.2.1.4.6 Distance/Speed/Time Message

If an SL30 is connected to the GNS 480, the GNS 480 will send the following message to the SL30.

```
$PMRRV41rrrrssshmm<CHECKSUM><CR><LF>
```

rrrr is the distance to the station in 0.1nm units
 sss is the ground speed in knots
 hmm is the time to the station in hours and minutes

This message is used to output the range, ground speed, and ETA decoded from an external RNAV sensor (DME or GPS).

Message format:

“V”Message class. This is a VHF NAV message.

“41”Message identifier.

rrrrRange from DME station in 1/10th of a nautical mile units. The first two digits are the 10s and 1s place of the range, and the last digit is the 1/10ths place. This field may range in value from 0.0 NM (“0000”) to 999.9 NM (“9999”). If the distance from the DME station is greater than 999.9NM, the value should be encoded as “----”.

sssGround speed with respect to DME station in knots. This field may range in value from 0 knots (“000”) to 999 knots (“999”). If the ground speed with respect to the DME station is greater than 999 knots, the value should be encoded as “---”.

hmm.....Time to station in hours and minutes. This field may range in value from 0 hours and 0 minutes (“000”) to 9 hours and 59 minutes (“959”). If the time to the station is greater than 9 hours and 59 minutes, the value should be encoded as “---”.

Example message:

```
$PMRRV410983055147<chksm><CR><LF>
```

Range from DME station is 98.3 NM, ground speed with respect to station is 55 knots, and the estimated time to the station is 1 hour and 47 minutes.

NOTES

APPENDIX C - EQUIPMENT COMPATIBILITY

C.1 ALTITUDE SOURCES

The following altitude sources are compatible with the GNS 480. Other altitude data sources may be used provided they meet the serial specifications defined in B.1.1 or provide the ARINC 429 labels defined in 2.8.10.2.1.

Manufacturer	Model	Data Format	Notes
Trans-Cal	SSD120	RS232	High resolution (10 ft) encoder (1200 baud)
ICARUS	3000U	RS232	Low resolution (100 ft) serializer (1200 baud)
Sandia Aerospace	SAE5-35	RS232	High resolution (10 ft) encoder (1200 baud)
Garmin AT	SL70 / SL70R	RS232	If the SL70 is provided with gray code altitude from any standard encoder, the SL70 will transmit altitude data (100 ft resolution) to the GNS 480. For the SL70, altitude data is provided to the GNX 480 on serial port 6 configured for SL70.
Garmin	GTX 33 / GTX 330	RS232	If the GTX 33/330 is provided with gray code altitude from any standard encoder, the GTX 33/330 will transmit altitude data (100 ft resolution) to the GNS 480. For the GTX 33/330, altitude data is provided to the GNS 480 on serial port 6 configured for GTX33 OR GTX33+TIS. The GTX 33/330 must have software version 3.06 or higher.
B & D Instruments	90004	ARINC 429	Low-speed
Shadin	8800-M	RS232	High resolution (1 ft) encoder (1200 baud)
Shadin	8800-T	RS232	High resolution (1 ft) encoder (9600 baud)

C.2 FUEL/AIR DATA COMPUTERS

The following fuel/air data computers are compatible with the GNS 480. Other fuel/air data sources may be used provided they meet the serial specifications defined in B.1.2.

Manufacturer	Model	Data Format	Notes
Shadin	F/ADC-200 F/ADC-2000 DigiData	RS232	[1]
Shadin	Digiflo-L Miniflo-L Microflo-L	RS232	Fuel data only
JP Instruments	FS-450	RS232	Fuel data only
JP Instruments	EDM-700/800	RS232	Fuel Flow option (Fuel data only)

- [1] If it is desired to have the F/ADC calculate wind data, ground speed and track angle must be provided to the FADC using a GNS 480 MAPCOM RS232 output. If the MAPCOM data is not supplied to the FADC, the GNS 480 will calculate wind data using other data supplied by the FADC.

C.3 HEADING SOURCES

The following heading sources are compatible with the GNS 480. Other heading sources may be used provided they meet the provide the ARINC 429 labels defined in section 2.8.10.2.1 or provide standard XYZ synchro data.

Manufacturer	Model	Interface	Notes
Litef	LCR-92/93	ARINC 429	High-speed
Litton	LTN-92	ARINC 429	High-speed
Century Flight Systems	1D755	Synchro	Bootstrap output from HSI
Sandel Avionics	SN3308	ARINC 429	Low-speed
Bendix/King	KCS55/KI525A	Synchro	Bootstrap output

C.4 ALTIMETERS FOR BARO CORRECTION

The following altimeters are compatible with the GNS 480. Other altimeters may be used to provide baro correction to the GNS 480 provided they have a potentiometer with a minimum resistance of 5 kΩ.

Manufacturer	Model	Notes
Bendix/King	KEA-130A KEA-346	
Kollsman	44929-935 24929-519 thru 532	
Aerosonic	10420-11968E	
United Instruments	5506-S(03-())	

C.5 AUTOPILOTS

The following autopilots are compatible with the GNS 480. Other autopilots may be used with the GNS 480 provided that they have a Nav mode and accept analog deviation data and flags meeting the specifications defined in section 1.3.9.1.1.

Manufacturer	Model	Interface	Notes
S-TEC	System 20/30/40/50/60-1/60-2/60 PSS/65	Analog deviation	
S-TEC	System 55X	Analog deviation, ARINC 429 GPSS	
S-TEC	ST-901	ARINC 429 GPSS	GPSS Roll Steering Converter
Century	I / II / III / IV 21 / 31 / 41 2000 Triden	Analog Deviation	
Bendix/King	KAP 100/150 KFC 200/225/300/325 KCP 320	Analog Deviation	

C.6 ELECTRONIC HSI'S

The following EHSI's are compatible with the GNS 480. Other EHSI's or navigation displays may be used with the GNS 480 provided that they accept serial data in the format defined in B.2.1 or ARINC 429 data as defined in 2.8.10.2.2.

Manufacturer	Model	Interface	Notes
Sandel Avionics	SN3308	Analog deviation and RS232	Low-speed

C.7 TRAFFIC ADVISORY SYSTEMS

The following traffic advisory systems are compatible with the GNS 480.

Manufacturer	Model	Interface	Notes
Garmin	GTX 33 / GTX 330	RS232	
Goodrich Avionics	SKY 497 SKY 899	ARINC 429 and optional discretes for mode control	The SKY 497 must have software version 1.6 or higher.

C.8 CARBON MONOXIDE DETECTOR SYSTEMS

The following carbon monoxide detector systems are compatible with the GNS 480.

Manufacturer	Model	Interface	Notes
CO Guardian	Aero 452 Aero 553	RS232	

NOTES

APPENDIX D - INTERCONNECT DIAGRAMS

NOTES

Rev	Date	Description
A	10/25/03	Updated company name to Garmin AT in block 6 and fixed Notes format error
B	10/25/03	Updated company name to Garmin AT in block 6 and fixed Notes format error

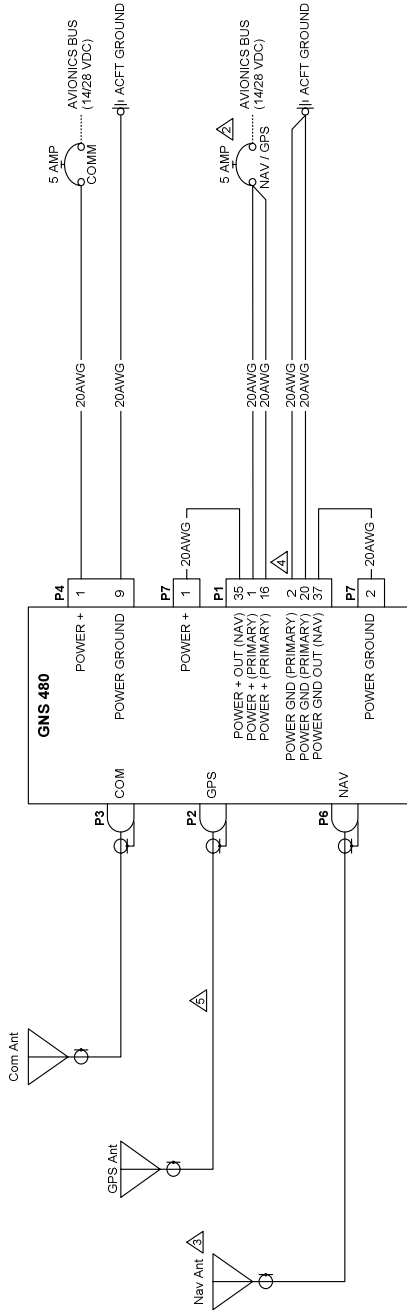

DUAL GNS 480 ANTENNA CONNECTIONS

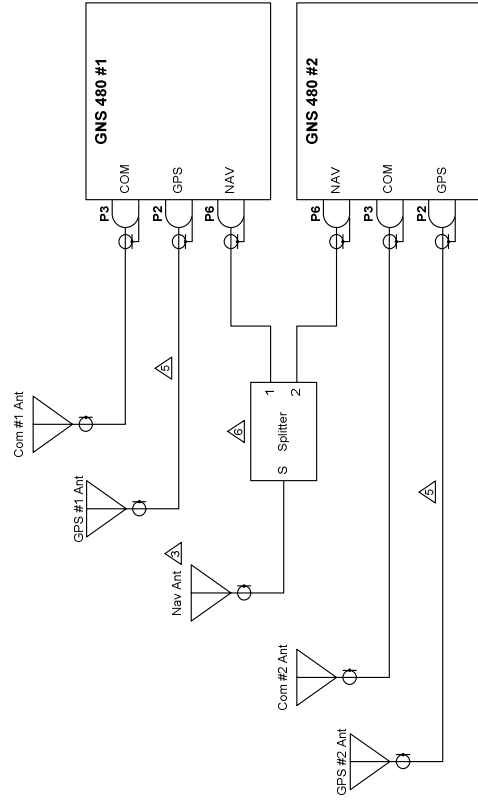

- NOTES:**
1. ALL WIRES 20 AWG FOR THE POWER AND GROUND CONNECTIONS.
 2. A MANUALLY RESETTABLE CIRCUIT BREAKER MUST BE USED FOR THE GNS 480 PRIMARY POWER INPUT.
 3. THE NAV ANTENNA MUST BE A COMBINED VOR/LOCALIZER SEPARATE FOR AND USE OF THE ANTENNAS ARE USED ON THE AIRCRAFT IS NOT RECOMMENDED.
 4. **CAUTION: TWO SETS OF PRIMARY POWER AND GROUND PINS ARE PROVIDED ON P1. BOTH SETS MUST BE CONNECTED TO THE AIRCRAFT POWER SOURCE TO AVOID DAMAGE TO THE UNIT.**
 5. THE GPS ANTENNA COAXIAL CABLE LOSS (INCLUDING CONNECTORS) MUST BE LESS THAN 7dB. FOR INSTALLATIONS LESS THAN 740B THE CABLE LOSS MUST BE GREATER THAN 3dB AND LESS THAN 4dB.
 6. GARMIN AT SPLITTER PIN 115-0007 (OR EQUIVALENT) MUST BE USED.

Garmin AT, Inc
 2345 Linden Road S.E., Salem, OR 97302
 503.584.0000
GNS 480 INSTALLATION DRAWING
 POWER AND ANTENNAS

Figure D- 1 - Main Power and Antenna Interconnect Diagram

This page intentionally left blank.

This page intentionally left blank.

Rev	Date	Description
A	05/2003	Change unit name to GNS 480

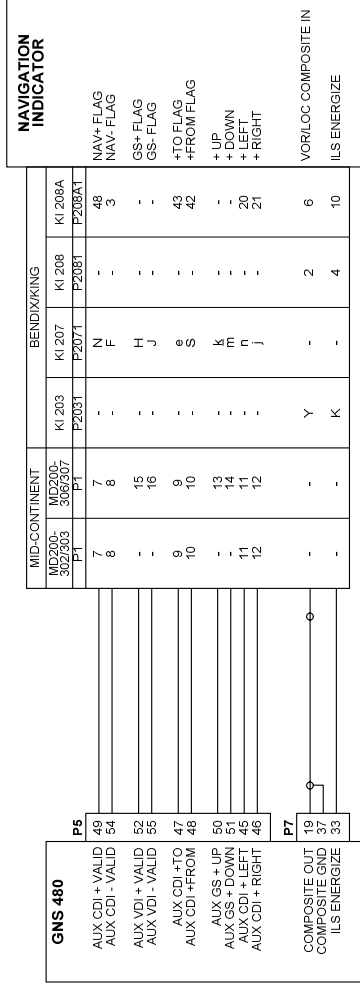

1. ALL WIRES 24 AWG OR LARGER UNLESS OTHERWISE SPECIFIED.
2. CONNECT SHIELD GROUNDS TO AIRCRAFT CHASSIS WITH AS SHORT A CONDUCTOR AS PRACTICAL.
3. THE AUX CDI OUTPUT IS ALWAYS BASED UPON GPS DATA. THE COMPOSITE OUTPUT IS ALWAYS BASED UPON VOR DATA.
4. OTHER EQUIVALENT PARTS MAY BE INTERFACED TO THE EQUIPMENT IF APPROPRIATE INSTALLATION MANUALS FOR THAT EQUIPMENT.

Garmin A.T. Inc
 2345 Tyler Road S.E. Salem, OR 97302
 Phone: 503-325-1011 Fax: 503-325-1001
 E-Mail: info@garmin.com

GNS 480 INSTALLATION DRAWING

AUX (GPS) CDI / VOR COMPOSITE

Figure D-3 - Auxiliary CDI Interconnect Diagram

This page intentionally left blank.

Rev	Date	Description
A	03/27/03	Initial Release
B	04/28/03	Changed XYZ Gyro pin to Heading Valid Out
C	05/20/03	Change wire bundle to GNS 480

TYPICAL CONNECTIONS TO ALTIMETER BARO POT

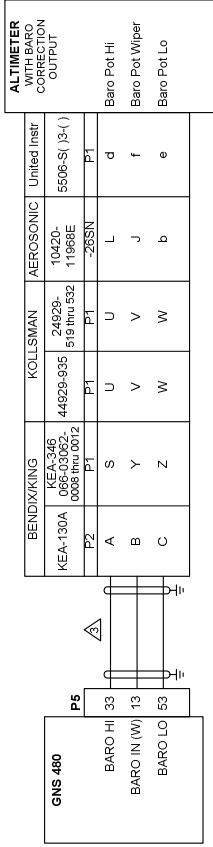

TYPICAL CONNECTIONS TO RMI

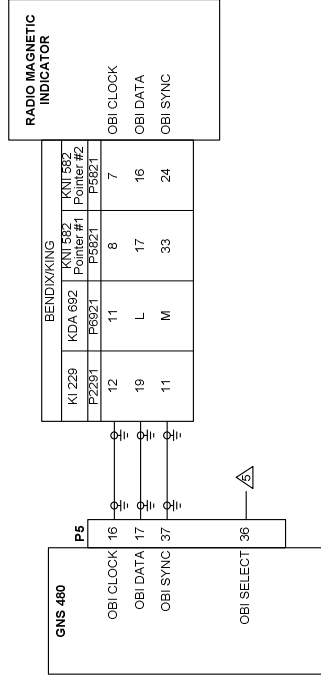

TYPICAL CONNECTIONS TO HEADING SYNCHRO

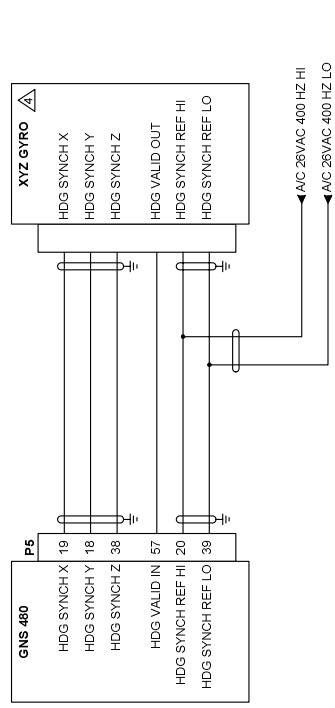

NOTES:

- ALL WIRES 24 AWG OR LARGER UNLESS OTHERWISE SPECIFIED
- AT GNS 480, CONNECT SHIELD GROUNDS TO THE REAR OF THE MOUNTING FRAME ON THE CONNECTOR PLATE - THE SHIELD GROUNDS TO AIRCRAFT CHASSIS WITH AS SHORT A CONDUCTOR AS PRACTICAL
- NO OTHER EQUIPMENT SHOULD BE WIRED IN PARALLEL ON THE BARO POTENTIOMETER INTERFACE
- A DIRECTIONAL GYRO OR HSI BOOTSTRAP OUTPUT MAY BE USED TO PROVIDE SYNCHRO HEADING TO THE GNS 480
- THE OBI SELECT INPUT TO THE GNS 480 CAN BE USED TO SELECT THIS INPUT IS OPEN, BEARING DATA IS DERIVED FROM THE GPS ; WHEN GROUNDED, BEARING DATA IS DERIVED FROM THE VOR.
- OTHER EQUIVALENT PARTS MAY BE INTERFACED TO THE GNS 480 IF APPROPRIATE INSTALLATION MANUALS FOR THAT EQUIPMENT.

Garmin AT, Inc
2345 Tyler Road S.E., Salem, OR 97302
503-575-2000
www.garmin.com

GNS 480 INSTALLATION DRAWING
BARO POTENTIOMETER /
SYNCHRO HEADING / RMI

Figure D-4 - Baro Potentiometer/Synchro Heading/RMI Interconnect Diagram

This page intentionally left blank.

This page intentionally left blank.

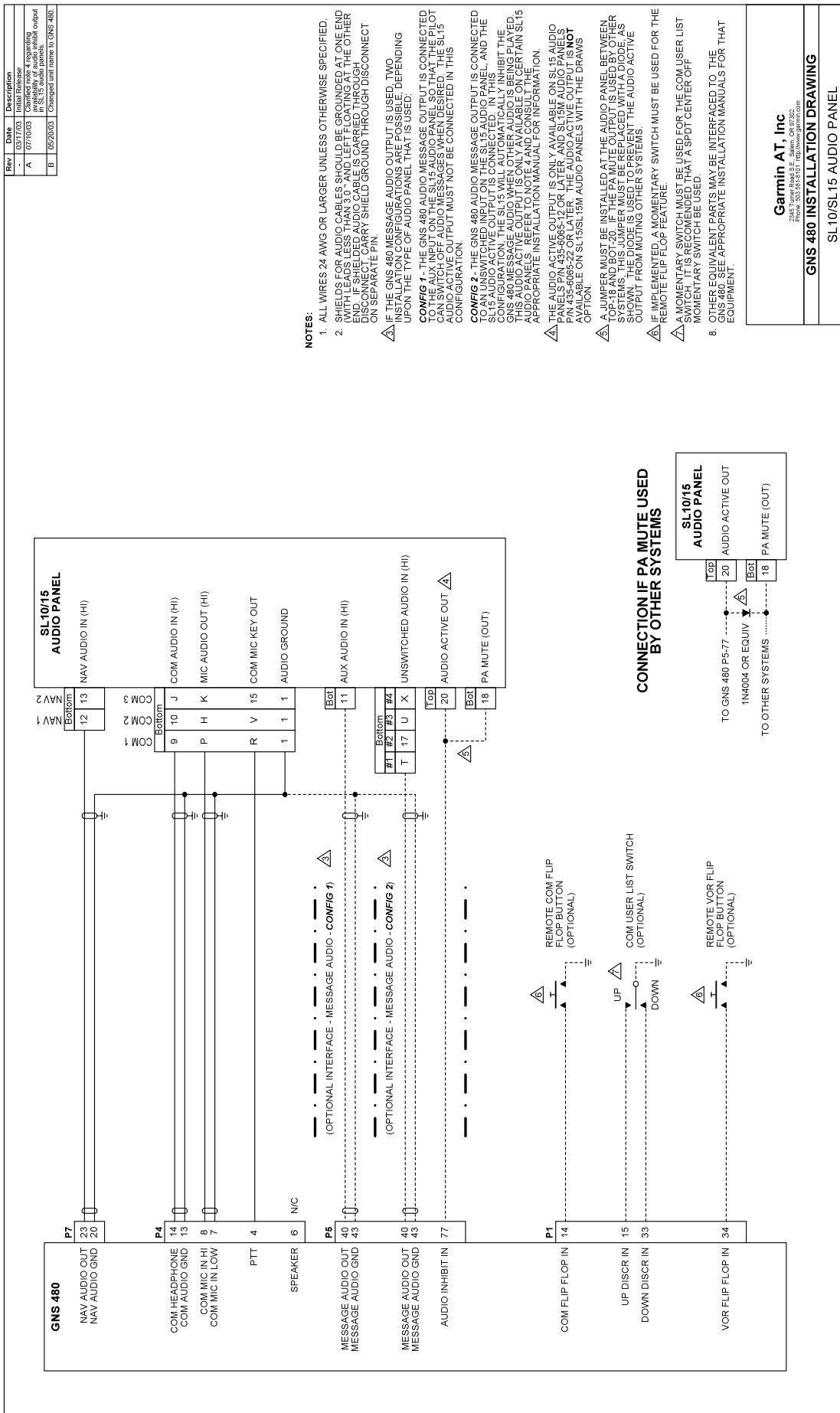

Figure D-6 - GNS 480 to SL10/15 Audio Panel Interconnect Diagram

This page intentionally left blank.

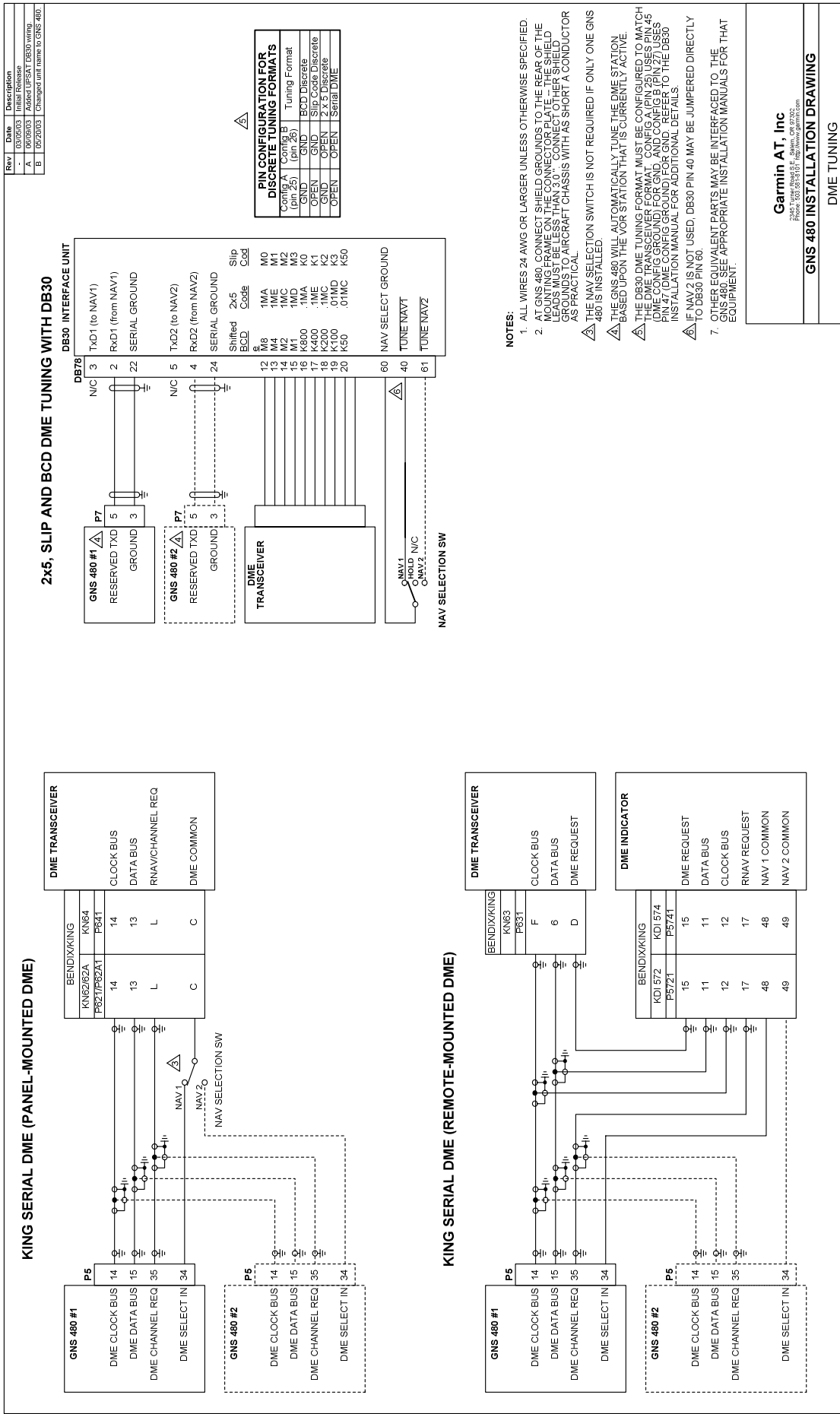
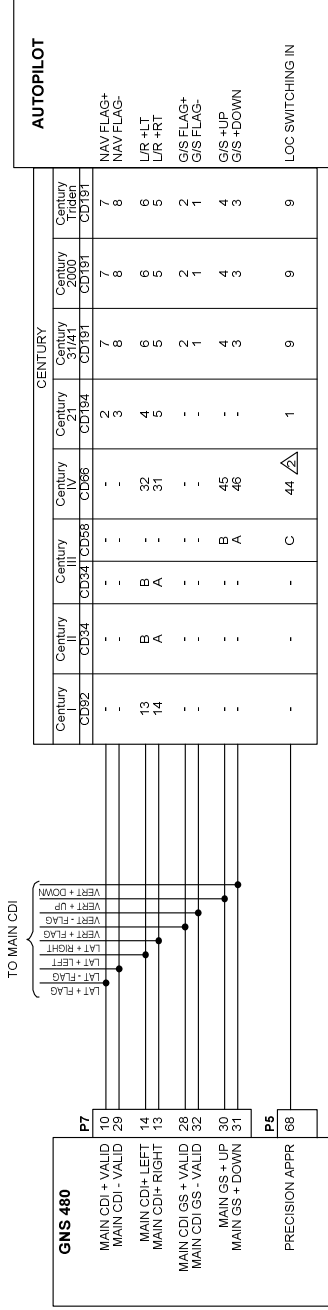

Figure D-7 - DME Tuning Interconnect Diagram

This page intentionally left blank.

This page intentionally left blank.

Rev	Date	Description
A	10/20/03	Initial Release
A	10/20/03	Change part number to GNS 480



CENTURY IV LOC SWITCHING CONNECTION

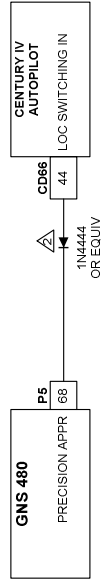

NOTES:

1. ALL WIRES 24 AWG OR LARGER UNLESS OTHERWISE SPECIFIED
2. THE CENTURY IV REQUIRES THAT AN ISOLATION DIODE BE INSTALLED ON THE LOC SWITCHING INPUT AS SHOWN.

Garmin A.T. Inc
 2345 Tyler Road S.E. Salem, OR 97302
 Phone: 503-251-1011 Fax: 503-251-1012
 www.garmin.com

GNS 480 INSTALLATION DRAWING

CENTURY AUTOPILOTS

Figure D-9 - Century Autopilot Interconnect Diagram

This page intentionally left blank.

Rev	Date	Description
1	07/03	Initial Release
A	07/01/03	Wiring for KAP 150 and KFC 200 Loc Shunting in
B	05/20/03	Change part name to GNS 400

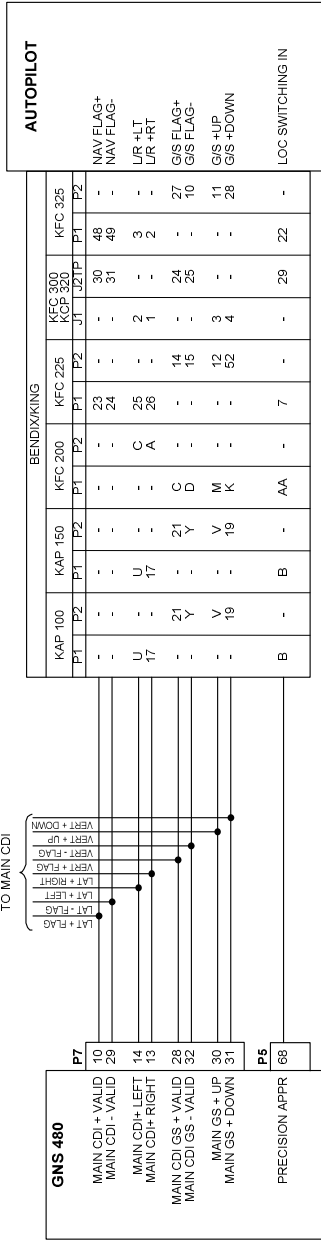

NOTES:
 1. ALL WIRES 24 AWG OR LARGER UNLESS OTHERWISE SPECIFIED

Garmin A.T. Inc
 2345 Tyler Road S.E. Salem, OR 97302
 Phone: 503-281-0101 Fax: 503-281-0102
<http://www.garmin.com>

GNS 480 INSTALLATION DRAWING

BENDIX/KING AUTOPILOTS

Figure D- 10 - Bendix/King Autopilot Interconnect Diagram

This page intentionally left blank.

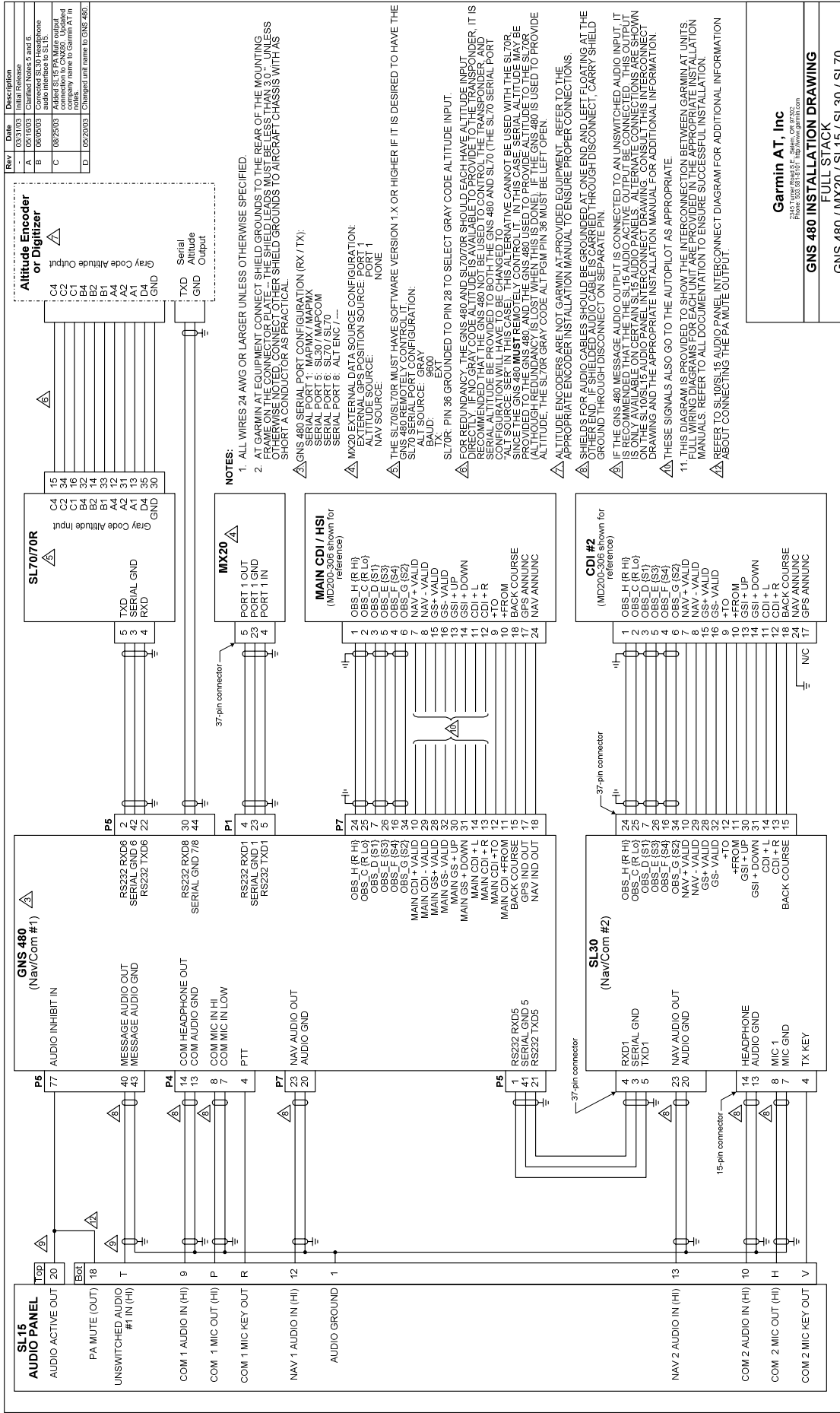

Figure D-11 - Single GNS 480 Full Stack Interconnect Diagram

This page intentionally left blank.

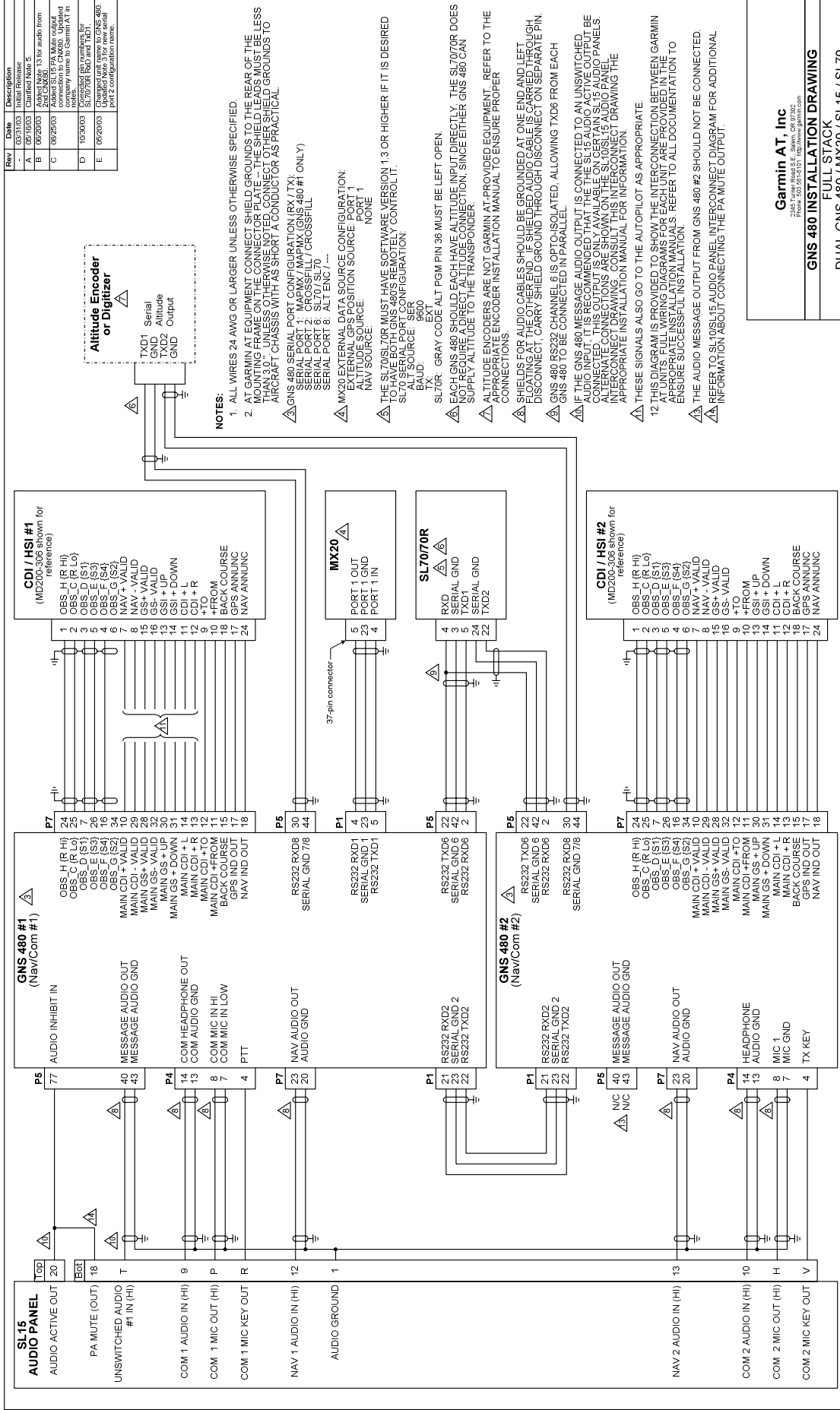
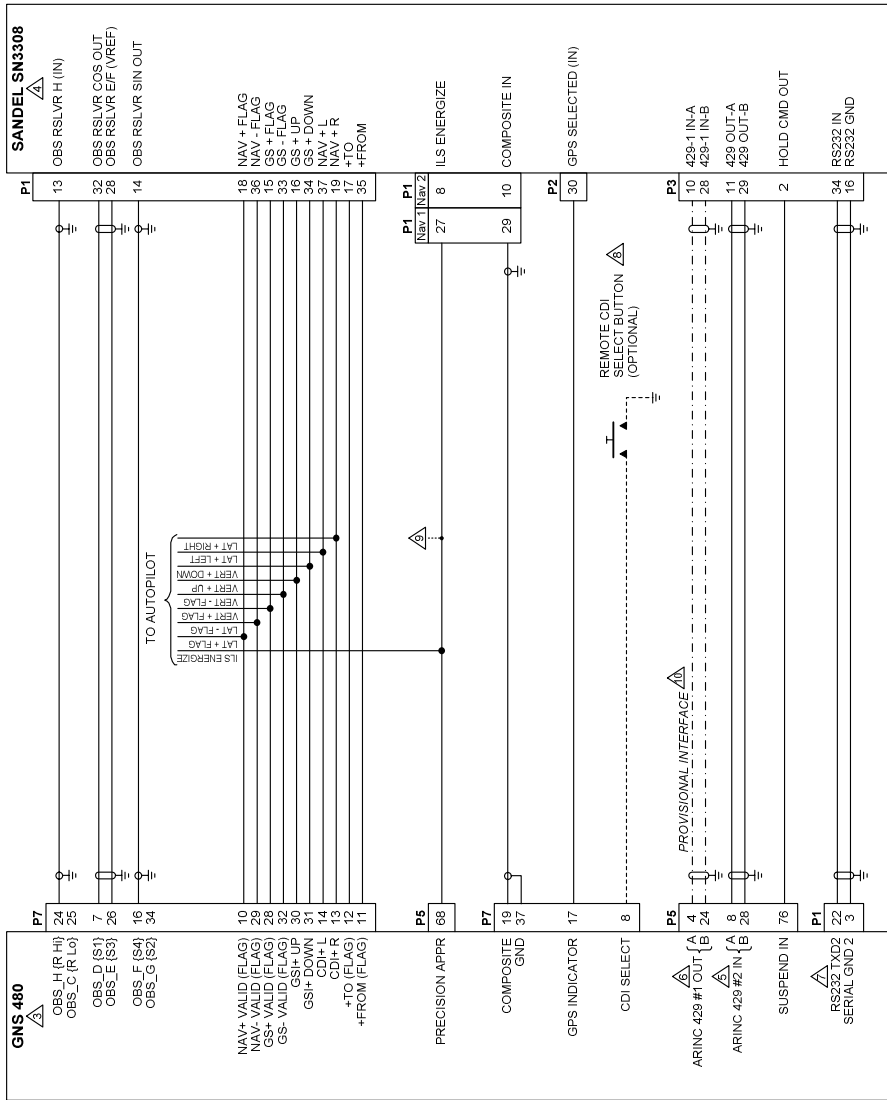

Figure D-12 - Full Stack with Dual GNS 480's Interconnect Diagram

This page intentionally left blank.

Rev	Date	Description
A	05/22/03	Initial Release
B	07/15/03	Changed ARINC 429 to #2 to the preferred input. Revised the connector pinout.
C	08/06/03	Changed CNX80 Precision APPR from P7-28 to P5-88.
D	05/20/03	Changed unit name to GNS 480.



NOTES:

1. ALL WIRES 24 AWG OR LARGER UNLESS OTHERWISE SPECIFIED.
 2. AT GNS 480, CONNECT SHIELD GROUNDS TO THE REAR OF THE MOUNTING FRAME ON THE CONNECTOR PLATE - THE SHIELD LEADS MUST BE LESS THAN 3" LONG. CONNECT SHIELD GROUNDS TO AIRCRAFT CHASSIS WITH AS SHORT A CONDUCTOR AS PRACTICAL.
- ⚠️ GNS 480 SERIAL PORT SETUP ITEMS
 SERIAL PORT 2: XXX / MAPCOM (9600)
 CH2 IN / AHSR LOW
 ARINC 429 SETUP:
- ⚠️ SANDEL SN3308 SETUP ITEMS
 NAV1/2 CHARGE / ANNING SERIAL CODES=DTK DEVIATION=ANALOG
 NAV1/2: NAV-1/2 ENABLE=YES PORT=ANALOG, ILS=VALID, LOW RELAY MODE=SLAVE
 RELAY SENSE: GPS-1/2=P2-30 (GPS 1 OR 2 AS APPROPRIATE)
- THIS ALLOWS THE GNS 480 TO CONTROL THE SELECTION OF THE NAV DETAILS. REFER TO SN3308 INSTALLATION MANUAL FOR ADDITIONAL DETAILS.
- ⚠️ THE GNS 480 CAN RECEIVE MAGNETIC HEADING FROM THE SN3308. ARINC 429 #1 IN (P5-7/27) MAY BE USED INSTEAD OF ARINC 429 #2 IN. IF ARINC 429 #1 INPUT IS USED INSTEAD, IT MUST BE SET TO RECEIVE ADC, LOW-SPEED DATA.
- ⚠️ ARINC 429 #2 OUT (P5-5/25) MAY BE USED INSTEAD OF ARINC 429 #1 OUT.
- ⚠️ RS232 TXD5 (P5-21/41) OR RS232 TXD1 (P1-5/23) MAY BE USED INSTEAD OF RS232 TXD3. THE TRANSMIT PORT THAT IS USED MUST BE SET TO XXX / MAPCOM (9600).
- ⚠️ IF IMPLEMENTED, A MOMENTARY SWITCH MUST BE USED FOR THE REMOTE COM FLIP FLOP FEATURE.
- ⚠️ USE OF THE GNS 480 PRECISION APPROACH DISCRETE (P5-68) WILL NOT ALLOW THE GLIDESLOPE INDICATOR TO BE DISPLAYED ON THE SANDEL. HOWEVER, THE GLIDESLOPE INDICATOR DISPLAY IS ALLOWED WHENEVER A LOCALIZER IS TUNED. P5-68 MUST BE MODE-ORD WITH THE ILS ENERGIZE DISCRETE OUTPUT (P7-33). THIS MUST BE DONE AFTER THE CONNECTION TO THE AUTOPILOT.
- ⚠️ THIS PROVISIONAL ARINC 429 INTERFACE IS NOT PRESENTLY USED. IT WILL BE REUTILIZED IN A FUTURE VERSION OF THE GNS 480 AND IT IS RECOMMENDED THAT IT BE INSTALLED AT THE TIME OF GNS 480 INSTALLATION.

Garmin AT, Inc

2345 Tyler Street, S.E., Salem, OR 97302

Phone: (503) 251-1010 Fax: (503) 251-1000

GNS 480 INSTALLATION DRAWING

SANDEL SN3308 NAVIGATION DISPLAY

Figure D-13 - GNS 480 to Sandel SN3308 Nav Display Interconnect Diagram

This page intentionally left blank.

Rev	Date	Description
A	09/03/04	Checked and Approved by GNS 480
A	09/03/04	Checked and Approved by GNS 480

MID-CONTINENT ACU CONNECTION

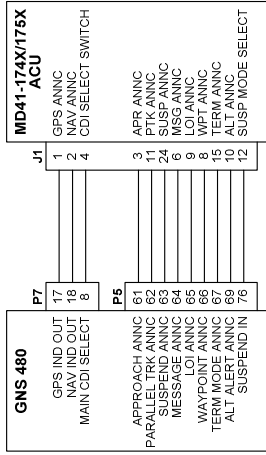

STACO INDICATOR CONNECTION

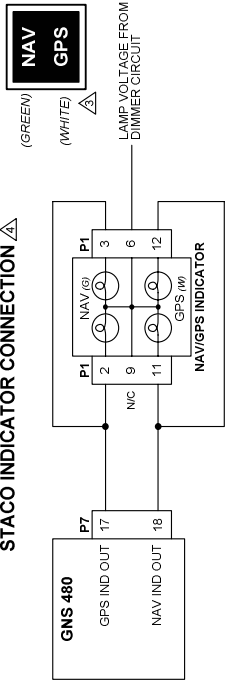

VIVISUN INDICATOR CONNECTION

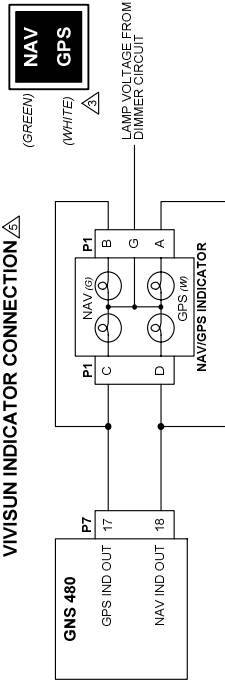

VIVISUN INDICATOR/SWITCH CONNECTION

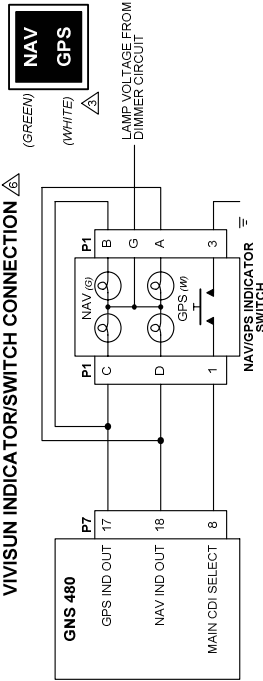

NAT INDICATOR CONNECTION

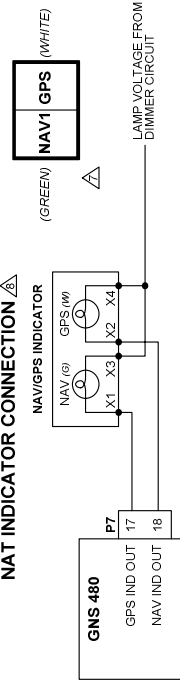

NOTES:

1. ALL WIRES 24 AWG OR LARGER UNLESS OTHERWISE SPECIFIED.
2. IF AC/DI/HSI SOURCE SELECTION ANNUNCIATOR IS REQUIRED, INDICATORS ON THIS PAGE ARE SUITABLE TO MEET THE ANNUNCIATION REQUIREMENT.
3. LEGENDS ARE HIDDEN (BLACK) WHEN NOT ILLUMINATED.
4. STACO SWITCH INDICATOR PIN 99-5921-224/752200 (14V SYSTEMS) AND PIN 99-2381-224/662200 (28V SYSTEMS) SHOWN.
5. VIVISUN INDICATOR PIN 95-4017-56-63816 (28V SYSTEMS) SHOWN. LAMPS WITH 14V LAMPS PIN 14-113.
6. VIVISUN INDICATOR WITH MOMENTARY SWITCH, PIN 95-45-11-86-63816 (28V SYSTEMS) SHOWN. INDICATOR MAY BE CONVERTED TO 14V OPERATION BY REPLACING 28V LAMPS WITH 14V LAMPS PIN 14-113.
7. TEXT IS BLACK AND ALWAYS VISIBLE. COLORED BACKGROUND IS ILLUMINATED WHEN SELECTED. NAV2 LEGEND IS ALSO AVAILABLE WITH BASIC SWITCH.
8. NAT INDICATOR PIN LL08-009 (28V SYSTEMS) SHOWN. INDICATOR MAY BE CONVERTED TO 14V OPERATION BY REPLACING 28V LAMPS PIN 388 WITH 14V LAMPS PIN 386.
9. MID-CONTINENT ANNUNCIATION CONTROL UNIT MD41-1748 (MD41-1748(X)/MD41-1750(X)) AND MD41-1751 (MD41-1751(X)) SYSTEMS SHOWN. THIS DIAGRAM IS PROVIDED TO SHOW INTERCONNECTION BETWEEN GNS 480 AND ACU ONLY. REFER TO MID-CONTINENT INSTALLATION MANUAL FOR ADDITIONAL INSTALLATION INFORMATION.

Garmin A.T. Inc

2345 Tyler Road S.E., Salem, OR 97302
Phone: 503-251-1010, Fax: 503-251-1011

GNS 480 INSTALLATION DRAWING

CDI/HSI SOURCE SELECT ANNUNCIATORS

Figure D-14 - GNS 480 to CDI/HSI Source Select Annunciators Interconnect Diagram

This page intentionally left blank.

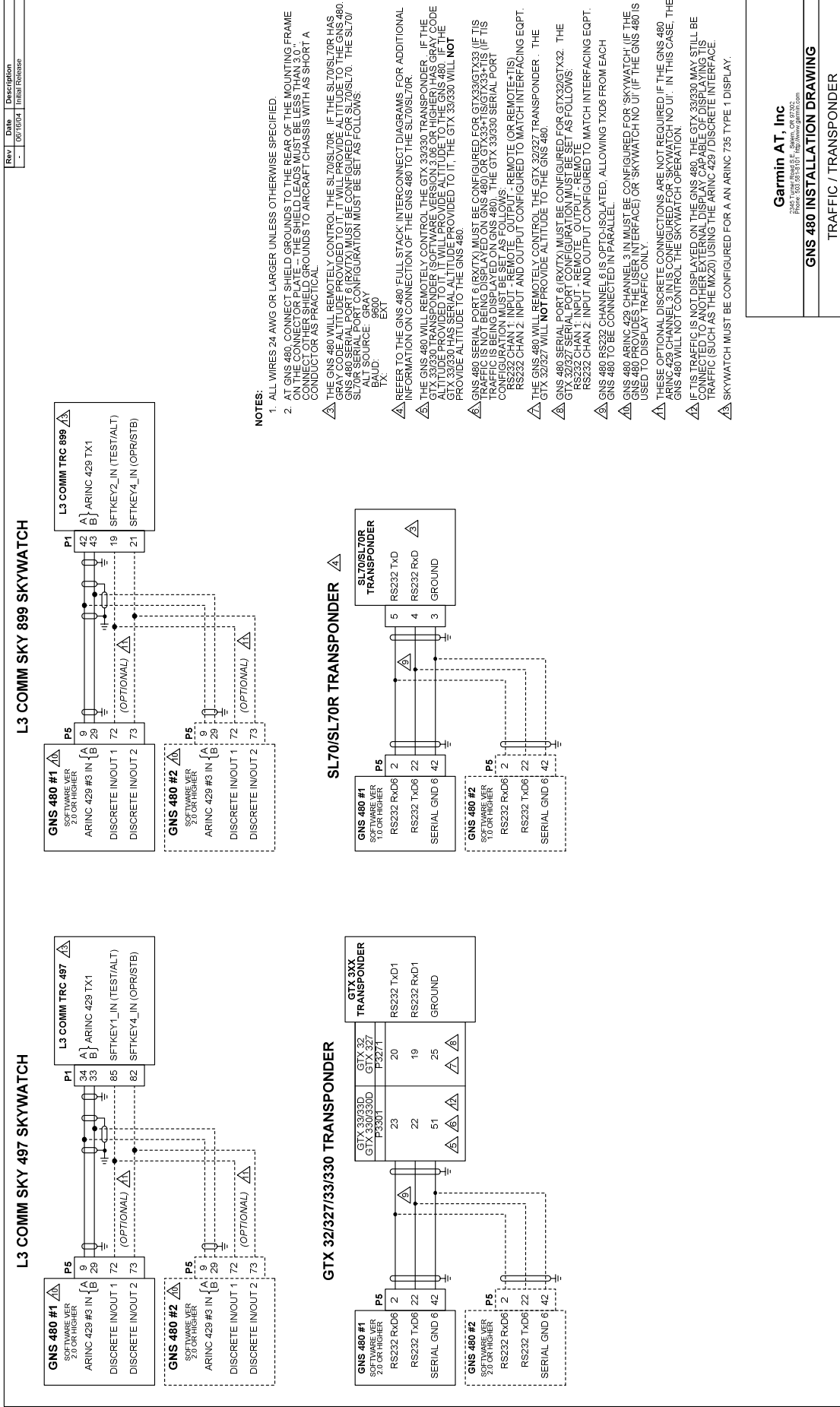

Figure D-15 - GNS 480 to Traffic System and Transponder Interconnect Diagram

Rev	Date	Description
-	08/10/04	Initial Release

NOTES:

1. ALL WIRES 24 AWG OR LARGER UNLESS OTHERWISE SPECIFIED.
2. AT GNS 480, CONNECT SHIELD GROUNDS TO THE REAR OF THE MOUNTING FRAME AND CONNECT OTHER SHIELD GROUNDS TO AIRCRAFT CHASSIS WITH AS SHORT A CONDUCTOR AS PRACTICAL.
- △ THE GNS 480 WILL REMOTELY CONTROL THE SL70/SL70R. IF THE SL70/SL70R HAS GRAY CODE ALTIMETER PROVIDED TO IT, IT WILL PROVIDE ALTIMETER TO THE GNS 480. GNS 480 SERIAL PORT 6 (RVITX) MUST BE CONFIGURED FOR SL70/SL70. THE SL70/SL70R SERIAL PORT 6 (RVITX) MUST BE CONFIGURED FOR SL70/SL70. THE SL70/SL70R ALTIMETER MUST BE SET AS FOLLOWS:
 - EAUD: 5600
 - EXT
- △ REFER TO THE GNS 480 FULL STACK INTERCONNECT DIAGRAMS FOR ADDITIONAL INFORMATION ON CONNECTION OF THE GNS 480 TO THE SL70/SL70R.
- △ THE GNS 480 WILL REMOTELY CONTROL THE GTX 32/327 TRANSPONDER. IF THE ALTIMETER PROVIDED UNDER (OPTIONAL) IS PROVIDED TO THE GNS 480, SET THE GTX 33/330 HAS SERIAL ALTIMETER PROVIDED TO IT, THE GTX 33/330 WILL NOT PROVIDE ALTIMETER TO THE GNS 480.
- △ GNS 480 SERIAL PORT 6 (RVITX) MUST BE CONFIGURED FOR GTX33/GTX33 (IF ITS TRAFFIC IS NOT BEING DISPLAYED ON GNS 480) OR GTX33+ITS/GTX33+ITS (IF ITS TRAFFIC IS BEING DISPLAYED ON GNS 480). THE GTX 33/330 SERIAL PORT CONFIGURATION MUST BE SET AS FOLLOWS:
 - RS232 CHAN 1 - INPUT - REMOTE OUTPUT - REMOTE (OR REMOTE+ITS)
 - RS232 CHAN 2 - INPUT AND OUTPUT CONFIGURED TO MATCH INTERFACING EQPT.
- △ THE GNS 480 WILL REMOTELY CONTROL THE GTX 32/327 TRANSPONDER. THE GTX 32/327 WILL NOT PROVIDE ALTIMETER TO THE GNS 480.
- △ GNS 480 SERIAL PORT 6 (RVITX) MUST BE CONFIGURED FOR GTX32/GTX32. THE GTX 32/327 SERIAL PORT CONFIGURATION MUST BE SET AS FOLLOWS:
 - RS232 CHAN 1 - INPUT AND OUTPUT CONFIGURED TO MATCH INTERFACING EQPT.
 - RS232 CHAN 2 - INPUT AND OUTPUT CONFIGURED TO MATCH INTERFACING EQPT.
- △ GNS 480 RS232 CHANNEL 6 IS OPTO ISOLATED, ALLOWING TXD6 FROM EACH GNS 480 TO BE CONNECTED IN PARALLEL.
- △ GNS 480 ARINC 429 CHANNEL 3 IN MUST BE CONFIGURED FOR SKYWATCH. IF THE GNS 480 PROVIDES THE USER INTERFACE OR SKYWATCH NO UI (IF THE GNS 480 IS USED TO DISPLAY TRAFFIC ONLY).
- △ THESE OPTIONAL DISCRETE CONNECTIONS ARE NOT REQUIRED IF THE GNS 480 ARINC 429 CHANNEL 3 IN IS CONFIGURED FOR SKYWATCH NO UI. IN THIS CASE, THE GNS 480 WILL NOT CONTROL THE SKYWATCH OPERATION.
- △ IF ITS TRAFFIC IS NOT DISPLAYED ON THE GNS 480, THE GTX 33/330 MAY STILL BE CONNECTED TO ANOTHER EXTERNAL DISPLAY CAPABLE OF DISPLAYING ITS TRAFFIC (SUCH AS THE MAX20) USING THE ARINC 429 / DISCRETE INTERFACE.
- △ SKYWATCH MUST BE CONFIGURED FOR A AN ARINC 735 TYPE 1 DISPLAY.

Garmin A.T. Inc

2345 Tyler Road S.E., Salem, OR 97302

Phone: 503-351-0101 Fax: 503-351-0100

GNS 480 INSTALLATION DRAWING

TRAFFIC / TRANSPONDER

This page intentionally left blank.

APPENDIX E - ACCEPTABLE AIRCRAFT BY EVALUATION

In certain instances, aircraft on the Approved Model List have a center radio stack located outside of the acceptable field-of-view defined herein. For these particular installations, additional FAA approval will be required. Below is a listing of such aircraft that have already been evaluated by the FAA and determined to be acceptable. No further approval will be required for these aircraft provided the criteria in the Installation Requirements column are satisfied by the installation.

Aircraft Make and Model Designation	Installation Requirements
Raytheon (Beech)	
E33, E33A, E33C, F33, F33A, F33C, G33	The GNS 480 must be installed in the manufacturer's provided avionics stack. External CDI/HSI source selection annunciation is required. The CDI/HSI source select annunciation must be installed in accordance with 2.5.3.2.
35-B33, 35-C33, 35-C33A, P35, S35, V35, V35A, V35B	The GNS 480 must be installed in the manufacturer's provided avionics stack. External CDI/HSI source selection annunciation is required. The CDI/HSI source select annunciation must be installed in accordance with 2.5.3.2.
36, A36, A36TC, B36TC	The GNS 480 must be installed in the manufacturer's provided avionics stack. External CDI/HSI source selection annunciation is required. The CDI/HSI source select annunciation must be installed in accordance with 2.5.3.2.
D55, D55A, E55, E55A	The GNS 480 must be installed high enough in the manufacturer's provided avionics stack so that there is a clear, unobstructed view of the display. External CDI/HSI source selection annunciation is required. The CDI/HSI source select annunciation must be installed in accordance with 2.5.3.2.
56TC, A56TC	The GNS 480 must be installed high enough in the manufacturer's provided avionics stack so that there is a clear, unobstructed view of the display. External CDI/HSI source selection annunciation is required. The CDI/HSI source select annunciation must be installed in accordance with 2.5.3.2.
58, 58A, 58P, 58PA, 58TC, 58TCA	The GNS 480 must be installed high enough in the manufacturer's provided avionics stack so that there is a clear, unobstructed view of the display. External CDI/HSI source selection annunciation is required. The CDI/HSI source select annunciation must be installed in accordance with 2.5.3.2.
95, 95-55, 95-A55, 95-B55, 95-B55A, 95-C55, 95-C55A, B95, B95A, D95A, E95	The GNS 480 must be installed high enough in the manufacturer's provided avionics stack so that there is a clear, unobstructed view of the display. External CDI/HSI source selection annunciation is required. The CDI/HSI source select annunciation must be installed in accordance with 2.5.3.2.

NOTES

APPENDIX F – OPTIONAL ACCESSORIES NOT SUPPLIED

F.1 CDI/HSI SOURCE SELECTION ANNUNCIATORS

A CDI/HSI Source Selection Annunciator may be required for some installations – refer to 2.5.3.2 for additional information describing when a source selection annunciator is required. The following indicators and indicator/switches are suitable for source selection annunciation:

Manufacturer	Part Number	Type	Notes
Staco Switch	992561-1241762200	Indicator	14VDC Indicator
Staco Switch	992561-1241862200	Indicator	28VDC Indicator
Vivisun	95-40-17-B6-63816	Indicator	28VDC Indicator (can be converted to 14VDC operation by replacing qty 4 28VDC lamps with 14VDC lamps P/N 14-113).
Vivisun	95-45-11-B6-63816	Indicator/ Switch	28VDC Indicator with momentary switch (can be converted to 14VDC operation by replacing qty 4 28VDC lamps with 14VDC lamps P/N 14-113).
NAT	LL08-009	Indicator	28VDC Indicator (can be converted to 14VDC operation by replacing qty 2 28VDC lamps P/N 388 with 14VDC lamps P/N 386).
Mid-Continent	MD41-1748 MD41-1748(5V) MD41-1758 MD41-1758(5V) MD41-1744 MD41-1754	Indicator/ Switch	Both 14VDC and 28VDC indicators with momentary switches for remote CDI selection and suspend.

Vendor Contact Information (provided for convenience only):

- Staco Switch, 1139 Baker Street Costa Mesa, CA 92626 USA, ph (714) 549-3041.
- Vivisun Aerospace Optics, 3201 Sandy Lane Fort Worth, Texas 76112, ph 1-888-VIVISUN.
- Northern Airborne Technology Ltd. (NAT), #14-1925 Kirschner Road, Kelowna, BC, Canada, ph (250) 763-2232.
- Mid-Continent Instrument Co Inc., 9400 E. 34th Street N., Wichita, KS 67226, ph (316) 630-0101

NOTES

